

# DATA SHEET

## **BF998; BF998R** Silicon N-channel dual-gate MOS-FETs

Product specification  
Supersedes data of April 1991  
File under Discrete Semiconductors, SC07

1996 Aug 01

**Silicon N-channel dual-gate MOS-FETs**

**BF998; BF998R**

**FEATURES**

- Short channel transistor with high forward transfer admittance to input capacitance ratio
- Low noise gain controlled amplifier up to 1 GHz.

**APPLICATIONS**

- VHF and UHF applications with 12 V supply voltage, such as television tuners and professional communications equipment.

**DESCRIPTION**

Depletion type field effect transistor in a plastic microminiature SOT143 or SOT143R package with source and substrate interconnected. The transistors are protected against excessive input voltage surges by integrated back-to-back diodes between gates and source.

**CAUTION**

The device is supplied in an antistatic package. The gate-source input must be protected against static discharge during transport or handling.

**PINNING**

PIN	SYMBOL	DESCRIPTION
1	s, b	source
2	d	drain
3	g <sub>2</sub>	gate 2
4	g <sub>1</sub>	gate 1

**QUICK REFERENCE DATA**

SYMBOL	PARAMETER	CONDITIONS	TYP.	MAX.	UNIT
V <sub>DS</sub>	drain-source voltage		–	12	V
I <sub>D</sub>	drain current		–	30	mA
P <sub>tot</sub>	total power dissipation		–	200	mW
y <sub>fs</sub>	forward transfer admittance		24	–	mS
C <sub>ig1-s</sub>	input capacitance at gate 1		2.1	–	pF
C <sub>rs</sub>	reverse transfer capacitance	f = 1 MHz	25	–	fF
F	noise figure	f = 800 MHz	1	–	dB
T <sub>j</sub>	operating junction temperature		–	150	°C

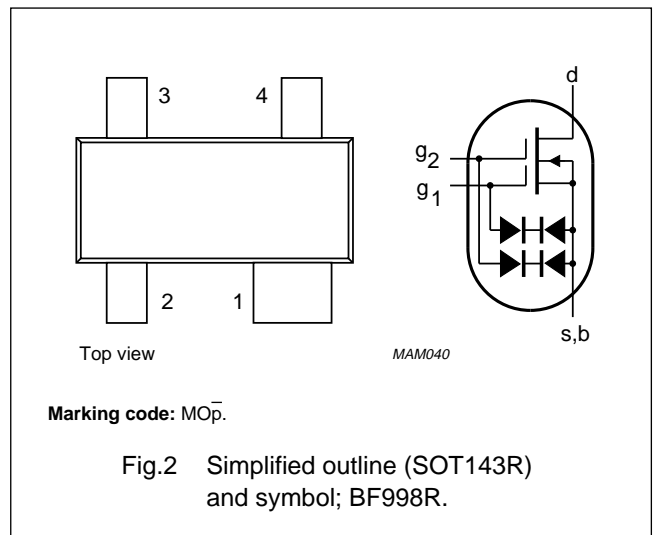
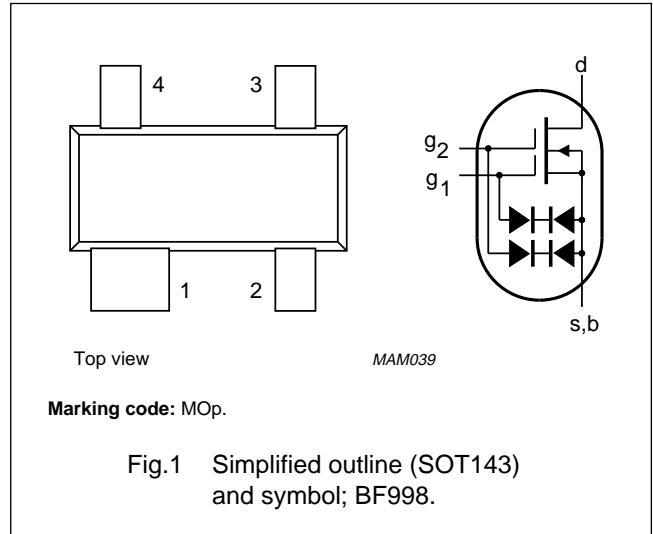

Silicon N-channel dual-gate MOS-FETs

BF998; BF998R

**LIMITING VALUES**

In accordance with the Absolute Maximum Rating System (IEC 134).

SYMBOL	PARAMETER	CONDITIONS	MIN.	MAX.	UNIT
$V_{DS}$	drain-source voltage		–	12	V
$I_D$	drain current		–	30	mA
$\pm I_{G1}$	gate 1 current		–	10	mA
$\pm I_{G2}$	gate 2 current		–	10	mA
$P_{tot}$	total power dissipation; BF998	up to $T_{amb} = 60\text{ }^\circ\text{C}$ ; see Fig.3; note 1	–	200	mW
		up to $T_{amb} = 50\text{ }^\circ\text{C}$ ; see Fig.3; note 2	–	200	mW
$P_{tot}$	total power dissipation; BF998R	up to $T_{amb} = 50\text{ }^\circ\text{C}$ ; see Fig.4; note 1	–	200	mW
$T_{stg}$	storage temperature		–65	+150	$^\circ\text{C}$
$T_j$	operating junction temperature		–	150	$^\circ\text{C}$

**Notes**

1. Device mounted on a ceramic substrate, 8 mm × 10 mm × 0.7 mm.
2. Device mounted on a printed-circuit board.

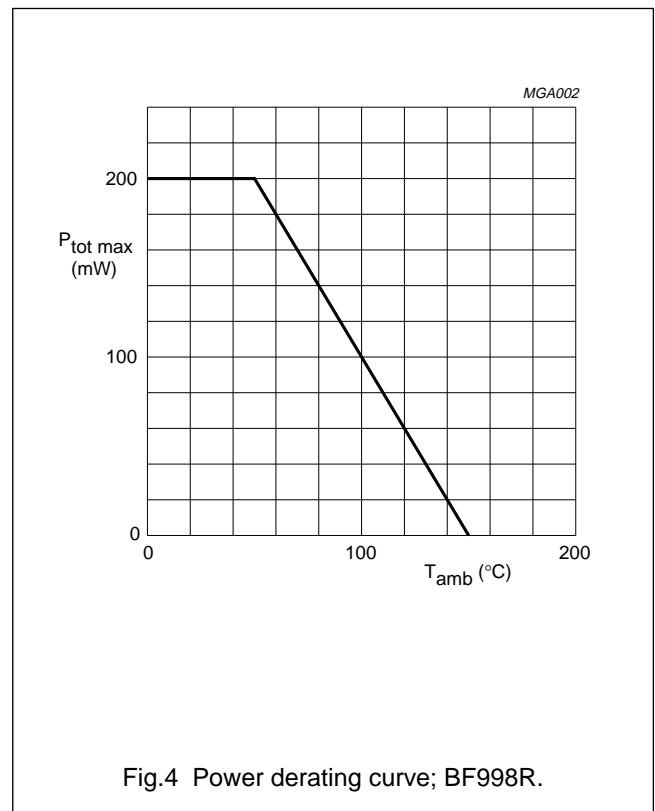
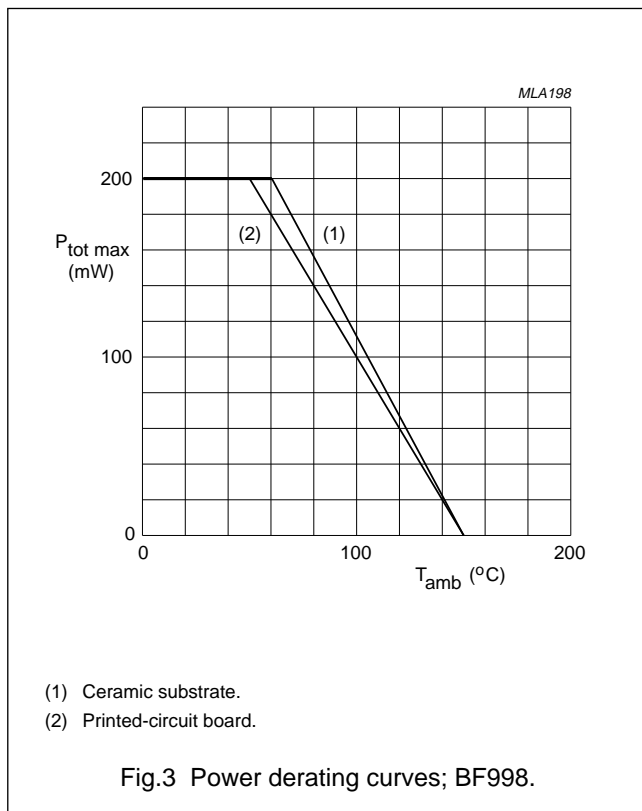

## Silicon N-channel dual-gate MOS-FETs

## BF998; BF998R

## THERMAL CHARACTERISTICS

SYMBOL	PARAMETER	CONDITIONS	VALUE	UNIT
$R_{th\ j-a}$	thermal resistance from junction to ambient in free air; BF998	note 1	460	K/W
		note 2	500	K/W
$R_{th\ j-a}$	thermal resistance from junction to ambient in free air; BF998R	note 1	500	K/W

## Notes

1. Device mounted on a ceramic substrate, 8 mm × 10 mm × 0.7 mm.
2. Device mounted on a printed-circuit board.

## STATIC CHARACTERISTICS

$T_j = 25\text{ °C}$ ; unless otherwise specified.

SYMBOL	PARAMETER	CONDITIONS	MIN.	MAX.	UNIT
$\pm V_{(BR)G1-SS}$	gate 1-source breakdown voltage	$V_{G2-S} = V_{DS} = 0$ ; $I_{G1-SS} = \pm 10\text{ mA}$	6	20	V
$\pm V_{(BR)G2-SS}$	gate 2-source breakdown voltage	$V_{G1-S} = V_{DS} = 0$ ; $I_{G2-SS} = \pm 10\text{ mA}$	6	20	V
$-V_{(P)G1-S}$	gate 1-source cut-off voltage	$V_{G2-S} = 4\text{ V}$ ; $V_{DS} = 8\text{ V}$ ; $I_D = 20\text{ }\mu\text{A}$	–	2.0	V
$-V_{(P)G2-S}$	gate 2-source cut-off voltage	$V_{G1-S} = 0$ ; $V_{DS} = 8\text{ V}$ ; $I_D = 20\text{ }\mu\text{A}$	–	1.5	V
$I_{DSS}$	drain-source current	$V_{G2-S} = 4\text{ V}$ ; $V_{DS} = 8\text{ V}$ ; $V_{G1-S} = 0$ ; note 1	2	18	mA
$\pm I_{G1-SS}$	gate 1 cut-off current	$V_{G2-S} = V_{DS} = 0$ ; $V_{G1-S} = \pm 5\text{ V}$	–	50	nA
$\pm I_{G2-SS}$	gate 2 cut-off current	$V_{G1-S} = V_{DS} = 0$ ; $V_{G2-S} = \pm 5\text{ V}$	–	50	nA

## Note

1. Measured under pulse condition.

## DYNAMIC CHARACTERISTICS

Common source;  $T_{amb} = 25\text{ °C}$ ;  $V_{DS} = 8\text{ V}$ ;  $V_{G2-S} = 4\text{ V}$ ;  $I_D = 10\text{ mA}$ .

SYMBOL	PARAMETER	CONDITIONS	MIN.	TYP.	MAX.	UNIT
$ y_{fs} $	forward transfer admittance	$f = 1\text{ kHz}$	21	24	–	mS
$C_{ig1-s}$	input capacitance at gate 1	$f = 1\text{ MHz}$	–	2.1	2.5	pF
$C_{ig2-s}$	input capacitance at gate 2	$f = 1\text{ MHz}$	–	1.2	–	pF
$C_{os}$	output capacitance	$f = 1\text{ MHz}$	–	1.05	–	pF
$C_{rs}$	reverse transfer capacitance	$f = 1\text{ MHz}$	–	25	–	fF
F	noise figure	$f = 200\text{ MHz}$ ; $G_S = 2\text{ mS}$ ; $B_S = B_{Sopt}$	–	0.6	–	dB
		$f = 800\text{ MHz}$ ; $G_S = 3.3\text{ mS}$ ; $B_S = B_{Sopt}$	–	1.0	–	dB

Silicon N-channel dual-gate MOS-FETs

BF998; BF998R

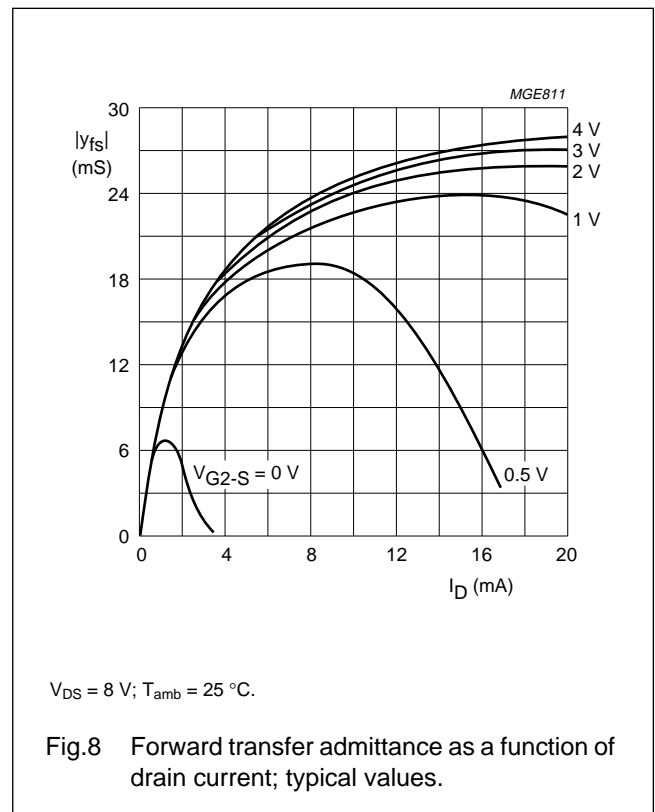
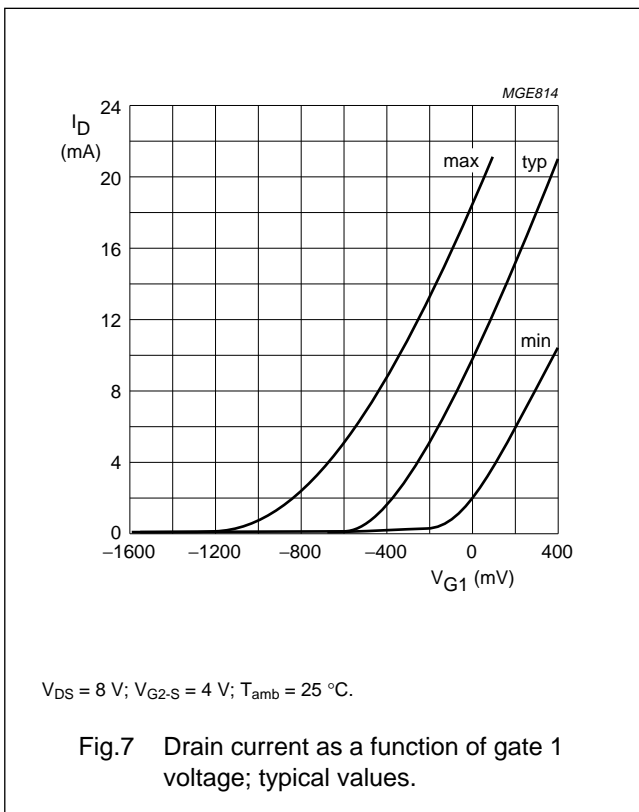
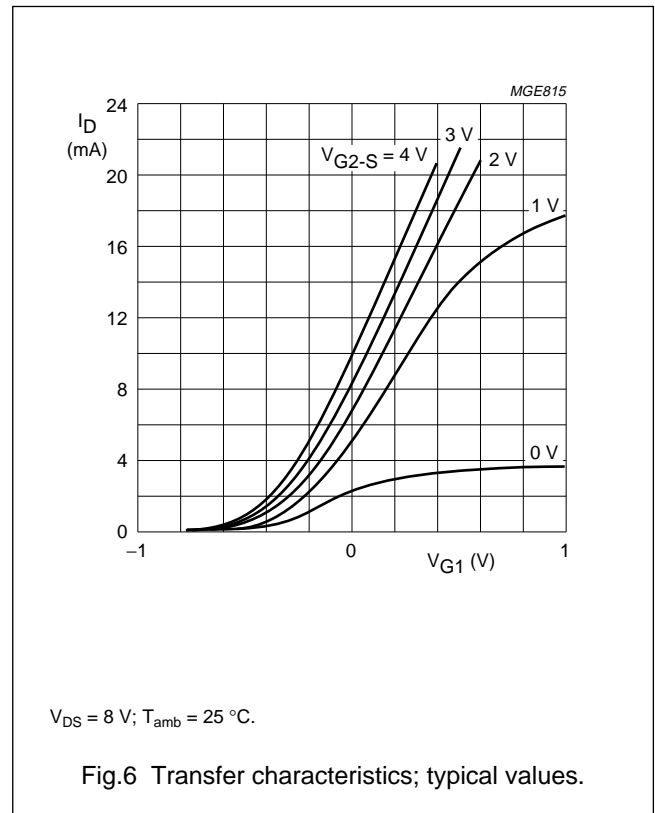
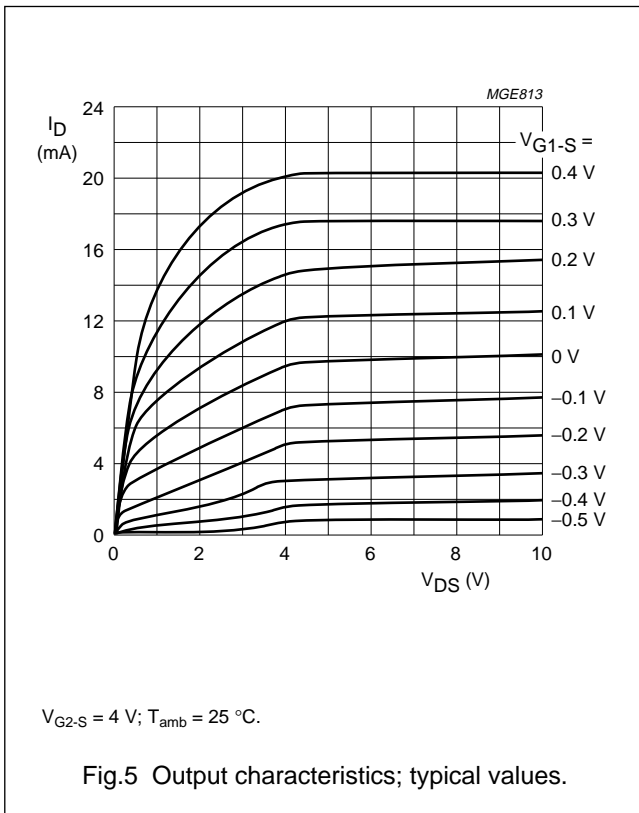

Silicon N-channel dual-gate MOS-FETs

BF998; BF998R

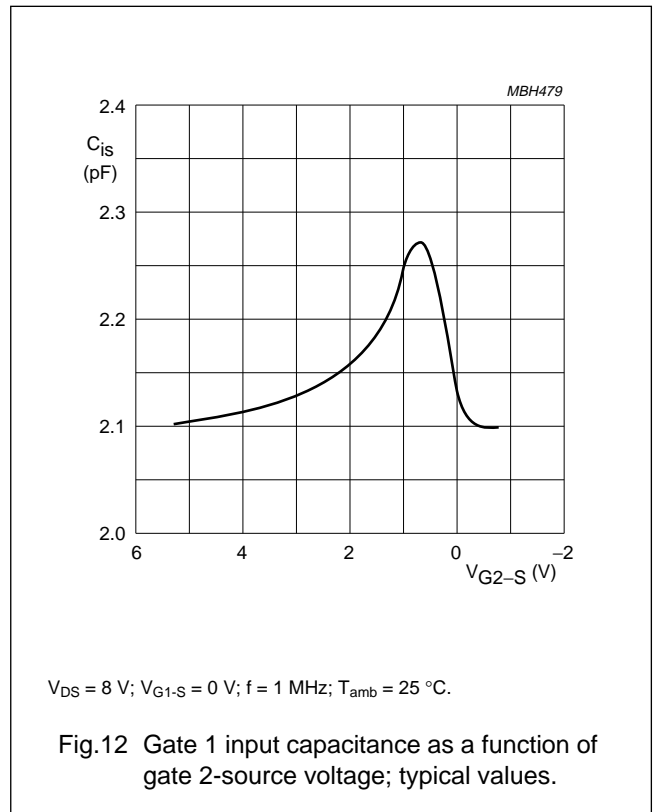
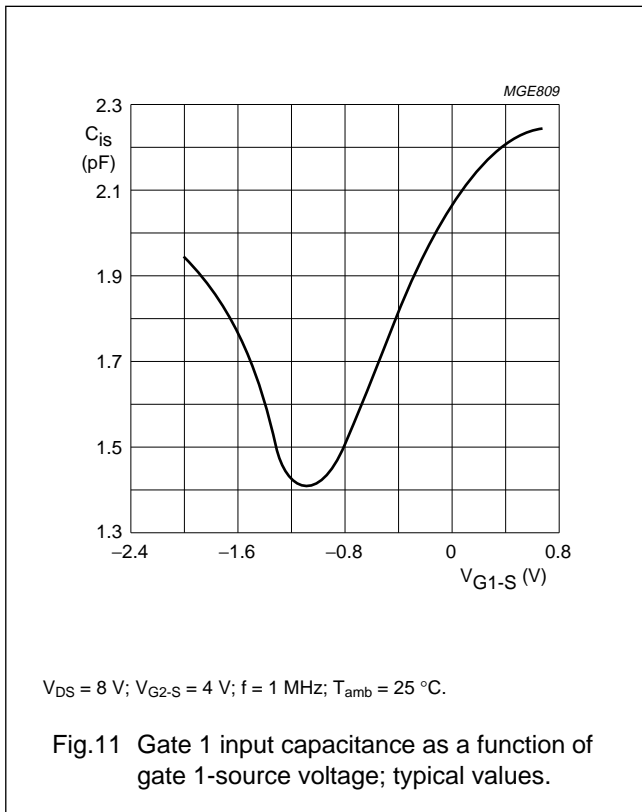
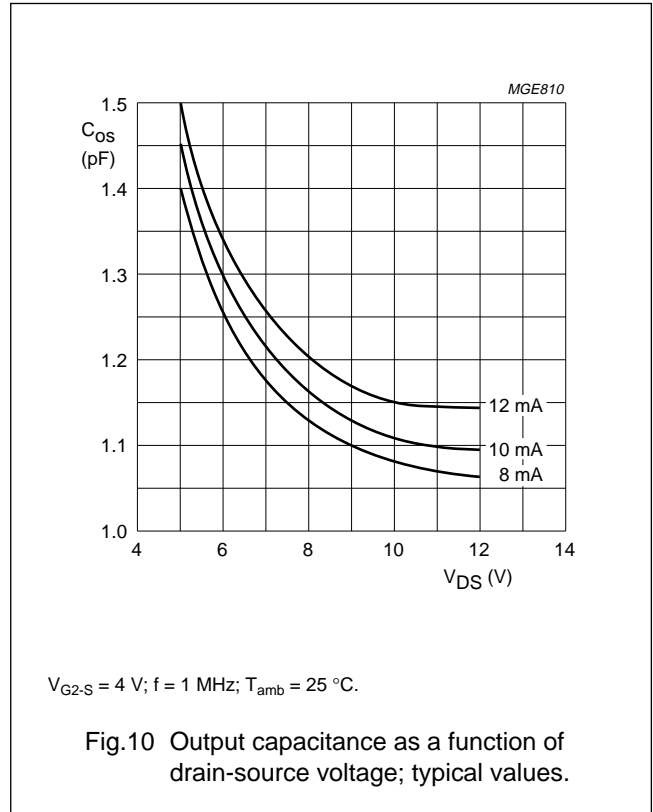
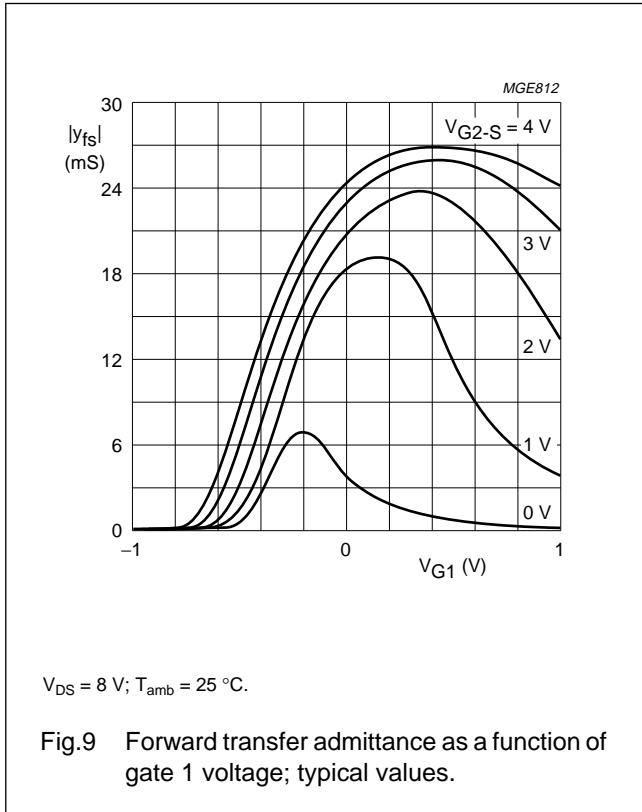

Silicon N-channel dual-gate MOS-FETs

BF998; BF998R

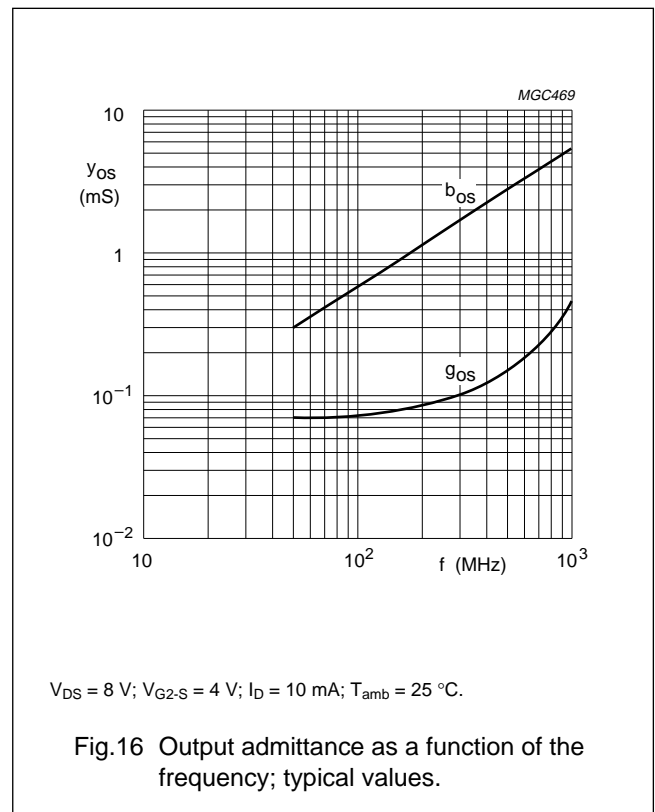
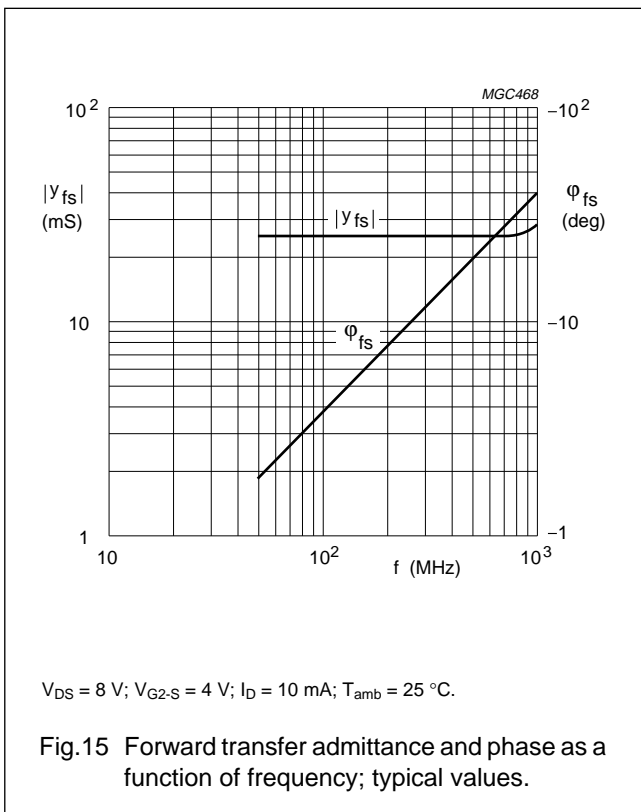
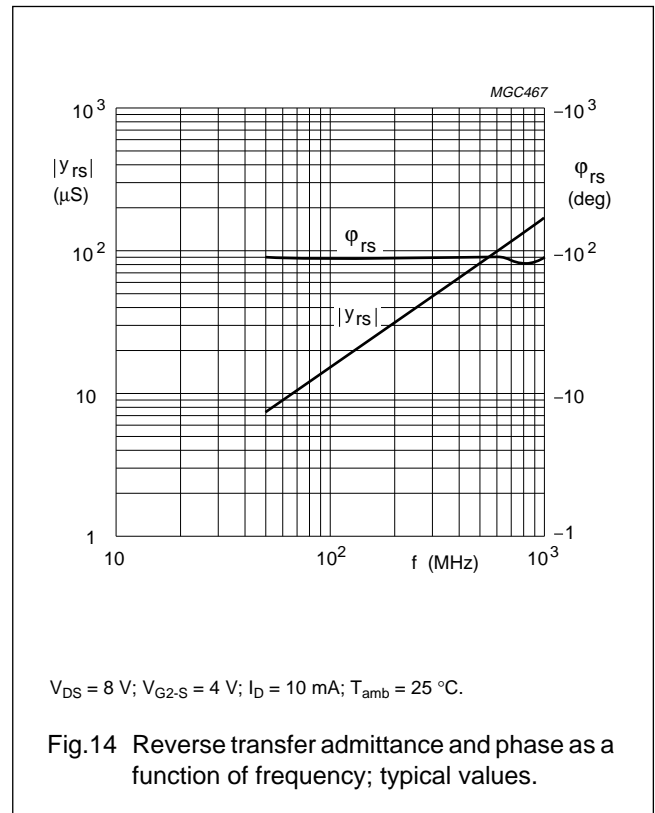
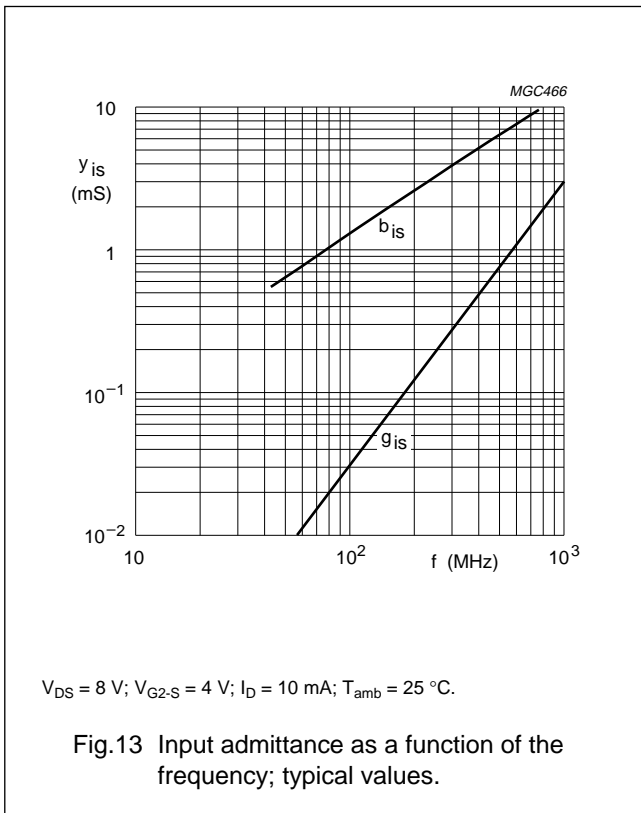

Silicon N-channel dual-gate MOS-FETs

BF998; BF998R

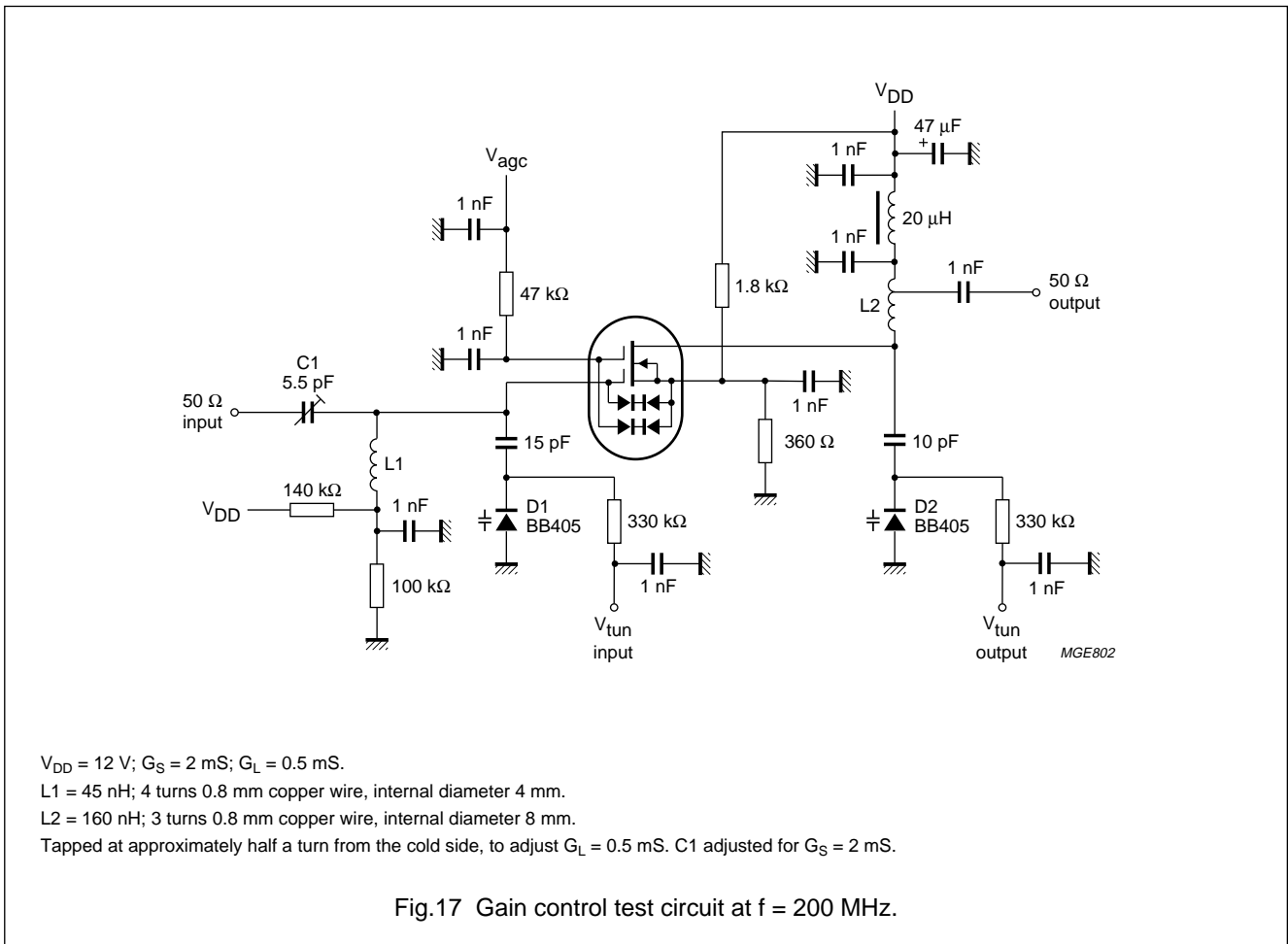

Fig.17 Gain control test circuit at  $f = 200\text{ MHz}$ .





Silicon N-channel dual-gate MOS-FETs

BF998; BF998R

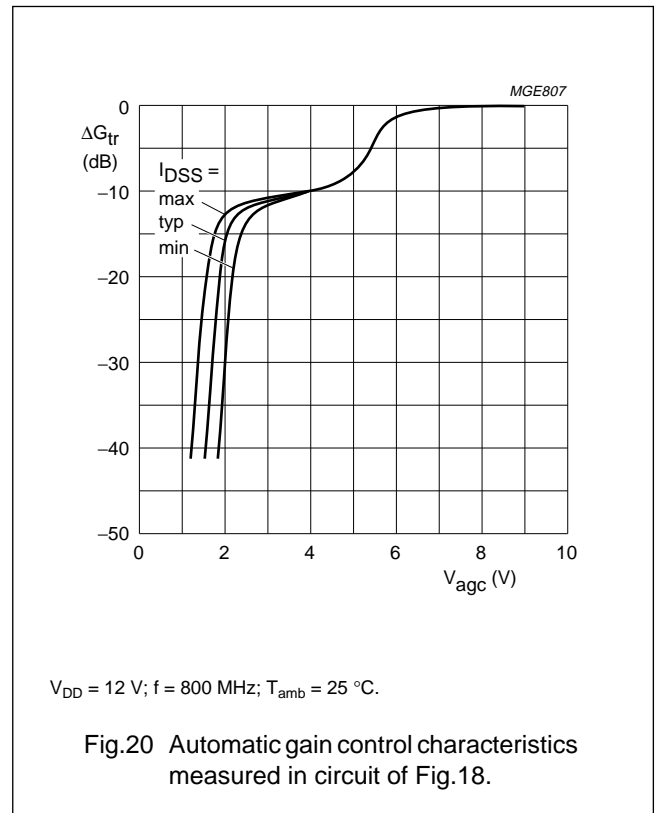
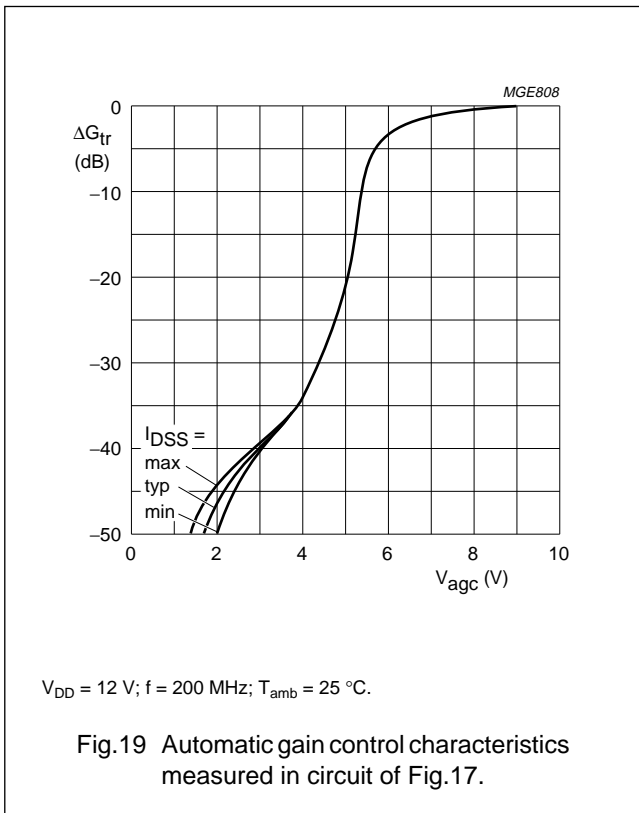

Silicon N-channel dual-gate MOS-FETs

BF998; BF998R

PACKAGE OUTLINES

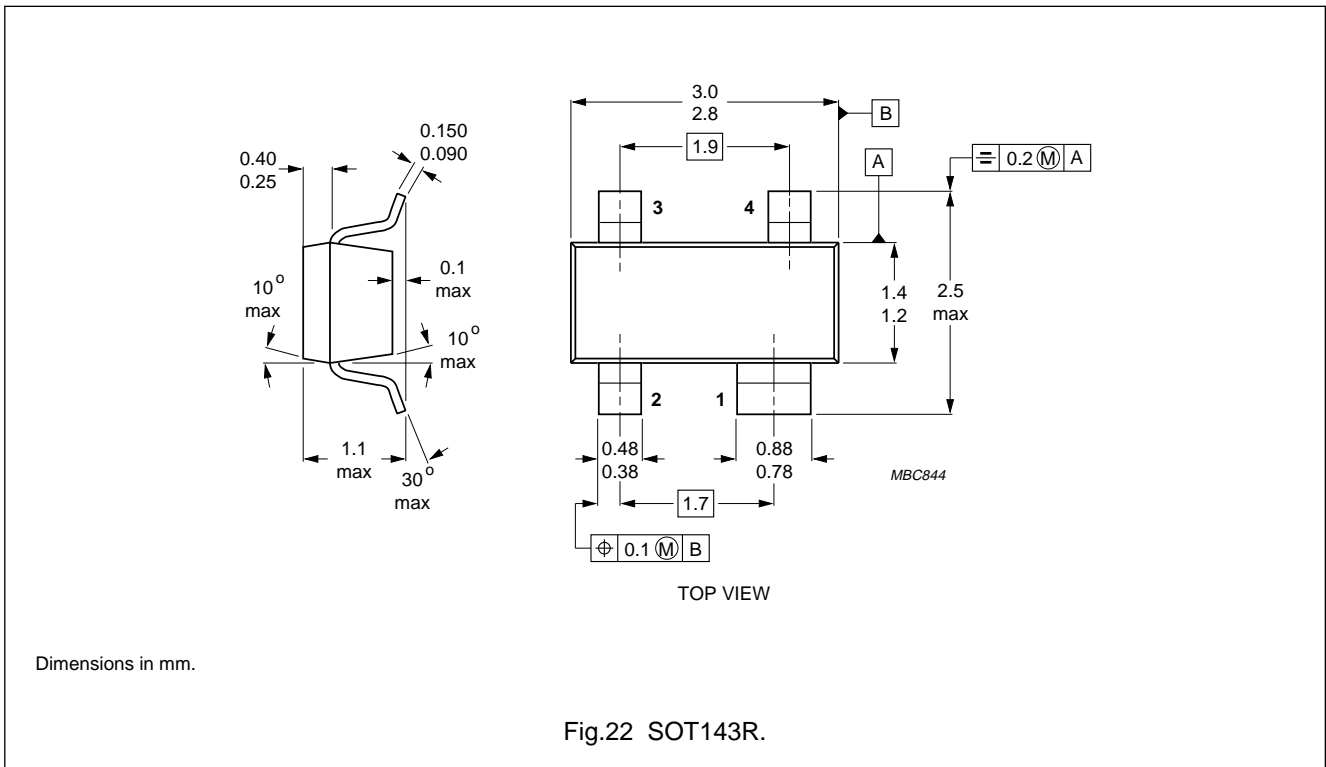
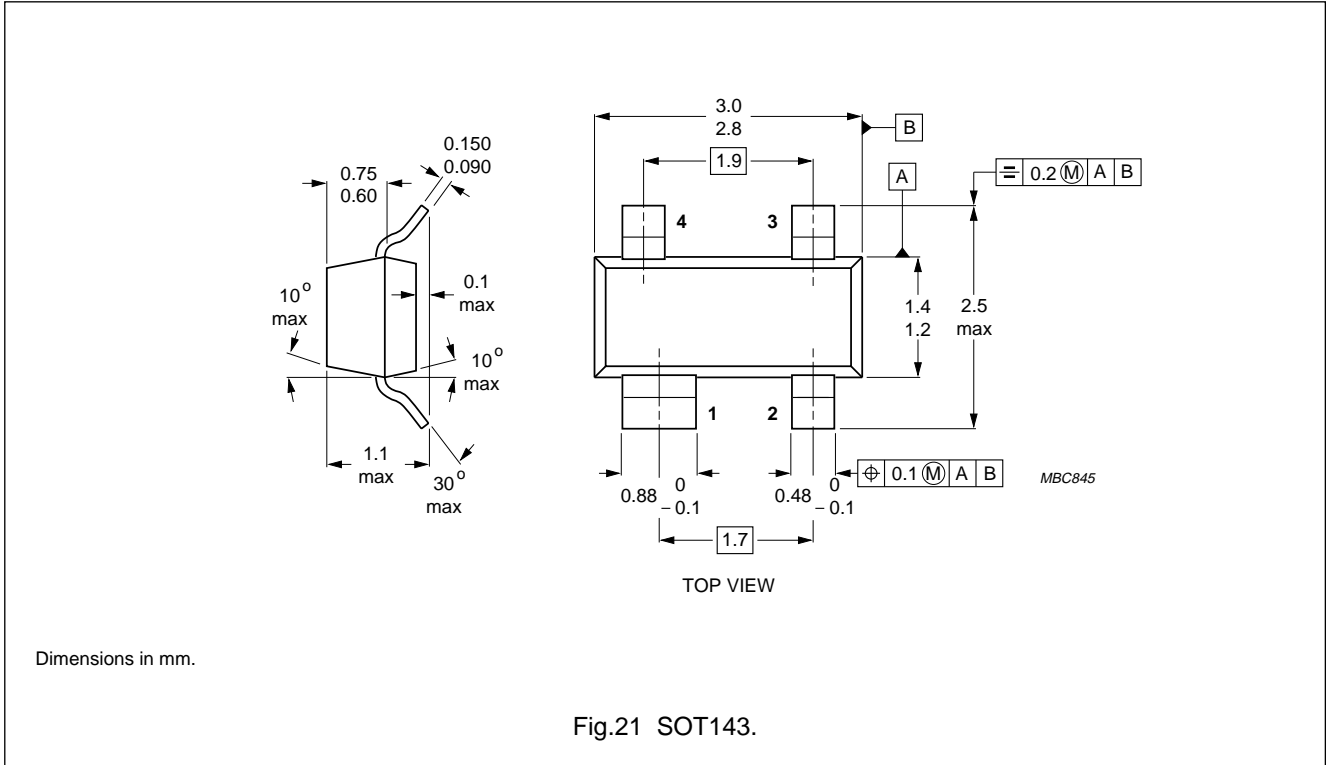

## Silicon N-channel dual-gate MOS-FETs

BF998; BF998R

**DEFINITIONS**

<b>Data Sheet Status</b>	
Objective specification	This data sheet contains target or goal specifications for product development.
Preliminary specification	This data sheet contains preliminary data; supplementary data may be published later.
Product specification	This data sheet contains final product specifications.
<b>Limiting values</b>	
Limiting values given are in accordance with the Absolute Maximum Rating System (IEC 134). Stress above one or more of the limiting values may cause permanent damage to the device. These are stress ratings only and operation of the device at these or at any other conditions above those given in the Characteristics sections of the specification is not implied. Exposure to limiting values for extended periods may affect device reliability.	
<b>Application information</b>	
Where application information is given, it is advisory and does not form part of the specification.	

**LIFE SUPPORT APPLICATIONS**

These products are not designed for use in life support appliances, devices, or systems where malfunction of these products can reasonably be expected to result in personal injury. Philips customers using or selling these products for use in such applications do so at their own risk and agree to fully indemnify Philips for any damages resulting from such improper use or sale.