

# Switching (30V, 13A)

## RSS130N03

### ●Features

- 1) Low on-resistance.
- 2) Built-in G-S Protection Diode.
- 3) Small and Surface Mount Package (SOP8).

### ●Application

Power switching, DC/DC converter.

### ●Structure

Silicon N-channel  
MOS FET

### ●External dimensions (Units : mm)

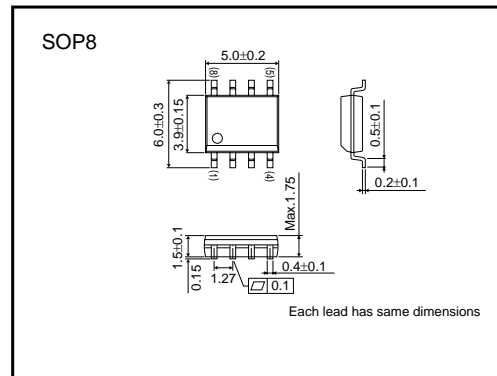

### ●Absolute maximum ratings (Ta = 25°C)

Parameter	Symbol	Limits	Unit	
Drain-Source Voltage	$V_{DS}$	30	V	
Gate-Source Voltage	$V_{GS}$	20	V	
Drain Current	Continuous	$I_D$	±13	A
	Pulsed	$I_{DP}^*$	±52	A
Source Current (Body Diode)	Continuous	$I_S$	1.6	A
	Pulsed	$I_{SP}^*$	6.4	A
Total Power Dissipation (TC=25°C)	$P_D$	2	W	
Channel Temperature	$T_{ch}$	150	°C	
Storage Temperature	$T_{stg}$	-55 to +150	°C	

\* $P_w \leq 10 \mu s$ , Duty cycle  $\leq 1\%$

### ●Equivalent circuit

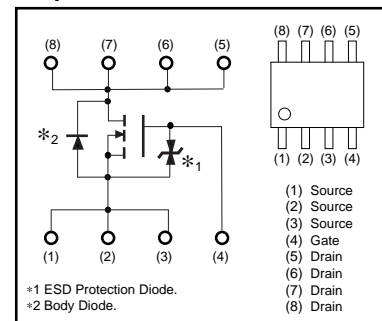

\*1 ESD Protection Diode.  
\*2 Body Diode.  
\* A protection diode is included between the gate and the source terminals to protect the diode against static electricity when the product is in use. Use a protection circuit when the fixed voltage are exceeded.

### ●Thermal resistance (Ta = 25°C)

Parameter	Symbol	Limits	Unit
Channel to Ambient	$R_{th(ch-A)}$	62.5	°C / W

## Transistors

## ●Electrical characteristics (Ta = 25°C)

Parameter	Symbol	Min.	Typ.	Max.	Unit	Test Conditions
Gate-Source Leakage	I <sub>GSS</sub>	–	–	10	μA	V <sub>GS</sub> =20V, V <sub>DS</sub> =0V
Drain-Source Breakdown Voltage	V <sub>(BR)DSS</sub>	30	–	–	V	I <sub>D</sub> =1mA, V <sub>GS</sub> =0V
Zero Gate Voltage Drain Current	I <sub>DSS</sub>	–	–	1	μA	V <sub>DS</sub> =30V, V <sub>GS</sub> =0V
Gate Threshold Voltage	V <sub>GS(th)</sub>	1.0	–	2.5	V	V <sub>DS</sub> =10V, I <sub>D</sub> =1mA
Static Drain-Source On-State Resistance	R <sub>DS(on)</sub> *	–	5.9	8.1	mΩ	I <sub>D</sub> =13A, V <sub>GS</sub> =10V
		–	7.4	10.3		I <sub>D</sub> =13A, V <sub>GS</sub> =4.5V
		–	7.9	11.0		I <sub>D</sub> =13A, V <sub>GS</sub> =4V
Forward Transfer Admittance	Y <sub>fs</sub>  *	11	–	–	S	I <sub>D</sub> =13A, V <sub>DS</sub> =10V
Input Capacitance	C <sub>iss</sub>	–	2000	–	pF	V <sub>DS</sub> =10V
Output Capacitance	C <sub>oss</sub>	–	605	–	pF	V <sub>GS</sub> =0V
Reverse Transfer Capacitance	C <sub>rss</sub>	–	320	–	pF	f=1MHz
Turn-On Delay Time	t <sub>d(on)</sub> *	–	13	–	ns	I <sub>D</sub> =6.5A, V <sub>DD</sub> =15V
Rise Time	t <sub>r</sub> *	–	30	–	ns	V <sub>GS</sub> =10V
Turn-Off Delay Time	t <sub>d(off)</sub> *	–	88	–	ns	R <sub>L</sub> =2.31Ω
Fall Time	t <sub>f</sub> *	–	55	–	ns	R <sub>GS</sub> =10Ω
Total Gate Charge	Q <sub>g</sub> *	–	25	35	nC	V <sub>DD</sub> =15V
Gate-Source Charge	Q <sub>gs</sub> *	–	4.7	–	nC	V <sub>GS</sub> =5V
Gate-Drain Charge	Q <sub>gd</sub> *	–	9.4	–	nC	I <sub>D</sub> =13A

\*Pulsed

## ●Body diode characteristics (Source-Drain Characteristics) (Ta = 25°C)

Parameter	Symbol	Min.	Typ.	Max.	Unit	Test Conditions
Forward Voltage	V <sub>SD</sub> *	–	–	1.2	V	I <sub>S</sub> =6.4A, V <sub>GS</sub> =0V

\*Pulsed

Transistors

●Electrical characteristic curves

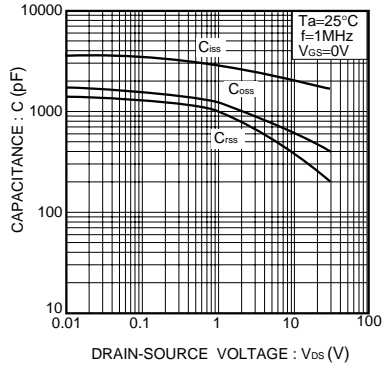

Fig.1 Typical Capacitance vs. Drain-Source Voltage

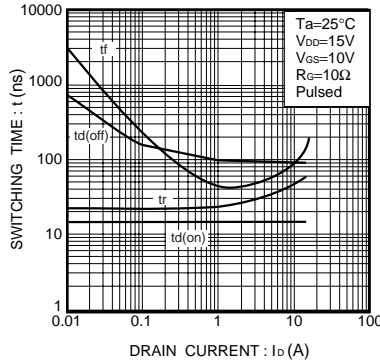

Fig.2 Switching Characteristics

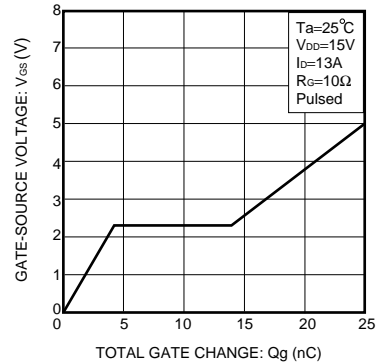

Fig.3 Dynamic Input Characteristics

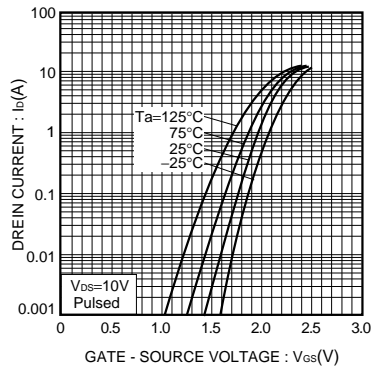

Fig.4 Typical Transfer Characteristics

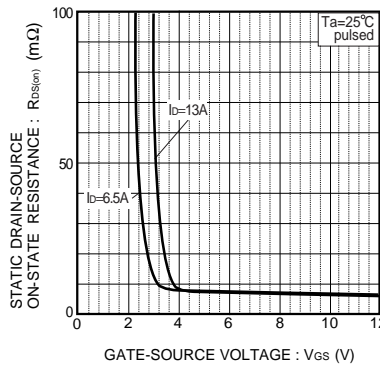

Fig.5 Static Drain-Source On-State Resistance vs. Gate-Source Voltage

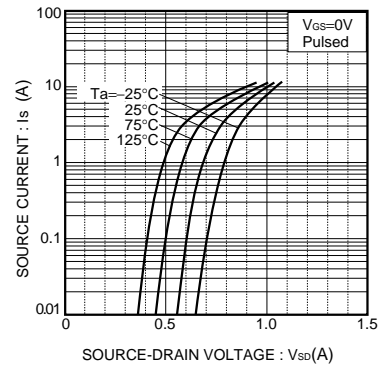

Fig.6 Source-Current vs. Source-Drain Voltage

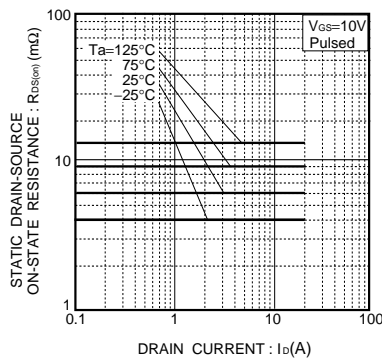

Fig.7 Static Drain-Source On-State Resistance vs. Drain Current (1)

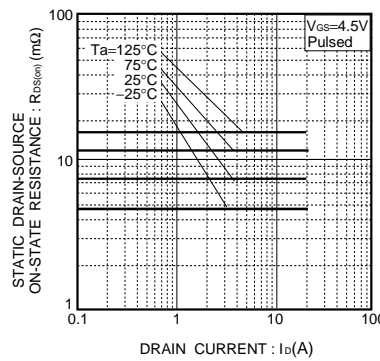

Fig.7 Static Drain-Source On-State Resistance vs. Drain Current (2)

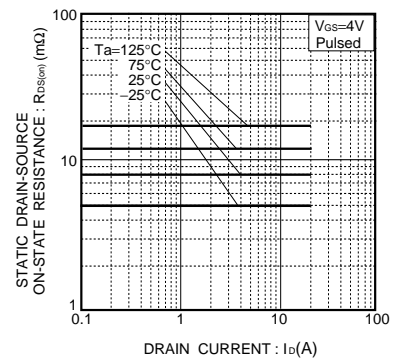

Fig.7 Static Drain-Source On-State Resistance vs. Drain Current (3)