



## ***APPLICATION NOTE II***

***Detection and ranging of moving and stationary objects by using the FMCW radar principle***

## **Table of contents**

1. Introduction and theoretical considerations
  - 1.1 Functional requirements
  - 1.2 The FMCW radar principle
    - 1.2.1 The FMCW radar for range measurement of a stationary object
    - 1.2.2 Simultaneous evaluation of range and velocity of a scattering object
2. Measured parameters, processing strategy
  - 2.1 Frequency measurement
  - 2.2 I/Q applications
3. Applications
  - 3.1 Peripheral circuitry and operation of FMCW radars
  - 3.2 First installation, real receive signals

***Copying/publishing this note or parts of it requires  
the endorsement of the author.***

# Detection and ranging of moving and stationary objects by using the FMCW radar principle

## - Application note 02 -

### 1. Introduction and theoretical considerations

#### 1.1 Functional requirements

In commercial applications the FMCW radar principle becomes more and more interesting, since transceiver modules are available at low cost. In many applications the sensor shall provide data about stationary objects or in case of moving objects additional information like speed and range.

The FMCW radar principle offers this possibility and is providing information

in case of **moving objects** about

- instantaneous velocity and direction of motion (like the usual Doppler radar)
- instantaneous distance of the object from the sensor
- the angle of arrival of the object with a certain receiver arrangement

in case of **stationary objects** about

- the distance from the sensor
- the angle with a certain receiver arrangement.

With proper processing of the low-frequency receive signals the FMCW is multitarget-capable, that means it can distinguish between different objects regarding velocity and range and regarding the instantaneous coordinates in space.

Generally more effort is required to process the receive signals of a FMCW application than signals from a Doppler device.

This note shall be a primer to start work on a FMCW radar solution.

#### 1.2 The FMCW radar principle

In general the basic difference of a FMCW-capable radar to a simple so-called Doppler radar is the usage of a time-variable transmit frequency versus a fixed frequency. The following considerations apply independantly from the transmit frequency used.

It should be noted that in a later chapter the existence of allocated frequency bands will be mentioned, since it must be assured that such radars do not violate existing local and worldwide regulations.

While the so-called Doppler radar makes use of the well-known Doppler effect, which only occurs with moving objects, the FMCW radar must use delay effects when electromagnetic waves are travelling and being reflected and scattered by individual objects. Principally you could compare the phase difference of the receive signal to the transmit signal. However due to the short wavelength of microwaves the phase information becomes ambiguous in distances greater than one wavelength (for instance every 12mm for a transmit frequency of 24 GHz), which does not allow a reliable reference to a certain distance.

The simultaneous evaluation of more than one parameter of an object as for instance velocity and range ends up in the mathematical task to solve an equation system with an adequate number of unknowns. Therefore during a measurement cycle it must be possible to generate the same number of equations as unknowns by smartly selecting time functions (in our example 2 equations with 2 unknowns), so this system becomes plainly solvable

We want to point at the basic possibilities and principals of FMCW technique by selecting the simplest time functions possible for the transmit frequency. The simplest curve apart from a constant transmit frequency is of course the linear curve with steadily increasing or decreasing frequency over time. These curves are selected, while others are possible, but generate more complex receive signals, which require a more complex processing.

### 1.2.1 The FMCW radar for range measurement of a stationary object

If it is just required to measure one parameter – distance – of a stationary object from the sensor, it is sufficient to use the linearly increasing or decreasing ramp slope as time-dependant function of the transmit frequency called „sawtooth function“ and to periodically repeat this ramp, in order to render possible averaging.

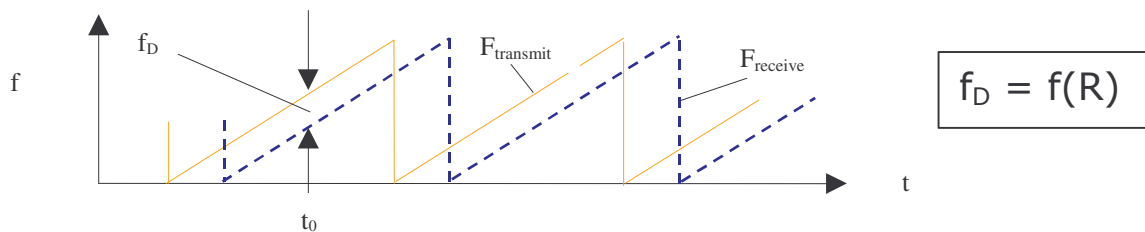

Fig 1: time-dependant curve of the transmit and receive signals of a FMCW radar with sawtooth modulation

The explanation is simply given by fig. 1. The (yellow) transmitter frequency curve differs from the (blue) receive signal curve just by a certain time delay.

Looking at the instantaneous receive signal curve at a certain point of time  $t_0$ , it is lower in frequency compared with the instantaneous transmit frequency (in case of an increasing ramp), since the transmitter has meanwhile moved up in frequency. If mixing the transmit and receive signals at the mixer, a signal with constant differential frequency is generated, which includes the desired range information. This frequency is the higher, the further away the reflecting object is located.

The following relation exists:

$$R = \frac{c_0}{2} \cdot T \cdot \frac{f_D}{\Delta f} \quad (1)$$

It means:

- $f_D$  differential frequency
- $\Delta f$  frequency variation of transmitter oscillator
- $T$  sawtooth repetition frequency
- $R$  distance of a reflecting object
- $c_0$  speed of light

This equation shall be discussed in order to evaluate the limitations of distance measurement with radar.

It is obvious, that a large frequency variation  $\Delta f$  is required to measure short distances, because  $\Delta f$  is part of the denominator.

Processing and evaluation of the differential frequency makes sense, until the sweep frequency equals the differential frequency or in other words, if the sweep generate at least one full period of the differential frequency.

This leads to the smallest evaluable range as follows:

with  $T = \frac{1}{f_D}$  from (1): 
$$R_{\min} = \frac{c_0}{2 \cdot \Delta f} \quad (2)$$

Looking at the ISM band at 24 GHz with an allocated bandwidth of 250 MHz, the minimum measurable distance therefore is 0.75m.

### 1.2.2 Simultaneous evaluation of range and velocity of a scattering object

Looking at a moving object, which speed and distance shall be determined, we are faced with the superposition of two effects:

the delay effect as described in 1.2.1, which leads to a time delay of the receive signal pattern parallel to the x - (time) axis

$$f_{\text{delay}} = \frac{2 \cdot R \cdot \Delta f}{c_0 \cdot T} \quad (3), \text{ derived from (1)}$$

the so-called Doppler effect, which leads to a shift of the receive frequency parallel to the y - (frequency) axis, caused by the object movement

Here is the formula for that: 
$$f_{\text{Dopp}} = 2f_0 \cdot \frac{v}{c_0} \cdot \cos \alpha \quad (4)$$

It means:

- $f_{\text{dopp}}$  frequency shift by Doppler effect
- $c_0$  speed of light
- $v$  velocity of the moving object
- $\alpha$  angle of the direction of the object motion with the direct connecting straight line between sensor and object

To simplify the equation we set the angle  $\alpha$  to zero (object is moving straight towards or away from the sensor), while the value of this term becomes one.

$$f_{\text{Dopp}} = 2f_0 \cdot \frac{v}{c_0} \quad (5)$$

Furthermore we have to take into account that we require two equations since we want to calculate two unknown parameters. Instead of using a sawtooth function as in 1.2.1, which only generates one equation by its rising slope, we shall require a triangular function, since the rising and the dropping slope generate one equation each. Both parameters to be measured, R range and v velocity, can be calculated by solving two equations with two unknowns.

The following figure explains the conditions of a triangular waveform-modulated microwave signal in the transmit and receive case after reflexion by a scattering object.

We calculate the differential receive signals for the rising (up) and the falling (down) part of the triangular modulation signal:

$$(A) \quad f_{Diff\_up} = |f_{Dopp} - f_{delay}|$$

$$(B) \quad f_{Diff\_down} = f_{Dopp} + f_{delay}$$

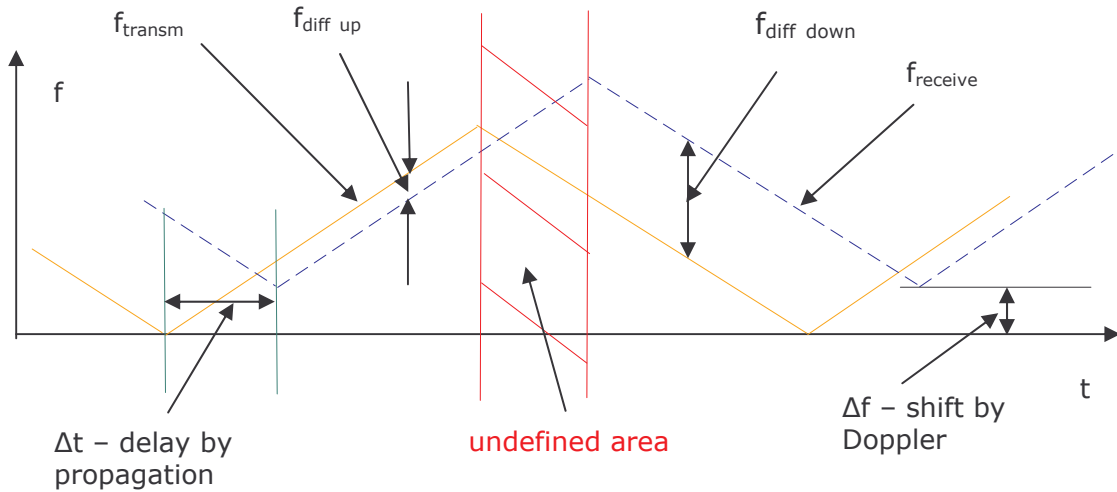

Fig 2: time-dependant patterns of transmit and receive signal frequencies of a triangular-modulated FMCW radar

We add (A) and (B) and get:

$$f_{Diff\_up} + f_{Diff\_down} = 2 \cdot f_{Dopp}$$

or with (5)

$$f_{Diff\_up} + f_{Diff\_down} = 2 \cdot 2f_0 \cdot \frac{v}{c_0}$$

We calculate v as:

$$v = \frac{c_0 \cdot (f_{Diff\_up} + f_{Diff\_down})}{4 \cdot f_0} \quad (6)$$

Furthermore we subtract (A) from (B) and get:

$$|f_{Diff\_up} - f_{Diff\_down}| = 2 \cdot f_{delay}$$

or with (3)

$$|f_{Diff\_up} - f_{Diff\_down}| = \frac{2 \cdot 2 \cdot R \cdot \Delta f}{(c_0 \cdot T)}$$

We calculate R as:

$$R = \frac{(|f_{Diff\_up} - f_{Diff\_down}| \cdot c_0 \cdot T)}{(4 \cdot \Delta f)} \quad (7)$$

All parameters in (6) and (7) are either of known values like  $f_0$ ,  $\Delta f$ ,  $c_0$ , and  $T$  or they got to be determined by frequency measurement ( $f_{diff\_up}$  und  $f_{diff\_down}$ ).

## 2. Measured parameters, processing strategy

### 2.1 Frequency measurement

As stated before, some parameters are known by the operational parameters of the radar itself. However the frequencies  $f_{\text{diff up}}$  und  $f_{\text{diff down}}$  have to be measured during operation of the radar. As shown in fig. 2 there are areas of intersections, where no monotonous values for  $f_{\text{diff up}}$  und  $f_{\text{diff down}}$  can be found. Therefore these sections cannot be used for real frequency measurements.

In those areas of the rising and the falling slopes, where constant frequency values are achievable, these individual frequencies can be evaluated during the time window available.

The complexity of this evaluation of the frequency is very much depending on the application. Basically it is possible to measure those differential frequencies by smartly cancelling the not-permitted slots and counting zero-crossings or using PLL, while those frequencies are usually located in the few kHz range. The receive signal can be converted by A/D conversion and sampled for zero-crossings as an example. This will however only work as long as one single reflecting object only is involved. As soon as more than one object exist within the antenna pattern, the received differential frequencies of each target superpose each other, ending up in a complex and distorted bulk of waveforms, which will finally result in misleading frequency readings for instance if counting of zero-crossings is used.

In the case of multiple targets a digital signal analysis by FFT (fast Fourier transform) is definitely required. It converts the „overloaded“ time signals into a frequency spectrum, where individual objects pop up as individual and clearly identifiable frequency peaks. Further involvement in processing strategies would exceed the objective of this paper. One hint may be helpful, that in some simple applications the usage of a so-called „audio-board“ may lead to an acceptable result.

### 2.2 I/Q applications

Generally all what has been explained so far for one receive signal channel, can also be processed with sensors with so-called I/Q- or dual or stereo approach. The complexity of processing will slightly increase, however the advantage is to get rid of effects in reality – the cancellation of signals by interference such as standing waves, which is leading to periodic signals „nulls“. These effects are no defects or malfunctions of your radar device, they are just based on the physics and nature of propagation of microwaves.

I/Q arrangements extract the receive signals from two receiver mixers being spaced by a quarter wavelength and enable the user to determine the signals as complex vectors within the complex plane. It means that if the I-channel may show a very low or no signal, the Q-channel will actually show a maximum and vice versa.



### 3. Applications

#### 3.1 Peripheral circuitry and operation of FMCW radars

Compared with a simple Doppler radar a FMCW-capable transceiver includes another input port – the frequency tuning port called “sweep” or “chirp”. Depending on manufacturer and device family, a tuning voltage between 0 and 8V will cause a change in transmit frequency. For instance the 24 GHz VCO transceiver family IVS24-2-4-2-162 or IVS24-2-8-4-148 of InnoSenT GmbH show a tuning slope of 40 to 50 MHz/V, which means that with a 5V voltage swing at the frequency tuning input the unit can easily be tuned over the whole ISM band. The maximum sweep/chirp frequency is determined by the internal

circuitry, while devices from InnoSenT allow modulation frequencies definitely up to and higher than 100 kHz.

The linearity of the frequency tuning curve is depending on the frequency tuning range used. When tuning over a relatively small tuning range like for instance just 10 MHz, the linearity can be extremely good, while the frequency tuning response over the full band of 250 MHz will of course show a certain curving and non-linearity. If this has to be linearised, a pre-distortion circuit is required to compensate the  $f(V)$  characteristics.

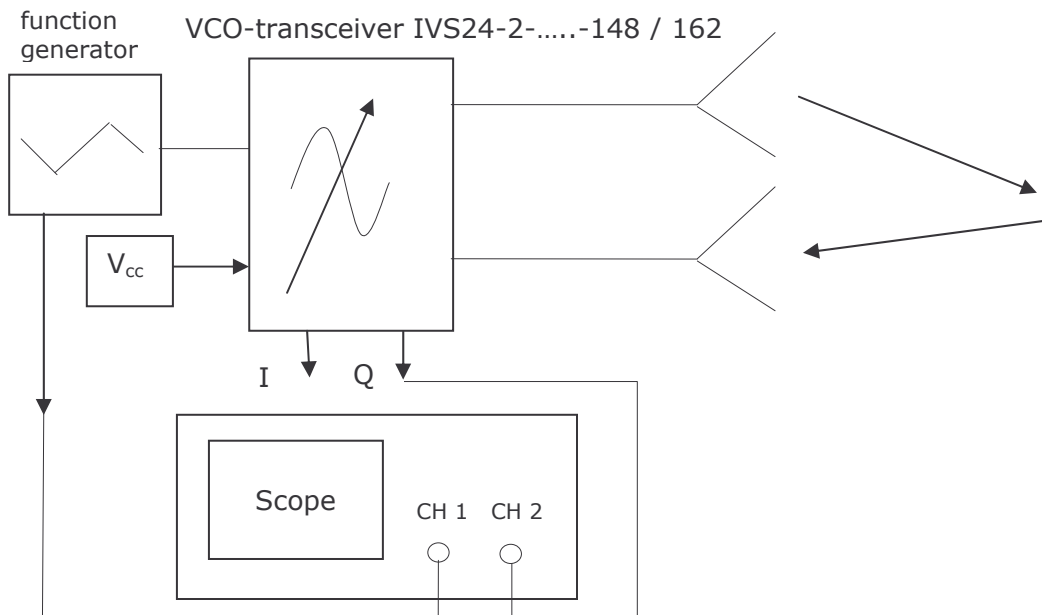

Fig. 4 test set-up for FMCW-VCO transceiver

How do typical characteristics and curves of a VCO transceiver look like?

Fig. 5 on next page shows typical characteristics of the frequency response as function of operating temperature at various tuning voltages.

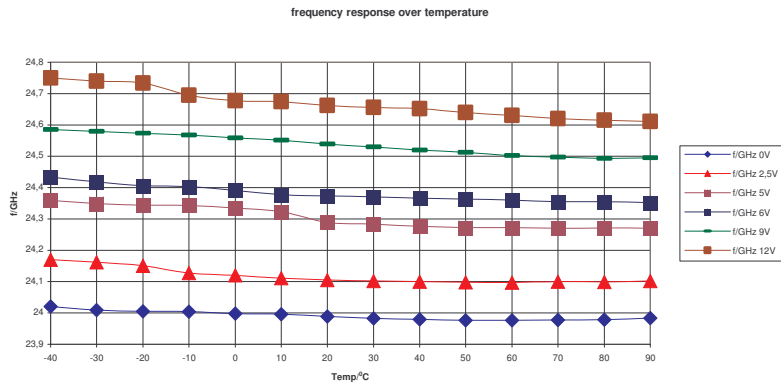

Fig. 5: frequency response of VCO transceivers like IVS24-2-...148/162 over temperature at various tuning voltages

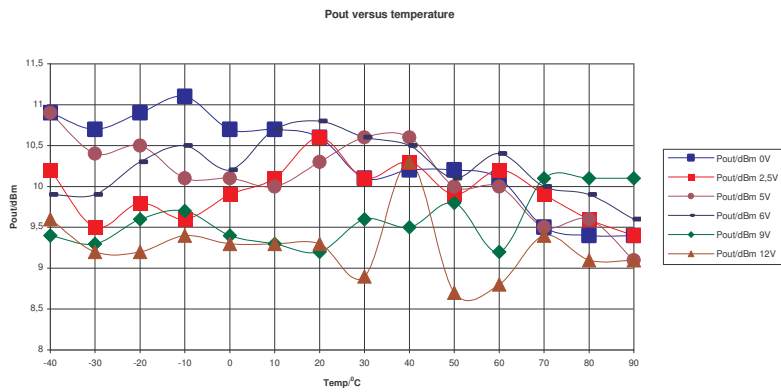

Fig 6: Output power of VCO transceivers like IVS24-2-....148/162 over temperature at various tuning voltages

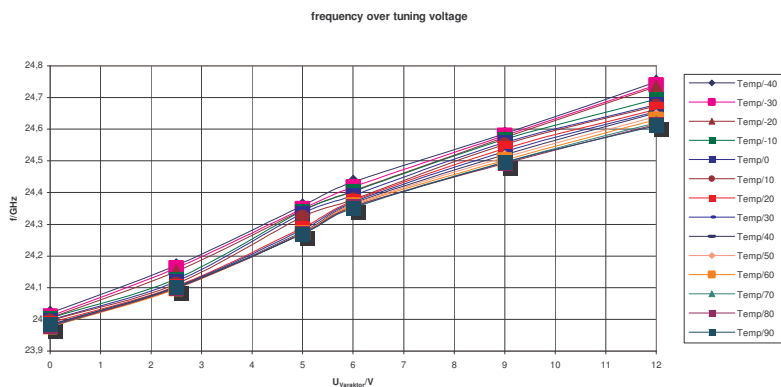

Fig 7: transmit frequency of VCO transceivers like IVS24-2-....148/162 over tuning voltage at various temperatures

Illustrations 5 thru 7 present the relation between transmit frequency, tuning voltage, operating temperature and output power of commercially available InnoSent VCO transceivers of the IVS24-2-....148 resp. 162 family.

### 3.2. First installation, real receive signals

Users, who install and operate a FMCW radar for the first time according to the manufacturer's recommendation without any further filtering actions, intend to believe that they have done something wrong or the transceiver device is not working properly. How does the very first scope shot of a FMCW radar output look like very often?

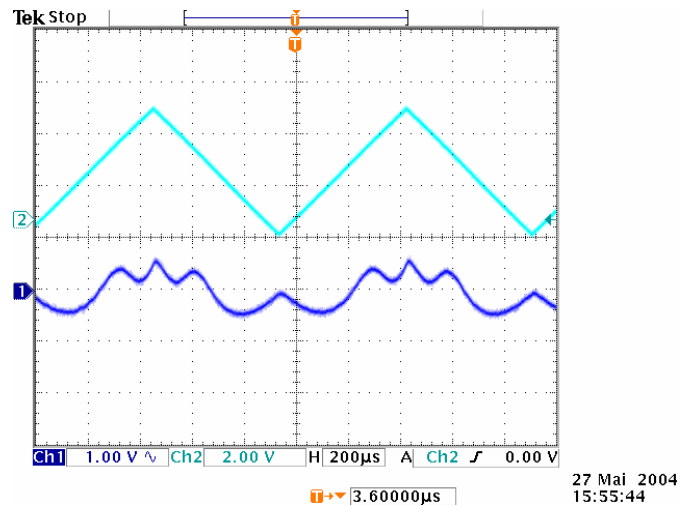

Fig. 8: Single-channel receiver output signal caused by a reflecting wall in abt. 2m distance from sensor, 240 MHz frequency variation, 1kHz sweep frequency, measured with InnoSenT VCO transceiver IVS24-2-8-4-148 LG, sweep signal curve bright blue, receiver output signal dark blue

The user will recognize, that the dominating low frequency signal seen on the scope has not much or actually nothing to do with the target location and stays firm, as long as parameters like sweep repetition frequency of the triangular modulation signal is not being changed. At that point it becomes obvious that this signals is the "crosstalk" of the sweep or chirp signal of the frequency modulation of the transmit part.

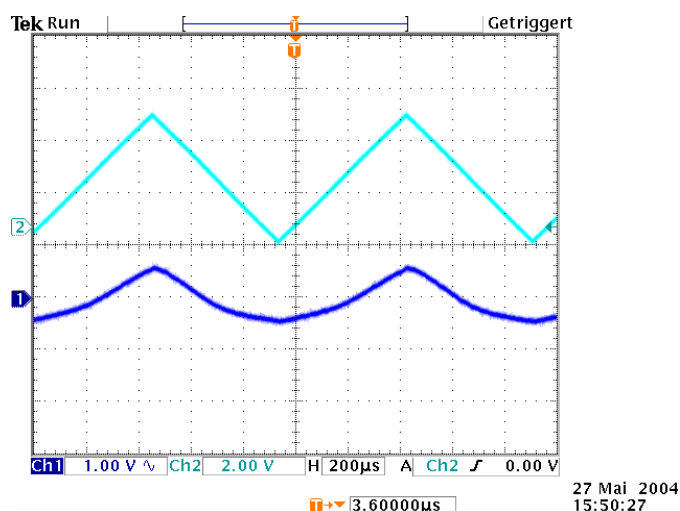

Fig 9: receiver output signal without any reflecting object

The fact is related to the realistic and non-ideally high isolation of the receiver mixer, it is depending on the device construction and can be compensated for certain limited ranges, but you can never get totally rid of it.

To minimize this effect filtering actions have to be taken as early as possible in the signal processing circuitry. A high first pre-amplification might be desirable (insensitive against ESD, best noise match), but it should not be higher than 20 to 30 dB of gain, in order to avoid to drive the following amplifier into saturation by the crosstalk of the sweep signal.

Now it becomes clear, why at short distances radar technology has got its limitations. In this case according to equation (2) the desired receive signals and the sweep signal are very close regarding frequency and cannot be separated by analog filtering anymore.

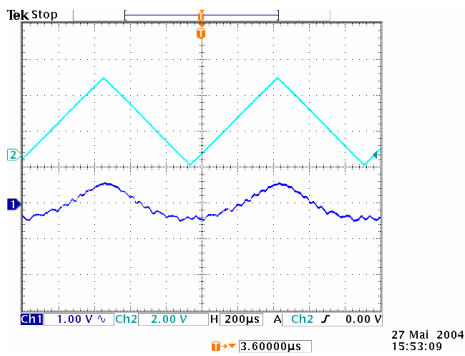

Fig. 10: wall in abt. 8m distance

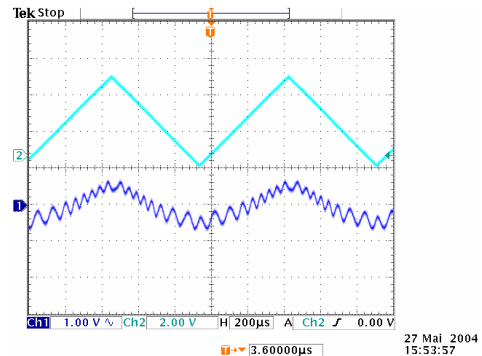

Fig. 11: wall in abt. 6m distance

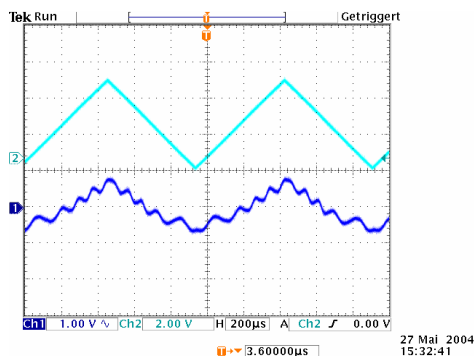

Fig. 12: wall in abt. 4m distance

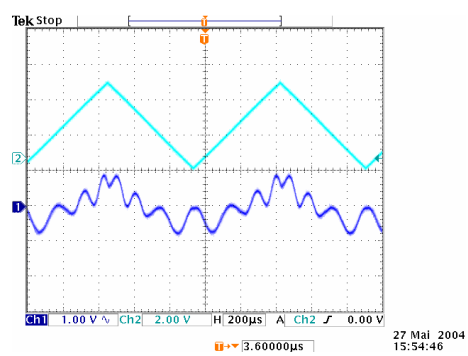

Fig. 13: wall in abt. 3 m distance

The patterns show typical signal waveforms using a wall as reflecting target in various distances. In each case the actual desired test signal is "modulated" on and in addition to the sweep signal. The real target signal can be filtered and amplified and therefore brought to a reasonable signal level for further processing. The scope shots demonstrate very well that the frequency of the target signal increases with target distance and carries the desired information.

It also becomes obvious that for distances longer than 3m (at 24 GHz) the sweep crosstalk does not represent a major problem anymore since it can easily be filtered by simple means from the target signal. However filtering is mandatory in any case!

The separation of target and sweep signal becomes easier when using digital signal analysis, since the existence and the position of the sweep signal peak is well predictable in the overall frequency spectrum of the output signal.