

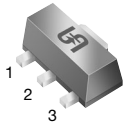

TS79L00

3-Terminal Negative Output Voltage Regulators

SOT-89



Pin: 1. Ground 2. Input 3. Output
(Heatsink surface connected to Pin 2.)

TO-92

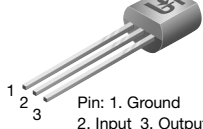

Pin: 1. Ground
2. Input 3. Output

SOP-8

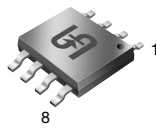

Pin: 1. Vout 2. Vin 3. Vin 4. Nc
5. Ground 6. Vin 7. Vin 8. Nc

Voltage Range
5 to 24 Volts
Current
100 Amperes

Features

- ◇ No External Components Required
- ◇ Internal Short-Circuit Current Limiting
- ◇ Internal Thermal Overload Protection
- ◇ Complementary Positive Regulators Offered (TS78L00 Series)
- ◇ Wide Range of Available, Fixed Output Voltages
- ◇ Available in $\pm 4\%$ Voltage Tolerance

Ordering Informations

Device	Operating Temperature (Ambient)	Package
TS79LxxCT	-20°C to +85°C	TO-92
TS79LxxCS		SOP-8
TS79LxxCY		SOT-89

Absolute Maximum Ratings (T_A = +25°C)

Parameter	Symbol	Value	Unit
Input Voltage	V _{in} *1	-35	V
Input Voltage	V _{in} *2	-40	V
Storage Temperature	T _{stg}	-65 to 150	°C
Junction Temperature Range	T _J	0 to 150	°C

Note: *1: TS79L05
*2: TS79L12, TS79L15, TS79L18

Standard Application

SOP-8 is an internally modified SO-8 Package. Pins 2, 3, 6 and 7 are electrically common to the die attach flag. This internal lead frame modification decreases package thermal resistance and increases power dissipation capability when appropriately mounted on a printed circuit board. SOP-8 conforms to all external dimensions of the standard SO-8 Package.

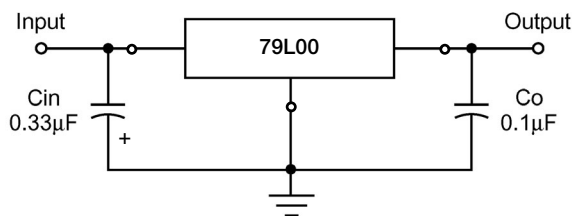

Representative Circuit Schematic

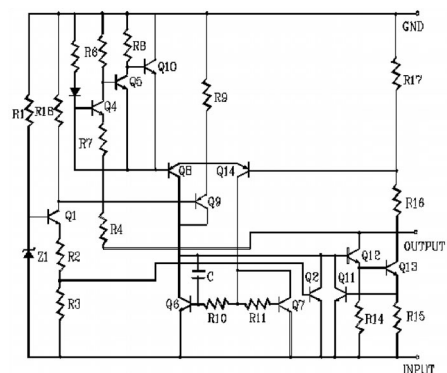

Rev. 1 04/2003



TS79L05 Electrical Characteristics ($V_I = -10V$, $I_O = 40mA$, $C_I = 0.33\mu F$, $C_O = 0.1\mu F$, $0^\circ C < T_J < 125^\circ C$ unless otherwise noted.)					
Characteristics	Symbol	Min	Typ	Max	Unit
Output Voltage ($T_J = +25^\circ C$)	V_O	-4.8	-5.0	-5.2	Vdc
Line Regulation ($T_J = +25^\circ C$) $-7.0Vdc \geq V_I \geq -20Vdc$ $-8.0Vdc \geq V_I \geq -20Vdc$	REGline	--	--	150 100	mV mV
Load Regulation $T_J = +25^\circ C$, $1.0mA \leq I_O \leq 100mA$ $1.0mA \leq I_O \leq 40mA$	REGload	--	--	60 30	mV mV
Output Voltage $-7.0Vdc \geq V_I \geq -20Vdc$, $1.0mA \leq I_O \leq 40mA$ $V_I = -10Vdc$, $1.0mA \leq I_O \leq 70mA$	V_O	-4.75 -4.75	--	-5.25 -5.25	Vdc Vdc
Input Bias Current ($T_J = +25^\circ C$) ($T_J = +125^\circ C$)	I_{IB}	--	--	6.0 5.5	mA mA
Input Bias Current Change $-8.0Vdc \geq V_I \geq -20Vdc$ $1.0mA \leq I_O \leq 40mA$	ΔI_{IB}	--	--	1.5 0.1	mA mA
Output Noise Voltage ($T_A = +25^\circ C$, $10Hz \leq f \leq 100kHz$)	V_n	--	40	--	μV
Ripple Rejection ($-8.0 \geq V_I \geq -18Vdc$, $f = 120Hz$, $T_J = 25^\circ C$)	RR	41	49	--	dB
Dropout Voltage ($I_O = 40mA$, $T_J = +25^\circ C$)	$ V_I - V_O $	--	1.7	--	Vdc
TS79L09 Electrical Characteristics ($V_I = -15V$, $I_O = 40mA$, $C_I = 0.33\mu F$, $C_O = 0.1Mf$, $-40^\circ C < T_J < +125^\circ C$ (for TS78lxx), $0^\circ C < t_j < 125^\circ C$ (TS78lxx), unless otherwise noted.)					
Characteristics	Symbol	Min	Typ	Max	Unit
Output Voltage ($T_J = +25^\circ C$)	V_O	-8.6	-9.0	-9.4	Vdc
Line Regulation ($T_J = +25^\circ C$, $I_O = 40mA$) $-11.5V \leq V_I \leq -24V$ $-12V \leq V_I \leq -24V$	REGline	--	--	175 125	mV mV
Load Regulation $T_J = +25^\circ C$, $1.0mA \leq I_O \leq 100mA$ $T_J = +25^\circ C$, $1.0mA \leq I_O \leq 40mA$	REGload	--	--	90 40	mV mV
Output Voltage $-11.5V \leq V_I \leq -24V$, $1.0mA \leq I_O \leq 40mA$ $V_I = 15V$, $1.0mA \leq I_O \leq 70mA$	V_O	-8.5 -8.5	--	-9.5 -9.5	Vdc Vdc
Input Bias Current ($T_J = +25^\circ C$) ($T_J = +125^\circ C$)	I_{IB}	--	--	6.0 5.5	mA mA
Input Bias Current Change $-11V \leq V_I \leq -23V$ $1.0mA \leq I_O \leq 40mA$	ΔI_{IB}	--	--	1.5 0.1	mA mA
Output Noise Voltage ($T_A = +25^\circ C$, $10Hz \leq f \leq 100kHz$)	V_n	--	60	--	μV
Ripple Rejection ($I_O = 40mA$, $f = 120Hz$, $-12V \leq V_I \leq -23V$, $T_J = +125^\circ C$)	RR	37	57	--	dB
Dropout Voltage ($T_J = +25^\circ C$)	$V_i - V_o$	--	1.7	--	Vdc

Rev. 1 04/2003



TS79L12 Electrical Characteristics					
(V _I = -19V, I _O = 40mA, C _I = 0.33μF, C _O = 0.1μF, 0°C < T _J < 125°C unless otherwise noted.)					
Characteristics	Symbol	Min	Typ	Max	Unit
Output Voltage (T _J = +25°C)	V _O	-11.5	-12	-12.5	Vdc
Line Regulation (T _J = +25°C)	REG _{line}	--	--	250	mV
-14.5Vdc ≥ V _I ≥ -27Vdc		--	--	200	mV
-16Vdc ≥ V _I ≥ -27Vdc		--	--		
Load Regulation	REG _{load}	--	--	100	mV
T _J = +25°C, 1.0mA ≤ I _O ≤ 100mA		--	--	50	mV
1.0mA ≤ I _O ≤ 40mA		--	--		
Output Voltage	V _O	-11.4	--	-12.6	Vdc
-14.5Vdc ≥ V _I ≥ -27Vdc, 1.0mA ≤ I _O ≤ 40mA		-11.4	--	-12.6	Vdc
V _I = -19Vdc, 1.0mA ≤ I _O ≤ 70mA					
Input Bias Current	I _{IB}	--	--	6.5	mA
(T _J = +25°C)		--	--	6.0	mA
(T _J = +125°C)		--	--		
Input Bias Current Change	ΔI _{IB}	--	--	1.5	mA
-16Vdc ≥ V _I ≥ -27Vdc		--	--	0.2	mA
1.0mA ≤ I _O ≤ 40mA		--	--		
Output Noise Voltage (T _A = +25°C, 10Hz ≤ f ≤ 100kHz)	V _n	--	80	--	μV
Ripple Rejection (-15 ≥ V _I ≥ -25Vdc, f = 120Hz, T _J = 25°C)	RR	37	42	--	dB
Dropout Voltage (I _O = 40mA, T _J = +25°C)	V _I - V _O	--	1.7	--	Vdc
TS79L15 Electrical Characteristics					
(V _I = -23V, I _O = 40mA, C _I = 0.33μF, C _O = 0.1μF, 0°C < T _J < 125°C unless otherwise noted.)					
Characteristics	Symbol	Min	Typ	Max	Unit
Output Voltage (T _J = +25°C)	V _O	-14.4	-15	-15.6	Vdc
Line Regulation (T _J = +25°C)	REG _{line}	--	--	300	mV
-17.5Vdc ≥ V _I ≥ -30Vdc		--	--	250	mV
-20Vdc ≥ V _I ≥ -30Vdc		--	--		
Load Regulation	REG _{load}	--	--	150	mV
T _J = +25°C, 1.0mA ≤ I _O ≤ 100mA		--	--	75	mV
1.0mA ≤ I _O ≤ 40mA		--	--		
Output Voltage	V _O	-14.25	--	-15.75	Vdc
-17.5Vdc ≥ V _I ≥ -30Vdc, 1.0mA ≤ I _O ≤ 40mA		-14.25	--	-15.75	Vdc
V _I = -23Vdc, 1.0mA ≤ I _O ≤ 70mA					
Input Bias Current	I _{IB}	--	--	6.5	mA
(T _J = +25°C)		--	--	6.0	mA
(T _J = +125°C)		--	--		
Input Bias Current Change	ΔI _{IB}	--	--	1.5	mA
-20Vdc ≥ V _I ≥ -30Vdc		--	--	0.1	mA
1.0mA ≤ I _O ≤ 40mA		--	--		
Output Noise Voltage (T _A = +25°C, 10Hz ≤ f ≤ 100kHz)	V _n	--	90	--	μV
Ripple Rejection (-18.5Vdc ≥ V _I ≥ -28.5Vdc, f = 120Hz)	RR	34	39	--	dB
Dropout Voltage (I _O = 40mA, T _J = +25°C)	V _I - V _O	--	1.7	--	Vdc

Rev. 1 04/2003



TS79L18 Electrical Characteristics					
(V _I = -27V, I _O =40mA, C _I = 0.33μF, C _O = 0.1 μF, 0°C<T _J <125°C unless otherwise noted.)					
Characteristics	Symbol	Min	Typ	Max	Unit
Output Voltage (T _J =+25°C)	V _O	-17.3	-18	-18.7	Vdc
Line Regulation (T _J =+25°C)	REG _{line}	--	--	325	mV
-20.7Vdc ≥ V _I ≥ -33Vdc		--	--	275	mV
-21Vdc ≥ V _I ≥ -33Vdc		--	--		
Load Regulation	REG _{load}	--	--	170	mV
T _J =+25°C, 1.0mA ≤ I _O ≤ 100mA		--	--	85	mV
1.0mA ≤ I _O ≤ 40mA		--	--		
Output Voltage	V _O	-17.1	--	-18.9	Vdc
-20.7Vdc ≥ V _I ≥ -33Vdc, 1.0mA ≤ I _O ≤ 40mA		-17.1	--	-18.9	Vdc
V _I =-27Vdc, 1.0mA ≤ I _O ≤ 70mA					
Input Bias Current	I _{IB}	--	--	6.5	mA
(T _J =+25°C)		--	--	6.0	mA
(T _J =+125°C)					
Input Bias Current Change	ΔI _{IB}	--	--	1.5	mA
-21Vdc ≥ V _I ≥ -33Vdc		--	--	0.1	mA
1.0mA ≤ I _O ≤ 40mA					
Output Noise Voltage (T _A = +25°C, 10Hz ≤ f ≤ 100kHz)	V _n	--	150	--	μV
Ripple Rejection (-23 ≥ V _I ≥ -33Vdc, f=120Hz, T _J =25°C)	RR	33	48	--	dB
Dropout Voltage (I _O =40mA, T _J =+25°C)	V _I -V _O	--	1.7	--	Vdc
TS79L24 Electrical Characteristics					
(V _I = -33V, I _O =40mA, C _I = 0.33μF, C _O = 0.1 μF, 0°C<T _J <125°C unless otherwise noted.)					
Characteristics	Symbol	Min	Typ	Max	Unit
Output Voltage (T _J =+25°C)	V _O	-23	-24	-25	Vdc
Line Regulation (T _J =+25°C)	REG _{line}	--	--	350	mV
-27Vdc ≥ V _I ≥ -38Vdc		--	--	300	mV
-28Vdc ≥ V _I ≥ -38Vdc		--	--		
Load Regulation	REG _{load}	--	--	200	mV
T _J =+25°C, 1.0mA ≤ I _O ≤ 100mA		--	--	100	mV
1.0mA ≤ I _O ≤ 40mA					
Output Voltage	V _O	-22.8	--	-25.2	Vdc
-27Vdc ≥ V _I ≥ -38Vdc, 1.0mA ≤ I _O ≤ 40mA		-22.8	--	-25.2	Vdc
V _I =-33Vdc, 1.0mA ≤ I _O ≤ 70mA					
Input Bias Current	I _{IB}	--	--	6.5	mA
(T _J =+25°C)		--	--	6.0	mA
(T _J =+125°C)					
Input Bias Current Change	ΔI _{IB}	--	--	1.5	mA
-28Vdc ≥ V _I ≥ -38Vdc		--	--	0.1	mA
1.0mA ≤ I _O ≤ 40mA					
Output Noise Voltage (T _A = +25°C, 10Hz ≤ f ≤ 100kHz)	V _n	--	200	--	μV
Ripple Rejection (-29 ≥ V _I ≥ -35Vdc, f=120Hz, T _J =25°C)	RR	31	47	--	dB
Dropout Voltage (I _O =40mA, T _J =+25°C)	V _I -V _O	--	1.7	--	Vdc

Rev. 1 04/2003



FIG. 1 - DROPOUT CHARACTERISTICS

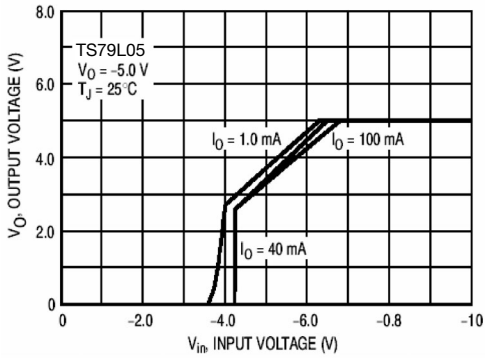

FIG. 2 - DROPOUT VOLTAGE versus JUNCTION TEMPERATURE

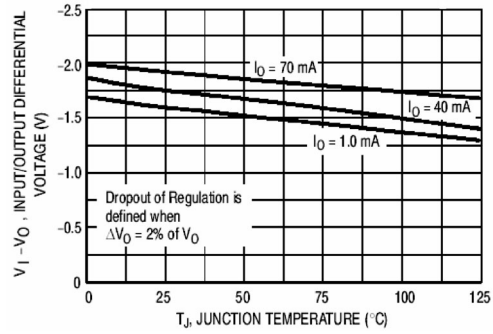

FIG. 3 - INPUT BIAS CURRENT versus AMBIENT TEMPERATURE

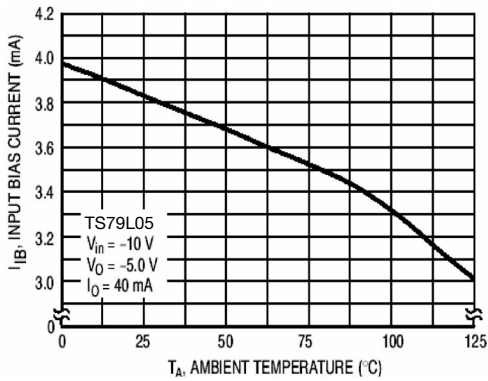

FIG. 4 - INPUT BIAS CURRENT versus INPUT VOLTAGE

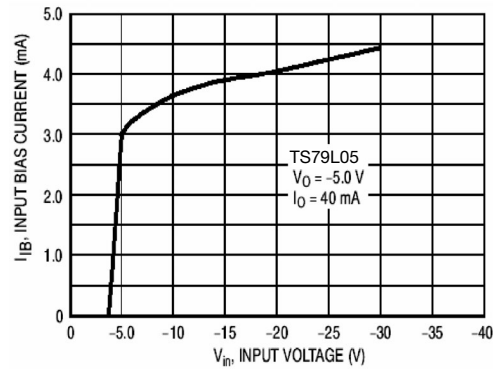
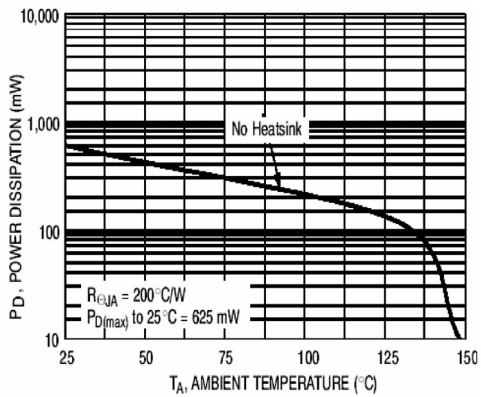

FIG. 5 - MAXIMUM AVERAGE POWER DISSIPATION versus AMBIENT TEMPERATURE - TO-92 Type Package



Applications Information

Design Considerations

The TS79L00 Series of fixed voltage regulators are designed with Thermal Overload Protection that shuts down the circuit when subjected to an excessive power overload condition, Internal Short-Circuit Protection that limits the maximum current the circuit will pass.

In many low current applications, compensation capacitors are not required. However, it is recommended that the regulator input be bypassed with a capacitor if the regulator is connected to the power supply filter with long wire lengths, or if the output load capacitance is large. An input bypass capacitor should be selected to provide good high-frequency characteristics to insure stable operation under all load conditions. A $0.33\mu\text{F}$ or larger tantalum, mylar, or other capacitor having low internal impedance at high frequencies should be used to minimize ground loops and lead resistance drops since the regulator has no external sense lead. Bypassing the output is also recommended.

FIG. 6 - POSITIVE AND NEGATIVE REGULATOR

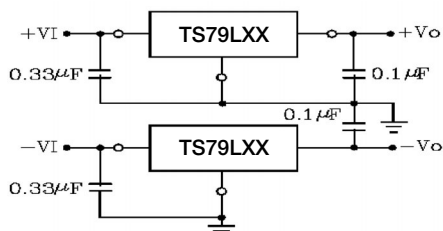
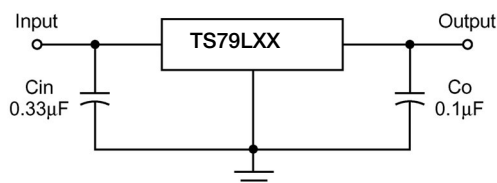

FIG. 7 - STANDARD APPLICATION



A common ground is required between the input and the output voltages. The input voltage must remain typically 2.0V above the output voltage even during the low point on the input ripple voltage.

C_I is required if regulator is located an appreciable distance from power supply filter.

C_O improves stability and transient response.

TO-92 Mechanical drawing

Unit: mm

1. Top View

4.5 ± 0.2

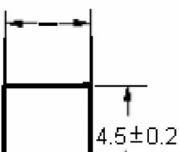

4.5 ± 0.2

14.3 TYP

0.46 ± 0.025

2. Side View

0.25 ± 0.31

0.4 ± 0.025

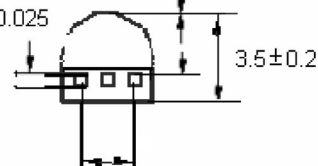

3.5 ± 0.2

2.54 ± 0.12



SOT-89 Mechanical drawing

Unit: mm

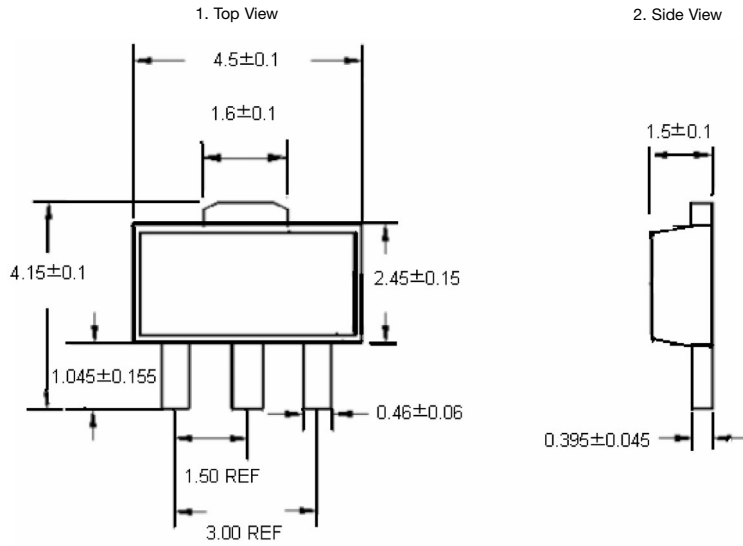

SOP-8 Mechanical drawing

SOP-8 DIMENSION

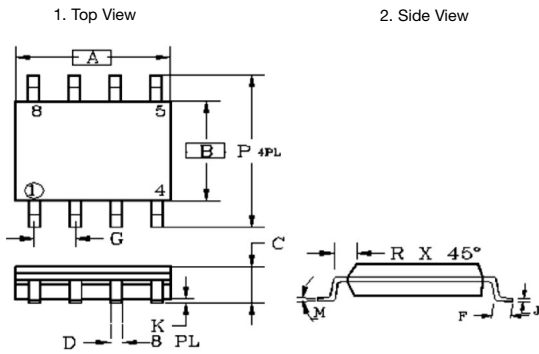

DIM	MILLIMETERS		INCHES	
	MIN	MAX	MIN	MAX
A	4.80	5.00	0.189	0.196
B	3.80	4.00	0.150	0.157
C	1.35	1.75	0.054	0.068
D	0.35	0.49	0.014	0.019
F	0.40	1.25	0.016	0.049
G	1.27BSC		0.05BSC	
K	0.10	0.25	0.004	0.009
M	0°	7°	0°	7°
P	5.80	6.20	0.229	0.244
R	0.25	0.50	0.010	0.019

Rev. 1 04/2003