

Piezoelectric Sound Components



Piezoelectric Sounders External Drive Pin Type

Now microcomputers are widely used for microwave ovens, air conditioners, cars, toys, timers, and other alarm equipment. Externally driven piezoelectric sounders are used in digital watches, electronic calculators, telephones and other equipment. They are driven by a signal (ex: 2048Hz or 4096Hz) from an LSI and provide melodious sound.

■ Features

1. Low power consumption
2. No contacts therefore, no noise and highly reliable

■ Applications

1. Telephone ringers
2. Various office equipment such as PPCs, printers and keyboards
3. Various home appliances such as microwave ovens
4. Confirmation sound of various audio equipment

PKM13EPY-4002-B0

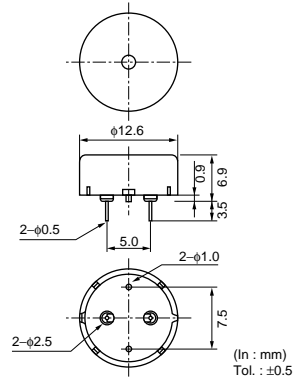

PKM17EPP-2002-B0

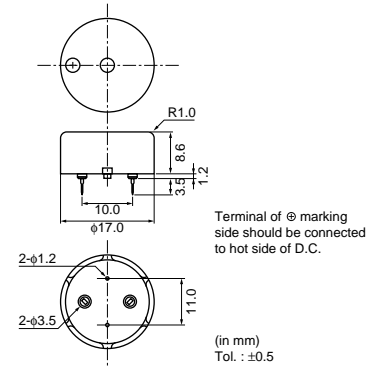

PKM17EPP-4001-B0

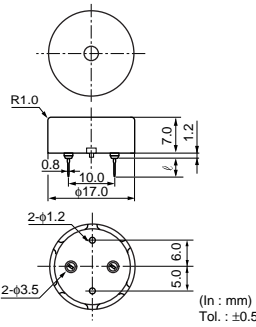

Part Number	ℓ
PKM17EPP-4001-B0	6.5
PKM17EPP-4002-B0	3.5

PKM17EPT-4001-B0

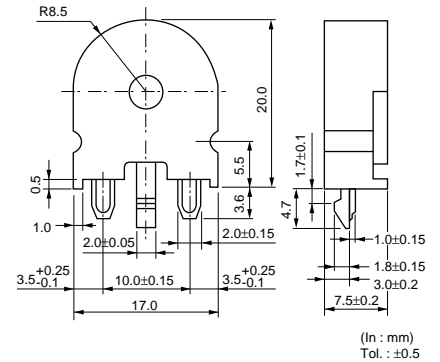

PKM22EP-2001

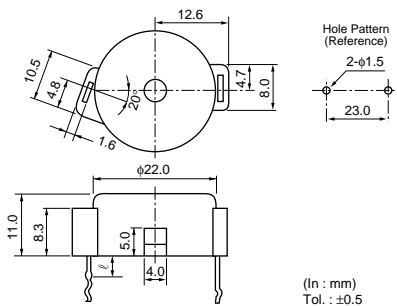

Part Number	ℓ
PKM22EP-2001	4.0
PKM22EP-2002	8.0
PKM22EP-2003	12.0

PKM22EPP-2001-B0

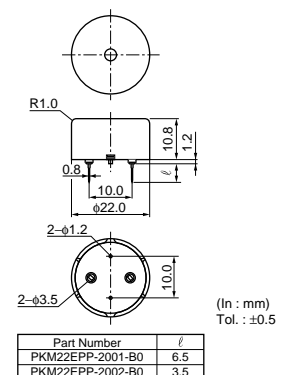

Part Number	ℓ
PKM22EPP-2001-B0	6.5
PKM22EPP-2002-B0	3.5

Continued on the following page. ↗

Continued from the preceding page.



PKM22EPP-4001-B0

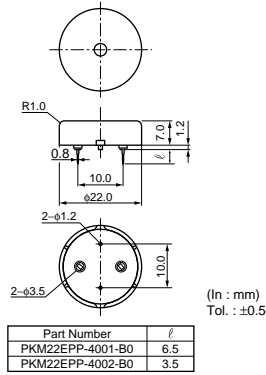

PKM22EPP-4005-B0

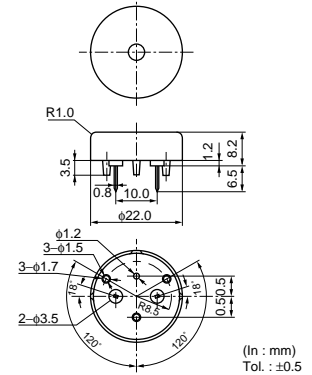

PKM22EPP-4007-B0

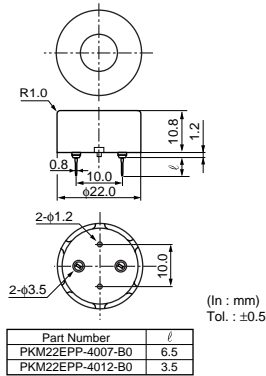

PKM22EPT-2001-B0

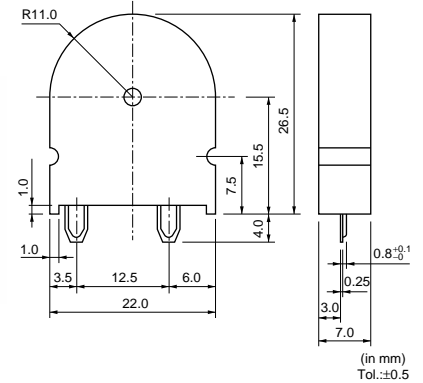

PKM22EPT-4001-B0

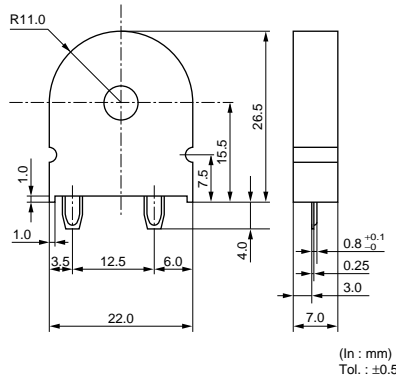

Part Number	Sound Pressure Level (dB)	Sound Pressure Level (Ref. only) (dB)	Min. of Operating Voltage Range	Capacitance (nF)	Operating Temp. Range	Storage Temp. Range
PKM13EPY-4002-B0	70 min. [3Vp-p, 4kHz, square wave, 10cm]	70 min. [1Vrms, 4kHz, sine wave, 10cm]	30 Vp-p max.	5.5 $\pm 30\%$ [1kHz]	-20 to +70°C	-30 to +80°C
PKM17EPP-2002-B0	70 min. [3Vo-p, 2kHz, square wave, 10cm]	70 min. [1Vrms, 2kHz, sine wave, 10cm]	25 Vo-p max. [with polarity]	34 $\pm 30\%$ [120Hz]	-20 to +70°C	-30 to +80°C
PKM17EPP-4001-B0	72 min. [3Vp-p, 4kHz, square wave, 10cm]	72 min. [1Vrms, 4kHz, sine wave, 10cm]	25 Vp-p max.	7 $\pm 30\%$ [1kHz]	-20 to +70°C	-30 to +80°C
PKM17EPT-4001-B0	75 min. [3Vp-p, 4kHz, square wave, 10cm]	75 min. [1Vrms, 4kHz, sine wave, 10cm]	25 Vp-p max.	9.5 $\pm 30\%$ [1kHz]	-20 to +70°C	-30 to +80°C
PKM22EP-2001	75 min. [3Vp-p, 2kHz, square wave, 10cm]	75 min. [1Vrms, 2kHz, sine wave, 10cm]	25 Vp-p max.	17 $\pm 30\%$ [120Hz]	-20 to +70°C	-30 to +80°C
PKM22EPP-2001-B0	70 min. [3Vp-p, 2kHz, square wave, 10cm]	70 min. [1Vrms, 2kHz, sine wave, 10cm]	25 Vp-p max.	19 $\pm 30\%$ [120Hz]	-20 to +70°C	-30 to +80°C
PKM22EPP-4001-B0	75 min. [3Vp-p, 4kHz, square wave, 10cm]	75 min. [1Vrms, 4kHz, sine wave, 10cm]	25 Vp-p max.	12 $\pm 30\%$ [1kHz]	-20 to +70°C	-30 to +80°C
PKM22EPP-4005-B0	75 min. [3Vp-p, 4kHz, square wave, 10cm]	75 min. [1Vrms, 4kHz, sine wave, 10cm]	25 Vp-p max.	12 $\pm 30\%$ [1kHz]	-20 to +70°C	-30 to +80°C
PKM22EPP-4007-B0	85 min. [3Vp-p, 4kHz, square wave, 10cm]	85 min. [1Vrms, 4kHz, sine wave, 10cm]	25 Vp-p max.	12 $\pm 30\%$ [1kHz]	-20 to +70°C	-30 to +80°C

Continued on the following page. ↗

↳ Continued from the preceding page.

Part Number	Sound Pressure Level (dB)	Sound Pressure Level (Ref. only) (dB)	Min. of Operating Voltage Range	Capacitance (nF)	Operating Temp. Range	Storage Temp. Range
PKM22EPT-2001-B0	70 min. [3Vp-p,2kHz,square wave,10cm]	70 min. [1Vrms,2kHz,sine wave,10cm]	25 Vp-p max.	19 ±30% [120Hz]	-20 to +70°C	-30 to +80°C
PKM22EPT-4001-B0	85 min. [3Vp-p,4kHz,square wave,10cm]	85 min. [1Vrms,4kHz,sine wave,10cm]	25 Vp-p max.	10 ±30% [1kHz]	-20 to +70°C	-30 to +80°C

2

■ Freq. Response (Square Wave 3Vp-p, 10cm)

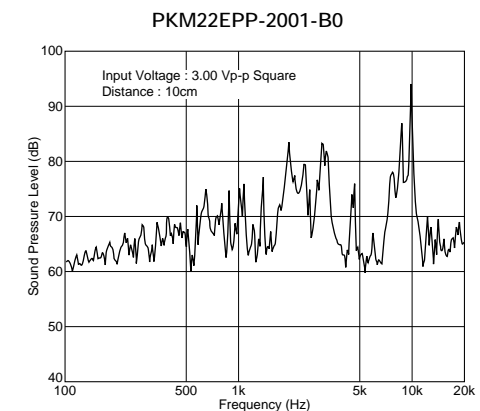
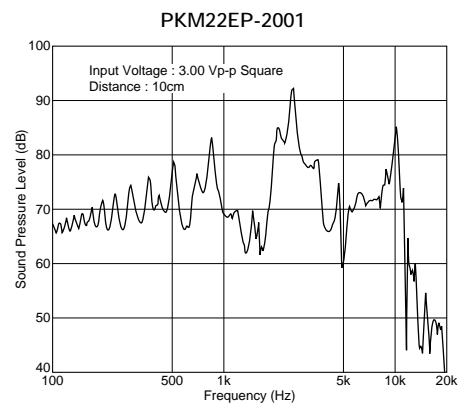
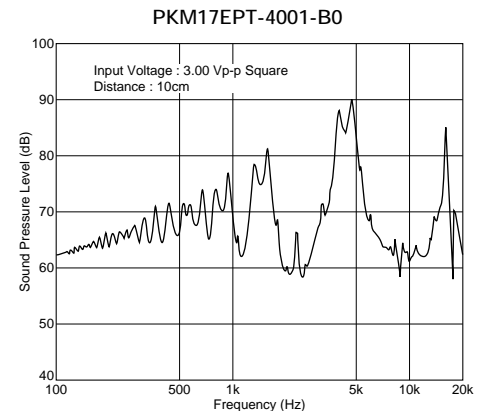
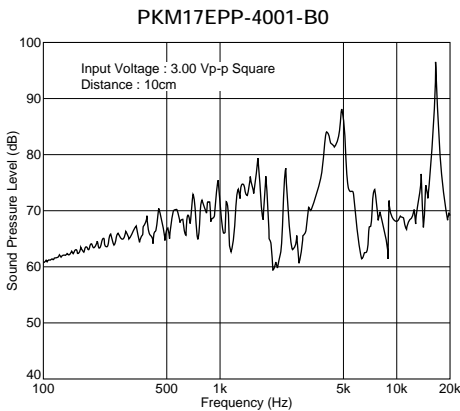
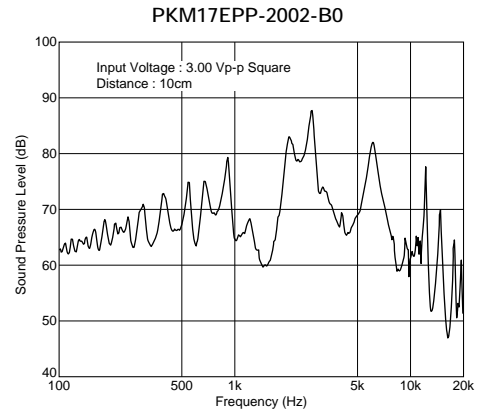
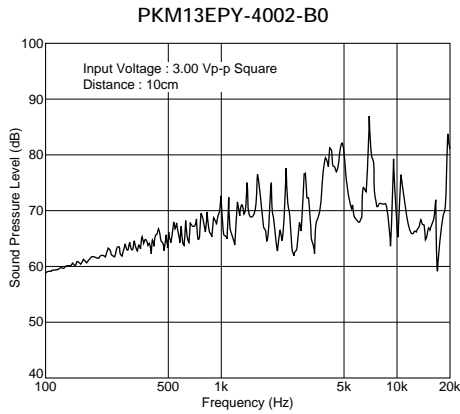

Continued on the following page. ↗

Continued from the preceding page.

■ Freq. Response (Square Wave 3Vp-p, 10cm)

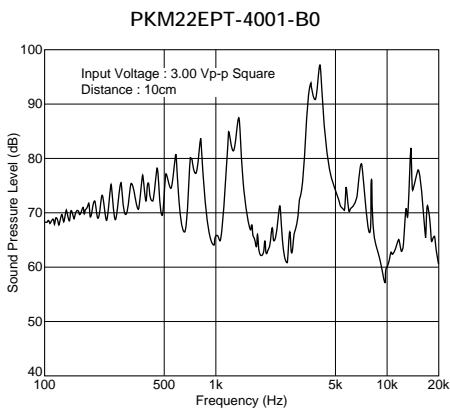
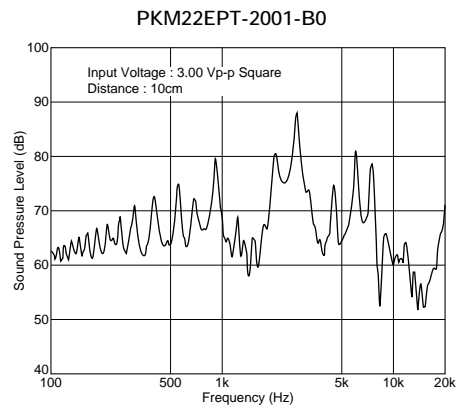
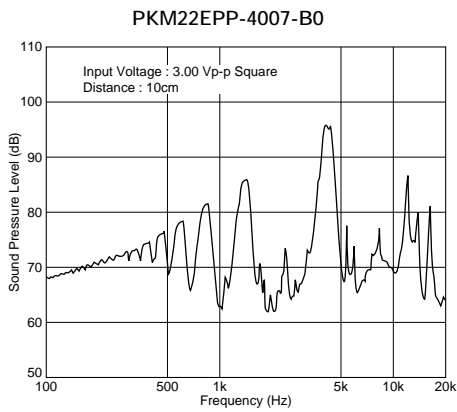
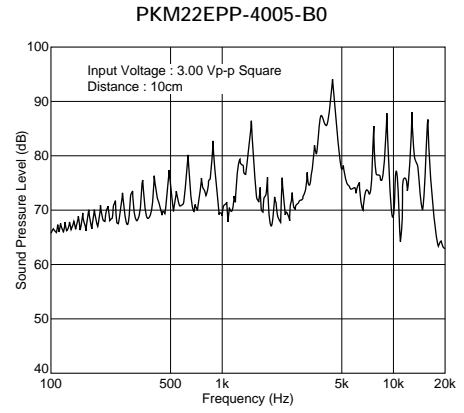
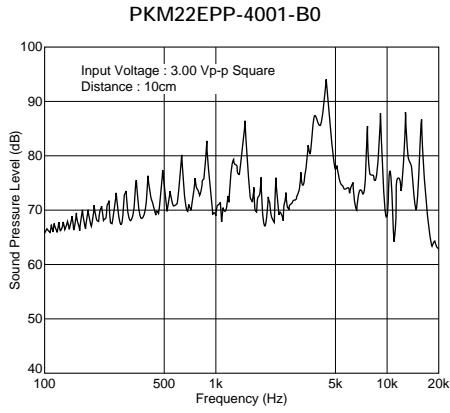

■ Freq. Response (Sine Wave 1Vrms, 10cm)

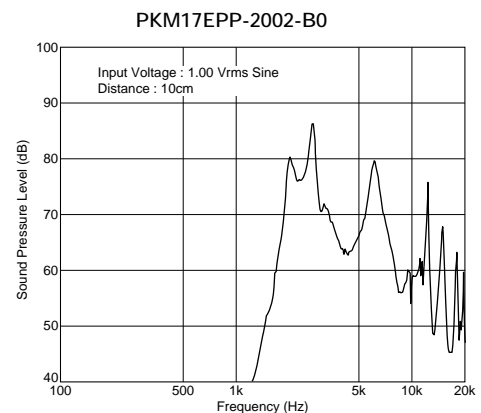
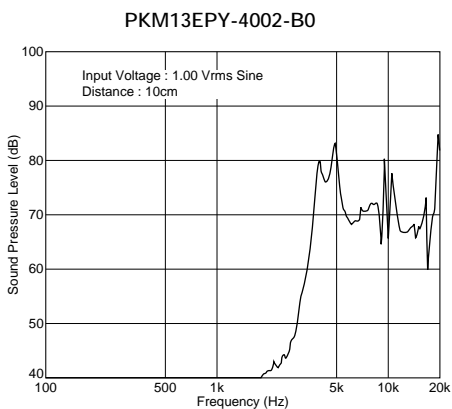

Continued on the following page. ↗

Continued from the preceding page.

Freq. Response (Sine Wave 1Vrms, 10cm)

PKM17EPP-4001-B0

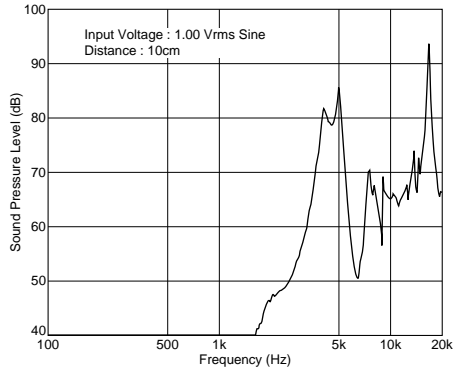

PKM17EPT-4001-B0

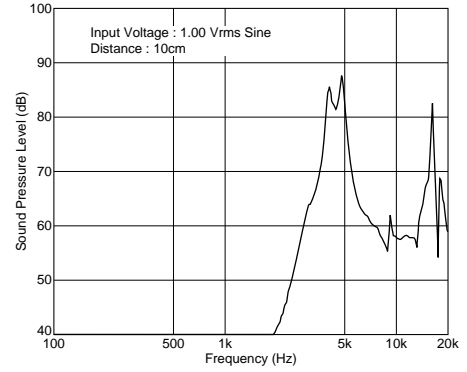

PKM22EP-2001

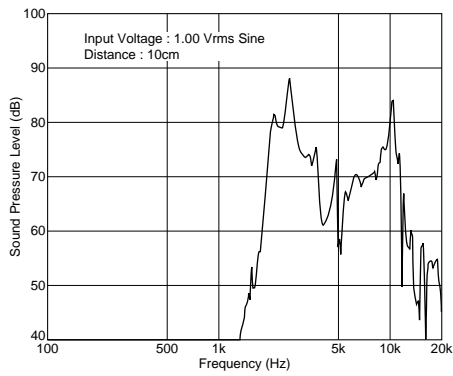

PKM22EPP-2001-B0

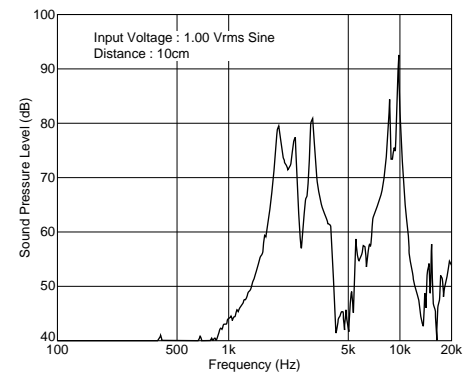

PKM22EPP-4001-B0

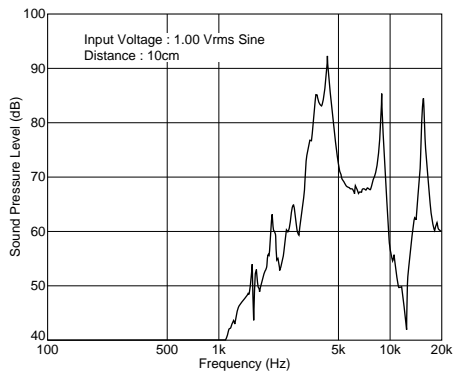

PKM22EPP-4005-B0

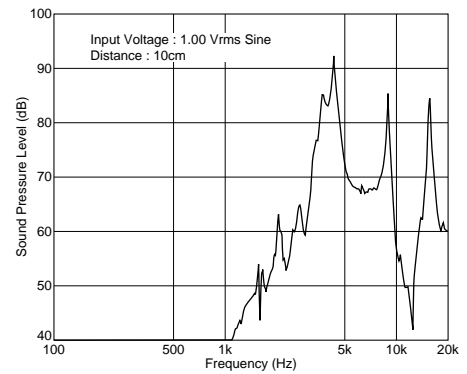

PKM22EPP-4007-B0

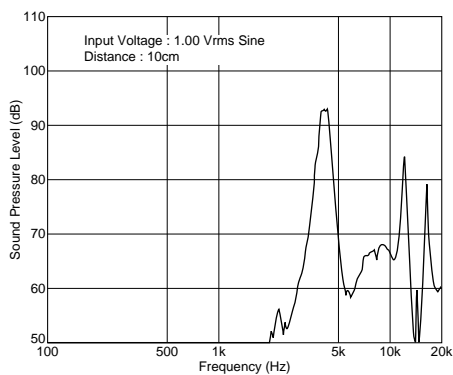

PKM22EPT-2001-B0

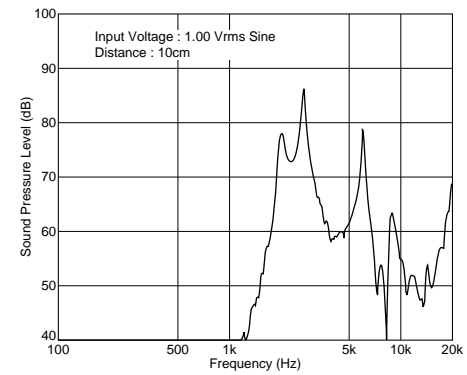

Continued on the following page.

☐ Continued from the preceding page.

■ Freq. Response (Sine Wave 1Vrms, 10cm)

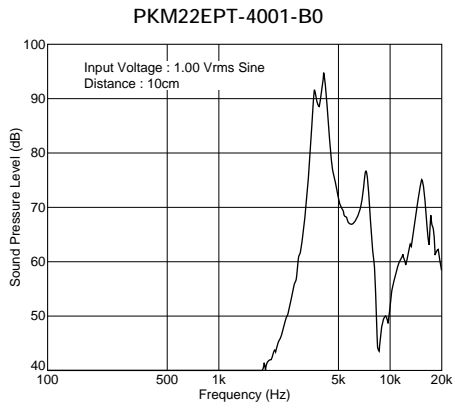

2

Piezoelectric Sound Components



Piezoelectric Sounders External Drive Pin Type Taping

Taking advantage of extensive automatic insertion design technology and materials experience, Murata has developed standard taping type piezoelectric sounder.

This Murata technology supports labor and cost saving activities.

■ Features

1. High and stable mountability
2. Ammo packaging
3. Minimum quantity (order in sets only): 500 pcs.

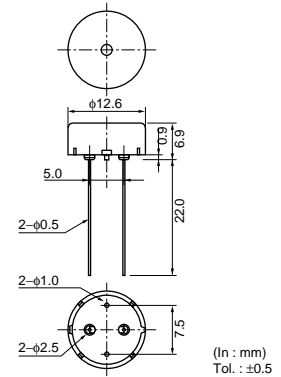
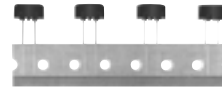

Part Number	Sound Pressure Level (dB)	Sound Pressure Level (Ref. only) (dB)	Min. of Operating Voltage Range	Capacitance (nF)	Operating Temp. Range	Storage Temp. Range
PKM13EPY-4000-A0	70 min. [3Vp-p,4kHz,square wave,10cm]	70 min. [1Vrms,4kHz,sine wave,10cm]	30 Vp-p max.	5.5 ±30% [1kHz]	-20 to +70°C	-30 to +80°C

■ Freq. Response (Square Wave 3Vp-p, 10cm)

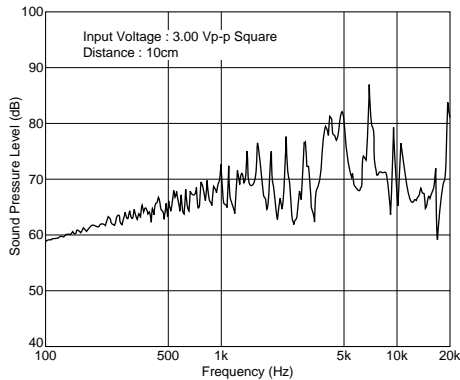

■ Freq. Response (Sine Wave 1Vrms, 10cm)

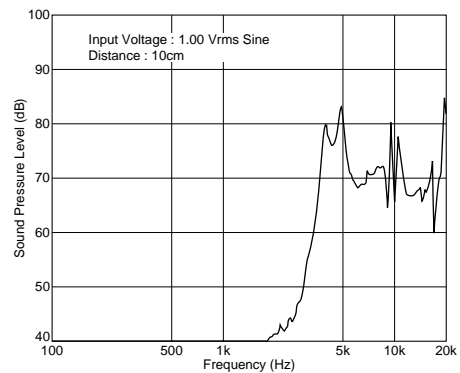

Continued on the following page. ↗

Continued from the preceding page.

Taping Dimension

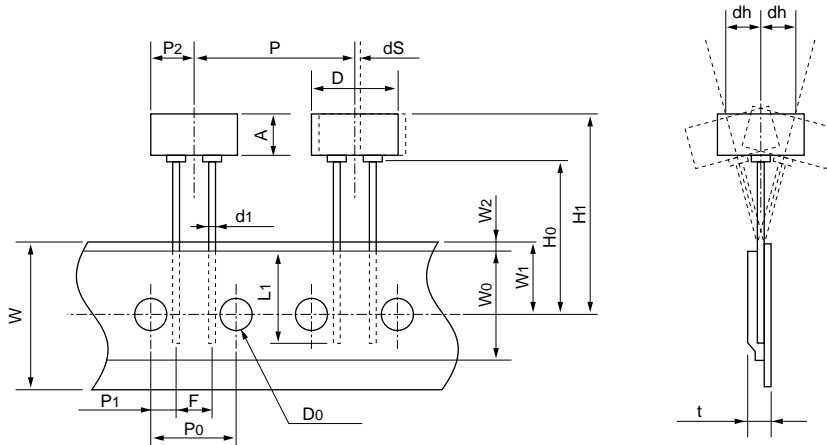

Item	Code	Nominal Value	Tol.	Remarks
Width of diameter	D	ø12.6	±0.5	
Height of component	A	6.9	±0.5	
Dimensions of terminal	d1	ø0.5	±0.1	
Lead length under the hold down tape	L1	8.0 min.	—	
Pitch of component	P	25.4	±0.5	
Pitch of sprocket	P0	12.7	±0.2	Tolerance for Pitches 10×P0=127±2mm
Length from hole center to lead	P1	3.85	±0.7	
Length from hole center to component center	P2	6.35	±0.7	
Lead spacing	F	5.0	±0.5	
Slant to the forward or backward	dh	0	±1.0	360° : 1mm max.
Width of carrier tape	W	18.0	±0.5	
Width of hold down tape	W0	12.5 min.	—	Hold down tape does not exceed the carrier tape.
Position of sprocket hole	W1	9.0	±0.5	
Gap of hold down tape and carrier tape	W2	2.0 max.	—	
Distance between the center of sprocket hole and lead stopper	H0	18.0	±0.5	
Total height of component	H1	26.0 max.	—	
Diameter of sprocket hole	D0	ø4.0	±0.2	
Total thickness of tape	t	0.6	±0.2	
Body tilt	dS	0	±1.0	

(in mm)

Piezoelectric Sound Components



Piezoelectric Sounders External Drive Lead Wire Type

Now microcomputers are widely used for microwave ovens, air conditioners, cars, toys, timers, and other alarm equipment. Externally driven piezoelectric sounders are used in digital watches, electronic calculators, telephones and other equipment. They are driven by a signal (ex: 2048Hz or 4096Hz) from an LSI and provide melodious sound.

■ Features

1. Low power consumption
2. No contacts therefore, no noise and highly reliable

■ Applications

1. Telephone ringers
2. Various office equipment such as PPCs, printers and keyboards
3. Various home appliances such as microwave ovens
4. Confirmation sound of various audio equipment

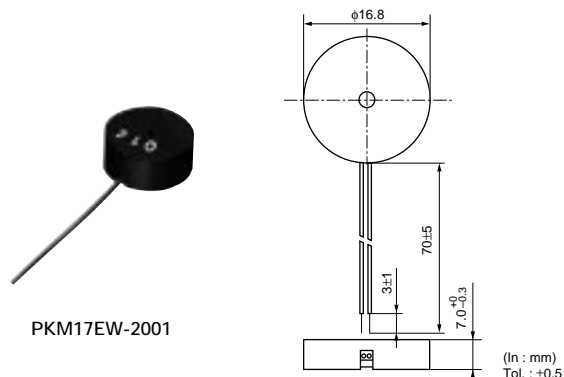

PKM17EW-2001

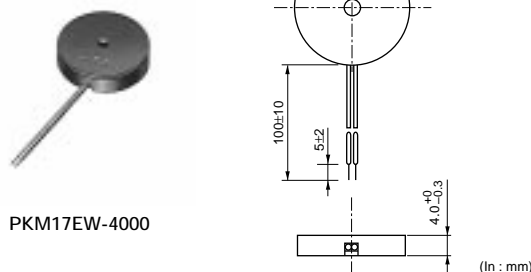

PKM17EW-4000

Part Number	Sound Pressure Level (dB)	Sound Pressure Level (Ref. only) (dB)	Min. of Operating Voltage Range	Capacitance (nF)	Operating Temp. Range	Storage Temp. Range
PKM17EW-2001	72 min. [3Vp-p,2kHz,square wave,10cm]	70 min. [1Vrms,2kHz,sine wave,10cm]	7 Vp-p max.	40 ±30% [120Hz]	-20 to +70°C	-30 to +80°C
PKM17EW-4000	75 min. [3Vp-p,4kHz,square wave,10cm]	70 min. [1Vrms,4kHz,sine wave,10cm]	25 Vp-p max.	9.5 ±30% [1kHz]	-20 to +70°C	-30 to +80°C

■ Freq. Response (Square Wave 3Vp-p, 10cm)

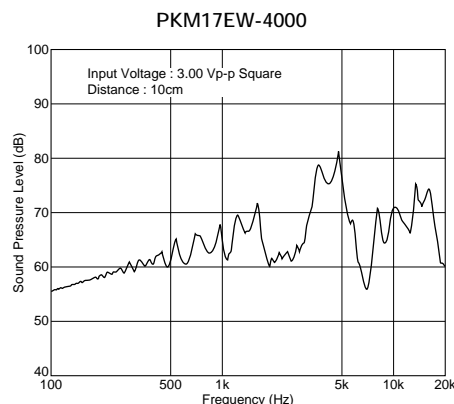
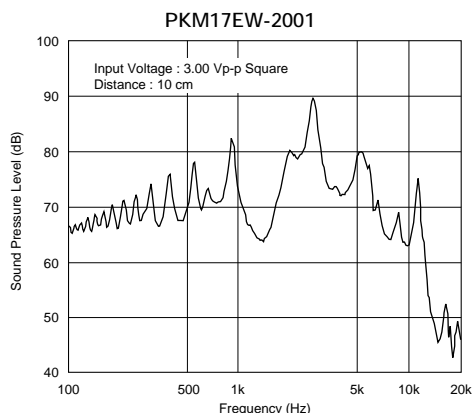

Continued on the following page.

↳ Continued from the preceding page.

■ Freq. Response (Sine Wave 1Vrms, 10cm)

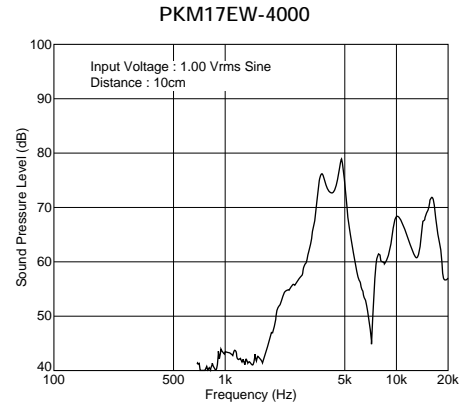
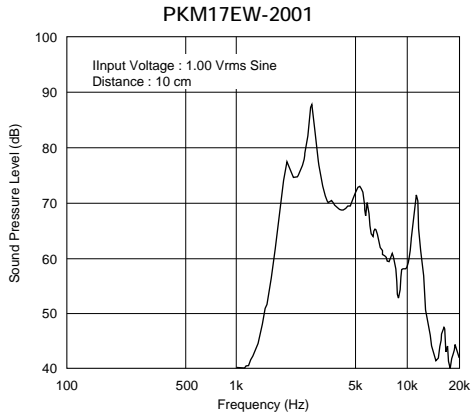

Piezoelectric Sound Components



Piezoelectric Sounders External Drive SMD Type

Taking advantage of extensive acoustic and mechanical design technology and high performance ceramics, Murata has developed SMD piezoelectric sounders that suite the thin, high-density design of electronic equipment.

■ Features

1. High S.P.L. and clear sound
2. Reflowable
3. Tape & Reel supply
4. Minimum quantity (order in sets only): 1,000 pcs.

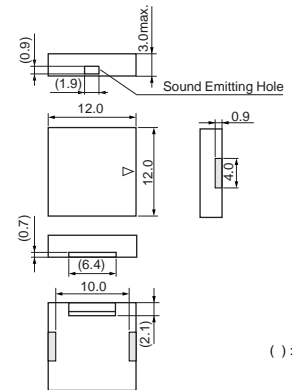

() : Ref. only
Tol. ±0.2
in mm

Part Number	Sound Pressure Level (dB)	Max. of Operating Voltage Range (Vp-p)	Operating Temp. Range	Storage Temp. Range	Use
PKLCS1212E4001-R1	75 min.[3Vp-p,4kHz,square wave,10cm]	25 max.	-20 to +70°C	-30 to +80°C	For consumer electronics
PKLCS1212E40A1-R1	75 min.[3Vp-p,4kHz,square wave,10cm]	25 max.	-40 to +85°C	-40 to +85°C	For automotive electronics

■ Standard Land Pattern Dimensions

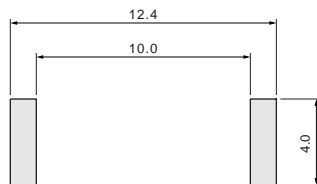

(in mm)

■ Freq. Response (Square Wave 3Vp-p, 10cm)

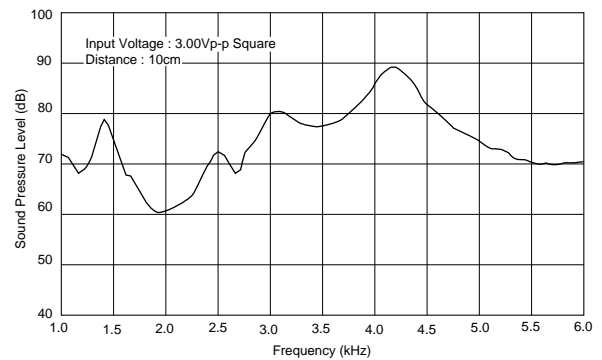

Continued on the following page. ↗

Continued from the preceding page.

Taping Dimension

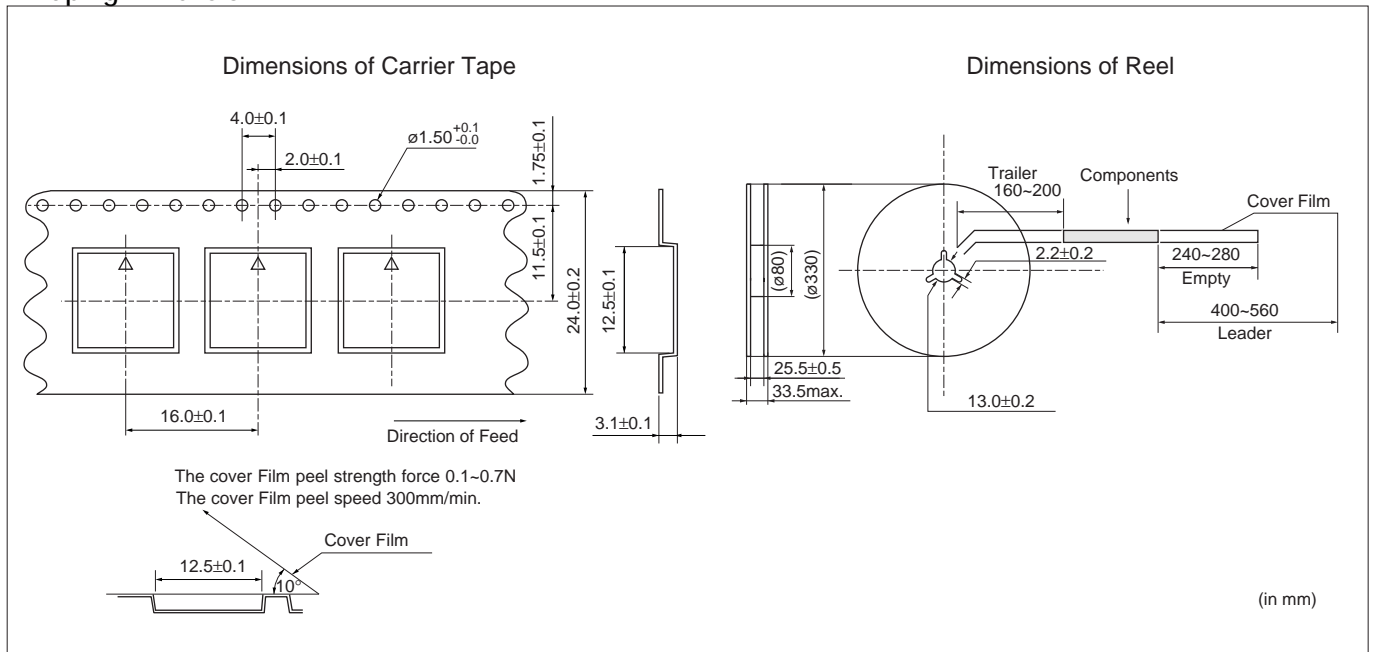

Piezoelectric Sounders (External Drive) Circuit/Notice

■ Circuit

The following are examples of externally driven circuits.

- (1) Unstable multi-vibrator using Tr.
(2) Circuits using inverters or NAND gates.

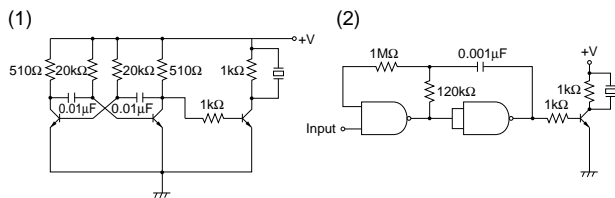

■ Notice (Soldering and Mounting)

Washing of the component is not acceptable, because it is not sealed.

■ Notice (Handling)

1. The component may be damaged if mechanical stress exceeding specifications is applied.
2. Take care to protect operating circuit from surge voltage resulting from excessive force, falling, shock or temperature change.
3. If DC voltage is applied to the component, silver migration may occur. Please pay full attention to avoid subjecting the component to DC voltage for long periods.
4. The resistor should be used as shown in Fig. A.
A suitable resistance value should be chosen, preferably 1kΩ to 2kΩ. Instead of this measure, a diode may also be applied as shown in Fig. B.

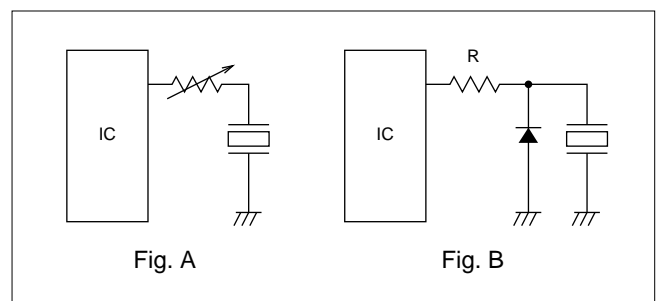

5. Avoid excessive pulling of lead wire because wire may break or soldering point may come off.