

# AN11535

## Measurement and tuning of a NFC and Reader IC antenna with a MiniVNA

Rev. 1.1 — 3 November 2014  
291911

Application note  
COMPANY PUBLIC

### Document information

Info	Content
<b>Keywords</b>	Antenna tuning, Measurement, PN512, CLRC663, NFC and Reader IC, MiniVNA
<b>Abstract</b>	This application note gives a guideline how to measure and tune/match a NFC and Reader IC antenna with the MiniVNA network analyzer tool. The MiniVNA allows a cost efficient antenna design.



## Revision history

Rev	Date	Description
1.1.	20141103	Corrections after MiniVNA user interface update
1.0	20140403	First official release

## Contact information

For more information, please visit: <http://www.nxp.com>

For sales office addresses, please send an email to: [salesaddresses@nxp.com](mailto:salesaddresses@nxp.com)

## 1. Introduction

---

### 1.1 Scope

The document will introduce the MiniVNA Pro instrument for measuring HF loop antenna parameters and antenna matching for NXP RFID transceiver.

Compared to classical Vector Network Analyzer this instrument is cheap and portable.

It can be used by technical person in a real application environment and the instrument had capability to deliver result good enough for the purpose.

NXP reference boards are tuned for optimal performance in air or with metal surfaces at distance bigger than 2 – 3 cm (distance is depending on antenna dimension).

In this Application Note will be explained how to read and interpret result from Smith Chart , how to use Mini VNA instrument for basic antenna parameter and Return Loss measurement, fundamental rules for antenna tuning adjustment are provided.

A setup where a metal surface is quite close to the antenna is evaluated, inputs for antenna retuning are given and S11 Return Loss parameter measured.

As example Blueboard [PNEV512B](#) is chosen.

### 1.2 What you need

Below the list of equipment which is needed:

- MiniVNA Pro Network Analyzer
- Calibration Kit
- USB Cable
- Windows FTDI USB driver ([www.nxp.com/redirect/ftdichip.com/Drivers/VCP](http://www.nxp.com/redirect/ftdichip.com/Drivers/VCP))
- Software Application
- PC/ Laptop with administration rights

The Calibration KIT can be a self-made one (Fig 6). The SW application can be downloaded via this link: [www.nxp.com/redirect/miniradiosolutions.com/minivnapro](http://www.nxp.com/redirect/miniradiosolutions.com/minivnapro).

## 2. Network Analyzer

### 2.1 Network Analyzer – General

A **network analyzer** is an instrument that measures the network parameters of electrical networks. Network analyzers are often used to characterize two port networks such as amplifiers and filters, but they can be used on networks with an arbitrary number of ports.

Network analyzers are used mostly at high frequencies. Operating frequencies can range from 5 Hz to 1.1 THz. Special types of network analyzers can also cover lower frequency ranges down to 1 Hz. These network analyzers can be used for example for the stability analysis of open loops or for the measurement of audio and ultrasonic components.

The two main types of network analyzers are

- **scalar network analyzer (SNA)** — measures amplitude properties only
- **vector network analyzer (VNA)** — measures both amplitude and phase properties

The basic architecture of a network analyzer involves a signal generator, a test set, one or more receivers and display. In some setups, these units are distinct instruments. Most VNAs have two test ports, permitting measurement of four S-parameters (S11, S12, S21, and S22) but instruments with more than two ports are available commercially.

Typical applications are S parameters, Amplifier Gain Compression, conversion Gain/Loss, material measurement, signal integrity.

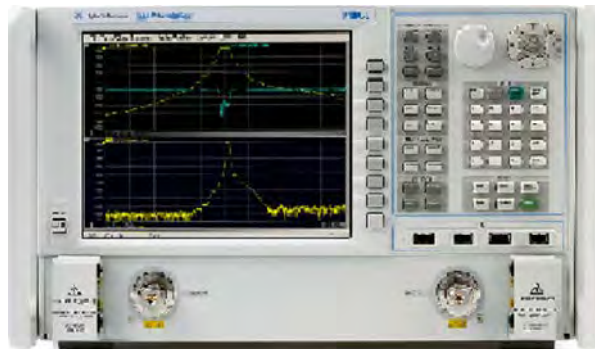

Fig 1. Agilent PNA-L Network Analyzer

This kind of Network Analyzer is offering the following features:

- 300 kHz to 20 GHz Frequency range
- 2- or 4-ports with single built-in sources
- 133 dB system dynamic range, 32,001 points, 200 channels, 15 MHz IF bandwidth
- High output power (+13 dBm)
- Low noise floor of -120 dBm (10 Hz IF bandwidth)

A Network Analyzer as the Agilent PNA-L Microwave Network Analyzer with a price of ~ 100kUSD is a big investment.

## 2.2 Mini VNA

The miniVNA PRO, by mRS: Miniradiosolution (see <http://www.nxp.com/redirect/miniradiosolutions.com>), is a small Vector Network Analyzer supporting features to measure RFID reader antennas and RF circuits for everybody who has not the budget for an expensive Network Analyzer. The miniVNA is low budget solution with the advantage that it can be used as a mobile device as well. The cost of this tool is around 600USD.



Fig 2. MiniVNA PRO PC Based Network Analyzer

Features supported by this device:

- Frequency Range from 100 kHz to 200 MHz
- Range of Z: from 1 to 1000 Ohm
- Extended Dynamic Range: up to 90 dB in Transmission & 50 dB Reflection
- Two ports VNA with S11 and S21; displayed and save results
- I/Q DDS Generator 2 channels AD9958 by Analog Devices
- Two separate buffered RF output I/Q for SDR experiment and IMD test with independent 0 - 55 dB attenuator; Phase adjustment resolution of 1 degree. Output power of 0 dBm
- Built in Bluetooth Class 1 with external antenna on PCB for remote measurements up to 100mt
- Internal Battery Li-ion with 1000 mA/h (4 hours full- scan operation)
- Built-in battery charger (up to 400 mA)
- Low power consumption, 220 mA @ 3.6 V (analyzer mode using USB port)
- Power save mode
- Accessory port for future optional interfaces and frequency extenders
- Calibration using open-short-load for accurate results
- Management by the VNA/J: User friendly FREE software interface for PC -Windows XP- Vista-Win7 / Linux and Mac (JAVA – JRE6 based) by DL2SBA, see <http://www.nxp.com/redirect/dl2sba.com/index.php>

- Measurements of motional crystal parameters, cable length, & moreExport data in several formats – JPEG, EXCEL, ZPLOT, S2P, PDF

**2.2.1 Mini VNA Driver test and calibration for S11 measurement**

As a first step a Mini VNA driver test and calibration must be done.

1. Select the menu ANALYZER->SETUP
2. Choose right driver and COM port
3. Press the buttons Test (1) & Update (2), if an error occurs, press the red button on the mini VNA and try again or select a different port.

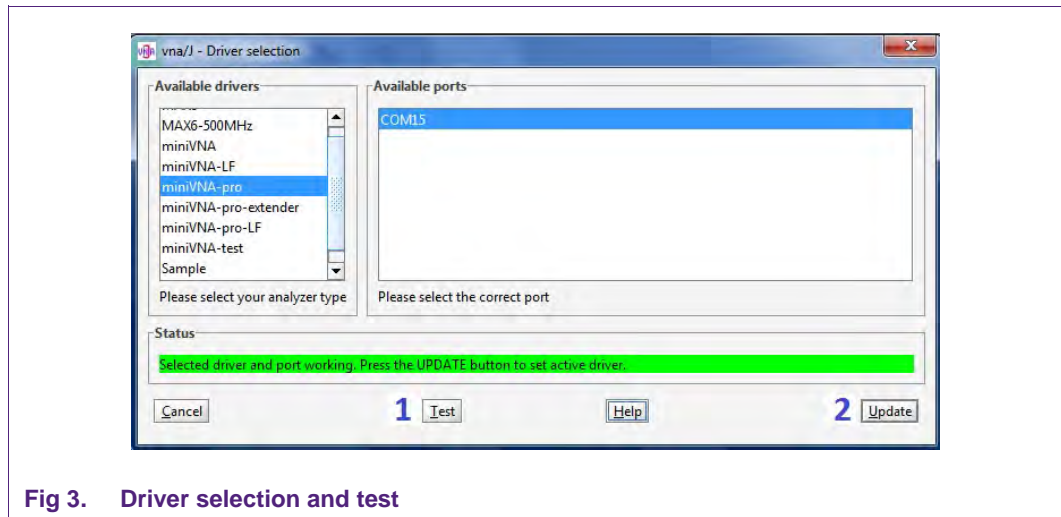

4. Select as Mode in the right bottom corner of the window “REFLEXION”
5. Select the menu CALIBRATION->CREATE



6. Calibration in a sequential order (calibration kits connected to the Mini VNA, make sure not to mix the DUT/DET connections of the MiniVNA, the calibration probe and all measurements require the connection to the DUT marked input ). As calibration frequency range, a range from e.g. 100 Hz to 25 MHz is sufficient.
  - a. OPEN
  - b. SHORT

- c. LOAD
- d. Press “save” calibration & press the “update” button (closes the window)

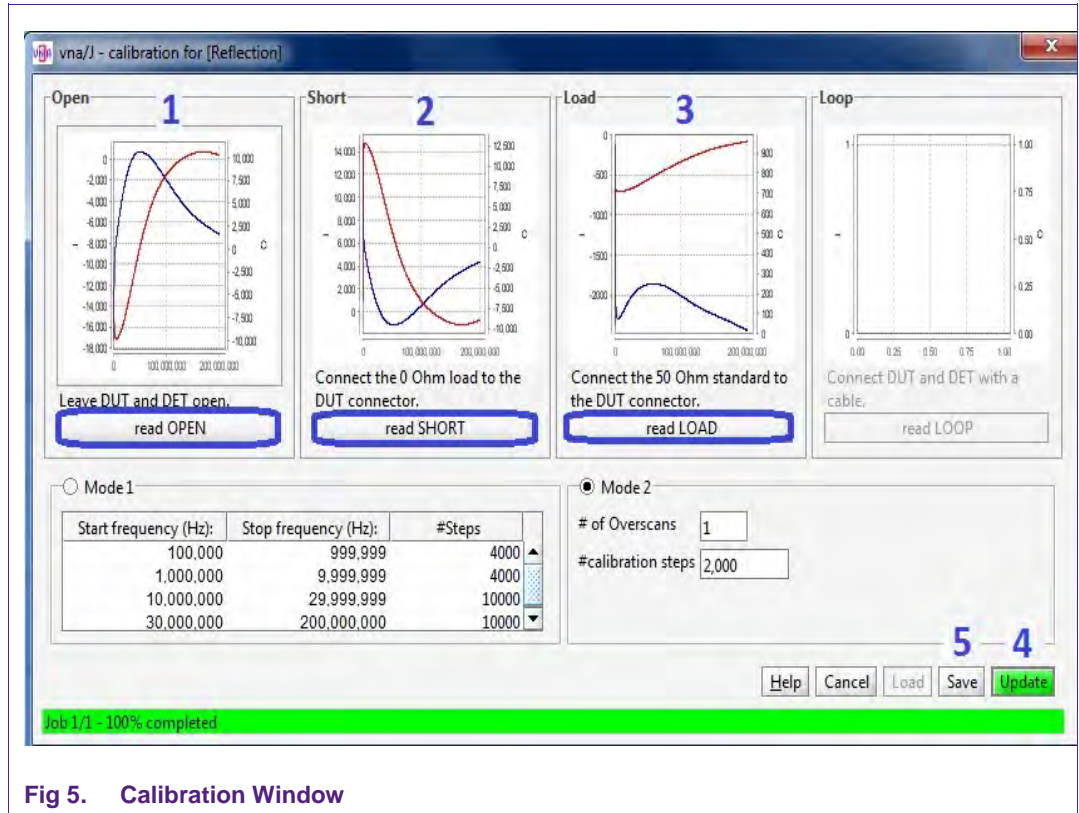

For the calibration you can use a professional calibration kit or a handmade. Click here to order an SMA kit:  
[http://www.nxp.com/redirect/wimo.com/instrumentation\\_e.html#21010sma](http://www.nxp.com/redirect/wimo.com/instrumentation_e.html#21010sma)



**Important Note:** any additional cable and wires from the calibration port to the measurement points on the PCB board should be ideally as short as possible (max. 20mm). This does not mean that the cable from the MiniVNA to the calibration port needs to have a length of 20mm. The influence of a cable between MiniVNA DUT input and calibration port is eliminated by the calibration.

### 3. Smith Chart

#### 3.1 Smith Chart – General

The Smith chart is a graphical aid or nomogram designed for electrical and electronics engineers specializing in radio frequency (RF) engineering to assist in solving problems with transmission lines and matching circuits.

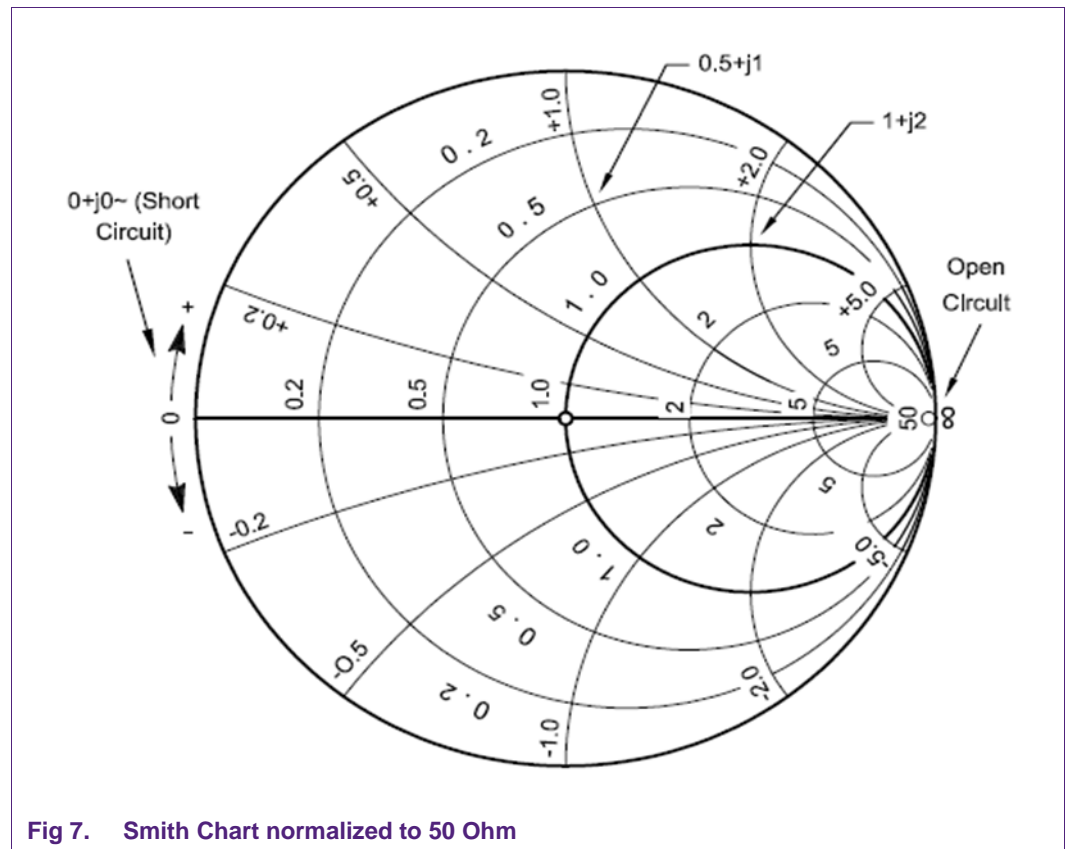

Fig 7. Smith Chart normalized to 50 Ohm

The Smith chart is plotted on the complex reflection coefficient plane in two dimensions and is scaled in normalized impedance. These are often known as the Z, Y and YZ Smith charts respectively. Normalized scaling allows the Smith chart to be used for problems involving any characteristic or system impedance which is represented by the center point of the chart. The most commonly used normalization impedance is 50 ohms.

$Z_L$  will be the load impedance. The reflection coefficient is completely determined by the impedance  $Z_L$  and the 'reference impedance'  $Z_0$ .

$Z_0$  can be viewed as the impedance of the transmitter, or what is trying to deliver power to the antenna. Hence, the Smith Chart is a graphical method of displaying the



impedance of an antenna, which can be a single point or a range of points to display the impedance as a function of frequency.

The circles in the Smith Chart shown in Fig 7 are representing the constant real part of the impedance, the other lines the constant imaginary part.

The complex reflection coefficient  $\Gamma$  for an impedance  $Z_L$  attached to a transmission line with characteristic impedance  $Z_0$  is given by:

$$\Gamma = \frac{Z_L - Z_0}{Z_L + Z_0} \tag{1}$$

For our measurement  $Z_0 = 50$  Ohm (Smith chart normalized to 50 Ohm in the graph).

The complex reflection coefficient must have a magnitude between 0 and 1.

The center of the Smith Chart is the point where the reflection coefficient is zero - this is the point where no power is reflected by the load impedance.

### 3.2 Smith Chart S11 Parameter

In practice, the most commonly quoted parameter in regards to antennas is S11. S11 represents how much power is reflected from the antenna, and hence is known as the reflection coefficient, sometimes written as gamma:  $\Gamma$  or return loss. If S11 = 0dB, then all the power is reflected from antenna and nothing is radiated. If S11 = -10 dB, this implies that if 3 dB of power is delivered to the antenna, -7dB is the reflected power.

Formula for S11 (Return Loss)

$$RL(dB) = -20\log|\Gamma| \tag{2}$$

Example1: RL = -3 dB it means that 50% of power is transmitted and 50% reflected

Example2: RL = -10 dB it means that 90% of power is transmitted and 10% reflected

For our target of Z(matching) = 50 Ohm consider to have  $|RL| > 10dB$

**Table 1. Return loss conversion table**

Return Loss [dB]	VSWR	Reflection Coefficient, G	Mismatch Loss [dB]	Reflection Power [%]	Through Power [%]	Return Loss [dB]	VSWR	Reflection Coefficient, G	Mismatch Loss [dB]	Reflection Power [%]	Through Power [%]
1	17,39	0,891	6,868	79,43	20,57	21	1,20	0,089	0,035	0,79	99,21
2	8,72	0,794	4,329	63,10	36,90	22	1,17	0,079	0,027	0,63	99,37
3	5,85	0,708	3,021	50,12	49,88	23	1,15	0,071	0,022	0,50	99,50
4	4,42	0,631	2,205	39,81	60,19	24	1,13	0,063	0,017	0,40	99,60
5	3,57	0,562	1,651	31,62	68,38	25	1,12	0,056	0,014	0,32	99,68
6	3,01	0,501	1,256	25,12	74,88	26	1,11	0,050	0,011	0,25	99,75
7	2,61	0,447	0,967	19,95	80,05	27	1,09	0,045	0,009	0,20	99,80
8	2,32	0,398	0,749	15,85	84,15	28	1,08	0,040	0,007	0,16	99,84
9	2,10	0,355	0,584	12,59	87,41	29	1,07	0,035	0,005	0,13	99,87
10	1,92	0,316	0,458	10,00	90,00	30	1,07	0,032	0,004	0,10	99,90
11	1,78	0,282	0,359	7,94	92,06	31	1,06	0,028	0,003	0,08	99,92
12	1,67	0,251	0,283	6,31	93,69	32	1,05	0,025	0,003	0,06	99,94
13	1,58	0,224	0,223	5,01	94,99	33	1,05	0,022	0,002	0,05	99,95
14	1,50	0,200	0,176	3,98	96,02	34	1,04	0,020	0,002	0,04	99,96
15	1,43	0,178	0,140	3,16	96,84	35	1,04	0,018	0,001	0,03	99,97
16	1,38	0,158	0,110	2,51	97,49	36	1,03	0,016	0,001	0,03	99,97

Return Loss [dB]	VSWR	Reflection Coefficient, G	Mismatch Loss [dB]	Reflection Power [%]	Through Power [%]	Return Loss [dB]	VSWR	Reflection Coefficient, G	Mismatch Loss [dB]	Reflection Power [%]	Through Power [%]
17	1,33	0,141	0,088	2,00	98,00	37	1,03	0,014	0,001	0,02	99,98
18	1,29	0,126	0,069	1,58	98,42	38	1,03	0,013	0,001	0,02	99,98
19	1,25	0,112	0,055	1,26	98,74	39	1,02	0,011	0,001	0,01	99,99
20	1,22	0,100	0,044	1,00	99,00	40	1,02	0,010	0,000	0,01	99,99

## 4. HF Antenna Basics

### 4.1 HF RFID Loop Antenna

#### 4.1.1 Measurement and calculation of equivalent parameters

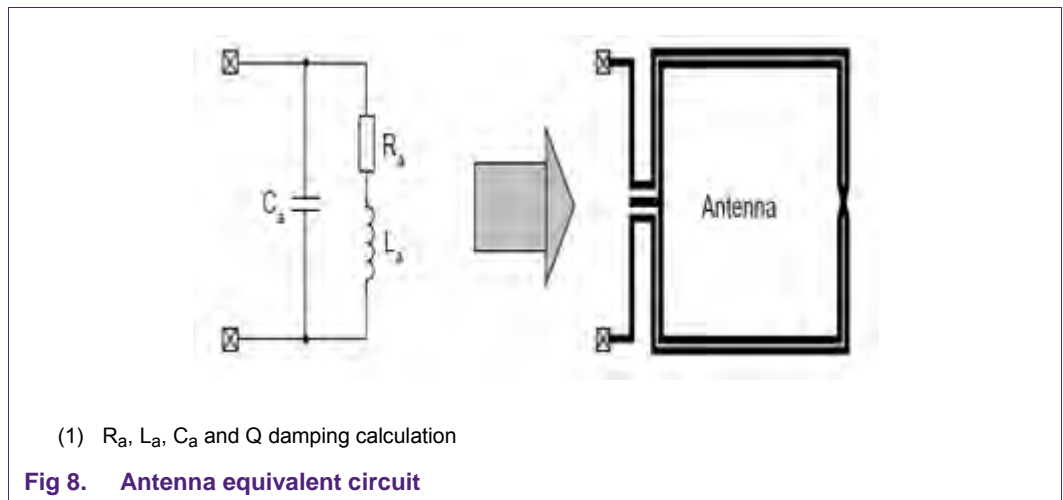

It is recommended to measure the inductance as well as the series resistance value at 1MHz.

The self-resonance frequency ( $f_{res}$ ) and the parallel resistance can be obtained at the resonant point of the system where the imaginary part is zero.

The antenna capacitance  $C_a$  can be calculated with:

$$C_a = \frac{1}{(2 \cdot \pi \cdot f_{res})^2 L_a} \tag{3}$$

### 4.2 Antenna Q Factor

The quality factor of the antenna is calculated with:

$$Q_a = \frac{\omega \cdot L_a}{R_a} \tag{4}$$

Target value for Q is 30 ( $\pm 10\%$ ), if higher an external damping resistor  $R_Q$  has to be inserted on each antenna side to reduce the Q-factor to the target value.

$$R_Q = 0,5 \cdot \left( \frac{\omega \cdot L_a}{30} - R_a \right) \quad (5)$$

4.3 NXP Recommended Matching Network: Directly matched antenna

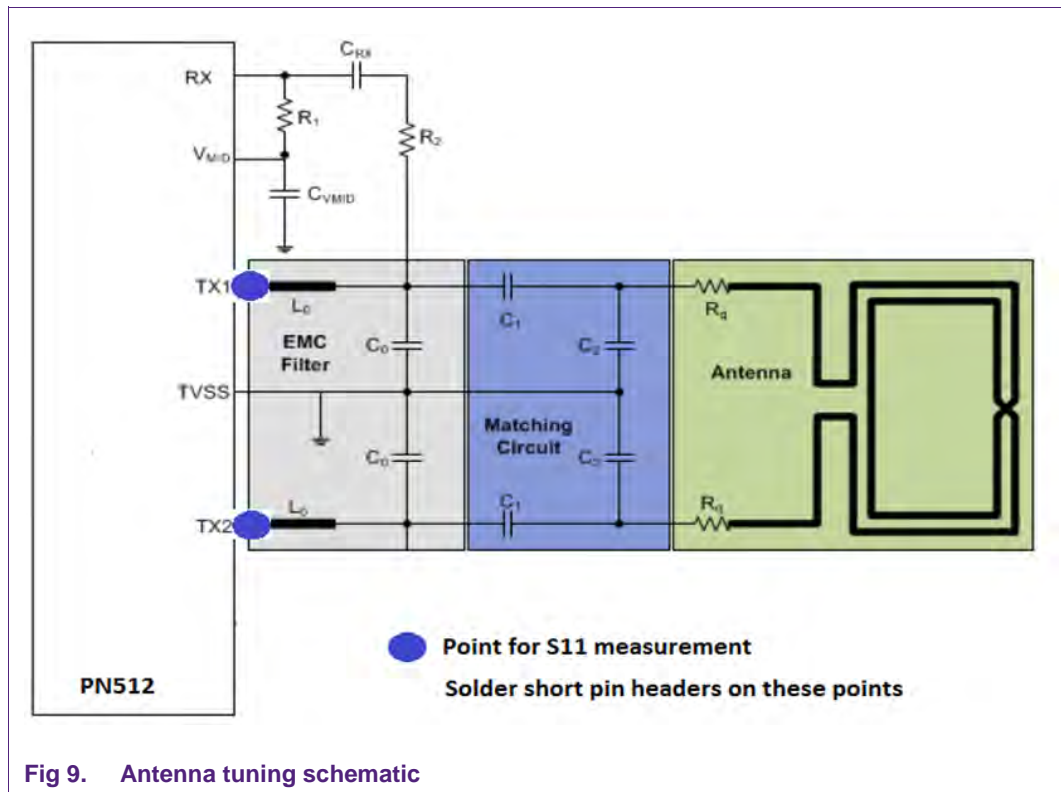

The main blocks of the schematic above are:

- EMC filter ( $L_0$ ,  $C_0$ )
- Matching circuit ( $C_1$ ,  $C_2$ )
- $R_Q$  (Q damping factor resistor)
- Antenna (can be represented with the equivalent circuit)

More detailed information about antenna matching can be found in the [NXP Antenna Design Guide](#).

### 4.4 PNEV512B Antenna measurement example

This chapter will show how to measure the electrical parameters of an antenna with the MiniVNA. As example the antenna of the [PNEV512B](#) will be used.

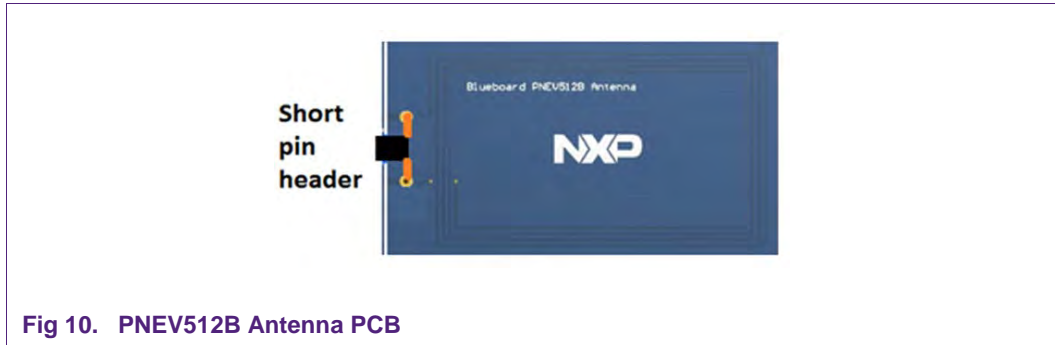

Before starting you have to remove all matching components (capacitors and resistors) or use an unpopulated antenna and follow these steps:

1. Connect MiniVNA with SMA adaptor and the antenna (short pin header)
2. Set at the MiniVNA a frequency span 1 – 5 MHz
3. Measure  $L_a(X_S)$  and  $R_a(R_S)$  at 1 MHz

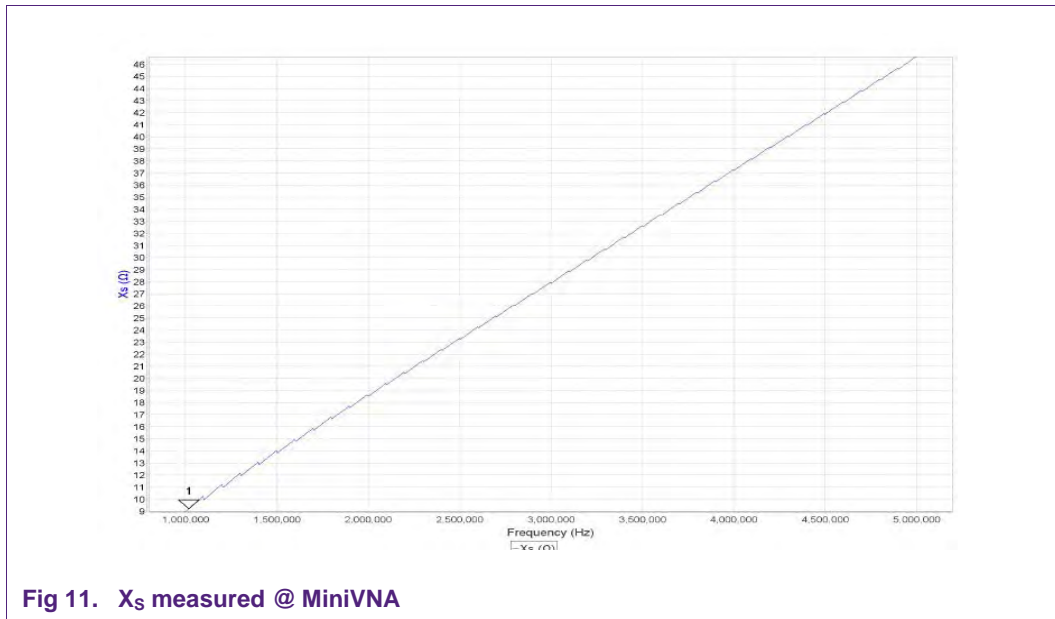

Table 2.  $R_S, X_S$  - measured antenna values

Marker	Frequency [Hz]	RL [dB]	RP [°]	TL [dB]	TP [°]	SWR	Z	$R_S$	$X_S$
1	1.017.316	-0,12	159,14	0,00	0,00	46,63	9,2	0,4	9,2

4. Out of this measurement we get for  $R_a = 0,4$  Ohm and  $X_S = 9,2$  Ohm.
5. The antenna inductance  $L_a$  and the Q damping factor resistor  $R_Q$  can be calculated (4) & (5):  $X_S = \omega L \rightarrow L_a (1\text{MHz}) = 1,46\mu\text{H}$  and  $R_Q = 1,9$  Ohm (2,2 Ohm value selected)

6. Calculation of the antenna capacitance  $C_a$ . To get this parameter the self-resonance frequency of the antenna must be measured.
  - a. Set at the MiniVNA a frequency span 1 – 100 MHz
  - b. The point where the imaginary part  $X_s$  is going from an inductive value to capacitive value (negative) is the self-resonance frequency SRF.
  - c. The measured SRF = 70,75 MHz
  - d. The capacitance  $C_a$  of the equivalent circuit can now be calculated (3)  $\rightarrow C_a = 3,46\text{pF}$

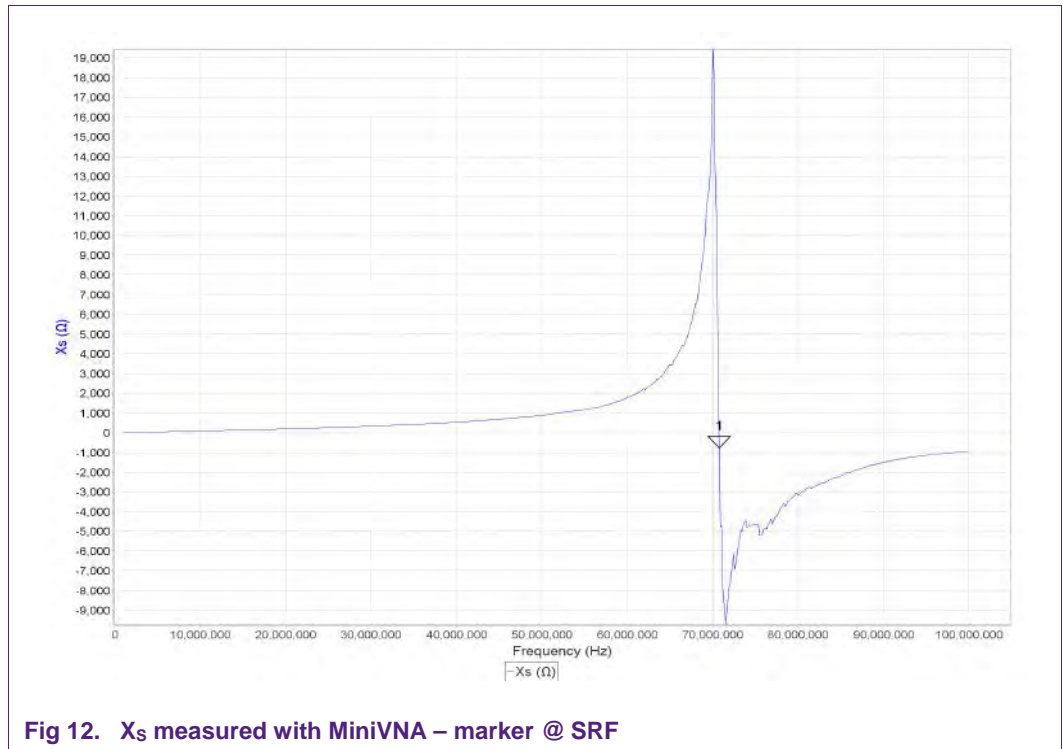

Fig 12.  $X_s$  measured with MiniVNA – marker @ SRF

Table 3.  $R_s, X_s$  - measured antenna values

Marker	Frequency [Hz]	RL [dB]	RP [°]	TL [dB]	TP [°]	SWR	Z	$R_s$	$X_s$
1	70.749.442	-0,04	-0,01	0,00	0,00	83,13	24143,7	24131,1	-780,9

5. Matching Example – based on the PNEV512B

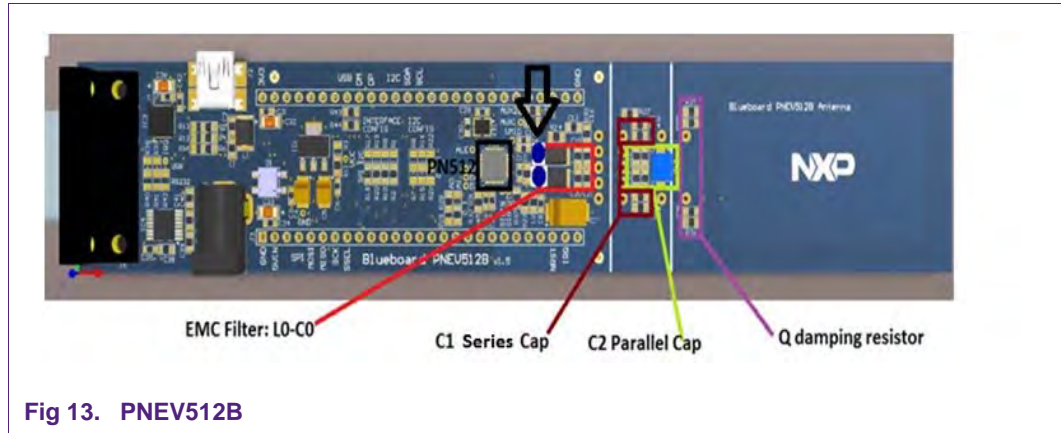

Fig 13. PNEV512B

The measurement points are marked in the Fig 13 with two blue dots. These both points are between TX1 & TX2 of the PN512 and the L<sub>0</sub> inductors of the EMC filter.

The PNEV512B is tuned for a Z target, matching to 50 Ohm (40 – 60 Ohm as optimal range):

- L<sub>0</sub> = 470 nH
- C<sub>0</sub> = 100pF + 56pF
- C<sub>1</sub> = 33 pF
- C<sub>2</sub> = 100 pF + 47 pF
- R<sub>Q</sub> = 2.2 Ohm

5.1 Setup PNEV512B measurement – antenna in air



Fig 14. MiniVNA connected to PNEV512B and PC via USB

As a first step connect the MiniVNA to the PNEV512B at the measurement points shown in Fig 13.

As a next step you measure the antenna return loss with the MiniVNA.

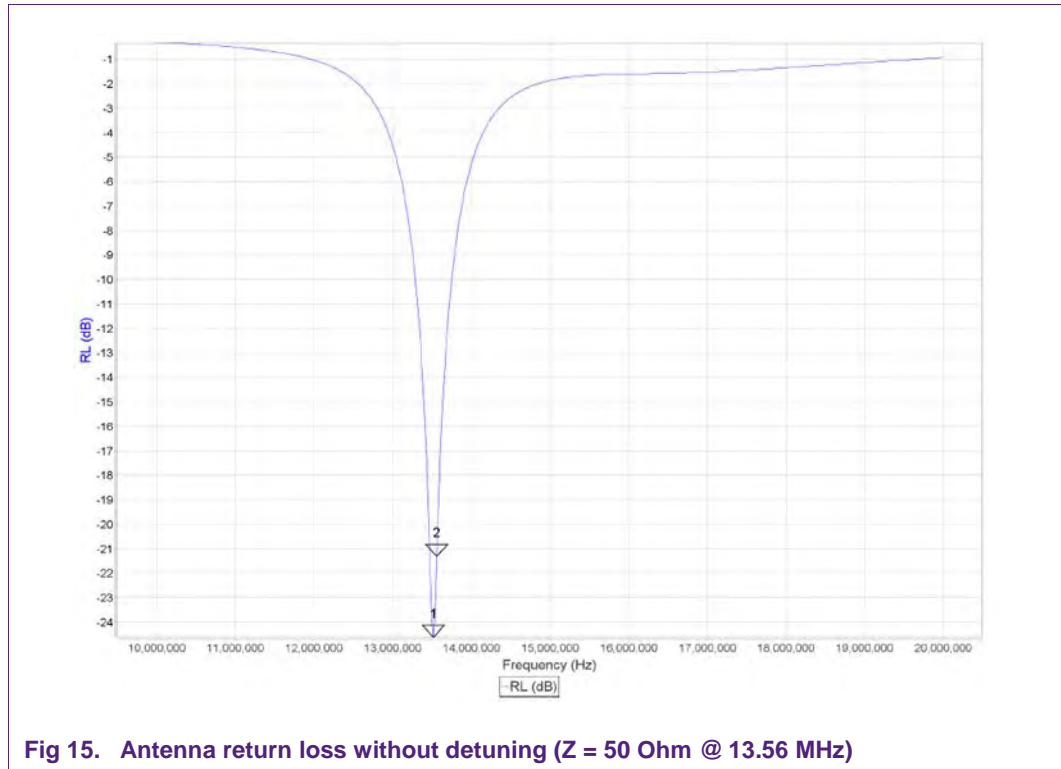

Fig 15. Antenna return loss without detuning ( $Z = 50 \text{ Ohm}$  @ 13.56 MHz)

Table 4. Return loss and Z values (antenna correctly tuned)

Marker	Frequency [Hz]	RL [dB]	RP [°]	TL [dB]	TP [°]	SWR	Z	R <sub>S</sub>	X <sub>S</sub>
1	13.517.150	-24,62	84,78	0,00	0,00	1,12	50,5	50,2	5,9
2	13.560.438	-21,30	34,19	0,00	0,00	1,19	57,6	57,4	5,6
1 – 2	43.288	3,32	50,60	0,00	0,00	---	7,1	7,2	0,3



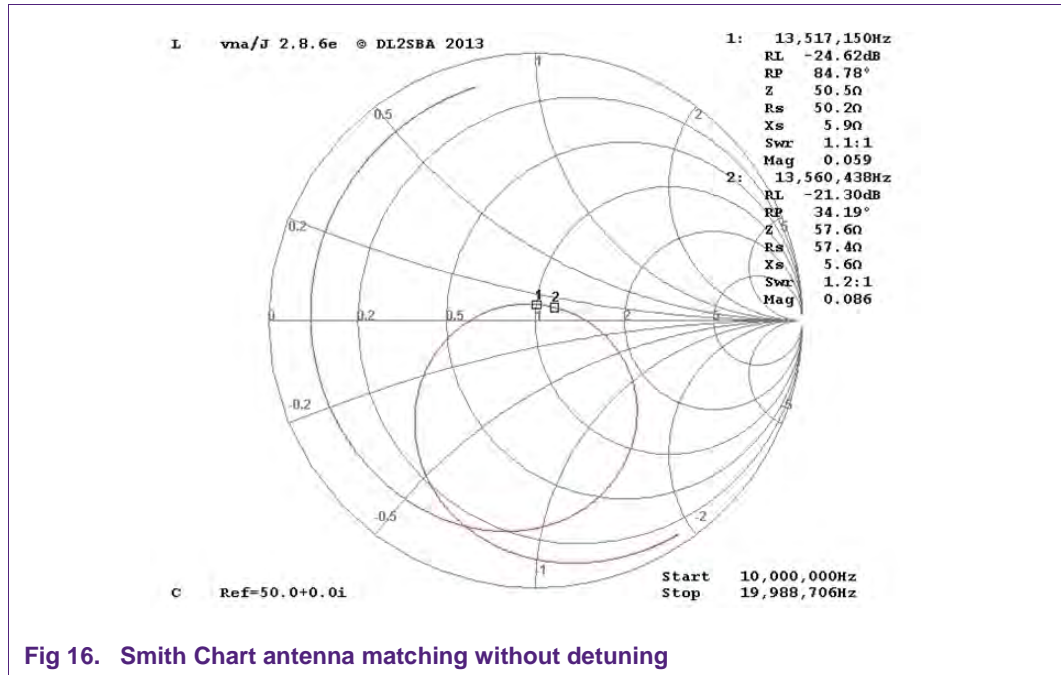

Fig 16. Smith Chart antenna matching without detuning

## 5.2 Recommended tuning for PN512 transceiver

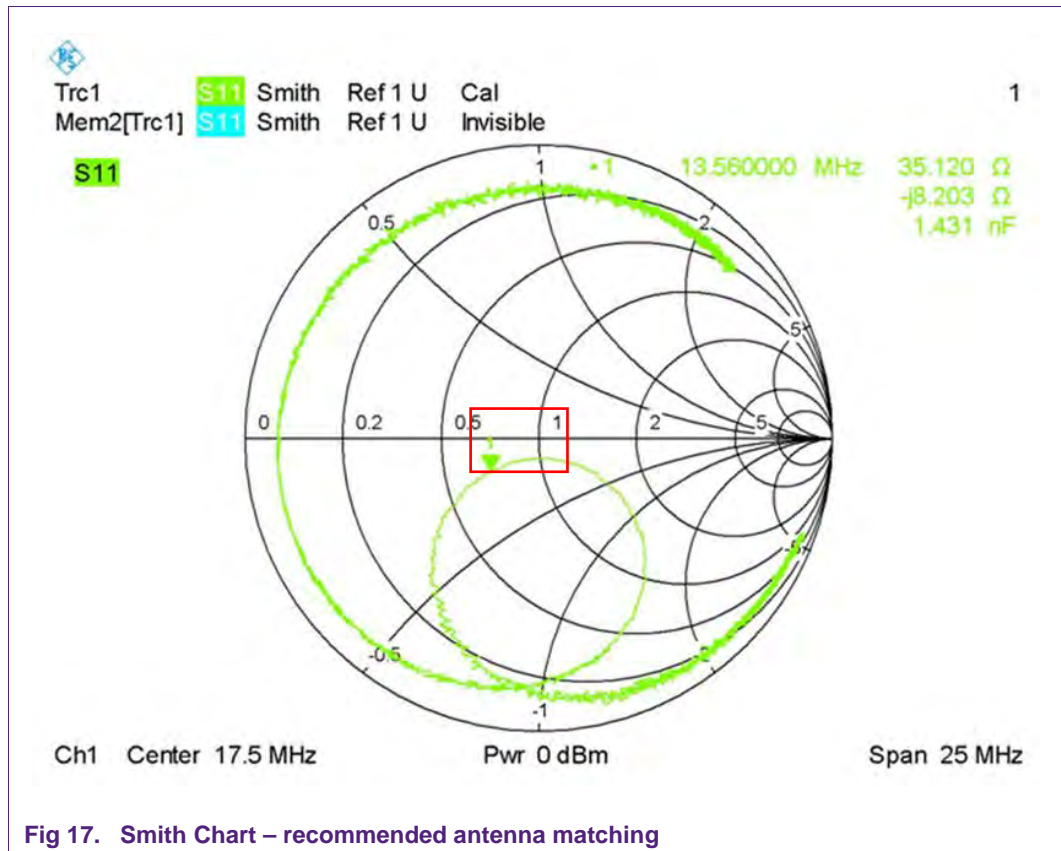

Fig 17. Smith Chart – recommended antenna matching

The area in the red rectangle (Fig 17) shows the recommended impedance range.

It is across the real axis (the impedance is real) and the best Z value is around 40 Ohm. Do not go below 35 Ohm in order to avoid device current limitation (IDD(TVDD)) as specified in the transceiver [datasheet](#). If performance is not a problem also higher Z tuning can be considered.

**Important note:**

- a) NFC Forum compliant transceiver like PN512 device operates in card and reader mode and a tradeoff for the optimal Z matching must be evaluated.
- b) In order to be compliant to NFC standard specification the orientation (angle) of the Z circle is important (see Fig 17)

## 6. Antenna Detuning

This chapter will explain how the Smith chart of a detuned antenna looks like and which steps must be done to tune such an antenna.

### 6.1 Detuned antenna setup

To achieve a detuned antenna setup, a metal surface is placed close to the antenna of the PNEV512B (see Fig 18).

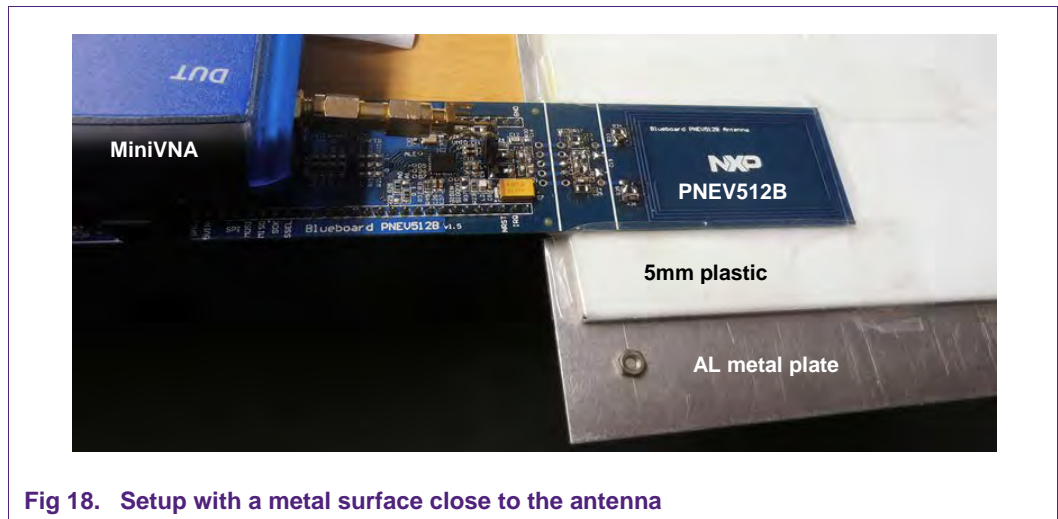

Fig 18. Setup with a metal surface close to the antenna

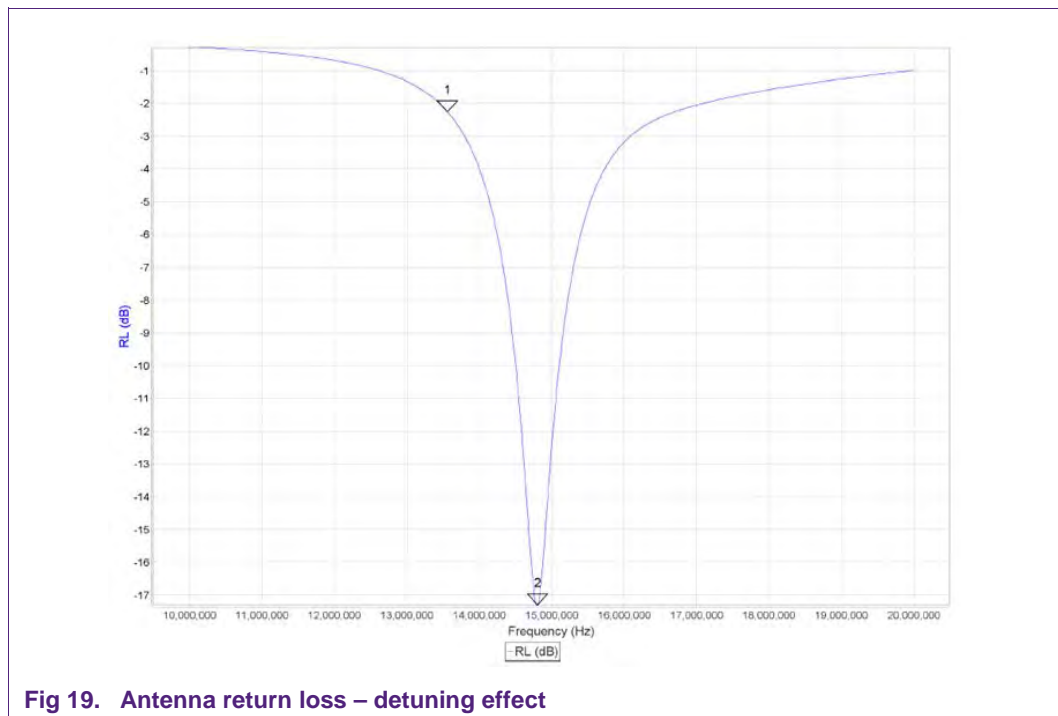
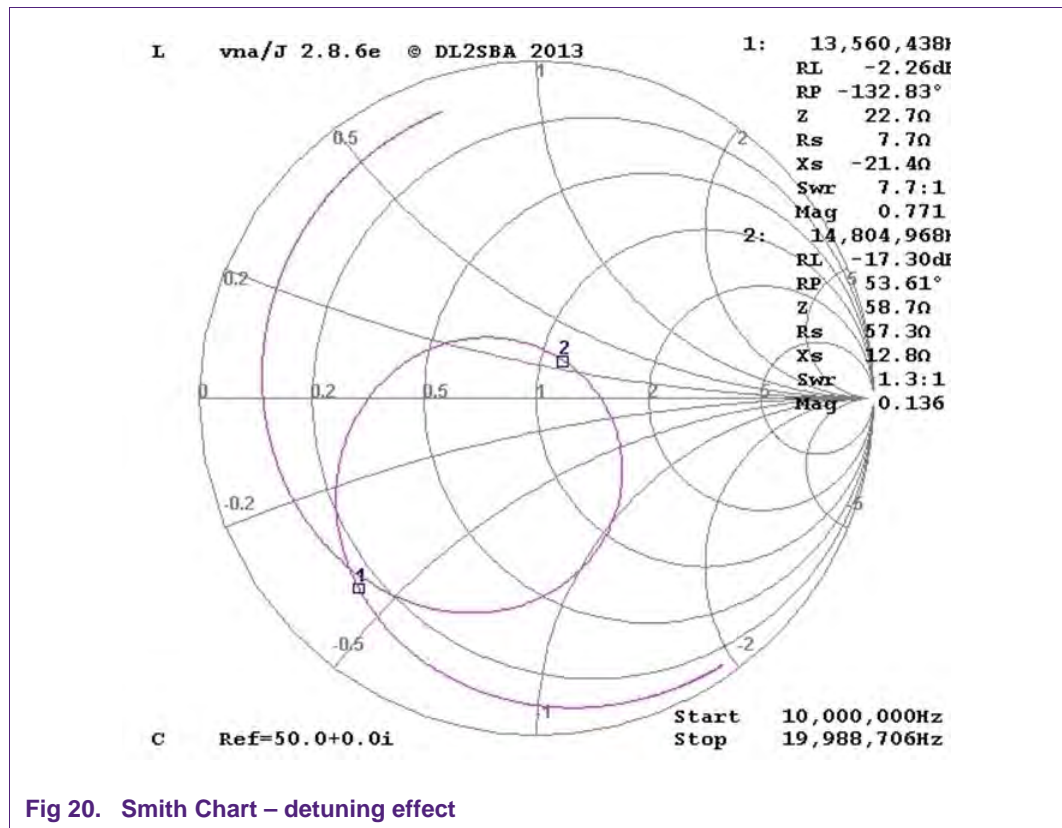

Fig 19. Antenna return loss – detuning effect

**Table 5. Return loss and Z values (antenna detuned)**

Marker	Frequency [Hz]	RL [dB]	RP [°]	TL [dB]	TP [°]	SWR	Z	R <sub>s</sub>	X <sub>s</sub>
1	13.560.438	-2,26	-123,83	0,00	0,00	7,74	22,7	7,7	-21,4
2	14.804.968	-17,30	53,61	0,00	0,00	1,32	58,7	57,3	12,8
1-2	1.244.530	15,04	186,44	0,00	0,00	---	36,00	49,6	34,2

The measurement of the detuned antenna shows, that the minimum return loss RL shifted up to 14.8 MHz. These results indicate that the antenna has less inductance (eddy current on the metal plate); the antenna matching can be compensated by increasing the values of C<sub>1</sub> and C<sub>2</sub>.



The Smith Chart shows, that the antenna is not correctly matched. At 13.56 MHz the antenna has an impedance  $Z = 7,7 - j21$  (marker 1).

## 6.2 Tuning adjustment steps and measurement

Based on the setup and measurement results from section 6.1, this chapter will explain which changes must be done to get a well-tuned antenna setup.

Some general considerations:

1. Increasing capacitor  $C_1$  (series) – will make the Z circle bigger and will shift down the resonance frequency
2. Increasing capacitor  $C_2$  (parallel) – will reduce the resonance frequency and will make the Z circle smaller.

### 6.2.1 Tuning of the detuned PNEV512B

The same setup with the metal plate (Fig 18) will be used and the following steps must be done to adjust the matching of the detuned antenna.

#### Step 1:

- Increase the overall value of  $C_2$  to adjust a lower resonance frequency
- Change  $C_2$  from  $(100 + 47)\text{pF}$  to  $(100 + 68)\text{pF}$

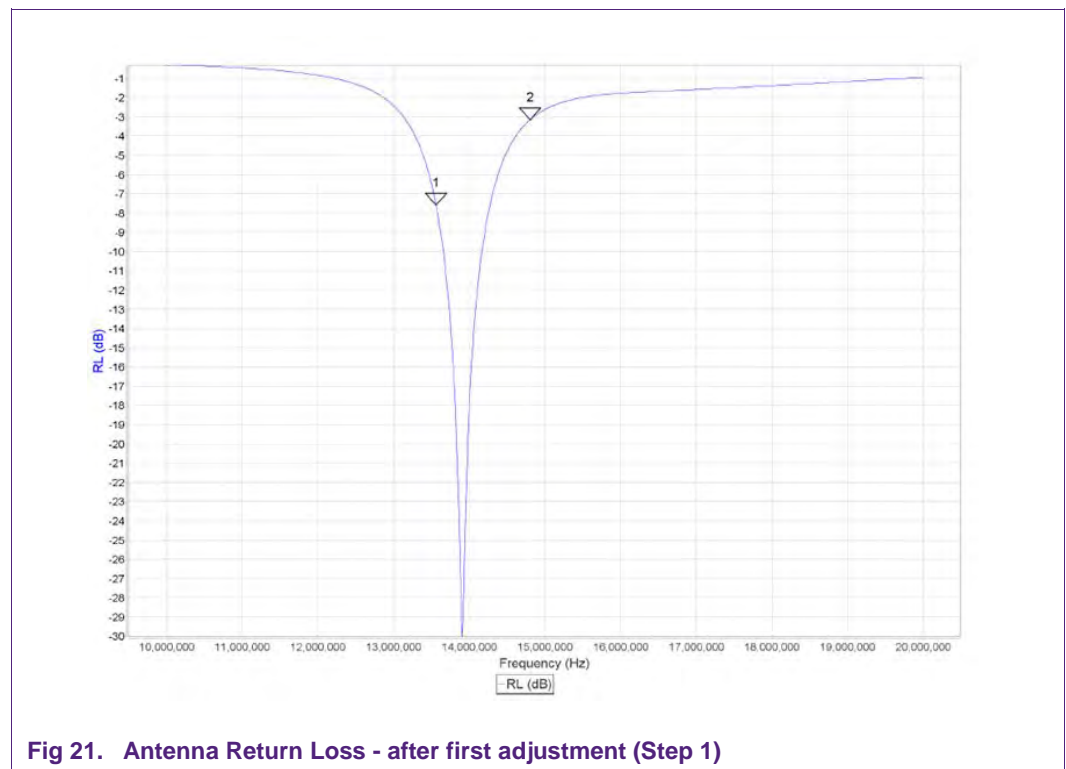

**Table 6. Return loss and Z values - after first adjustment (Step 1)**

Marker	Frequency [Hz]	RL [dB]	RP [°]	TL [dB]	TP [°]	SWR	Z	$R_s$	$X_s$
1	13.560.438	-7,58	-153,98	0,00	0,00	2,44	23,4	21,4	-9,5
2	14.804.968	-3,15	-85,80	0,00	0,00	5,58	53,6	18,6	-50,2
1 – 2	1.244.530	4,43	68,18	0,00	0,00	---	30,1	2,8	40,7

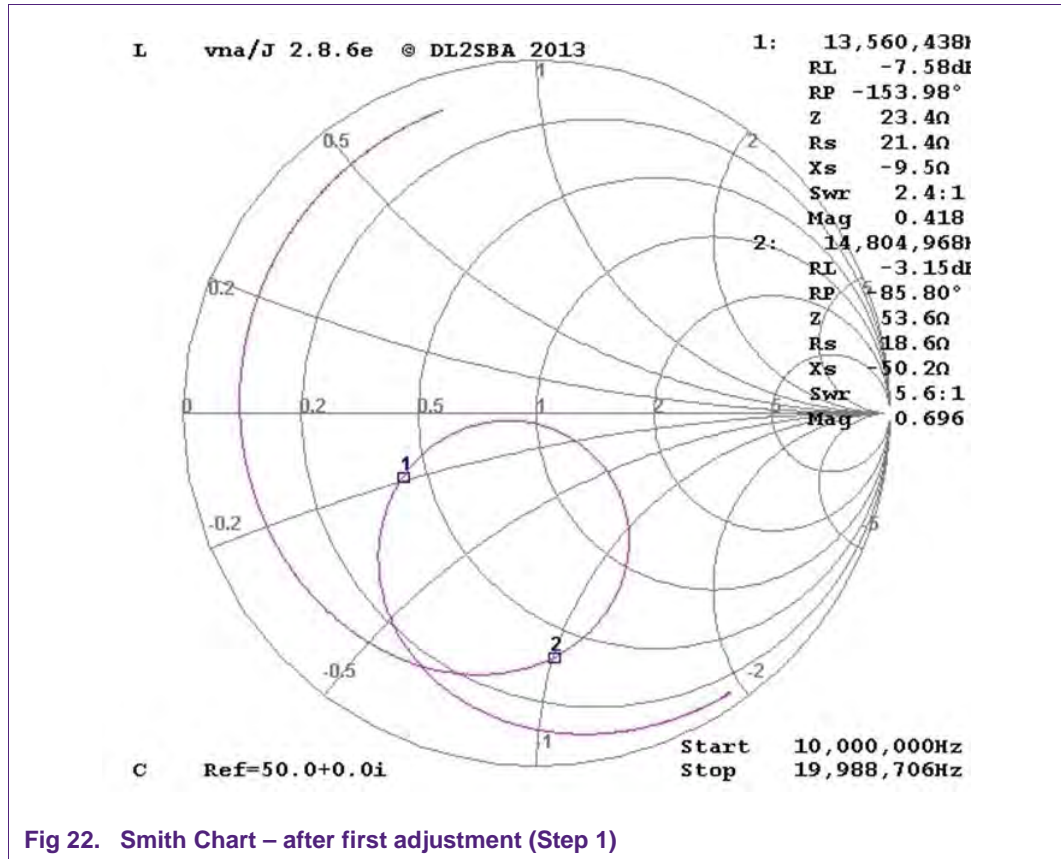

Fig 22. Smith Chart – after first adjustment (Step 1)

The Smith Chart shows, that the increased  $C_2$  made some changes, at 13,56 MHz the antenna has now an impedance  $Z = 21,1 - j9,5$  (marker 1).

The effect of increasing of  $C_2$  was mainly a shrinking of the Z Smith Chart circle and decreasing of the resonance frequency.

**Step 2:**

- Increase the overall value of  $C_1$  to adjust Z circle radius (the capacitor increase will increase the radius; the capacitor decrease will decrease the radius) and fine tune the resonance frequency.
- Change  $C_1$  from 33 pF to (33 + 6,8)pF

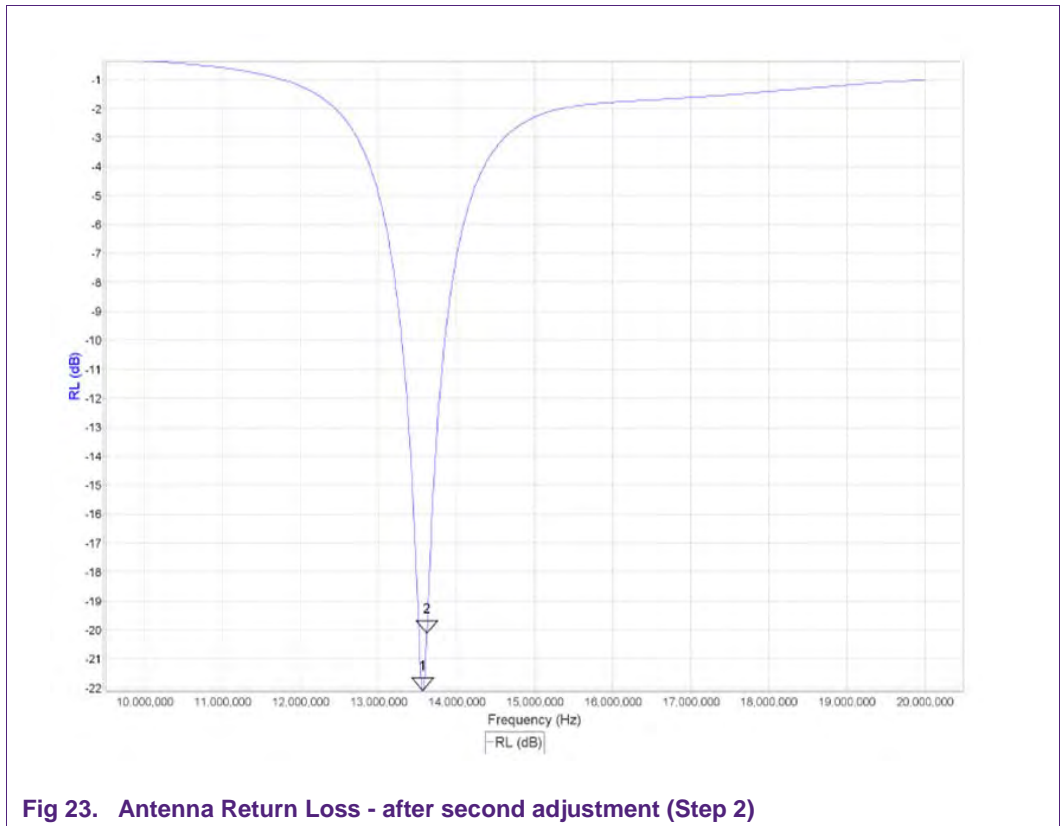

**Table 7. Return loss and Z values - after second adjustment (Step 2)**

Marker	Frequency [Hz]	RL [dB]	RP [°]	TL [dB]	TP [°]	SWR	Z	$R_s$	$X_s$
1	13.560.438	-22,10	86,97	0,00	0,00	1,17	50,4	49,8	7,9
2	13.614.548	-20,11	41,77	0,00	0,00	1,22	57,9	57,4	7,6
1 – 2	54.110	1,98	45,20	0,00	0,00	---	7,5	7,6	0,2

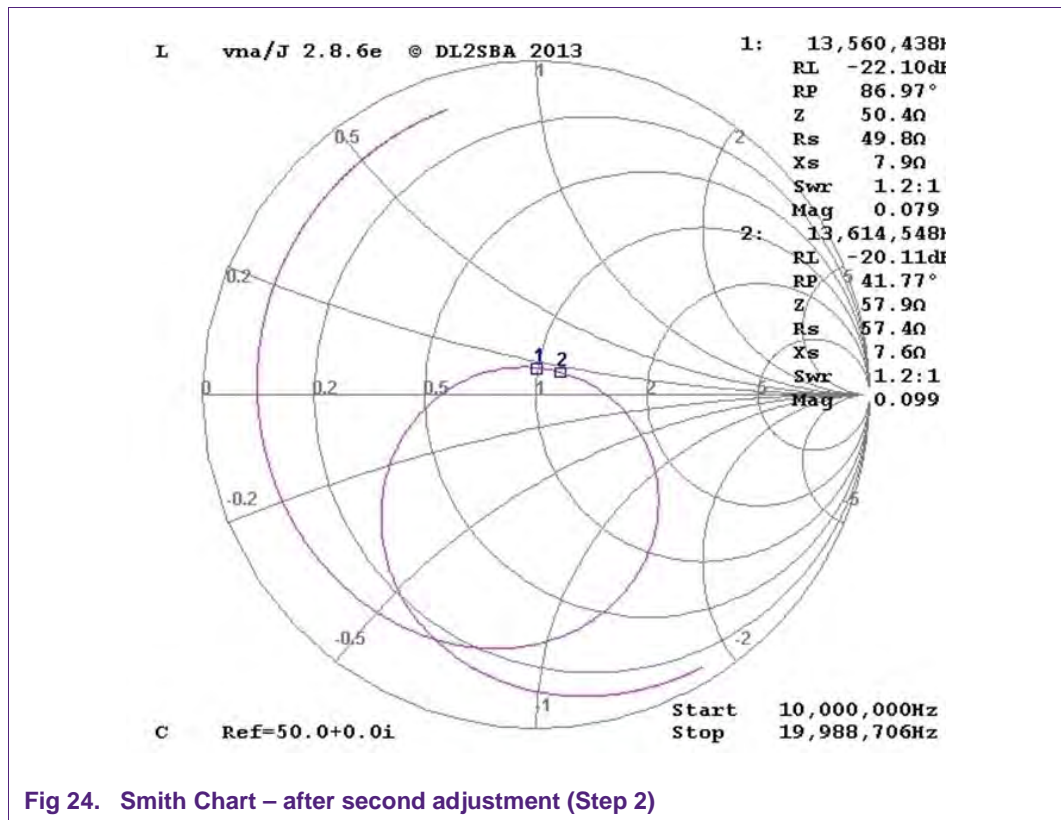

Fig 24. Smith Chart – after second adjustment (Step 2)

The Smith Chart shows, that the increased  $C_1$  made some changes, at 13.56 MHz the antenna has now an impedance  $Z = 49,8 - j7,9$  (marker 1).

The effect of increasing of  $C_1$  was mainly an enlargement of the Z Smith Chart circle and decreasing of the resonance frequency.

Now the antenna is well tuned →

**Result: Antenna correctly matched to 50 Ohm @ 13.56 MHz (see section 4.4)**



## 7. Reference documents

---

### 7.1 Datasheets

NXP provides the following datasheets:

- PN512; PN512 Full NFC Forum compliant solution;  
[http://www.nxp.com/documents/data\\_sheet/PN512.pdf](http://www.nxp.com/documents/data_sheet/PN512.pdf)
- CLRC663; CLRC663 High performance NFC reader solution;  
[http://www.nxp.com/documents/data\\_sheet/CLRC663.pdf](http://www.nxp.com/documents/data_sheet/CLRC663.pdf)

### 7.2 Application notes

NXP provides the following application notes:

- AN11308; Quick Start Up Guide PNEV512B;  
[http://www.nxp.com/documents/application\\_note/AN11308.pdf](http://www.nxp.com/documents/application_note/AN11308.pdf)
- AN11019; CLRC663, MFRC630, MFRC631, SLRC610 Antenna Design Guide;  
[http://www.nxp.com/documents/application\\_note/AN11019.pdf](http://www.nxp.com/documents/application_note/AN11019.pdf)
- AN1445; Antenna design guide for MFRC52x, PN51x, PN53x  
[http://www.nxp.com/documents/application\\_note/AN1445\\_An1444.zip](http://www.nxp.com/documents/application_note/AN1445_An1444.zip)

### 7.3 General purpose simulation tool RFSIM99

In order to get familiarity with antenna tuning effects with matching network variation, NXP recommends this freeware RF simulation tool.

<http://www.nxp.com/redirect/electroschematics.com/wp-content/uploads/2008/12/rf-sim-99.zip>

It can be downloaded and installed on any Windows PC's and it is straightforward. Some RFSIM99 examples are provided during NXP Mass Market and Identification trainings as supplement software resource to improve customers' RFID antenna design knowhow.

## 8. Legal information

### 8.1 Definitions

**Draft** — The document is a draft version only. The content is still under internal review and subject to formal approval, which may result in modifications or additions. NXP Semiconductors does not give any representations or warranties as to the accuracy or completeness of information included herein and shall have no liability for the consequences of use of such information.

### 8.2 Disclaimers

**Limited warranty and liability** — Information in this document is believed to be accurate and reliable. However, NXP Semiconductors does not give any representations or warranties, expressed or implied, as to the accuracy or completeness of such information and shall have no liability for the consequences of use of such information.

In no event shall NXP Semiconductors be liable for any indirect, incidental, punitive, special or consequential damages (including - without limitation - lost profits, lost savings, business interruption, costs related to the removal or replacement of any products or rework charges) whether or not such damages are based on tort (including negligence), warranty, breach of contract or any other legal theory.

Notwithstanding any damages that customer might incur for any reason whatsoever, NXP Semiconductors' aggregate and cumulative liability towards customer for the products described herein shall be limited in accordance with the Terms and conditions of commercial sale of NXP Semiconductors.

**Right to make changes** — NXP Semiconductors reserves the right to make changes to information published in this document, including without limitation specifications and product descriptions, at any time and without notice. This document supersedes and replaces all information supplied prior to the publication hereof.

**Suitability for use** — NXP Semiconductors products are not designed, authorized or warranted to be suitable for use in life support, life-critical or safety-critical systems or equipment, nor in applications where failure or malfunction of an NXP Semiconductors product can reasonably be expected to result in personal injury, death or severe property or environmental damage. NXP Semiconductors accepts no liability for inclusion and/or use of NXP Semiconductors products in such equipment or applications and therefore such inclusion and/or use is at the customer's own risk.

**Applications** — Applications that are described herein for any of these products are for illustrative purposes only. NXP Semiconductors makes no representation or warranty that such applications will be suitable for the specified use without further testing or modification.

Customers are responsible for the design and operation of their applications and products using NXP Semiconductors products, and NXP Semiconductors accepts no liability for any assistance with applications or customer product design. It is customer's sole responsibility to determine whether the NXP Semiconductors product is suitable and fit for the customer's applications and products planned, as well as for the planned application and use of customer's third party customer(s). Customers should provide appropriate design and operating safeguards to minimize the risks associated with their applications and products.

NXP Semiconductors does not accept any liability related to any default, damage, costs or problem which is based on any weakness or default in the customer's applications or products, or the application or use by customer's third party customer(s). Customer is responsible for doing all necessary testing for the customer's applications and products using NXP Semiconductors products in order to avoid a default of the applications and the products or of the application or use by customer's third party customer(s). NXP does not accept any liability in this respect.

**Export control** — This document as well as the item(s) described herein may be subject to export control regulations. Export might require a prior authorization from competent authorities.

**Evaluation products** — This product is provided on an "as is" and "with all faults" basis for evaluation purposes only. NXP Semiconductors, its affiliates and their suppliers expressly disclaim all warranties, whether express, implied or statutory, including but not limited to the implied warranties of non-infringement, merchantability and fitness for a particular purpose. The entire risk as to the quality, or arising out of the use or performance, of this product remains with customer.

In no event shall NXP Semiconductors, its affiliates or their suppliers be liable to customer for any special, indirect, consequential, punitive or incidental damages (including without limitation damages for loss of business, business interruption, loss of use, loss of data or information, and the like) arising out of the use of or inability to use the product, whether or not based on tort (including negligence), strict liability, breach of contract, breach of warranty or any other theory, even if advised of the possibility of such damages.

Notwithstanding any damages that customer might incur for any reason whatsoever (including without limitation, all damages referenced above and all direct or general damages), the entire liability of NXP Semiconductors, its affiliates and their suppliers and customer's exclusive remedy for all of the foregoing shall be limited to actual damages incurred by customer based on reasonable reliance up to the greater of the amount actually paid by customer for the product or five dollars (US\$5.00). The foregoing limitations, exclusions and disclaimers shall apply to the maximum extent permitted by applicable law, even if any remedy fails of its essential purpose.

### 8.3 Licenses

#### Purchase of NXP ICs with NFC technology

Purchase of an NXP Semiconductors IC that complies with one of the Near Field Communication (NFC) standards ISO/IEC 18092 and ISO/IEC 21481 does not convey an implied license under any patent right infringed by implementation of any of those standards.

### 8.4 Trademarks

Notice: All referenced brands, product names, service names and trademarks are property of their respective owners.

9. List of figures

Fig 1. Agilent PNA-L Network Analyzer .....4

Fig 2. MiniVNA PRO PC Based Network Analyzer .....5

Fig 3. Driver selection and test .....6

Fig 4. Create a Calibration .....6

Fig 5. Calibration Window .....7

Fig 6. Calibration kit .....7

Fig 7. Smith Chart normalized to 50 Ohm .....8

Fig 8. Antenna equivalent circuit .....10

Fig 9. Antenna tuning schematic .....12

Fig 10. PNEV512B Antenna PCB .....13

Fig 11.  $X_s$  measured @ MiniVNA .....13

Fig 12.  $X_s$  measured with MiniVNA – marker @ SRF. 14

Fig 13. PNEV512B .....15

Fig 14. MiniVNA connected to PNEV512B and PC via USB .....15

Fig 15. Antenna return loss without detuning ( $Z = 50$  Ohm @ 13.56 MHz) .....16

Fig 16. Smith Chart antenna matching without detuning .....17

Fig 17. Smith Chart – recommended antenna matching .....17

Fig 18. Setup with a metal surface close to the antenna .....19

Fig 19. Antenna return loss – detuning effect .....19

Fig 20. Smith Chart – detuning effect .....20

Fig 21. Antenna Return Loss - after first adjustment (Step 1) .....21

Fig 22. Smith Chart – after first adjustment (Step 1) ...22

Fig 23. Antenna Return Loss - after second adjustment (Step 2) .....23

Fig 24. Smith Chart – after second adjustment (Step 2) .....24

10. List of tables

Table 1. Return loss conversion table.....9  
Table 2.  $R_s, X_s$  - measured antenna values ..... 13  
Table 3.  $R_s, X_s$  - measured antenna values ..... 14  
Table 4. Return loss and Z values (antenna correctly tuned)..... 16  
Table 5. Return loss and Z values (antenna detuned)..20  
Table 6. Return loss and Z values - after first adjustment (Step 1) .....21  
Table 7. Return loss and Z values - after second adjustment (Step 2).....23

## 11. Contents

---

<b>1.</b>	<b>Introduction .....</b>	<b>3</b>
1.1	Scope .....	3
1.2	What you need .....	3
<b>2.</b>	<b>Network Analyzer .....</b>	<b>4</b>
2.1	Network Analyzer – General .....	4
2.2	Mini VNA .....	5
2.2.1	Mini VNA Driver test and calibration for S11 measurement .....	6
<b>3.</b>	<b>Smith Chart .....</b>	<b>8</b>
3.1	Smith Chart – General .....	8
3.2	Smith Chart S11 Parameter .....	9
<b>4.</b>	<b>HF Antenna Basics.....</b>	<b>10</b>
4.1	HF RFID Loop Antenna.....	10
4.1.1	Measurement and calculation of equivalent parameters .....	10
4.2	Antenna Q Factor.....	10
4.3	NXP Recommended Matching Network: Directly matched antenna .....	12
4.4	PNEV512B Antenna measurement example ...	13
<b>5.</b>	<b>Matching Example – based on the PNEV512B15</b>	
5.1	Setup PNEV512B measurement – antenna in air .....	15
5.2	Recommended tuning for PN512 transceiver...	17
<b>6.</b>	<b>Antenna Detuning .....</b>	<b>19</b>
6.1	Detuned antenna setup.....	19
6.2	Tuning adjustment steps and measurement ....	21
6.2.1	Tuning of the detuned PNEV512B .....	21
<b>7.</b>	<b>Reference documents.....</b>	<b>25</b>
7.1	Datasheets .....	25
7.2	Application notes.....	25
7.3	General purpose simulation tool RFSIM99 .....	25
<b>8.</b>	<b>Legal information .....</b>	<b>26</b>
8.1	Definitions .....	26
8.2	Disclaimers.....	26
8.3	Licenses.....	26
8.4	Trademarks.....	26
<b>9.</b>	<b>List of figures.....</b>	<b>27</b>
<b>10.</b>	<b>List of tables .....</b>	<b>28</b>
<b>11.</b>	<b>Contents.....</b>	<b>29</b>

---

Please be aware that important notices concerning this document and the product(s) described herein, have been included in the section 'Legal information'.

---