

---

# HM62864 Series

65536-word  $\times$  8-bit High Speed CMOS Static RAM

# HITACHI

ADE-203-255B (Z)

Rev. 2.0

Jul. 4, 1995

---

## Description

The Hitachi HM62864 is a CMOS static RAM organized 64-kword  $\times$  8-bit. It realizes higher density, higher performance and low power consumption by employing 0.8  $\mu$ m Hi-CMOS process technology. It offers low power standby power dissipation; therefore, it is suitable for battery backup systems. The device, packaged in a 525-mil SOP (460-mil body SOP) and a 8  $\times$  20 mm TSOP with thickness of 1.2 mm, is available for high density mounting. TSOP package is suitable for cards.

## Features

- High speed
  - Fast access time: 55/70/85 ns (max)
- Low power
  - Active: 50 mW (typ) (f = 1 MHz)
  - Standby: 2  $\mu$ W (typ)
- Single 5 V supply
- Completely static memory
  - No clock or timing strobe required
- Equal access and cycle times
- Common data input and output
  - Three state output
- Directly TTL compatible
  - All inputs and outputs
- Capability of battery backup operation
  - 2 chip selection for battery backup

---

## HM62864 Series

---

### Ordering Information

Type No.	Access Time	Package
HM62864LFP-7	70 ns	525-mil 32-pin plastic SOP (FP-32D)
HM62864LFP-8	85 ns	
HM62864LFP-5SL	55 ns	8 mm × 20 mm 32-pin TSOP (normal type) (TFP-32D)
HM62864LFP-7SL	70 ns	
HM62864LFP-8SL	85 ns	
HM62864LT-7	70 ns	8 mm × 20 mm 32-pin TSOP (normal type) (TFP-32D)
HM62864LT-8	85 ns	
HM62864LT-5SL	55 ns	8 mm × 20 mm 32-pin TSOP (normal type) (TFP-32D)
HM62864LT-7SL	70 ns	
HM62864LT-8SL	85 ns	

---

## Pin Arrangement

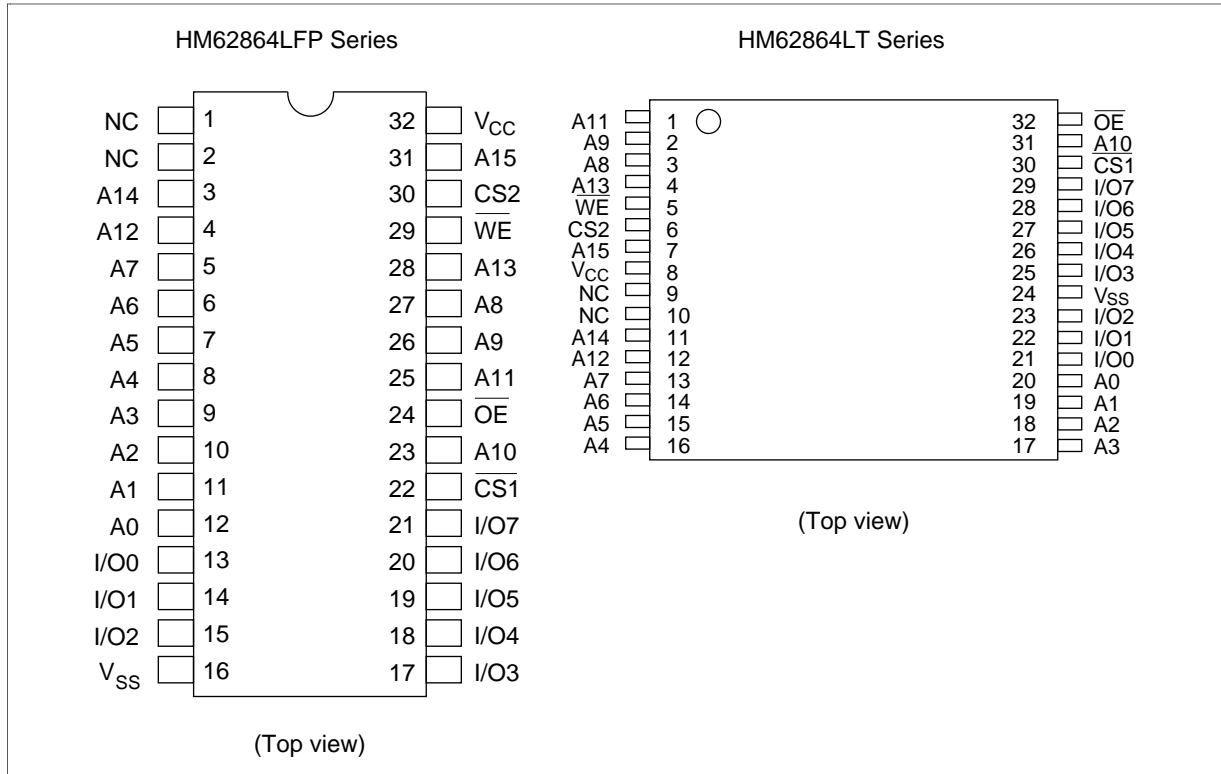

## Pin Description

Pin Name	Function
A0 to A15	Address
I/O0 to I/O7	Input/output
CS1	Chip select 1
CS2	Chip select 2
WE	Write enable
OE	Output enable
NC	No connection
V <sub>CC</sub>	Power supply
V <sub>SS</sub>	Ground

# HM62864 Series

## Block Diagram

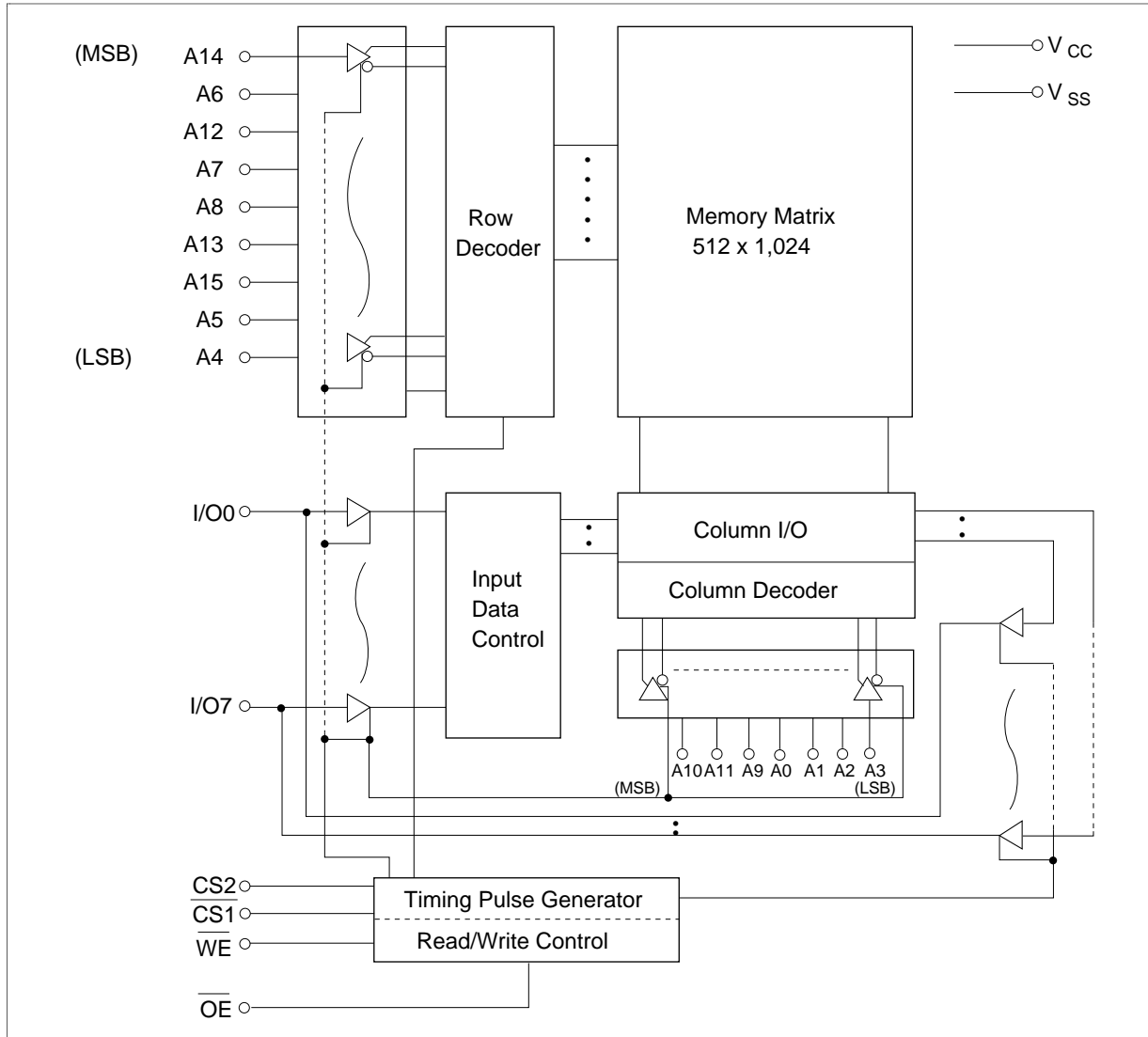

**Function Table**

$\overline{\text{CS1}}$	CS2	$\overline{\text{OE}}$	$\overline{\text{WE}}$	Mode	$V_{\text{CC}}$ Current	I/O Pin	Ref. Cycle
H	X	X	X	Not selected	$I_{\text{SB}}, I_{\text{SB1}}$	High-Z	—
X	L	X	X	Not selected	$I_{\text{SB}}, I_{\text{SB1}}$	High-Z	—
L	H	H	H	Output disable	$I_{\text{CC}}$	High-Z	—
L	H	L	H	Read	$I_{\text{CC}}$	Dout	Read cycle (1) to (3)
L	H	H	L	Write	$I_{\text{CC}}$	Din	Write cycle (1)
L	H	L	L	Write	$I_{\text{CC}}$	Din	Write cycle (2)

Note: X: High or Low

**Absolute Maximum Ratings**

Parameter	Symbol	Value	Unit
Power supply voltage <sup>1</sup>	$V_{\text{CC}}$	-0.5 to +7.0	V
Terminal voltage <sup>1</sup>	$V_{\text{T}}$	-0.5 <sup>2</sup> to $V_{\text{CC}} + 0.3$ <sup>3</sup>	V
Power dissipation	$P_{\text{T}}$	1.0	W
Operating temperature	Topr	0 to +70	°C
Storage temperature	Tstg	-55 to +125	°C
Storage temperature under bias	Tbias	-10 to +85	°C

- Notes: 1. Relative to  $V_{\text{SS}}$   
 2.  $V_{\text{T}}$  min: -3.0 V for pulse half-width  $\leq$  50 ns  
 3. Maximum voltage is 7.0V

**Recommended DC Operating Conditions (Ta = 0 to +70°C)**

Parameter	Symbol	Min	Typ	Max	Unit
Supply voltage	$V_{\text{CC}}$	4.5	5.0	5.5	V
	$V_{\text{SS}}$	0	0	0	V
Input high (logic 1) voltage	$V_{\text{IH}}$	2.2	—	$V_{\text{CC}} + 0.3$	V
Input low (logic 0) voltage	$V_{\text{IL}}$	-0.3 <sup>1</sup>	—	0.8	V

Note: 1.  $V_{\text{IL}}$  min: -3.0 V for pulse half-width  $\leq$  50 ns

## HM62864 Series

### DC Characteristics (Ta = 0 to +70°C, V<sub>CC</sub> = 5 V ±10%, V<sub>SS</sub> = 0 V)

Parameter	Symbol	Min	Typ <sup>1</sup>	Max	Unit	Test conditions	
Input leakage current	I <sub>LI</sub>	—	—	1	μA	V <sub>SS</sub> ≤ Vin ≤ V <sub>CC</sub>	
Output leakage current	I <sub>LO</sub>	—	—	1	μA	$\overline{CS1} = V_{IH}$ or $CS2 = V_{IL}$ or $\overline{OE} = V_{IH}$ or $\overline{WE} = V_{IL}$ , V <sub>SS</sub> ≤ V <sub>I/O</sub> ≤ V <sub>CC</sub>	
Operating power supply current	I <sub>CC</sub>	—	10	15	mA	$\overline{CS1} = V_{IL}$ , CS2 = V <sub>IH</sub> , Others = V <sub>IH</sub> /V <sub>IL</sub> , I <sub>I/O</sub> = 0 mA	
Average operating power supply current	HM62864-5	I <sub>CC1</sub>	—	55	70	mA	Min cycle, duty = 100%, $\overline{CS1} = V_{IL}$ , CS2 = V <sub>IH</sub> ,
	HM62864-7	I <sub>CC1</sub>	—	55	70		Others = V <sub>IH</sub> /V <sub>IL</sub> , I <sub>I/O</sub> = 0 mA
	HM62864-8	I <sub>CC1</sub>	—	45	60		
		I <sub>CC2</sub>	—	10	15	mA	Cycle time = 1 μs, duty = 100%, I <sub>I/O</sub> = 0 mA, $\overline{CS1} \leq V_{IL}$ , CS2 ≥ V <sub>IH</sub> , Others = V <sub>IH</sub> /V <sub>IL</sub> , V <sub>IH</sub> ≥ V <sub>CC</sub> - 0.2 V, 0 V ≤ V <sub>IL</sub> ≤ 0.2 V
Standby power supply current	I <sub>SB</sub>	—	0.7	3	mA	(1) or (2) (1) $\overline{CS1} = V_{IH}$ , CS2 = V <sub>IH</sub> (2) CS2 = V <sub>IL</sub>	
	I <sub>SB1</sub>	—	0.4	100	μA	0 V ≤ Vin ≤ V <sub>CC</sub> (1) or (2) (1) $\overline{CS1} \geq V_{CC} - 0.2 V$ ,	
	I <sub>SB1</sub>	—	0.4	50 <sup>2</sup>		CS2 ≥ V <sub>CC</sub> - 0.2V (2) 0 V ≤ CS2 ≤ 0.2 V	
Output low voltage	V <sub>OL</sub>	—	—	0.4	V	I <sub>OL</sub> = 2.1 mA	
Output high voltage	V <sub>OH</sub>	2.4	—	—	V	I <sub>OH</sub> = -1.0 mA	

Notes: 1. Typical values are at V<sub>CC</sub> = 5.0 V, Ta = +25°C and not guaranteed.

2. This characteristics is guaranteed only for SL version.

### Capacitance (Ta = 25°C, f = 1.0 MHz)<sup>\*1</sup>

Parameter	Symbol	Min	Typ	Max	Unit	Test Conditions
Input capacitance	C <sub>in</sub>	—	—	5	pF	Vin = 0 V
Input/output capacitance	C <sub>I/O</sub>	—	—	8	pF	V <sub>I/O</sub> = 0 V

Note: 1. This parameter is sampled and not 100% tested.

**AC Characteristics** ( $T_a = 0$  to  $+70^\circ\text{C}$ ,  $V_{CC} = 5\text{ V} \pm 10\%$ , unless otherwise noted.)

**Test Conditions**

- Input pulse levels: 0.8 V to 2.4 V
- Input rise and fall time: 5 ns
- Input and output timing reference levels: 1.5 V
- Output load: HM62864-5: 1 TTL + 30 pF (Including scope & jig)  
HM62864-7/8: 1 TTL + 100 pF (Including scope & jig)

**Read Cycle**

Parameter	Symbol	HM62864-5		HM62864-7		HM62864-8		Unit	Notes
		Min	Max	Min	Max	Min	Max		
Read cycle time	$t_{RC}$	55	—	70	—	85	—	ns	
Address access time	$t_{AA}$	—	55	—	70	—	85	ns	
Chip select access time	$\overline{CS1}$ $t_{CO1}$	—	55	—	70	—	85	ns	
	CS2 $t_{CO2}$	—	55	—	70	—	85	ns	
Output enable to output valid	$t_{OE}$	—	30	—	40	—	45	ns	
Chip selection to output in	$\overline{CS1}$ $t_{LZ1}$	5	—	10	—	10	—	ns	2
low-Z	CS2 $t_{LZ2}$	5	—	10	—	10	—	ns	2
Output enable to output in low-Z	$t_{OLZ}$	5	—	5	—	5	—	ns	2
Chip deselection in output in	$\overline{CS1}$ $t_{HZ1}$	0	20	0	25	0	30	ns	1, 2
high-Z	CS2 $t_{HZ2}$	0	20	0	25	0	30	ns	1, 2
Output disable to output in high-Z	$t_{OHZ}$	0	20	0	25	0	30	ns	1, 2
Output hold from address change	$t_{OH}$	5	—	10	—	10	—	ns	

Notes: 1.  $t_{HZ}$  and  $t_{OHZ}$  are defined as the time at which the outputs achieve the open circuit conditions and are not referred to output voltage levels.

2. This parameter is sampled and not 100% tested.

# HM62864 Series

Read Timing Waveform (1) ( $\overline{WE} = V_{IH}$ )

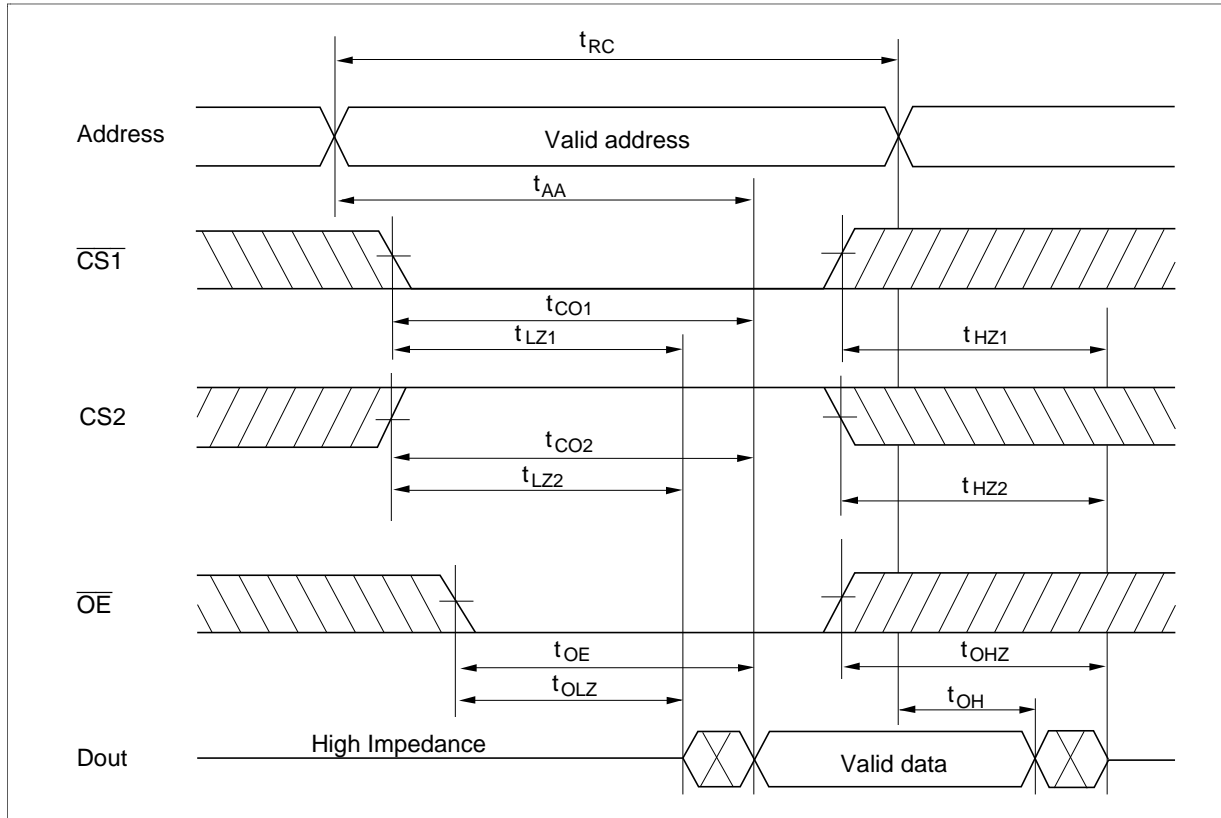



**Read Timing Waveform (2) ( $\overline{WE} = V_{IH}$ )**

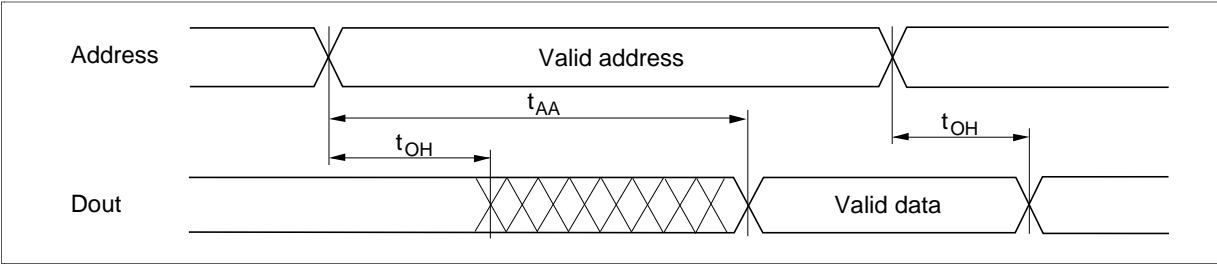

**Read Timing Waveform (3) ( $\overline{WE} = V_{IH}$ )**

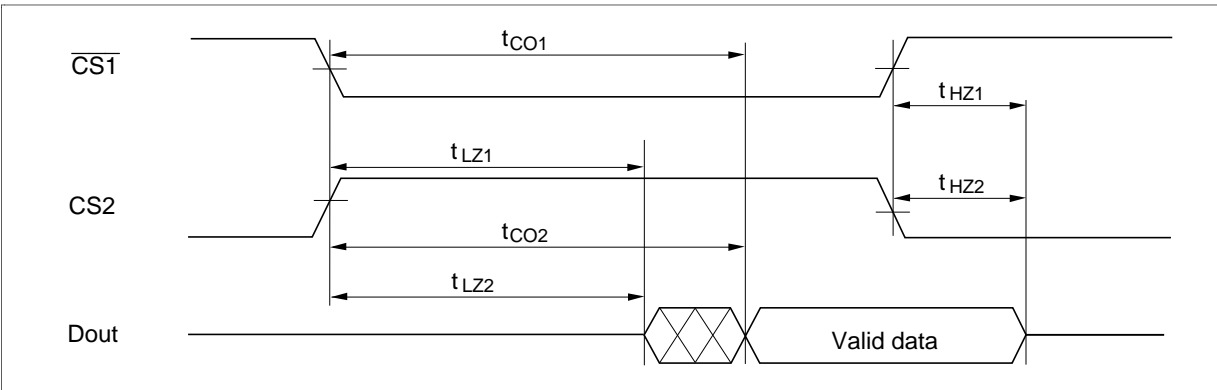

## HM62864 Series

### Write Cycle

Parameter	Symbol	HM62864-5		HM62864-7		HM62864-8		Unit	Notes
		Min	Max	Min	Max	Min	Max		
Write cycle time	$t_{WC}$	55	—	70	—	85	—	ns	
Chip selection to end of write	$t_{CW}$	50	—	60	—	75	—	ns	4
Address setup time	$t_{AS}$	0	—	0	—	0	—	ns	5
Address valid to end of write	$t_{AW}$	50	—	60	—	75	—	ns	
Write pulse width	$t_{WP}$	40	—	50	—	55	—	ns	3, 8
Write recovery time	$t_{WR}$	0	—	0	—	0	—	ns	6
Write to output in high-Z	$t_{WHZ}$	0	20	0	25	0	30	ns	1, 2, 7
Data to write time overlap	$t_{DW}$	30	—	30	—	35	—	ns	
Data hold from write time	$t_{DH}$	0	—	0	—	0	—	ns	
Output active from end of write	$t_{OW}$	5	—	5	—	5	—	ns	2
Output disable to output in high-Z	$t_{OHZ}$	0	20	0	25	0	30	ns	1, 2, 7

- Notes:
- $t_{WHZ}$  and  $t_{OHZ}$  are defined as the time at which the outputs achieve the open circuit conditions and are not referred to output voltage levels.
  - This parameter is sampled and not 100% tested.
  - A write occurs during the overlap of a low  $\overline{CS1}$ , a high CS2 and a low  $\overline{WE}$ . A write begins at the latest transition among  $\overline{CS1}$  going low, CS2 going high, and  $\overline{WE}$  going low. A write ends at the earliest transition among  $\overline{CS1}$  going high, CS2 going low, and  $\overline{WE}$  going high.  $t_{WP}$  is measured from the beginning of write to the end of write.
  - $t_{CW}$  is measured from the later of  $\overline{CS1}$  going low or CS2 going high to the end of write.
  - $t_{AS}$  is measured from the address valid to the beginning of write.
  - $t_{WR}$  is measured from the earliest of  $\overline{CS1}$  or  $\overline{WE}$  going high or CS2 going low to the end of write cycle.
  - During this period, I/O pin are in the output state; therefore, the input signals of the opposite phase to the outputs must not be applied.
  - In the write cycle with  $\overline{OE}$  low fixed,  $t_{WP}$  must satisfy the following equation to avoid a problem of data bus contention,  $t_{WP} \geq t_{WHZ} \max + t_{DW} \min$ .

Write Timing Waveform (1) ( $\overline{\text{OE}}$  Clock)

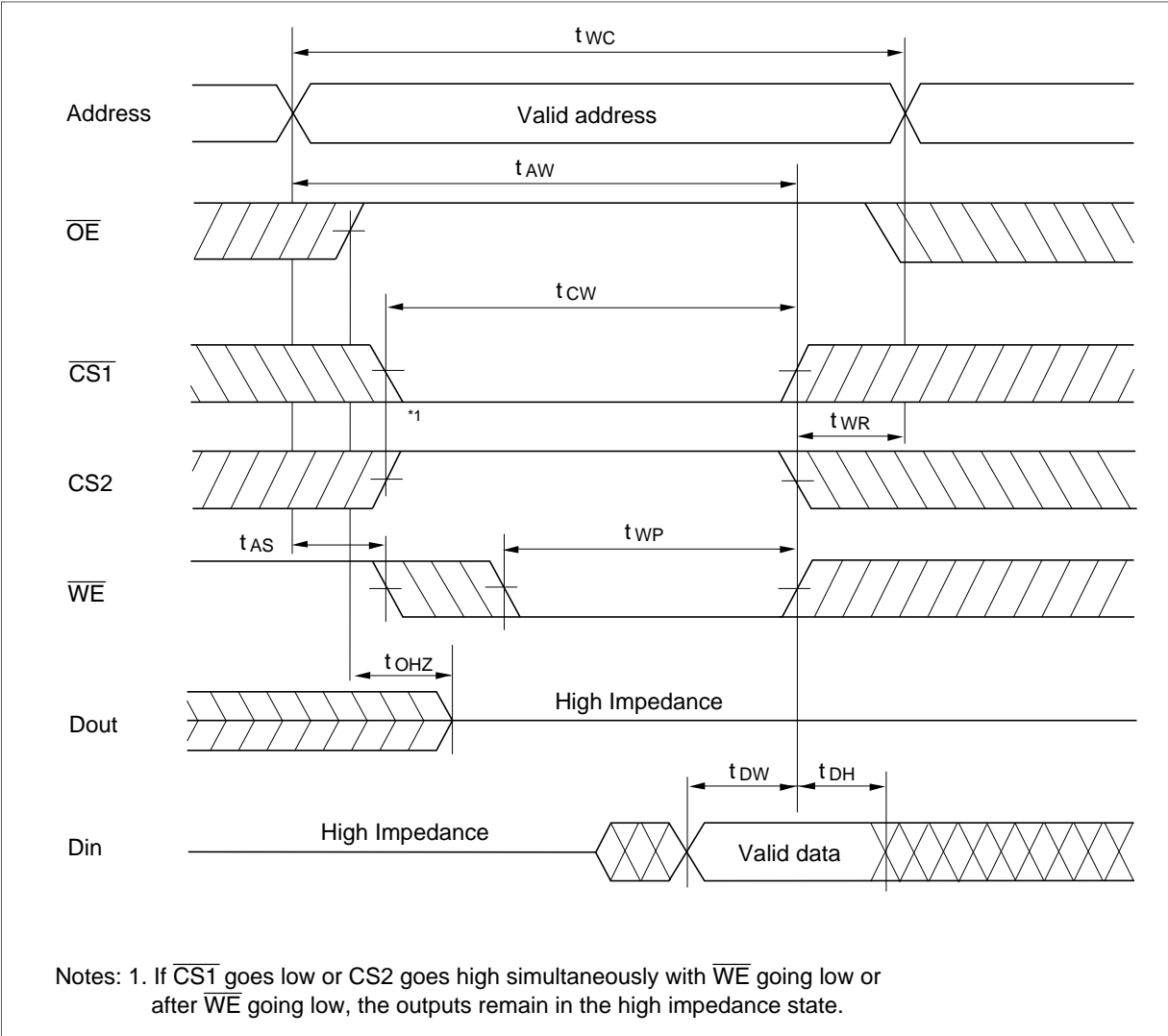

## HM62864 Series

### Write Timing Waveform (2) ( $\overline{\text{OE}}$ Low Fixed)

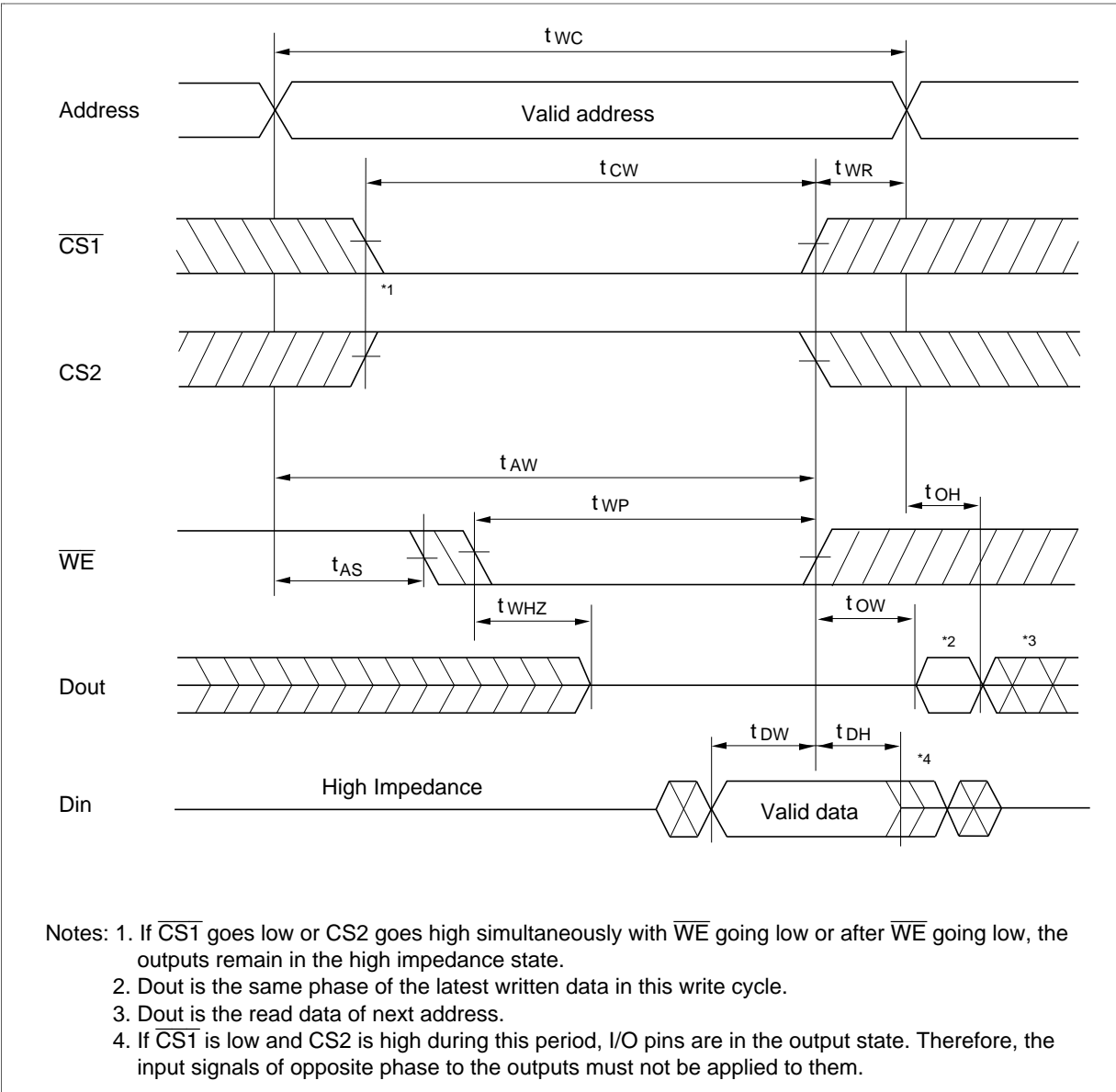

**Low  $V_{CC}$  Data Retention Characteristics ( $T_a = 0$  to  $+70^\circ\text{C}$ )**

This characteristics is guaranteed only for L-version.

Parameter	Symbol	Min	Typ <sup>1</sup>	Max	Unit	Test conditions <sup>5</sup>
$V_{CC}$ for data retention	$V_{DR}$	2.0	—	5.5	V	$0\text{ V} \leq V_{in} \leq V_{CC}$ , (1) or (2) (1) $\overline{CS1} \geq V_{CC} - 0.2\text{ V}$ , $CS2 \geq V_{CC} - 0.2\text{ V}$ (2) $0\text{ V} \leq CS2 \leq 0.2\text{ V}$
Data retention current	$I_{CCDR}$	—	0.1	$30^{+2}$	$\mu\text{A}$	$V_{CC} = 3.0\text{ V}$ , $0\text{ V} \leq V_{in} \leq V_{CC}$ , (1) or (2) (1) $\overline{CS1} \geq V_{CC} - 0.2\text{ V}$ , $CS2 \geq V_{CC} - 0.2\text{ V}$ (2) $0\text{ V} \leq CS2 \leq 0.2\text{ V}$
	$I_{CCDR}$	—	0.1	$10^{+3}$	$\mu\text{A}$	
Chip deselect to data retention time	$t_{CDR}$	0	—	—	ns	See retention waveform
Operation recovery time	$t_R$	$t_{RC}^{+4}$	—	—	ns	

- Notes: 1. Typical values are at  $V_{CC} = 3.0\text{ V}$ ,  $T_a = 25^\circ\text{C}$  and not guaranteed.  
 2.  $10\text{ }\mu\text{A}$  max at  $T_a = 0$  to  $40^\circ\text{C}$ .  
 3. This characteristics guaranteed for only L-SL version.  $3\text{ }\mu\text{A}$  max at  $T_a = 0$  to  $40^\circ\text{C}$ .  
 4.  $t_{RC}$  = Read cycle time.  
 5.  $\overline{CS2}$  controls address buffer,  $\overline{WE}$  buffer,  $\overline{CS1}$  buffer,  $\overline{OE}$  buffer, and  $D_{in}$  buffer. If  $\overline{CS2}$  controls data retention mode,  $V_{in}$  levels (address,  $\overline{WE}$ ,  $\overline{OE}$ ,  $\overline{CS1}$ , I/O) can be in the high impedance state. If  $\overline{CS1}$  controls data retention mode,  $\overline{CS2}$  must be  $CS2 \geq V_{CC} - 0.2\text{ V}$  or  $0\text{ V} \leq CS2 \leq 0.2\text{ V}$ . The other input levels (address,  $\overline{WE}$ ,  $\overline{OE}$ , I/O) can be in the high impedance state.

**Low  $V_{CC}$  Data Retention Timing Waveform (1) ( $\overline{CS1}$  Controlled)**

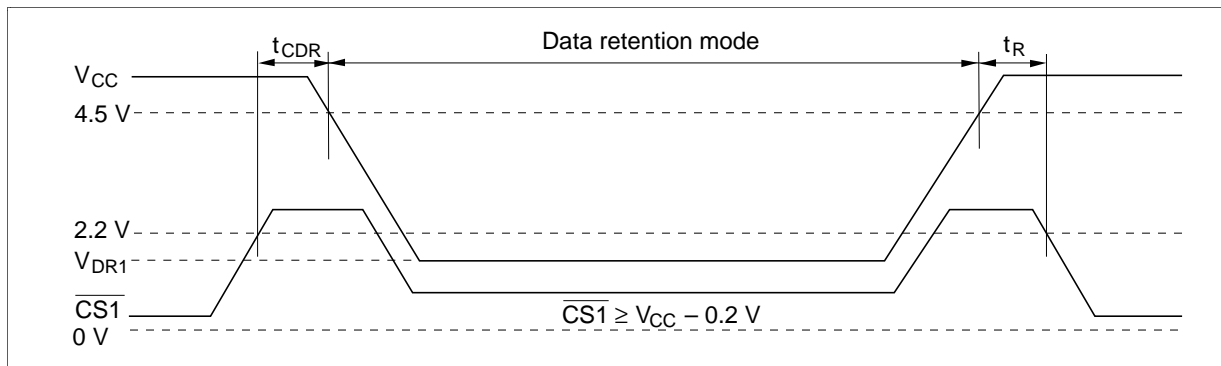

# HM62864 Series

## Low $V_{CC}$ Data Retention Timing Waveform (2) (CS2 Controlled)

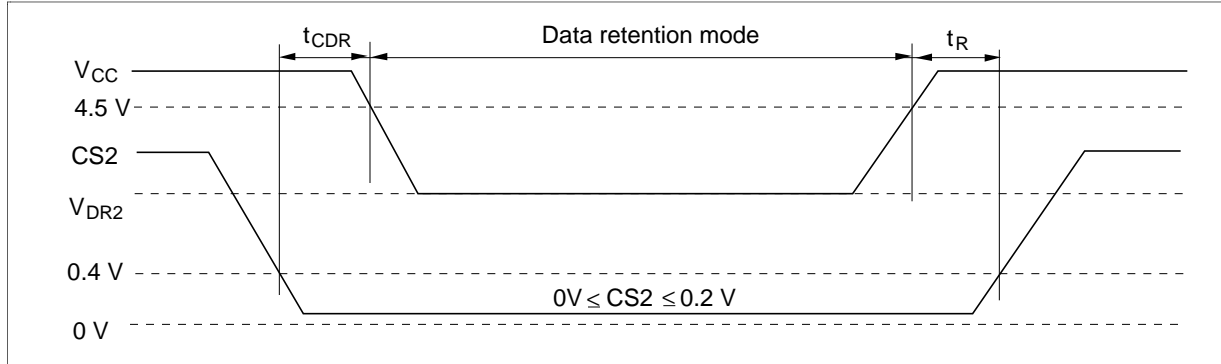

## Package Dimensions

### HM62864LFP Series (FP-32D)

Unit: mm

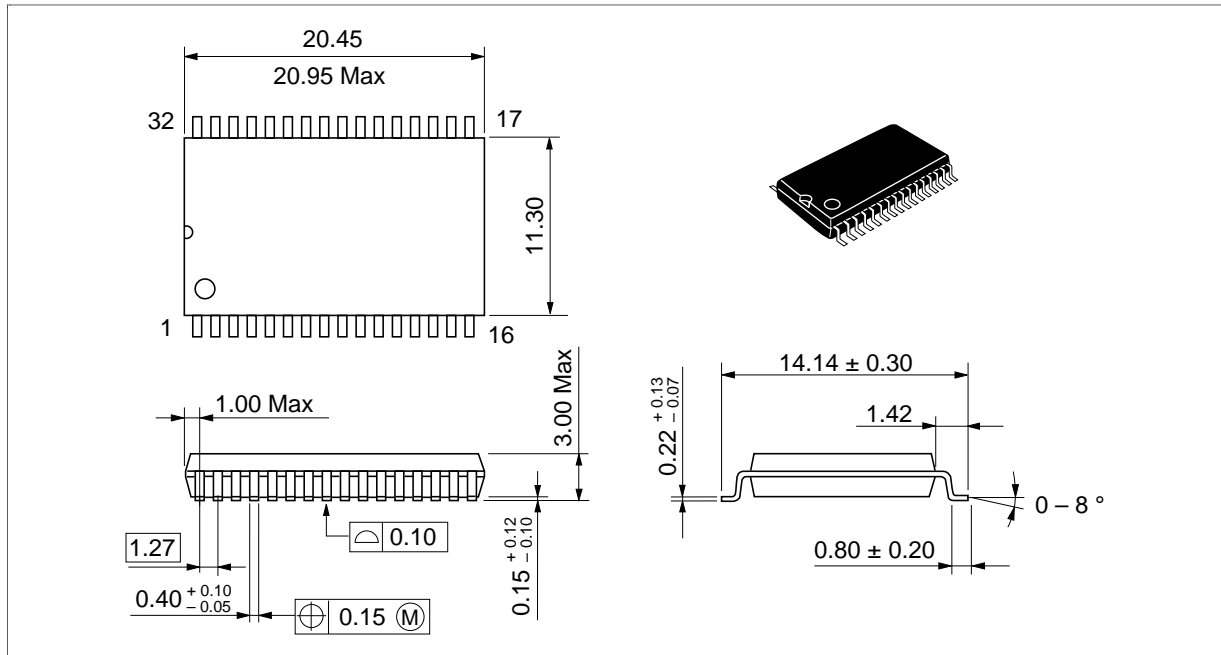

# HM62864 Series

HM62864LT Series (TFP-32D)

Unit: mm

