Revision History

Revision 0.1 (Oct. 23 1998)
-Original

Revision 0.2 (Dec. 4 1998)
-Add 200MHZ

Revision 1.0 (Dec. 10 1999)
-Delete Preliminary
-Rename the filename

Revision 1.1 (Jan. 26 2000)
-Add -5.5 Spec.

Revision 1.2 (Apr. 25 2000)
-Correct error typing of C1 dimension

Revision 1.3 (Nov. 27 2000)
-P5 Number of valid output data CAS Latency 3→ 2ea
-P17. P19. P21 Read Command shift right 1CLK
-P15. P19. P20 Precharge Command shift left 1CLK

Revision 1.4 (Feb. 22 2001)
-P6 modify tOH -6(2ns) & -7(2ns)

Revision 1.5 (Jun. 4 2001)
-P3. P4 modify DC current

Revision 1.6(Sep. 7 2001)
-P5 modify AC parameters

Revision 1.7 (Mar. 20 2002)
-P28 C1(Nom)=0.15mm→0.127mm
-P28 delete symbol=ZD

Revision 1.8 (Dec. 16 2003)
-Modify stand off=0.051~0.203mm

Revision 1.9 (Mar. 05 2004)
-Correct typing error of timing (tRC; tRP;tRCD)
-Add tRRD timing chart

Revision 2.0 (May. 10 2005)
Add "Pb-free" to ordering information

Revision 2.1 (Jul. 07 2005)
-Modify I_{CC1}, I_{CC2N}, I_{CC3N}, I_{CC4}, I_{CC5} spec
-Delete -5.5, -6, -8, -10 AC spec

Revision 2.2 (Oct. 06 2005)
-Add 60V FBGA

Revision 2.3 (Nov. 15 2005)
-Modify VFBGA 60Ball Total high spec

Revision 2.4 (May. 03 2007)
- Delete BGA ball name of packing dimensions

Revision 2.5 (Jun. 11 2007)
- Modify Pin Configuration (TOP VIEW)

Revision 2.6 (Jul. 20 2007)

- Modify tRAS(min) 40ns => 30ns and tRC(min) 55ns => 48ns

SDRAM

512K x 16Bit x 2Banks Synchronous DRAM

FEATURES

- JEDEC standard 3.3V power supply
- LVTTTL compatible with multiplexed address
- Dual banks operation
- MRS cycle with address key programs
 - CAS Latency (2 & 3)
 - Burst Length (1, 2, 4, 8 & full page)
 - Burst Type (Sequential & Interleave)
- All inputs are sampled at the positive going edge of the system clock
- Burst Read Single-bit Write operation
- DQM for masking
- Auto & self refresh
- 32ms refresh period (2K cycle)

GENERAL DESCRIPTION

The M12L16161A is 16,777,216 bits synchronous high data rate Dynamic RAM organized as 2 x 524,288 words by 16 bits, fabricated with high performance CMOS technology. Synchronous design allows precise cycle control with the use of system clock I/O transactions are possible on every clock cycle. Range of operating frequencies, programmable burst length and programmable latencies allow the same device to be useful for a variety of high bandwidth, high performance memory system applications.

ORDERING INFORMATION

Part NO.	MAX Freq.	PACKAGE	COMMENTS
M12L16161A-5TG	200MHz	TSOP(II)	Pb-free
M12L16161A-7TG	143MHz	TSOP(II)	Pb-free
M12L16161A-7BG	143MHz	VFPGA	Pb-free

PIN CONFIGURATION (TOP VIEW)

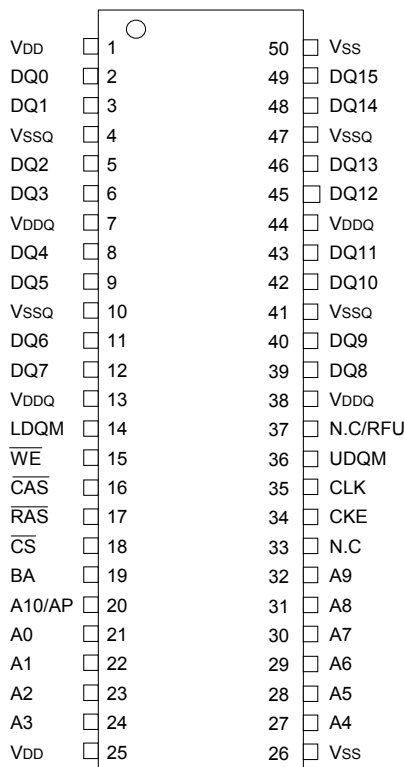

50PIN TSOP(II)
(400mil x 825mil)
(0.8 mm PIN PITCH)

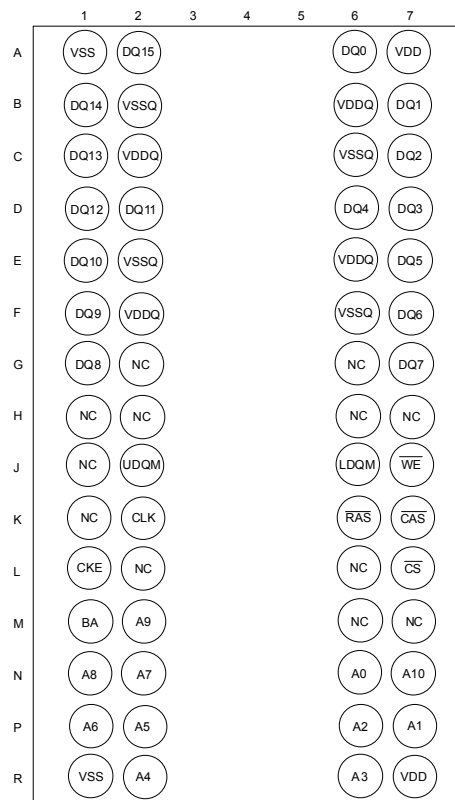

60 Ball VFPGA
(6.4x10.1mm)
(0.65mm ball pitch)

FUNCTIONAL BLOCK DIAGRAM

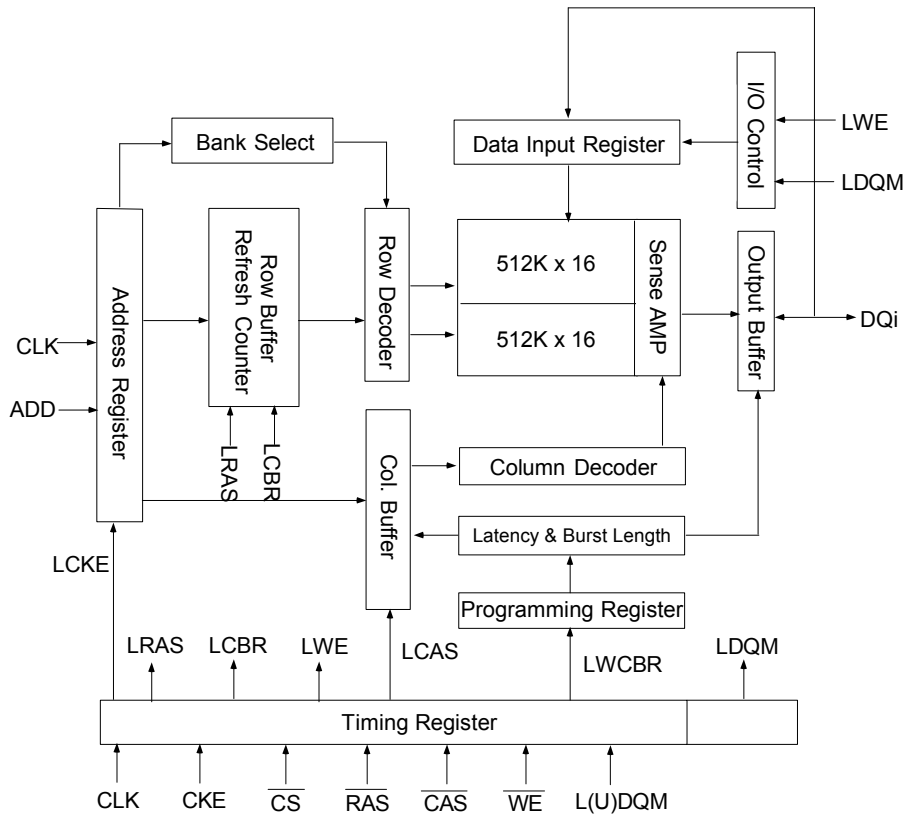

PIN FUNCTION DESCRIPTION

Pin	Name	Input Function
CLK	System Clock	Active on the positive going edge to sample all inputs.
\overline{CS}	Chip Select	Disables or enables device operation by masking or enabling all inputs except CLK, CKE and L(U)DQM.
CKE	Clock Enable	Masks system clock to freeze operation from the next clock cycle. CKE should be enabled at least one cycle prior to new command. Disable input buffers for power down in standby.
A0 ~ A10/AP	Address	Row / column addresses are multiplexed on the same pins. Row address : RA0 ~ RA10, column address : CA0 ~ CA7
BA	Bank Select Address	Selects bank to be activated during row address latch time. Selects bank for read/write during column address latch time.
\overline{RAS}	Row Address Strobe	Latches row addresses on the positive going edge of the CLK with \overline{RAS} low. Enables row access & precharge.
\overline{CAS}	Column Address Strobe	Latches column addresses on the positive going edge of the CLK with \overline{CAS} low. Enables column access.
\overline{WE}	Write Enable	Enables write operation and row precharge. Latches data in starting from \overline{CAS} , \overline{WE} active.
L(U)DQM	Data Input / Output Mask	Makes data output Hi-Z, tSHZ after the clock and masks the output. Blocks data input when L(U)DQM active.

DQ0 ~ 15	<i>Data Input / Output</i>	Data inputs/outputs are multiplexed on the same pins.
VDD/VSS	<i>Power Supply/Ground</i>	Power and ground for the input buffers and the core logic.
VDDQ/VSSQ	<i>Data Output Power/Ground</i>	Isolated power supply and ground for the output buffers to provide improved noise immunity.
N.C/RFU	<i>No Connection/ Reserved for Future Use</i>	This pin is recommended to be left No Connection on the device.

ABSOLUTE MAXIMUM RATINGS

Parameter	Symbol	Value	Unit
Voltage on any pin relative to V _{SS}	V _{IN} , V _{OUT}	-1.0 ~ 4.6	V
Voltage on V _{DD} supply relative to V _{SS}	V _{DD} , V _{DDQ}	-1.0 ~ 4.6	V
Storage temperature	T _{STG}	-55 ~ + 150	°C
Power dissipation	P _D	0.7	W
Short circuit current	I _{OS}	50	MA

Note: Permanent device damage may occur if ABSOLUTE MAXIMUM RATINGS are exceeded.
 Functional operation should be restricted to recommended operating condition.
 Exposure to higher than recommended voltage for extended periods of time could affect device reliability.

DC OPERATING CONDITIONS

Recommended operating conditions (Voltage referenced to V_{SS} = 0V, T_A=0 to 70 °C)

Parameter	Symbol	Min	Typ	Max	Unit	Note
Supply voltage	V _{DD} , V _{DDQ}	3.0	3.3	3.6	V	
Input logic high voltage	V _{IH}	2.0	3.0	V _{DD} +0.3	V	1
Input logic low voltage	V _{IL}	-0.3	0	0.8	V	2
Output logic high voltage	V _{OH}	2.4	-	-	V	I _{OH} = -2mA
Output logic low voltage	V _{OL}	-	-	0.4	V	I _{OL} = 2mA
Input leakage current	I _{IL}	-5	-	5	uA	3
Output leakage current	I _{OL}	-5	-	5	uA	4

Note : 1. V_{IH} (max) = 4.6V AC for pulse width ≤ 10ns acceptable.
 2. V_{IL} (min) = -1.5V AC for pulse width ≤ 10ns acceptable.
 3. Any input 0V ≤ V_{IN} ≤ V_{DD}+ 0.3V, all other pins are not under test = 0V.
 4. Dout is disabled, 0V ≤ V_{OUT} ≤ V_{DD}.

CAPACITANCE (V_{DD} = 3.3V, T_A = 25 °C , f = 1MHz)

Pin	Symbol	Min	Max	Unit
CLOCK	C _{CLK}	2.5	4.0	pF
RAS, CAS, WE, CS, CKE, LDQM, UDQM	C _{IN}	2.5	5.0	pF
ADDRESS	C _{ADD}	2.5	5.0	pF
DQ0 ~DQ15	C _{OUT}	4.0	6.5	pF

DC CHARACTERISTICS

(Recommended operating condition unless otherwise noted, T_A = 0 to 70 °C V_{IH}(min)/V_{IL}(max)=2.0V/0.8V)

Parameter	Symbol	Test Condition	CAS Latency	Version		Unit	Note
				-5	-7		
Operating Current (One Bank Active)	I _{CC1}	Burst Length = 1 t _{RC} ≥ t _{RC} (min), t _{CC} ≥ t _{CC} (min), I _{OL} = 0mA		130	100	mA	1
Precharge Standby Current in power-down mode	I _{CC2P}	CKE ≤ V _{IL} (max), t _{CC} = 15ns		2		mA	
	I _{CC2PS}	CKE ≤ V _{IL} (max), CLK ≤ V _{IL} (max), t _{CC} = ∞		2			
Precharge Standby Current in non power-down mode	I _{CC2N}	CKE ≥ V _{IH} (min), \overline{CS} ≥ V _{IH} (min), t _{CC} = 15ns Input signals are changed one time during 30ns		25		mA	
	I _{CC2NS}	CKE ≥ V _{IH} (min), CLK ≤ V _{IL} (max), t _{CC} = ∞ Input signals are stable		10		mA	
Active Standby Current in power-down mode	I _{CC3P}	CKE ≤ V _{IL} (max), t _{CC} = 15ns		10		mA	
	I _{CC3PS}	CKE ≤ V _{IL} (max), CLK ≤ V _{IL} (max), t _{CC} = ∞		10			
Active Standby Current in non power-down mode (One Bank Active)	I _{CC3N}	CKE ≥ V _{IH} (min), \overline{CS} ≥ V _{IH} (min), t _{CC} =15ns Input signals are changed one time during 30ns		25		mA	
	I _{CC3NS}	CKE ≥ V _{IH} (min), CLK ≤ V _{IL} (max), t _{CC} =∞ Input signals are stable		10		mA	
Operating Current (Burst Mode)	I _{CC4}	I _{OL} = 0Ma, Page Burst All Band Activated, t _{CCD} = t _{CCD} (min)	3	150	120	mA	1
			2	150	120		
Refresh Current	I _{CC5}	t _{RC} ≥ t _{RC} (min)		150	120	mA	2
Self Refresh Current	I _{CC6}	CKE ≤ 0.2V		1		mA	

Note: 1.Measured with outputs open. Addresses are changed only one time during t_{CC}(min).

2.Refresh period is 32ms. Addresses are changed only one time during t_{CC}(min).

AC OPERATING TEST CONDITIONS ($V_{DD}=3.3V \pm 0.3V, T_A= 0 \text{ to } 70^\circ\text{C}$)

Parameter	Value	Unit
Input levels (V_{ih}/V_{il})	2.4 / 0.4	V
Input timing measurement reference level	1.4	V
Input rise and fall time	$t_r / t_f = 1 / 1$	ns
Output timing measurement reference level	1.4	V
Output load condition	See Fig.2	

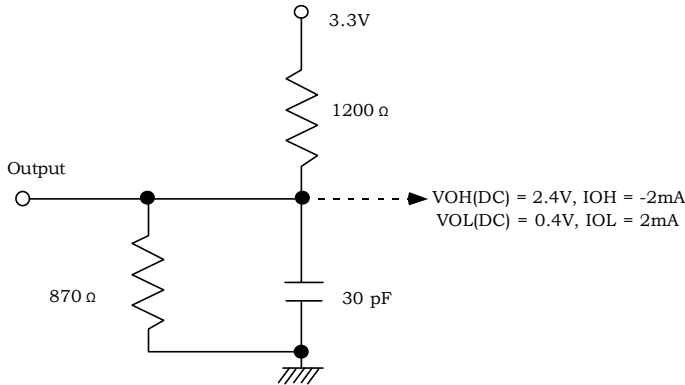

(Fig.1) DC Output Load circuit

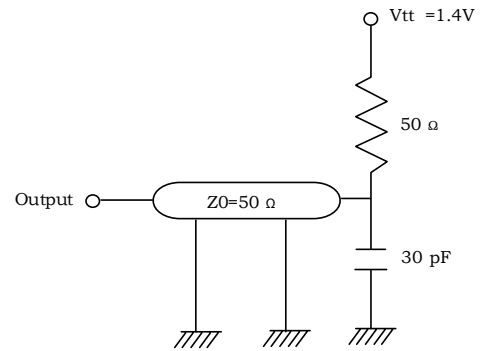

(Fig.2) AC Output Load Circuit

OPERATING AC PARAMETER

(AC operating conditions unless otherwise noted)

Parameter	Symbol	Version		Unit	Note
		-5	-7		
Row active to row active delay	$t_{RRD}(\text{min})$	10	14	ns	1
$\overline{\text{RAS}}$ to $\overline{\text{CAS}}$ delay	$t_{RCD}(\text{min})$	15	20	ns	1
Row precharge time	$t_{RP}(\text{min})$	15	20	ns	1
Row active time	$t_{RAS}(\text{min})$	30	42	ns	1
	$t_{RAS}(\text{max})$	100		us	
Row cycle time	$t_{RC}(\text{min})$	48	63	ns	1
Last data in to new col. Address delay	$t_{CDL}(\text{min})$	1		CLK	2
Last data in to row precharge	$t_{RD}(\text{min})$	2		CLK	2
Last data in to burst stop	$t_{BDL}(\text{min})$	1		CLK	2
Col. Address to col. Address delay	$t_{CCD}(\text{min})$	1		CLK	3
Number of valid output data	CAS latency=3	2		ea	4
	CAS latency=2	1			

- Note:**
- The minimum number of clock cycles is determined by dividing the minimum time required with clock cycle time and then rounding off to the next higher integer.
 - Minimum delay is required to complete write.
 - All parts allow every cycle column address change.
 - In case of row precharge interrupt, auto precharge and read burst stop.
The earliest a precharge command can be issued after a Read command without the loss of data is $CL+BL-2$ clocks.

AC CHARACTERISTICS (AC operating conditions unless otherwise noted)

Parameter		Symbol	-5		-7		Unit	Note
			Min	Max	Min	Max		
CLK cycle time	CAS Latency =3	t _{CC}	5	1000	7	1000	ns	1
	CAS Latency =2		7		8.6			
CLK to valid output delay	CAS Latency =3	t _{SAC}	-	4.5	-	6	ns	1
	CAS Latency =2		-	5	-	6		
Output data hold time		t _{OH}	2		2		ns	2
CLK high pulse width		t _{CH}	2		2.5		ns	3
CLK low pulse width		t _{CL}	2		2.5		ns	3
Input setup time		t _{SS}	2		2		ns	3
Input hold time		t _{SH}	1		1		ns	3
CLK to output in Low-Z		t _{SLZ}	1		1		ns	2
CLK to output in Hi-Z	CAS Latency =3	t _{SHZ}	-	5.5	-	6	ns	
	CAS latency =2		-	5.5	-	6		

*All AC parameters are measured from half to half.

Note: 1.Parameters depend on programmed CAS latency.

2.If clock rising time is longer than 1ns,(tr/2-0.5)ns should be added to the parameter.

3.Assumed input rise and fall time (tr & tf)=1ns.

If tr & tf is longer than 1ns, transient time compensation should be considered, i.e., [(tr+ tf)/2-1]ns should be added to the parameter.

Mode Register

11	10	9	8	7	6	5	4	3	2	1	0		
0	0	0	0	1									JEDEC Standard Test Set (refresh counter test)
11	10	9	8	7	6	5	4	3	2	1	0		
x	x	1	0	0	LTMODE	WT	BL					Burst Read and Single Write (for Write Through Cache)	
11	10	9	8	7	6	5	4	3	2	1	0		
			1	0									Use in future
11	10	9	8	7	6	5	4	3	2	1	0		
x	x	x	1	1	v	v	v	v	v	v	v		Vender Specific
11	10	9	8	7	6	5	4	3	2	1	0		
0	0	0	0	0	LTMODE	WT	BL					Mode Register Set	

v =Valid
x =Don't care

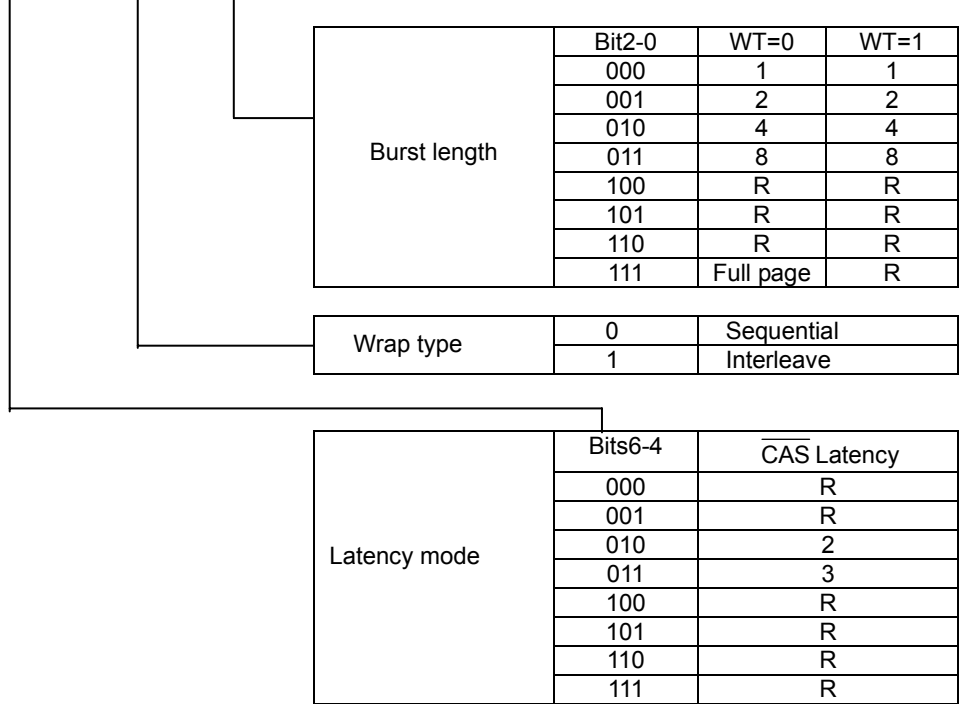

Remark R : Reserved

Mode Register Write Timing

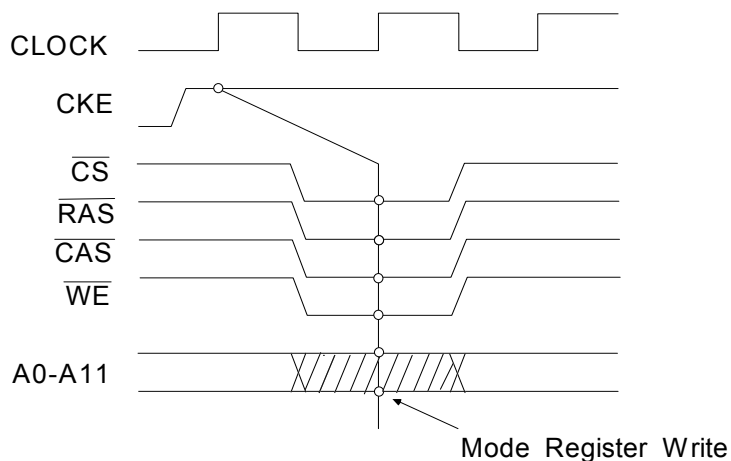

Burst Length and Sequence

(Burst of Two)

Starting Address (column address A0 binary)	Sequential Addressing Sequence (decimal)	Interleave Addressing Sequence (decimal)
0	0, 1	0, 1
1	1, 0	1, 0

(Burst of Four)

Starting Address (column address A1-A0, binary)	Sequential Addressing Sequence (decimal)	Interleave Addressing Sequence (decimal)
00	0, 1, 2, 3	0, 1, 2, 3
01	1, 2, 3, 0	1, 0, 3, 2
10	2, 3, 0, 1	2, 3, 0, 1
11	3, 0, 1, 2	3, 2, 1, 0

(Burst of Eight)

Starting Address (column address A2-A0, binary)	Sequential Addressing Sequence (decimal)	Interleave Addressing Sequence (decimal)
000	0, 1, 2, 3, 4, 5, 6, 7	0, 1, 2, 3, 4, 5, 6, 7
001	1, 2, 3, 4, 5, 6, 7, 0	1, 0, 3, 2, 5, 4, 7, 6
010	2, 3, 4, 5, 6, 7, 0, 1	2, 3, 0, 1, 6, 7, 4, 5
011	3, 4, 5, 6, 7, 0, 1, 2	3, 2, 1, 0, 7, 6, 5, 4
100	4, 5, 6, 7, 0, 1, 2, 3	4, 5, 6, 7, 0, 1, 2, 3
101	5, 6, 7, 0, 1, 2, 3, 4	5, 4, 7, 6, 1, 0, 3, 2
110	6, 7, 0, 1, 2, 3, 4, 5	6, 7, 4, 5, 2, 3, 0, 1
111	7, 0, 1, 2, 3, 4, 5, 6	7, 6, 5, 4, 3, 2, 1, 0

Full page burst is an extension of the above tables of Sequential Addressing, with the length being 256 for 1Mx16 device.

POWER UP SEQUENCE

1. Apply power and start clock, attempt to maintain CKE= "H", L(U)DQM = "H" and the other pin are NOP condition at the inputs.
 2. Maintain stable power, stable clock and NOP input condition for a minimum of 200us.
 3. Issue precharge commands for all banks of the devices.
 4. Issue 2 or more auto-refresh commands.
 5. Issue mode register set command to initialize the mode register.
- Cf.) Sequence of 4 & 5 is regardless of the order.

SIMPLIFIED TRUTH TABLE

COMMAND		CKEn-1	CKEn	\overline{CS}	\overline{RAS}	\overline{CAS}	\overline{WE}	DQM	BA	A10/AP	A9~A0	Note
Register	Mode Register Set	H	X	L	L	L	L	X	OP CODE			1,2
Refresh	Auto Refresh	H	H	L	L	L	H	X	X	X	X	3
	Entry		L									3
	Self Refresh	L	H	L	H	H	H	X	X	X	X	3
				Exit	H	X	X					3
Bank Active & Row Addr.		H	X	L	L	H	H	X	V	Row Address		
Read & Column Address	Auto Precharge Disable	H	X	L	H	L	H	X	V	L	Column Address (A0~A7)	4
	Auto Precharge Enable									H	4,5	
Write & Column Address	Auto Precharge Disable	H	X	L	H	L	L	X	V	L	Column Address (A0~A7)	4
	Auto Precharge Enable									H	4,5	
Burst Stop		H	X	L	H	H	L	X	X		6	
Precharge	Bank Selection	H	X	L	L	H	L	X	V	L	X	4
	Both Banks								X	H		4
Clock Suspend or Active Power Down	Entry	H	L	H	X	X	X	X	X			
	Exit			L	H	X	X					X
Precharge Power Down Mode	Entry	H	L	H	X	X	X	X	X			
				L	H	H	H					
	Exit	L	H	H	X	X	X	X				
				L	V	V	V					
DQM		H	X					V	X		7	
No Operation Command		H	X	H	X	X	X	X	X			
		H		L	H	H	H					

(V= Valid, X= Don't Care, H= Logic High , L = Logic Low)

Note:

- OP Code: Operation Code
A0~ A10/AP, BA: Program keys.(@MRS)
- MRS can be issued only at both banks precharge state.
A new command can be issued after 2 clock cycle of MRS.
- Auto refresh functions are as same as CBR refresh of DRAM.
The automatical precharge without row precharge command is meant by "Auto".
Auto / self refresh can be issued only at both banks idle state.
- BA: Bank select address.
If "Low": at read, write, row active and precharge, bank A is selected.
If "High": at read, write, row active and precharge, bank B is selected.
If A10/AP is "High" at row precharge, BA ignored and both banks are selected.
- During burst read or write with auto precharge, new read/write command can not be issued.
Another bank read /write command can be issued after the end of burst.
New row active of the associated bank can be issued at t_{RP} after the end of burst.
- Burst stop command is valid at every burst length.
- DQM sampled at positive going edge of a CLK masks the data-in at the very CLK (Write DQM latency is 0), but makes
Hi-Z state the data-out of 2 CLK cycles after. (Read DQM latency is 2)

Single Bit Read-Write-Read Cycle (Same Page) @CAS Latency=3, Burst Length=1

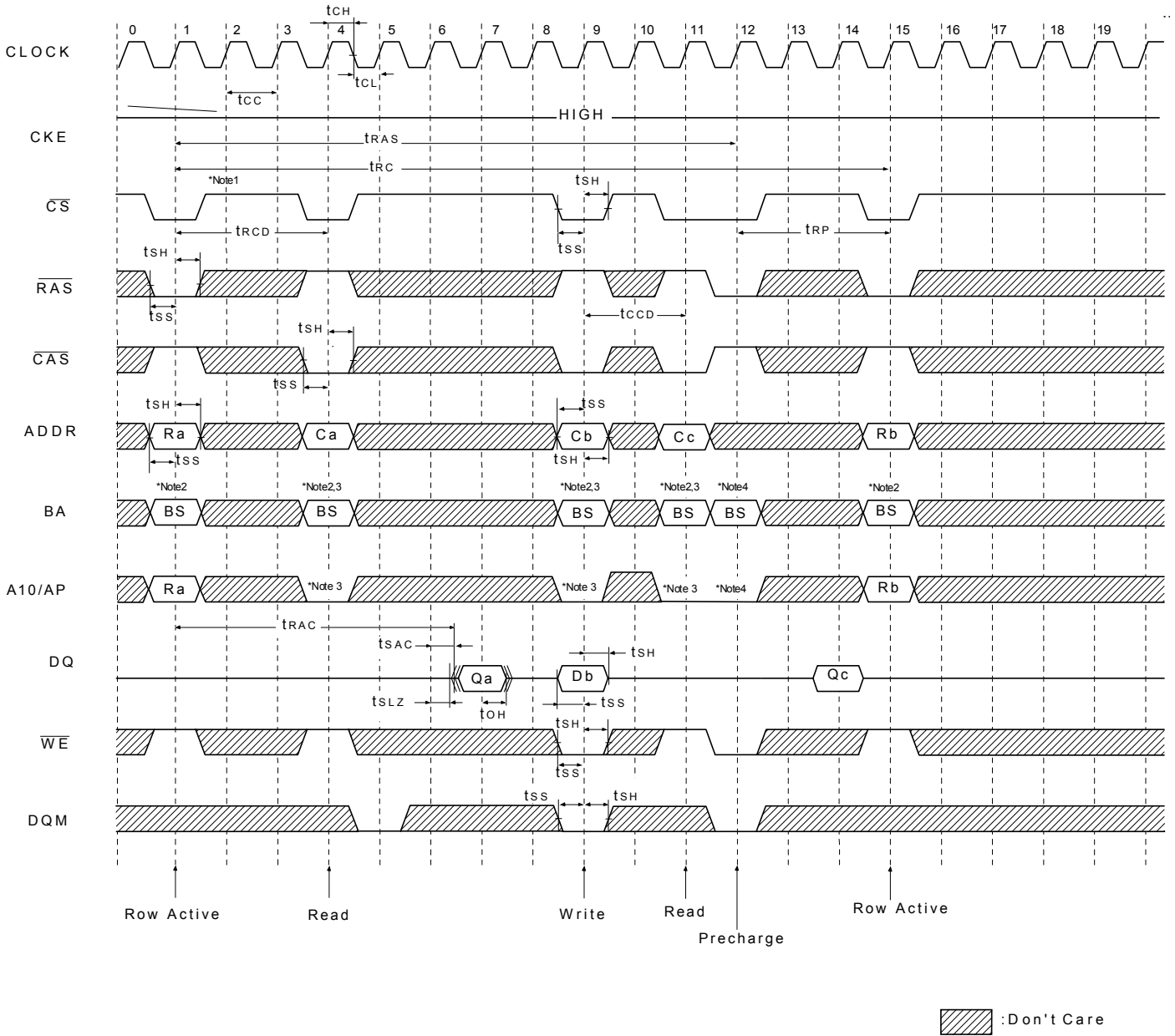

***Note:** 1. All inputs expect CKE & DQM can be don't care when \overline{CS} is high at the CLK high going edge.

2. Bank active & read/write are controlled by BA.

BA	Active & Read/Write
0	Bank A
1	Bank B

3. Enable and disable auto precharge function are controlled by A10/AP in read/write command.

A10/AP	BA	Operation
0	0	Disable auto precharge, leave bank A active at end of burst.
	1	Disable auto precharge, leave bank B active at end of burst.
1	0	Enable auto precharge, precharge bank A at end of burst.
	1	Enable auto precharge, precharge bank B at end of burst.

4. A10/AP and BA control bank precharge when precharge command is asserted.

A10/AP	BA	precharge
0	0	Bank A
0	1	Bank B
1	X	Both Banks

Power Up Sequence

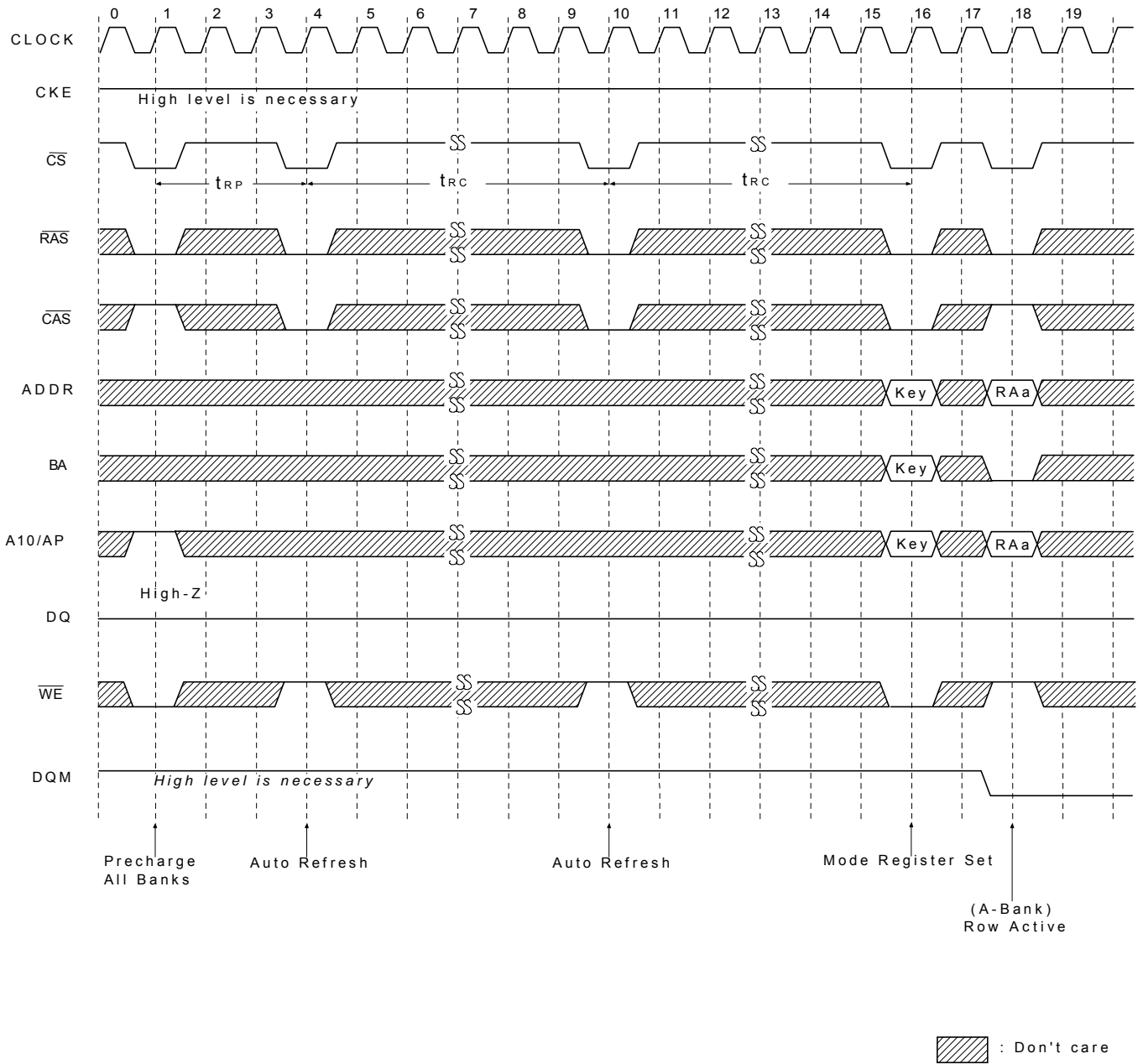

Read & Write Cycle at Same Bank @Burst Length = 4

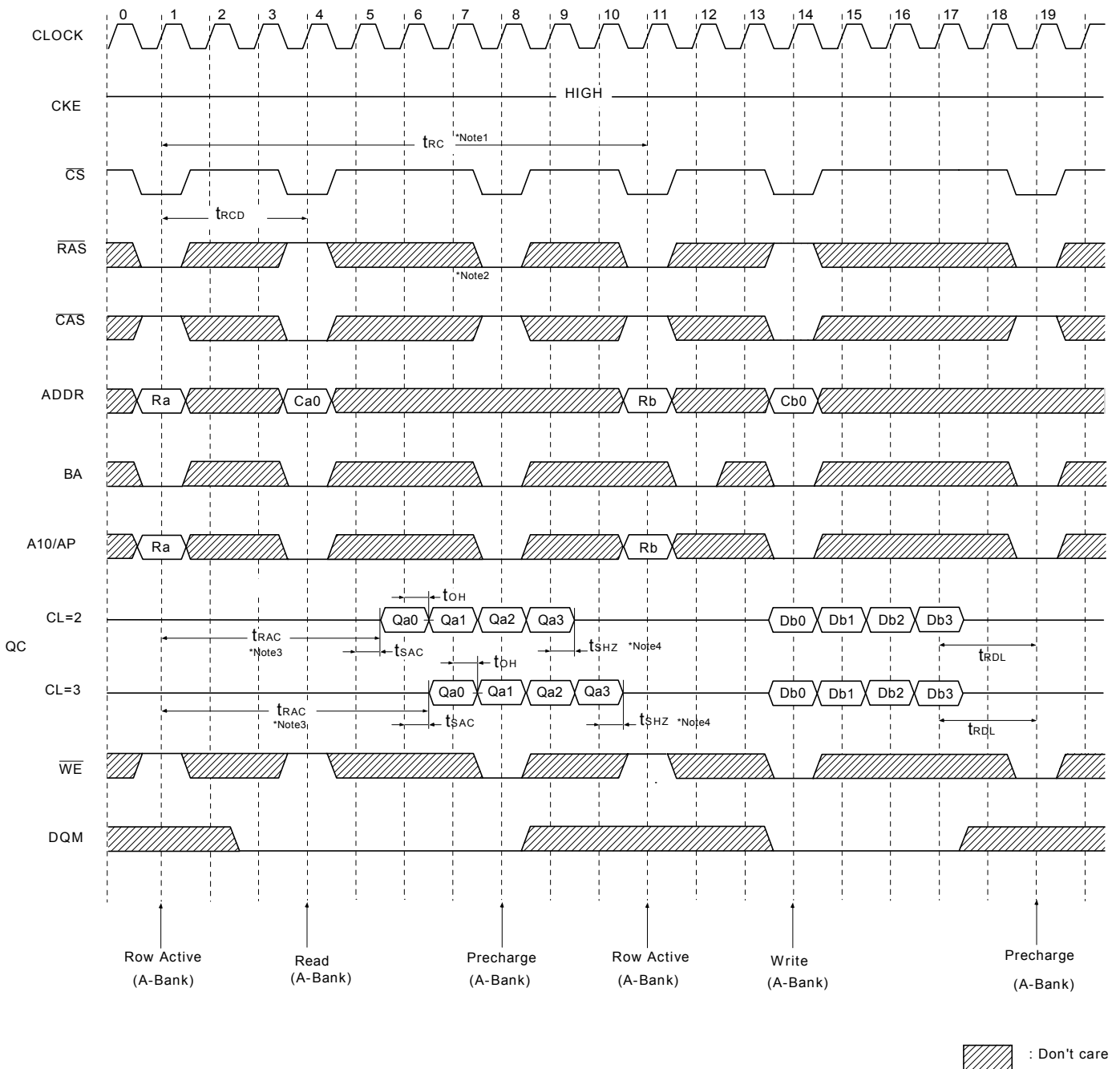

***Note:** 1. Minimum row cycle times is required to complete internal DRAM operation.

2. Row precharge can interrupt burst on any cycle. [CAS Latency-1] number of valid output data is available after Row precharge. Last valid output will be Hi-Z(t_{SHZ}) after the clock.

3. Access time from Row active command. $t_{CC} * (t_{RCD} + CAS\ latency - 1) + t_{SAC}$

4. Output will be Hi-Z after the end of burst. (1,2,4,8 bit burst)

Burst can't end in Full Page Mode.

Page Read & Write Cycle at Same Bank @ Burst Length=4

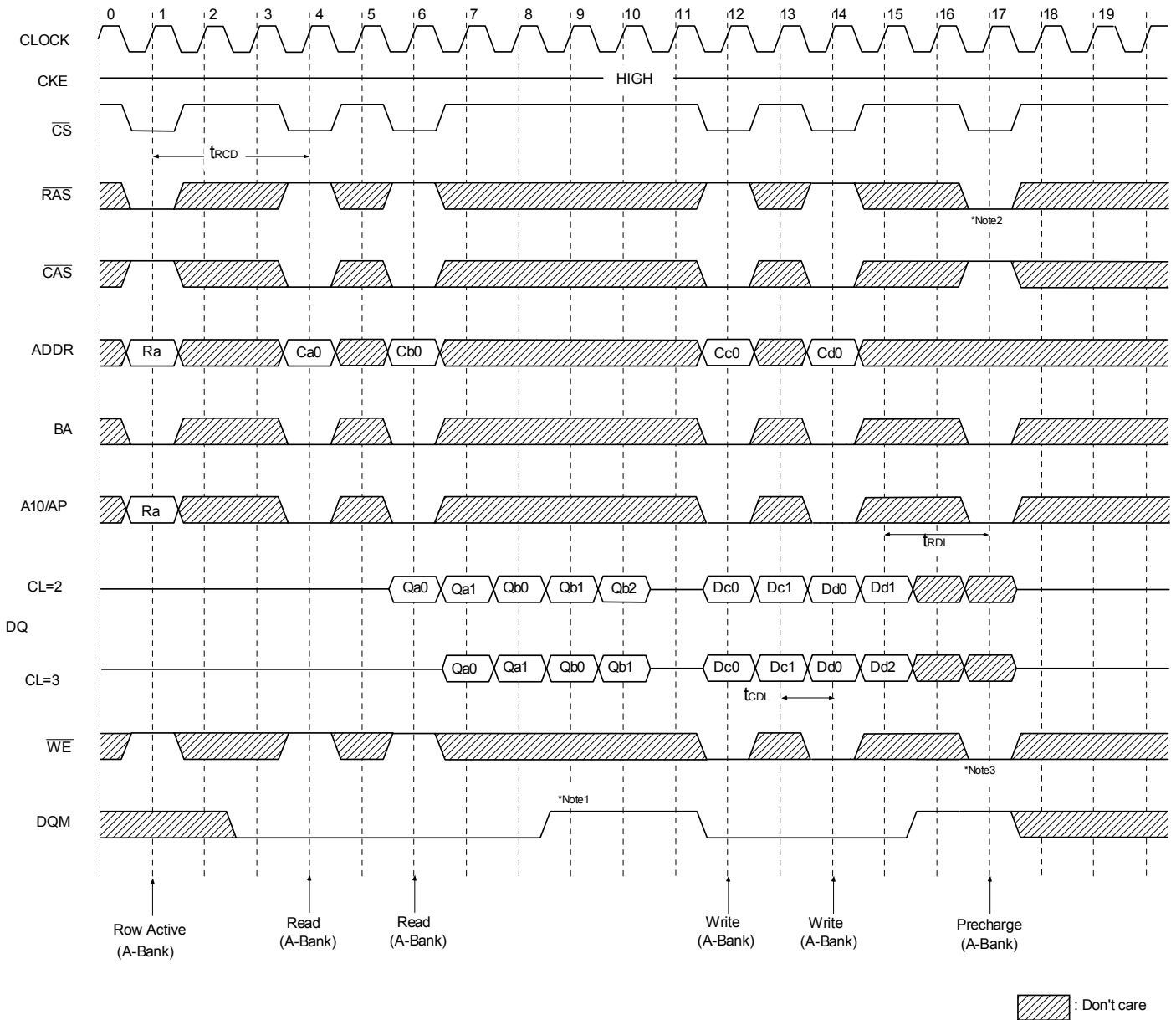

***Note 1:** To write data before burst read ends, DQM should be asserted three cycle prior to write command to avoid bus contention.

2. Row precharge will interrupt writing. Last data input, t_{RDL} before Row precharge, will be written.

3. DQM should mask invalid input data on precharge command cycle when asserting precharge before end of burst.

Input data after Row precharge cycle will be masked internally.

Page Read Cycle at Different Bank @ Burst Length=4

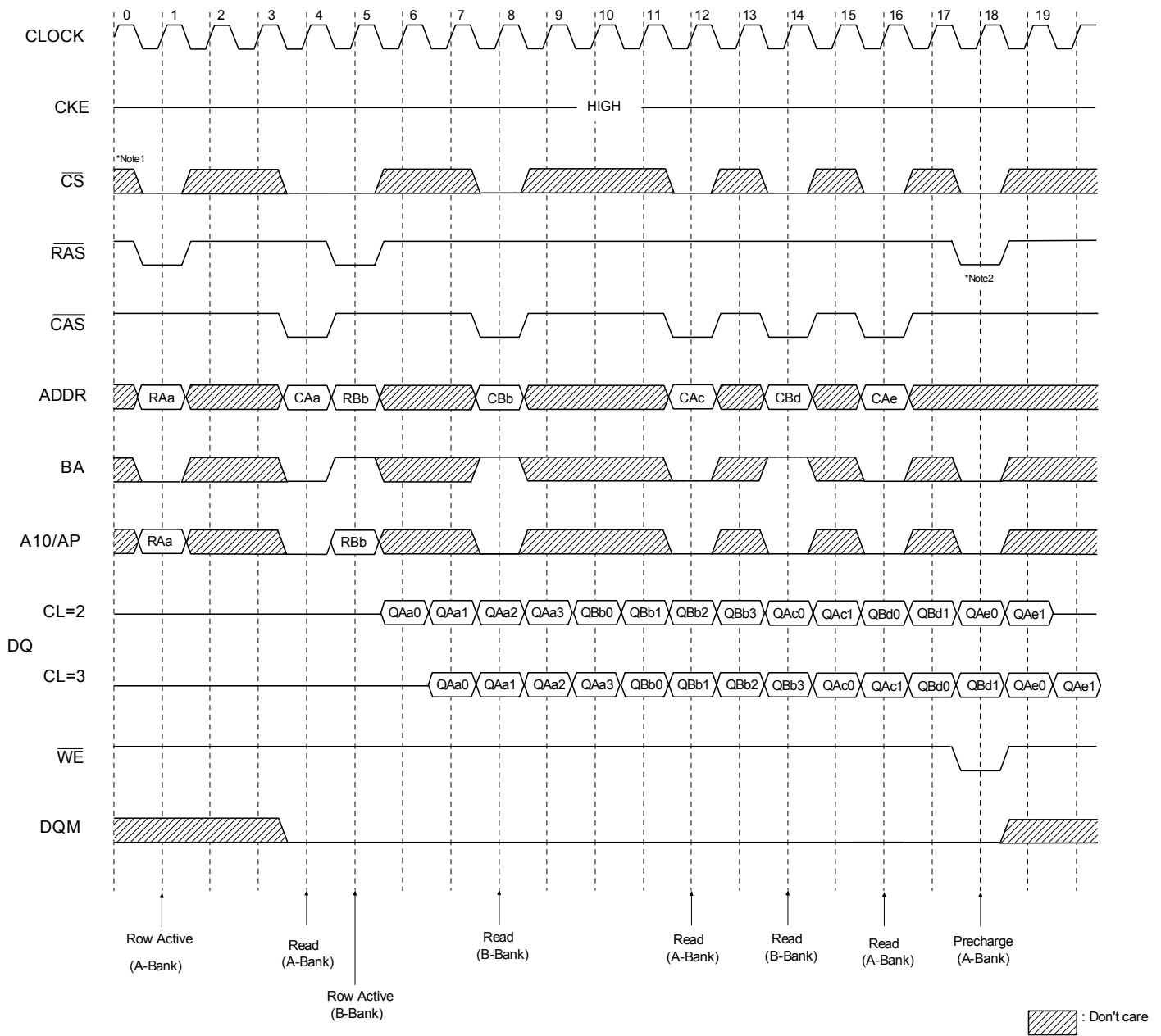

*Note: 1. \overline{CS} can be don't cared when \overline{RAS} , \overline{CAS} and \overline{WE} are high at the clock high going dege.

2. To interrupt a burst read by row precharge, both the read and the precharge banks must be the same.

Page Write Cycle at Different Bank @Burst Length = 4

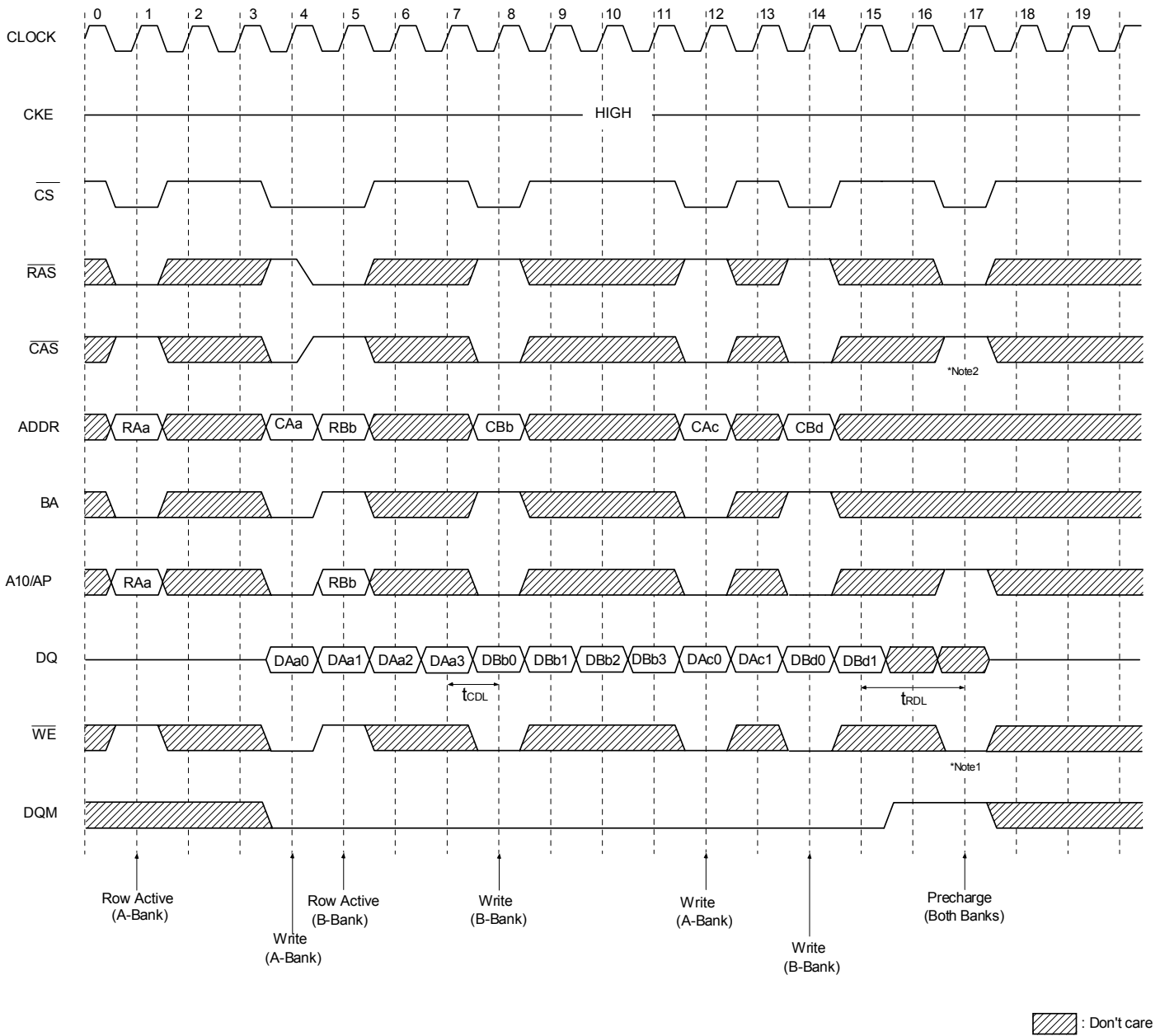

*Note: 1. To interrupt burst write by Row precharge, DQM should be asserted to mask invalid input data.

2. To interrupt burst write by row precharge, both the write and the precharge banks must be the same.

Read & Write Cycle at Different Bank @ Burst Length = 4

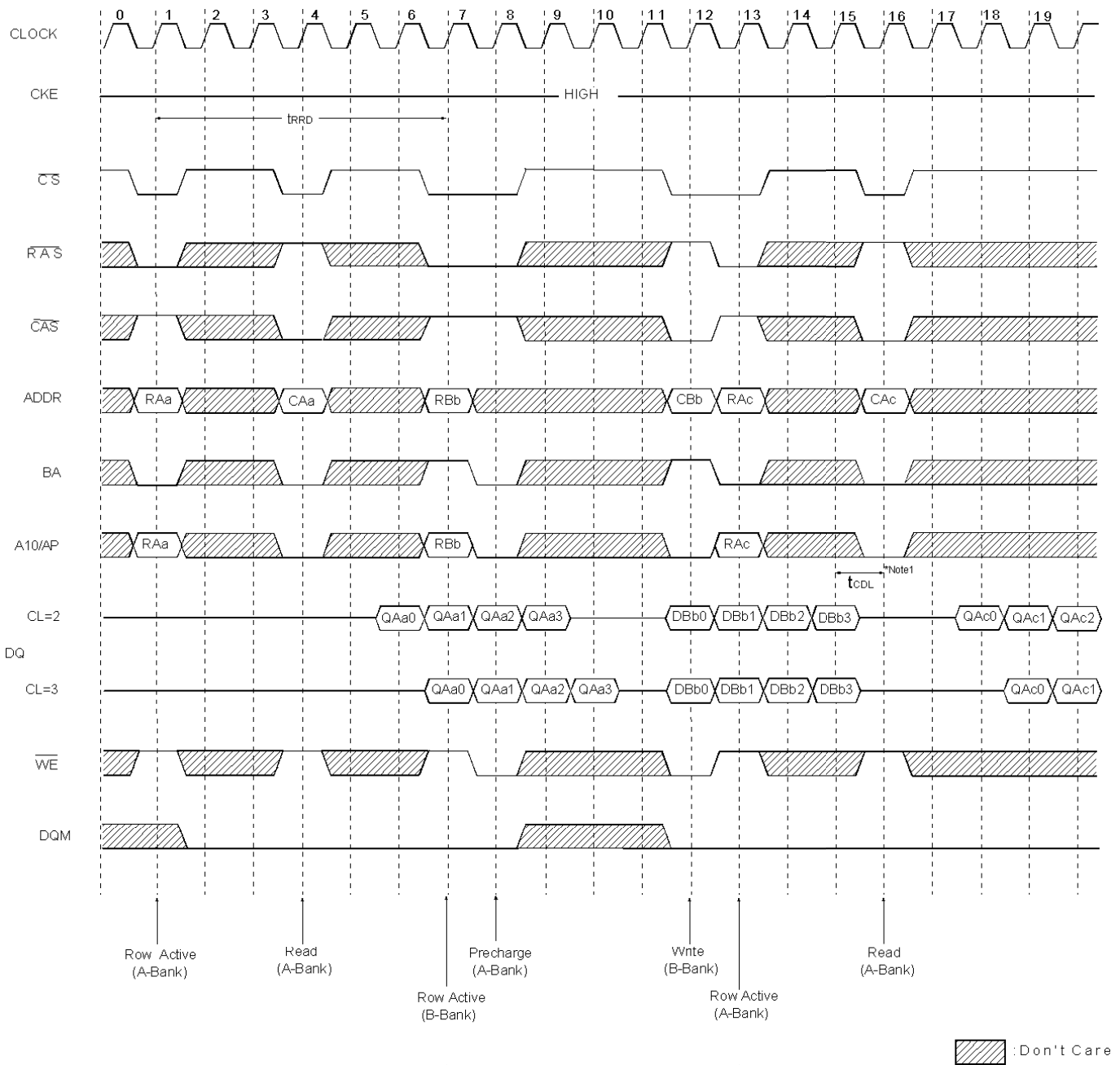

*Note: 1. t_{CDL} should be met to complete write.

Read & Write Cycle with auto Precharge @ Burst Length =4

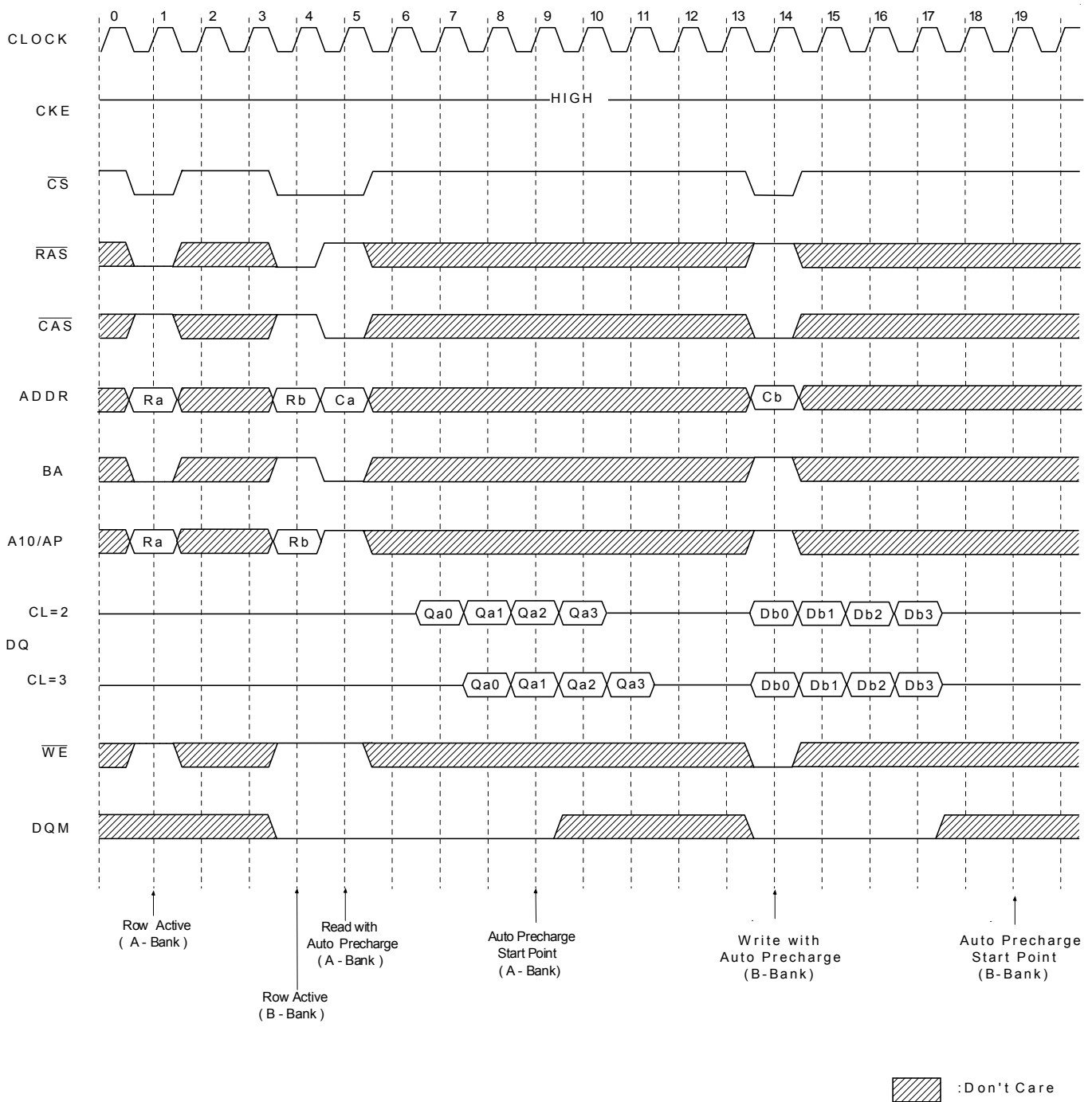

*Note: 1.t_{CDL} Should be controlled to meet minimum t_{RAS} before internal precharge start
 (In the case of Burst Length=1 & 2 and BRSW mode)

Clock Suspension & DQM Operation Cycle @CAS Latency=2, Burst Length=4

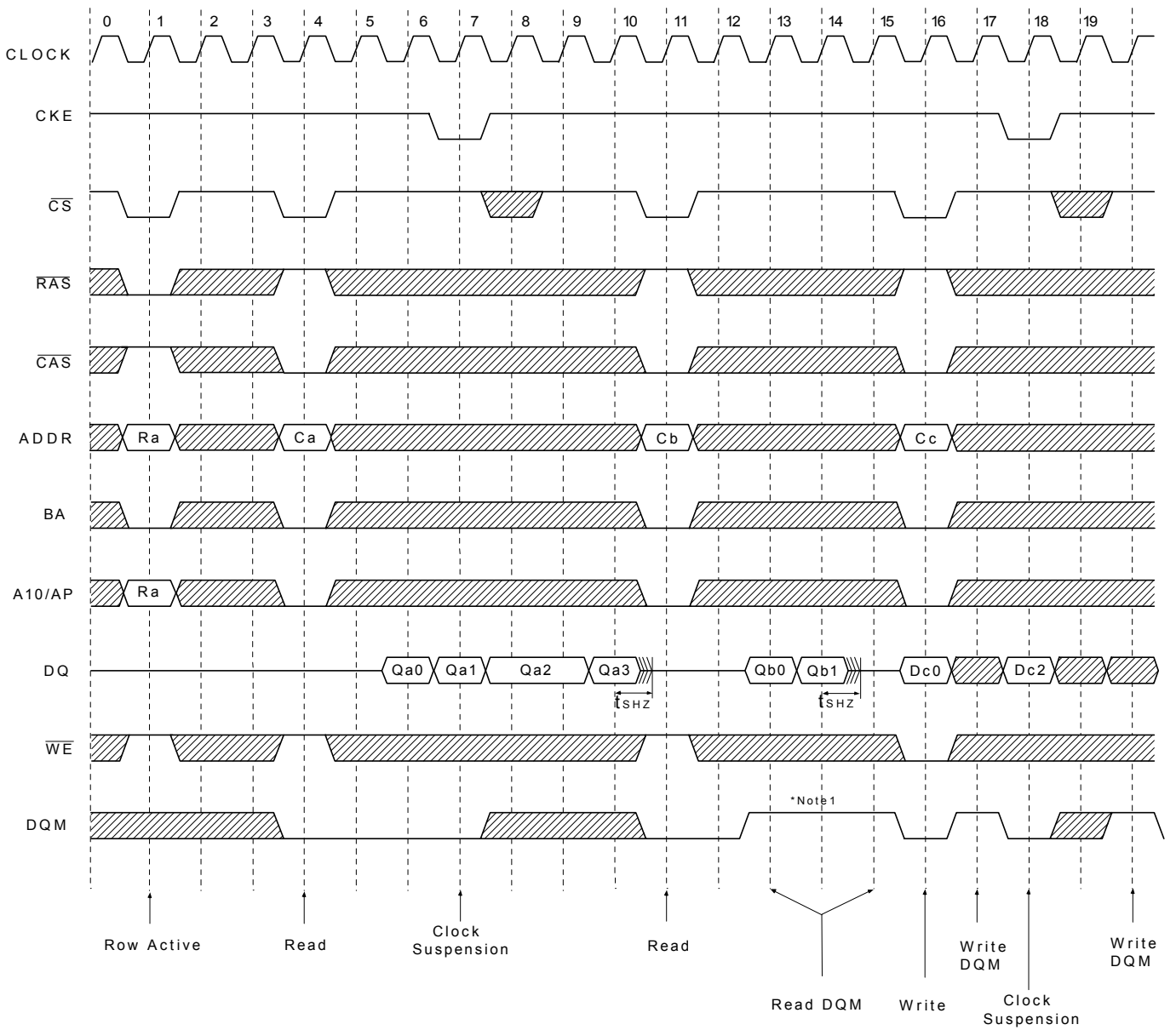

*Note:1.DQM is needed to prevent bus contention.

Read Interrupted by Precharge Command & Read Burst Stop Cycle @Burst Length =Full page

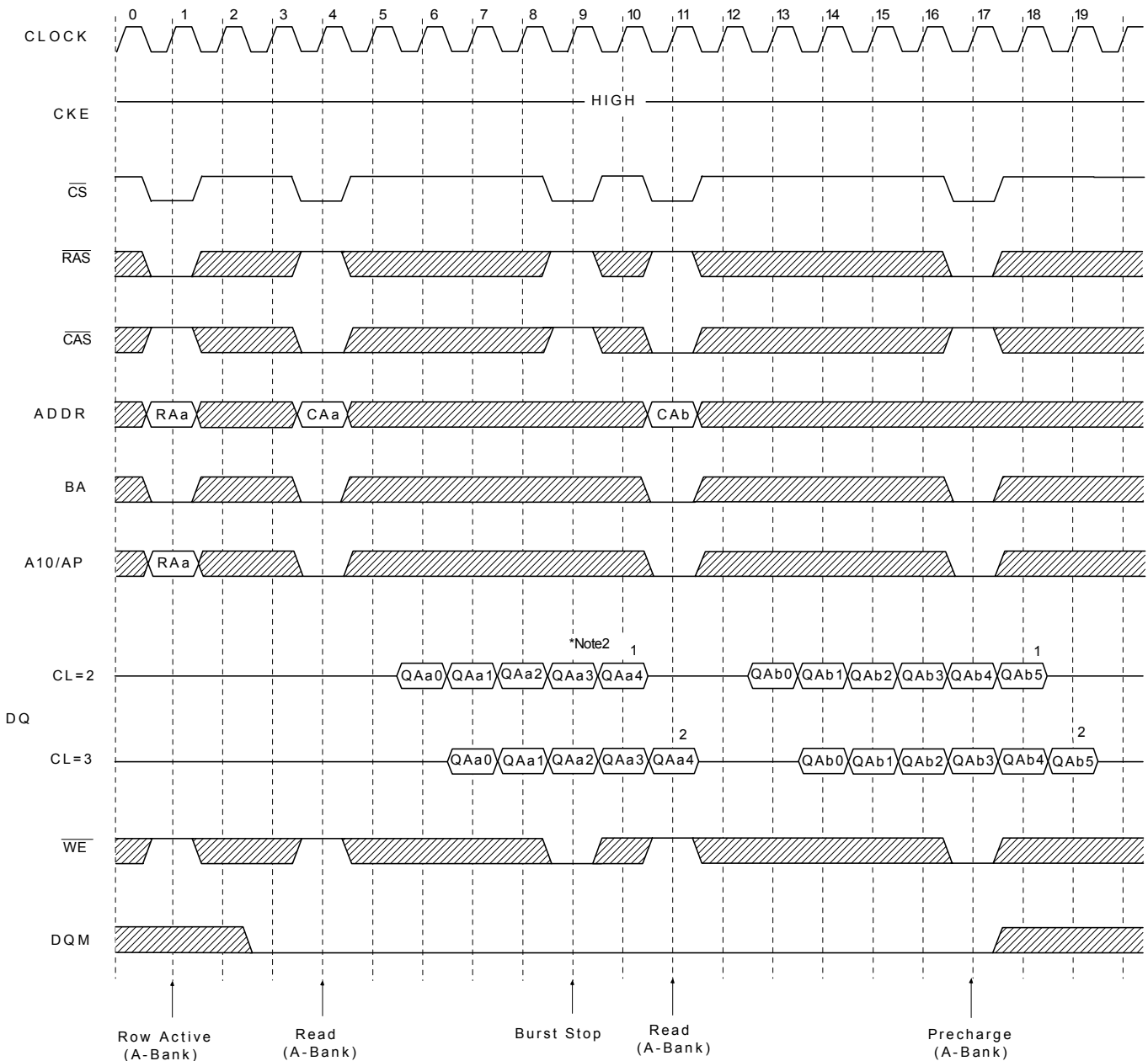

:Don't Care

***Note:** 1. Burst can't end in full page mode, so auto precharge can't issue.

2. About the valid DQs after burst stop, it is same as the case of $\overline{\text{RAS}}$ interrupt.

Both cases are illustrated above timing diagram. See the label 1,2 on them.

But at burst write, burst stop and $\overline{\text{RAS}}$ interrupt should be compared carefully.

Refer the timing diagram of "Full page write burst stop cycle".

3. Burst stop is valid at every burst length.

Write Interrupted by Precharge Command & Write Burst stop Cycle @ Burst Length =Full page

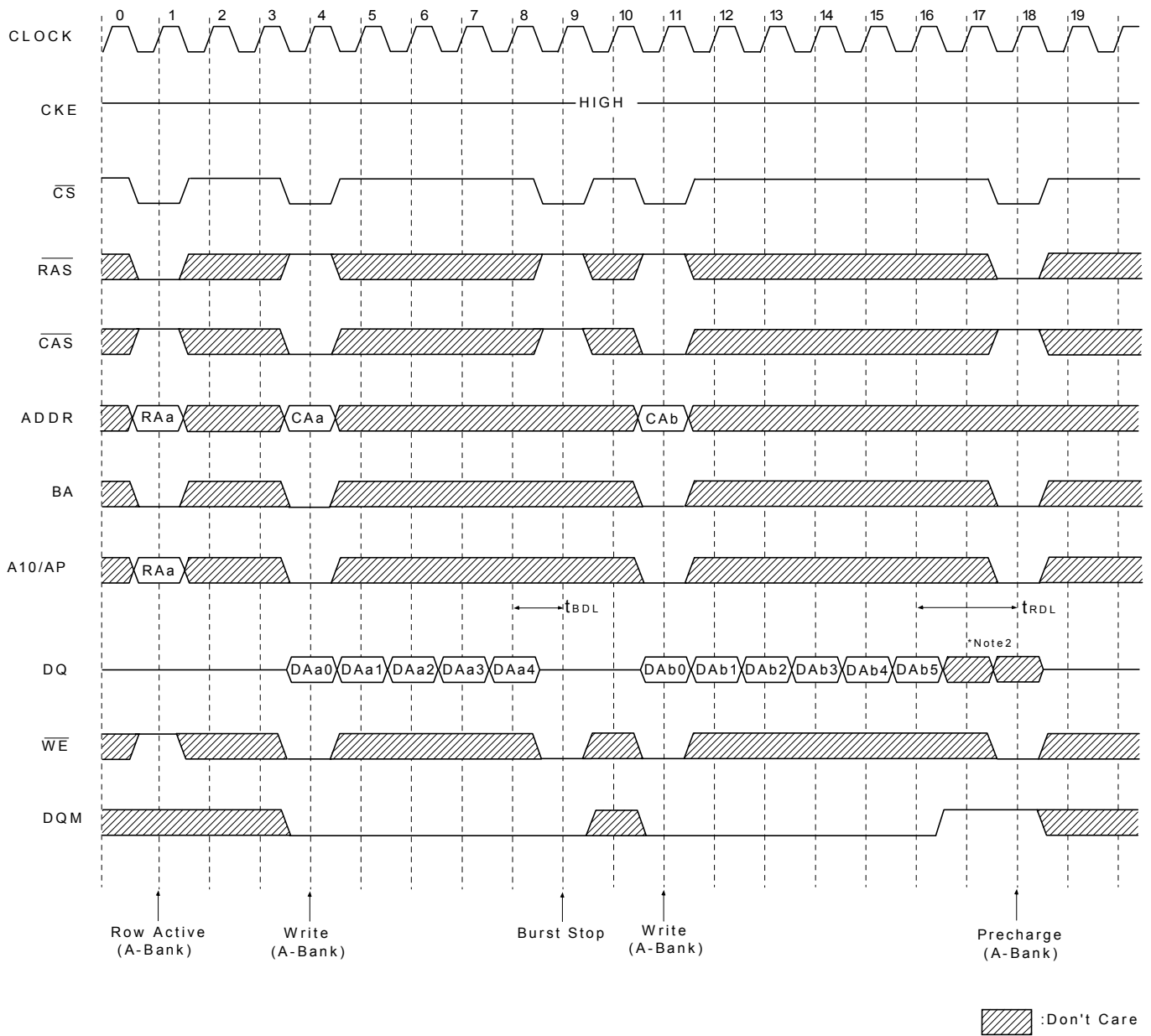

***Note:** 1. Burst can't end in full page mode, so auto precharge can't issue.

2. Data-in at the cycle of interrupted by precharge can not be written into the corresponding memory cell. It is defined by AC parameter of t_{RDL} .

DQM at write interrupted by precharge command is needed to prevent invalid write.

Input data after Row precharge cycle will be masked internally.

3. Burst stop is valid at every burst length.

Burst Read Single bit Write Cycle @Burst Length=2

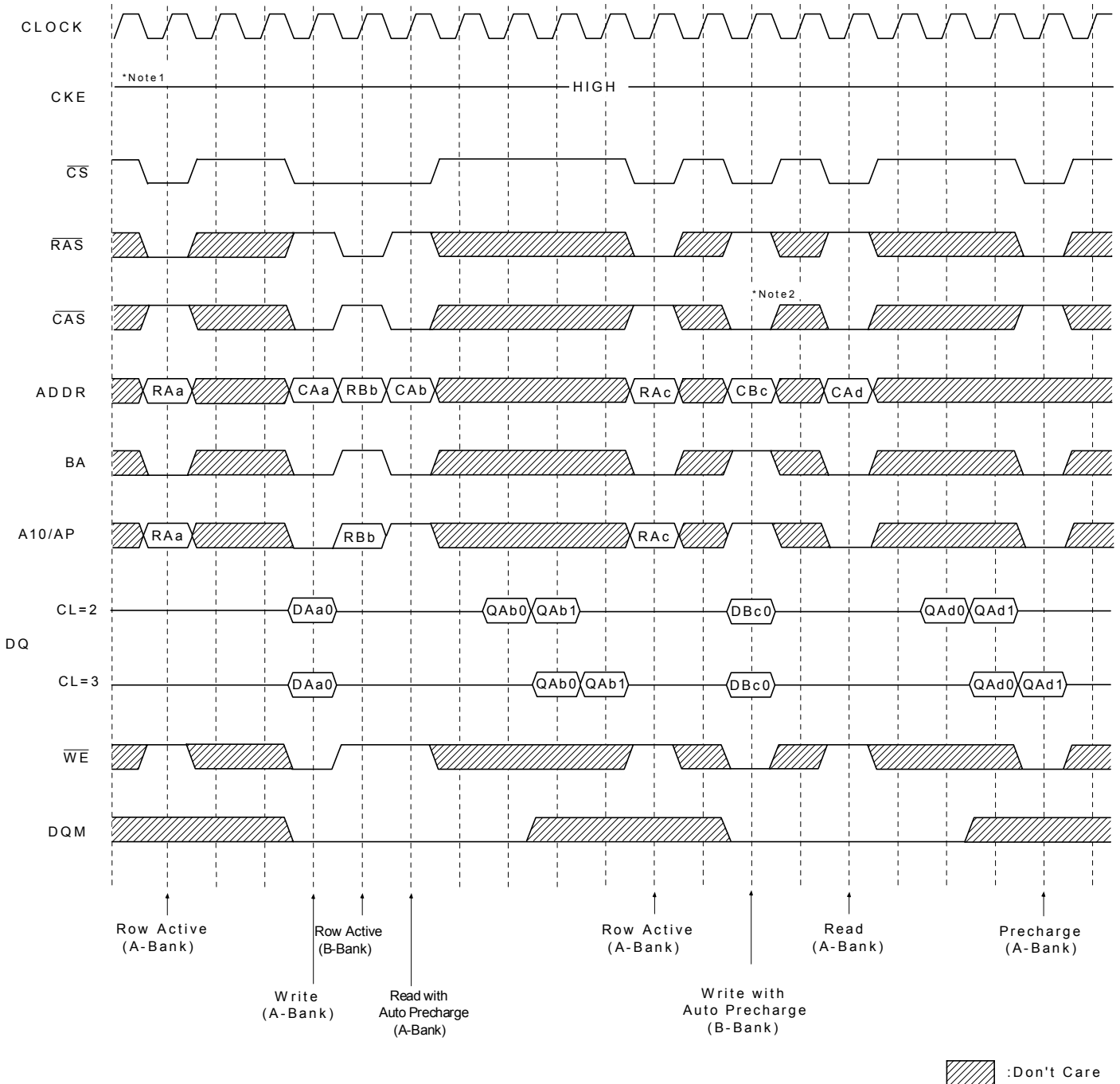

*Note:1.BRSW modes is enabled by setting A9 "High" at MRS(Mode Register Set).

At the BRSW Mode, the burst length at write is fixed to "1" regardless of programmed burst length.

2.When BRSW write command with auto precharge is executed, keep it in mind that t_{RAS} should not be violated.

Auto precharge is executed at the next cycle of burst-end, so in the case of BRSW write command, the precharge command will be issued after two clock cycles.

Active/Precharge Power Down Mode @CAS Latency=2, Burst Length=4

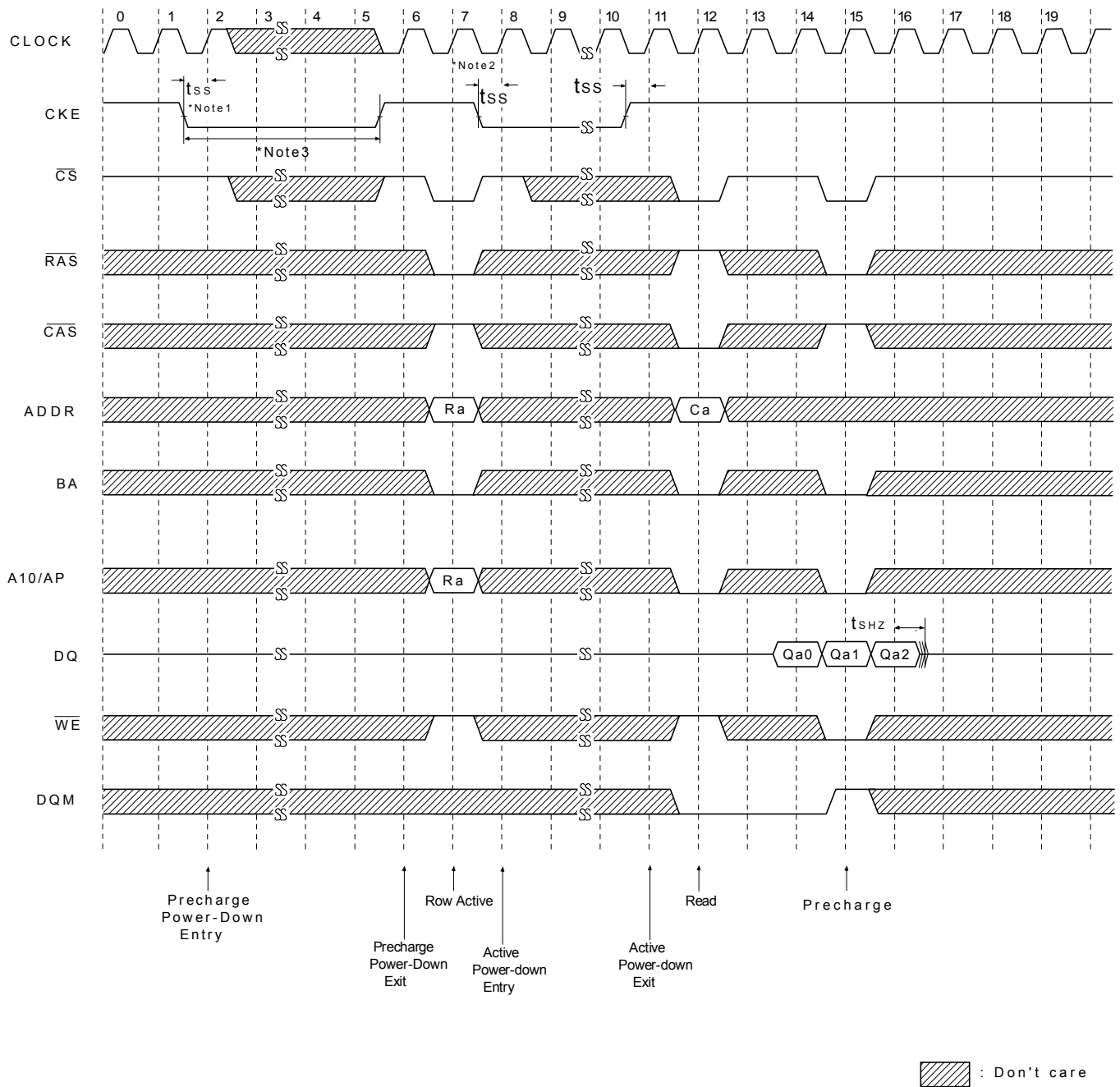

- *Note :1.Both banks should be in idle state prior to entering precharge power down mode.
- 2.CKE should be set high at least $1CLK+t_{SS}$ prior to Row active command.
- 3.Can not violate minimum refresh specification. (32ms)

Self Refresh Entry & Exit Cycle

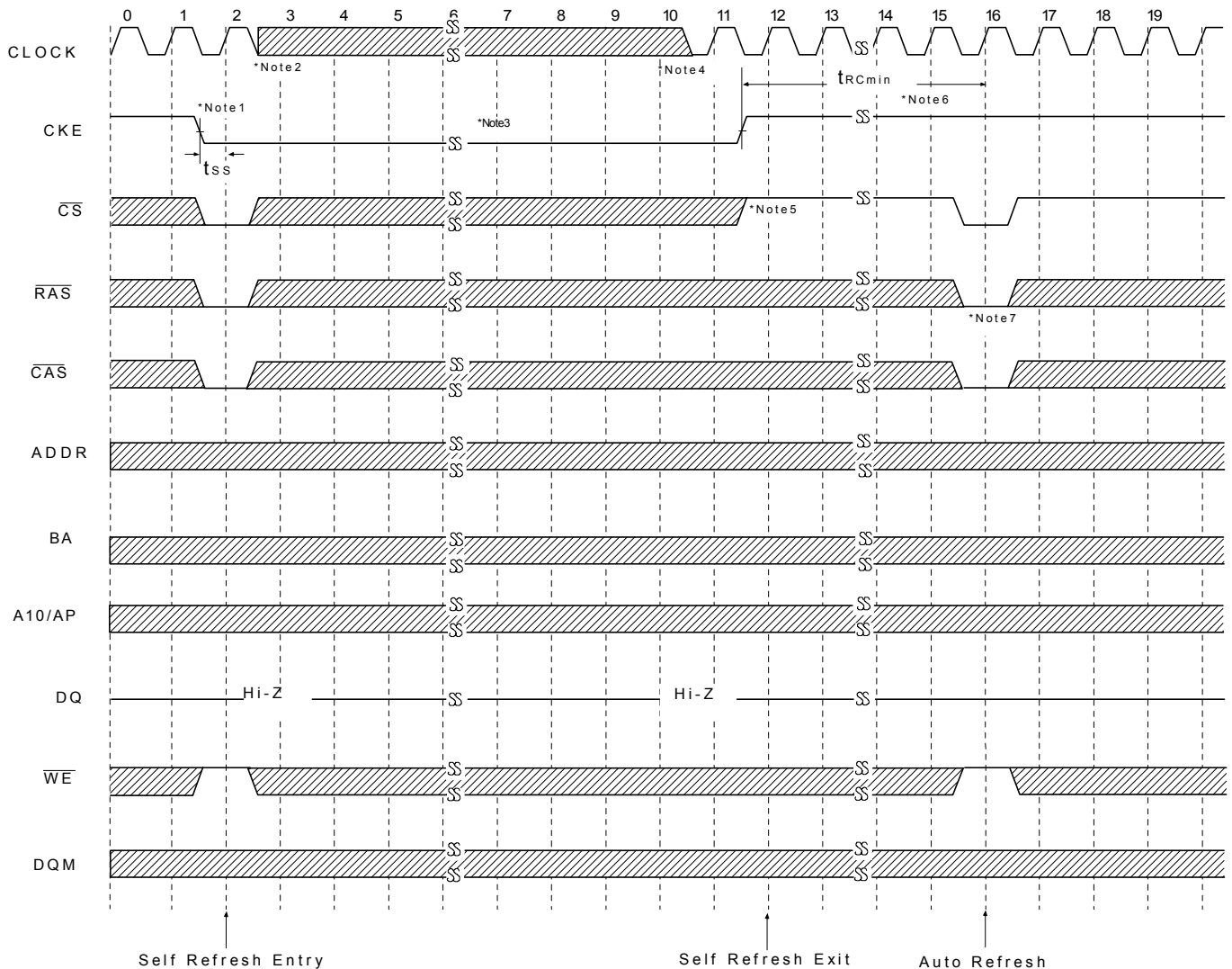

 : Don't care

*Note: TO ENTER SELF REFRESH MODE

1. \overline{CS} , \overline{RAS} & \overline{CAS} with CKE should be low at the same clock cycle.
2. After 1 clock cycle, all the inputs including the system clock can be don't care except for CKE.
3. The device remains in self refresh mode as long as CKE stays "Low".
cf.) Once the device enters self refresh mode, minimum t_{RAS} is required before exit from self refresh.

TO EXIT SELF REFRESH MODE

4. System clock restart and be stable before returning CKE high.
5. \overline{CS} Starts from high.
6. Minimum t_{RC} is required after CKE going high to complete self refresh exit.
7. 2K cycle of burst auto refresh is required before self refresh entry and after self refresh exit if the system uses burst refresh.

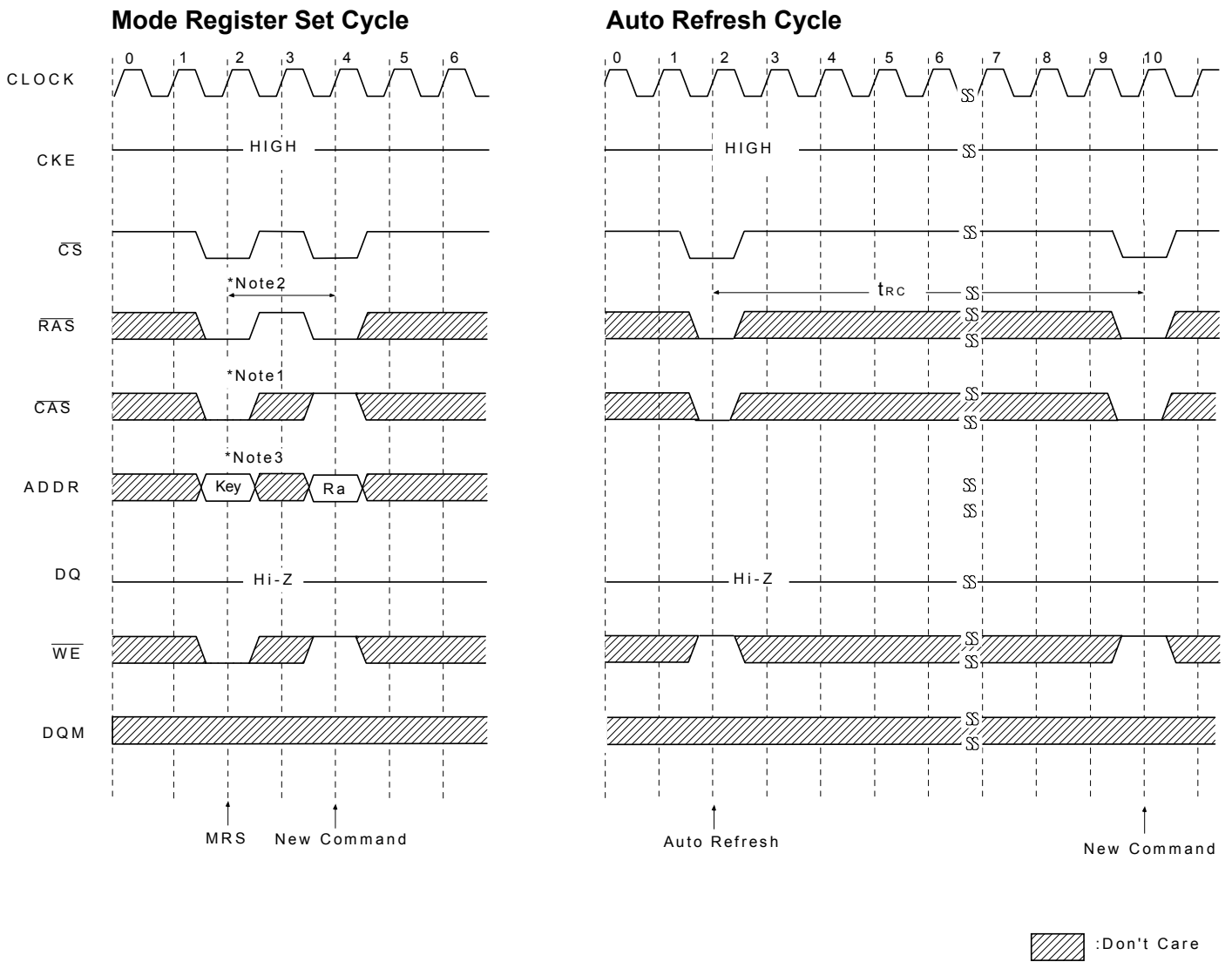

*Both banks precharge should be completed before Mode Register Set cycle and auto refresh cycle.

MODE REGISTER SET CYCLE

*Note: 1. \overline{CS} , \overline{RAS} , \overline{CAS} & \overline{WE} activation at the same clock cycle with address key will set internal mode register.

2. Minimum 2 clock cycles should be met before new \overline{RAS} activation.

3. Please refer to Mode Register Set table.

PACKAGE DIMENSIONS

50-LEAD TSOP(II) SDRAM(400mil)

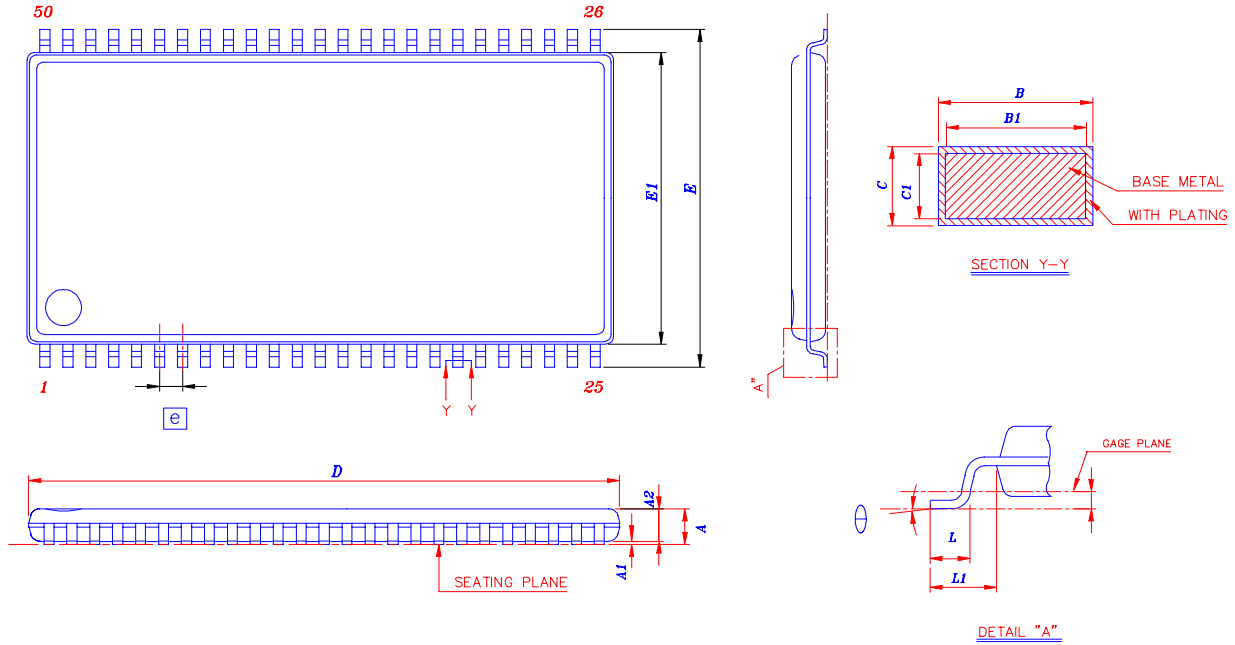

Symbol	Dimension in mm			Dimension in inch		
	Min	Nom	Max	Min	Nom	Max
A	-	-	1.20	-	-	0.047
A1	0.051	0.127	0.203	0.002	0.005	0.008
A2	0.95	1.00	1.05	0.037	0.039	0.041
B	0.30	-	0.45	0.012	-	0.018
B1	0.30	0.35	0.40	0.012	0.014	0.016
C	0.12	-	0.21	0.005	-	0.008
C1	0.10	0.127	0.16	0.004	0.005	0.006
D	20.82	20.95	21.08	0.820	0.825	0.830
E	11.56	11.76	11.96	0.455	0.463	0.471
E1	10.03	10.16	10.29	0.394	0.400	0.405
L	0.40	0.50	0.60	0.016	0.020	0.024
L1	0.80 REF			0.031 REF		
e	0.80 BSC			0.031 BSC		
θ	0	-	8	0	-	8

PACKING DIMENSIONS
60-BALL SDRAM (6.4x10.1 mm)

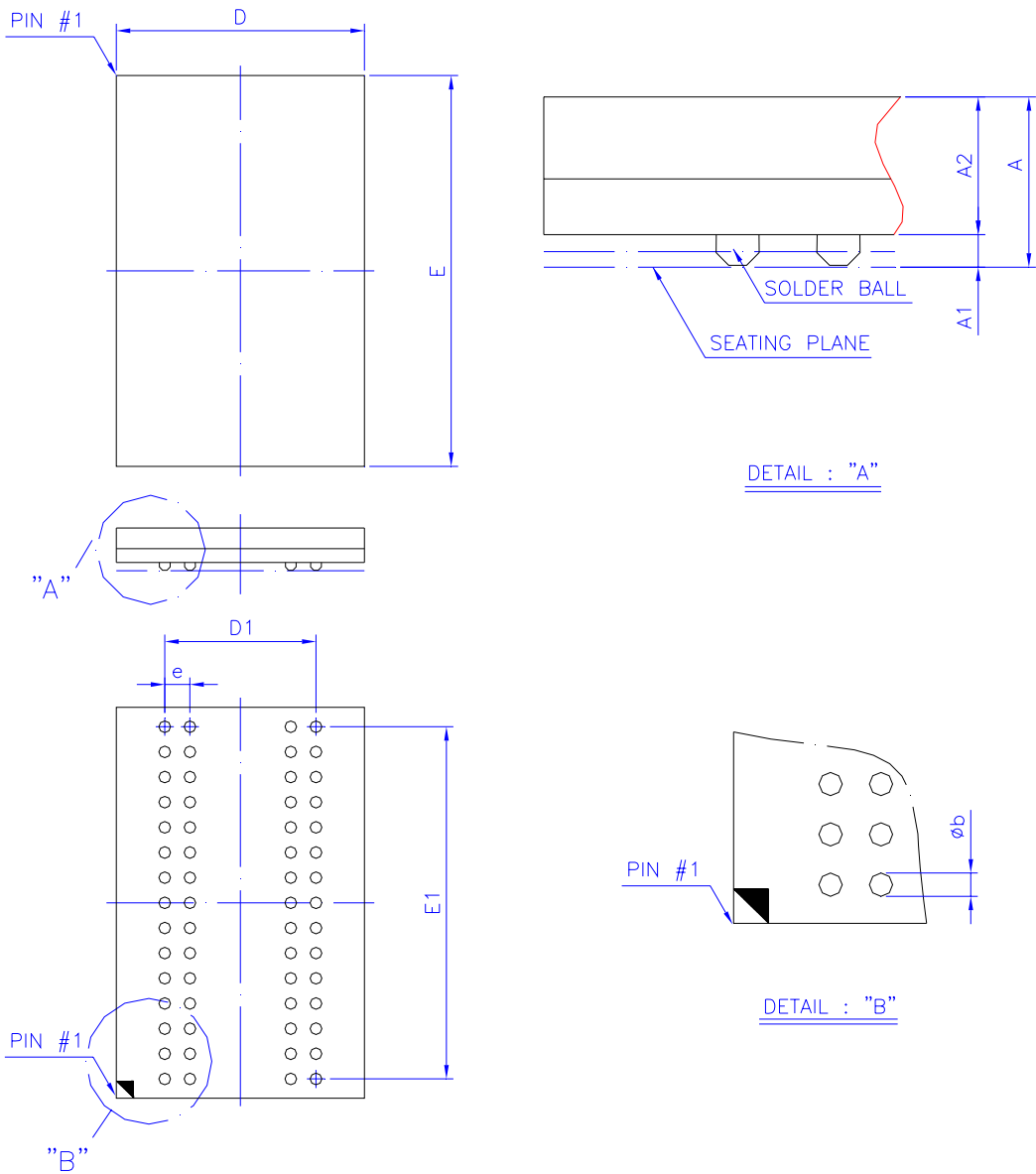

Symbol	Dimension in mm			Dimension in inch		
	Min	Norm	Max	Min	Norm	Max
A	—	—	1.00	—	—	0.039
A ₁	0.20	0.25	0.30	0.008	0.010	0.012
A ₂	0.61	0.66	0.71	0.024	0.026	0.028
Φ_b	0.30	0.35	0.40	0.012	0.014	0.016
D	6.30	6.40	6.50	0.248	0.252	0.256
E	10.00	10.10	10.20	0.394	0.398	0.402
D ₁	—	3.90	—	—	0.154	—
E ₁	—	9.10	—	—	0.358	—
e	—	0.65	—	—	0.026	—

Controlling dimension : Millimeter.

Important Notice

All rights reserved.

No part of this document may be reproduced or duplicated in any form or by any means without the prior permission of ESMT.

The contents contained in this document are believed to be accurate at the time of publication. ESMT assumes no responsibility for any error in this document, and reserves the right to change the products or specification in this document without notice.

The information contained herein is presented only as a guide or examples for the application of our products. No responsibility is assumed by ESMT for any infringement of patents, copyrights, or other intellectual property rights of third parties which may result from its use. No license, either express, implied or otherwise, is granted under any patents, copyrights or other intellectual property rights of ESMT or others.

Any semiconductor devices may have inherently a certain rate of failure. To minimize risks associated with customer's application, adequate design and operating safeguards against injury, damage, or loss from such failure, should be provided by the customer when making application designs.

ESMT's products are not authorized for use in critical applications such as, but not limited to, life support devices or system, where failure or abnormal operation may directly affect human lives or cause physical injury or property damage. If products described here are to be used for such kinds of application, purchaser must do its own quality assurance testing appropriate to such applications.