



---

**C168 VHF Handy Transceiver**  
**C468 UHF Handy Transceiver**

---

**OWNER'S MANUAL**

**STANDARD COMMUNICATIONS**  
A DIVISION OF MARANTZ JAPAN INC.

Downloaded by   
  
**Amateur Radio Directory**

# Contents

Thank you for purchasing the C168/C468 Handy FM Transceiver.

This product was manufactured and shipped under the strictest component control and inspection procedures to ensure top quality. If, however, any malfunction should occur, please contact your dealer immediately.

- Please read this owner's manual through completely before using the unit to allow you to make the most of its many features. Store it together with the warranty card in a safe place.
- This owner's manual covers both the C168 and C468. The description centers on the C468.

Packing Diagram .....	2
Accessories (Optional) .....	2
Before Using the Unit .....	3
Setup .....	4 ~ 7
Overview of C168/C468 Functions and Operation .....	8 ~ 11
Operation and Functions of Parts .....	12 ~ 20
Repeater Operation .....	21 ~ 25
Paging Operation .....	26 ~ 31
Code Squelch Operation .....	32
Tone Squelch Operation .....	33
Memory Operation .....	34 ~ 38
Scan Operation .....	39 ~ 44
Call Operation .....	45
Dual Watch Operation .....	46, 47
DTMF Operation .....	48, 49
Additional Functions .....	50 ~ 61
Functions Accessed by Holding Down the FUNC Key and Pressing Another Key .....	50 ~ 52
Functions Accessed by Pressing Numeric Keys in the Set Mode .....	53 ~ 55
Functions Accessed in the Set Mode by Holding Down the FUNC Key and Pressing Another Key .....	56 ~ 58
Extra Mode .....	59 ~ 61
Troubleshooting .....	62, 63
Specifications .....	64

# Packing Diagram

# Accessories (Optional)

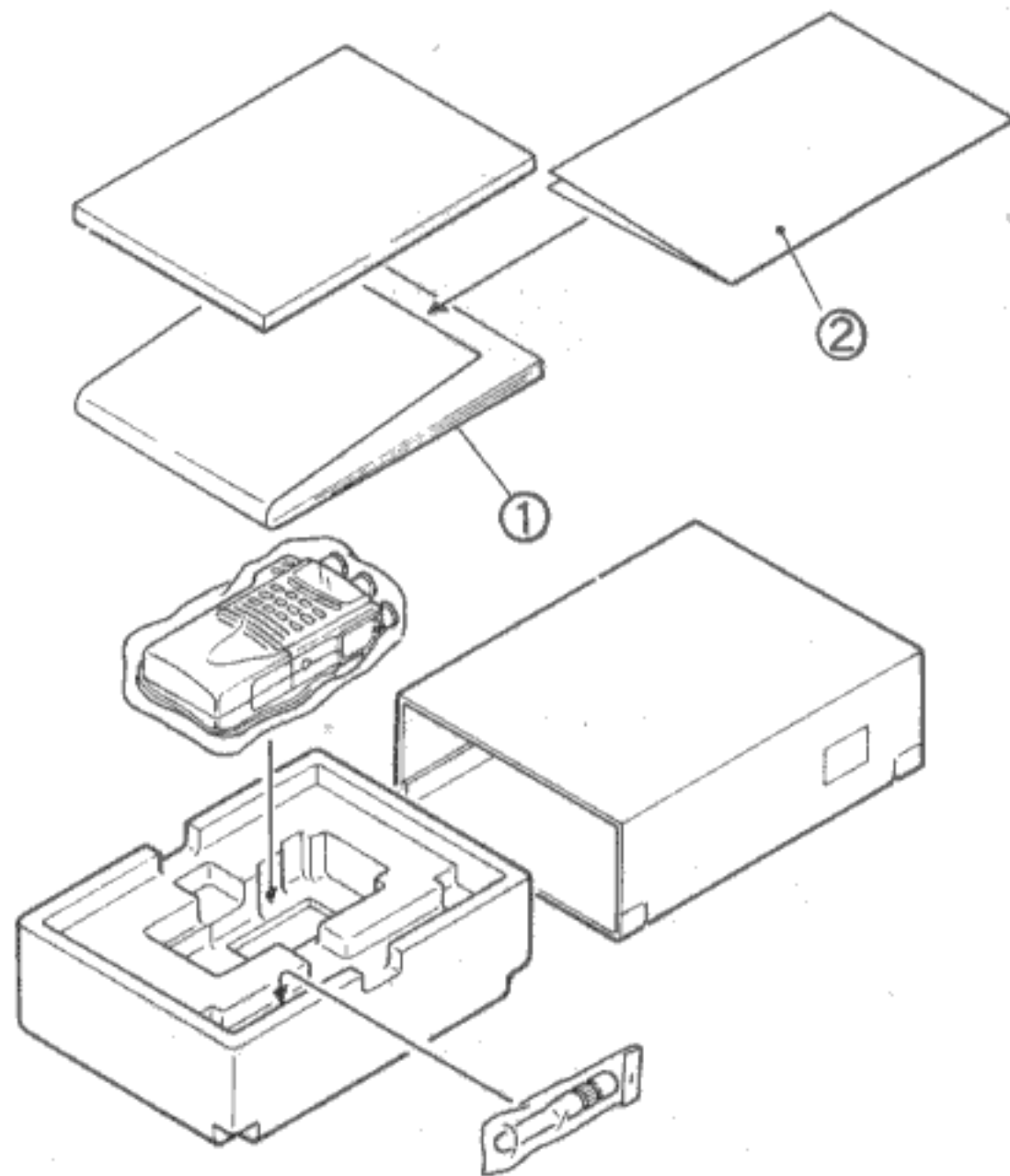

- ① Owner's manual
- ② Circuit diagram

A wide range of accessories is available to enable you to make the most of the C168/C468. Before using any of the accessories listed, please read the owner's manual that came with it carefully.

Model number	Description
CBT160	Battery case (holds 5 AA batteries)
CNB160	Compact rechargeable battery pack (6 V, 300 mAh)
CNB161	Standard rechargeable battery pack (7.2 V, 700 mAh)
CNB162	High-power rechargeable battery pack (12 V, 600 mAh)
CNB163	Long-life rechargeable battery pack (7.2 V, 1,000 mAh)
CSA160E	Desktop charger (quick charger) (Works with all models in the CNB160 Series.)
CMC150	Mobile charger (CNB160/161/163)
CCA160	Charger adaptor
CWC150K	AC charger (CNB160/161/163)
CWC151K	AC charger (CNB162)
CAX03	Transceiver bottom cover
CAX160	Remote battery adaptor
CMB111	Mobile bracket
CAW150	Mobile power supply cable
CAW151	Base station power supply cable
CBH160	Molded clip
CLC160	Soft case (CNB160)
CLC161	Soft case (CNB161/CBT160)
CLC162	Soft case (CNB162/CNB163)
CTN160	CTCSS (tone squelch) unit
CMU160	Memory unit (40-channel memory)
CMU161	Memory unit (100-channel memory x 2)
CMP111	Microphone-speaker combination
CMP115	Compact microphone-speaker combination
CMP113	Tiepin microphone
CHP111	Headset with PTT switch
CHP150	Headset with VOX

# Before Using the Unit (Observe the Following Precautions)

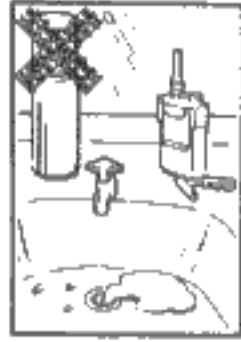

Avoid wet or humid places.



Avoid exposing the unit to excessive vibrations.



Avoid very dusty places.



Avoid hot places and locations exposed to direct sunlight.

## Do not disassemble the unit.

- Never touch the unit's cores or trimmers. They are already adjusted for optimum performance.

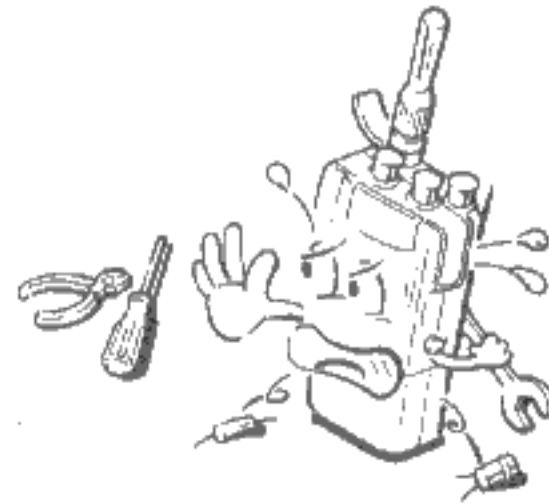

## The unit will not operate on a 24 V power supply.

- The unit's operating voltage range is 6.0 ~ 16.0 V. Never connect the unit to an external power supply outside of this range. Doing so could cause permanent damage to the unit.

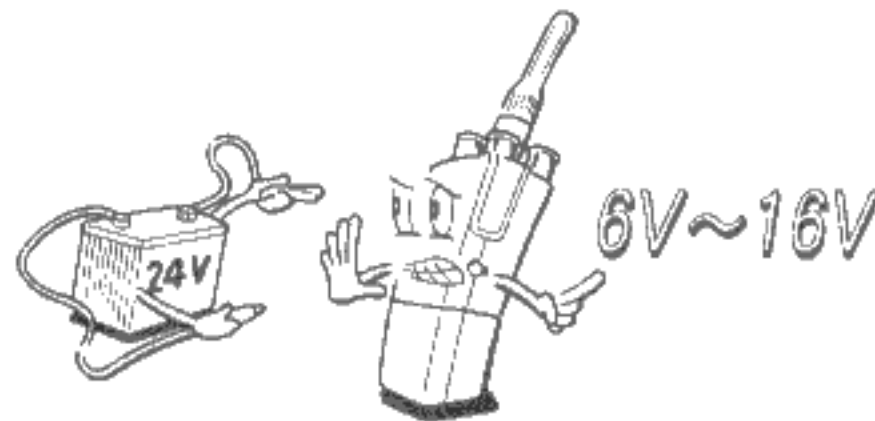

## Batteries

- Make sure the (+) and (-) ends of the batteries are oriented correctly.

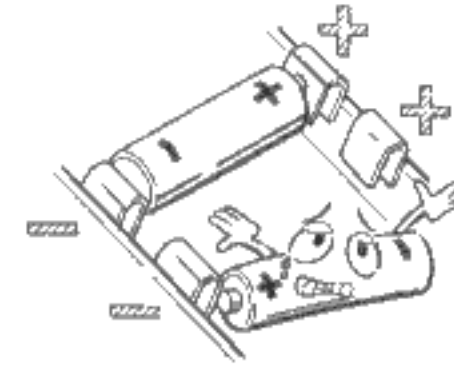

- Never use new and old batteries together.



- Never expose old batteries to an open flame.



## Suitable batteries

- SUM-3 magnesium batteries
- Alkaline batteries
- Nickel-cadmium batteries (Some types are not compatible.)

# Setup

## 1 Attaching the antenna

- Attach the included antenna to the antenna terminal.

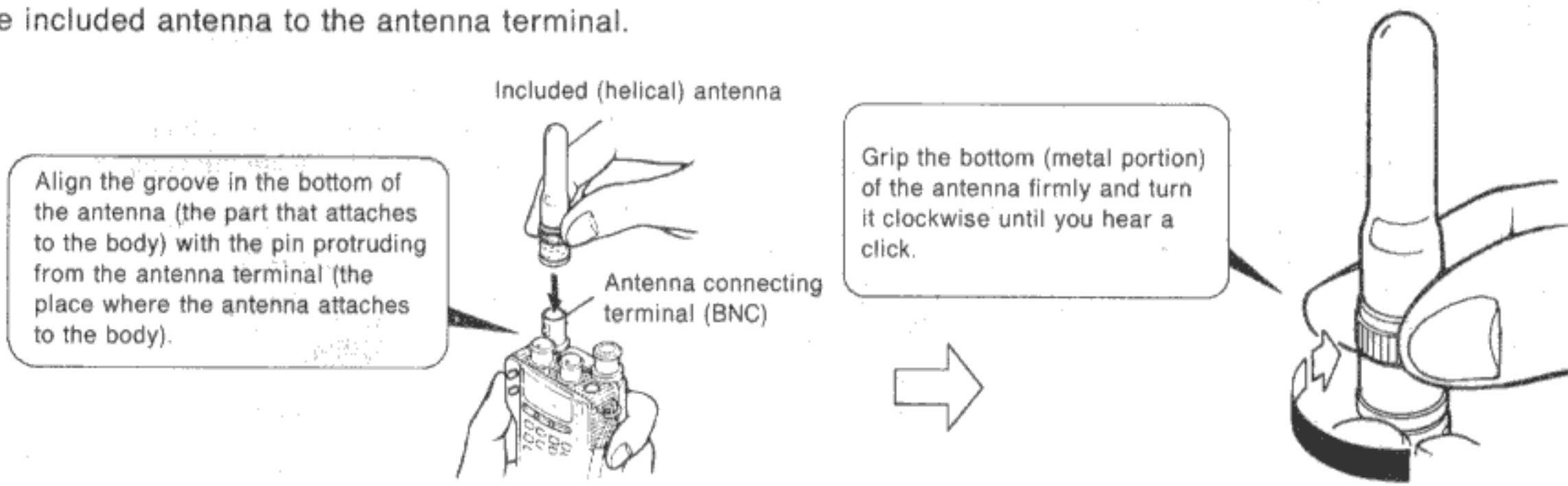

## 2 Battery insertion

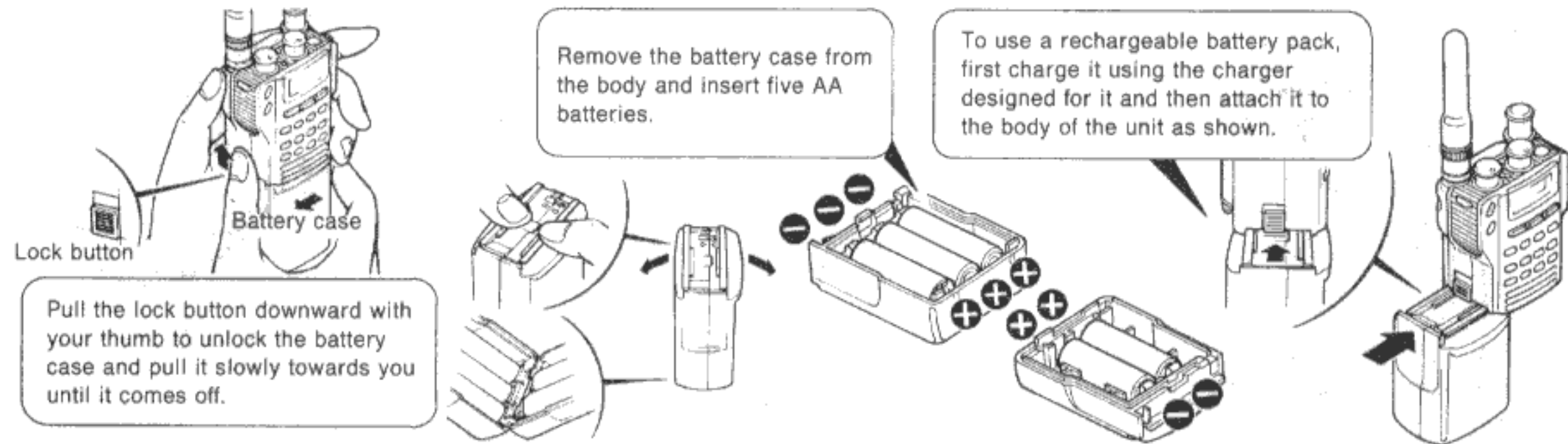

### 3 Switching power on and adjusting the volume

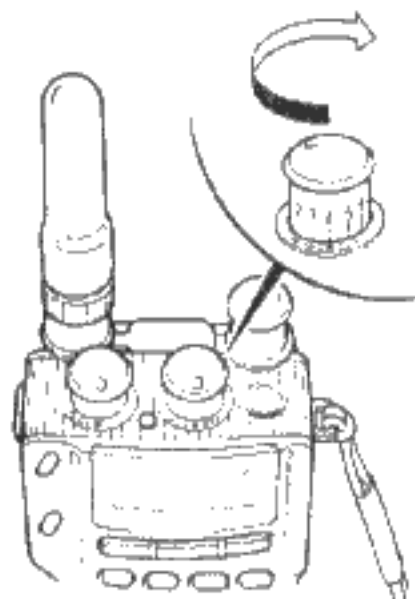

Turn the volume knob clockwise until it clicks to switch power on.



Volume knob



Turn the volume knob further clockwise to increase the volume.



### 4 Squelch adjustment

- How to eliminate background hiss

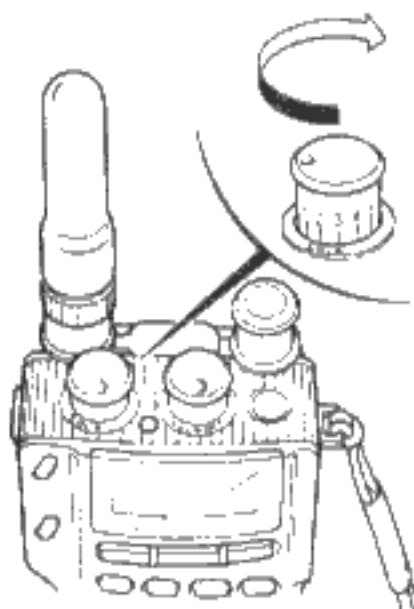

Turn the squelch knob clockwise until background hiss is no longer audible.

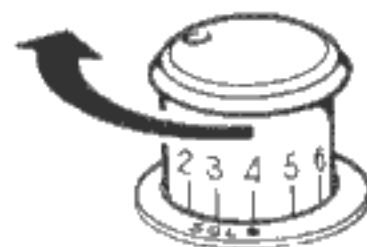

**NOTE**

*It may be difficult to receive weak signals if the squelch knob is turned too far clockwise.*

Stop turning the knob as soon as background hiss is inaudible.



## 5 Setting the frequency

- There are three ways to set the frequency

### ADVICE

The transceiver continues to operate at the old frequency setting while the new one is being input.

### Setting the frequency using the numeric keys

Setting the frequency to 433.06 MHz.

### PROCEDURE

- 1) Press the [3] key to input the 1 MHz column.

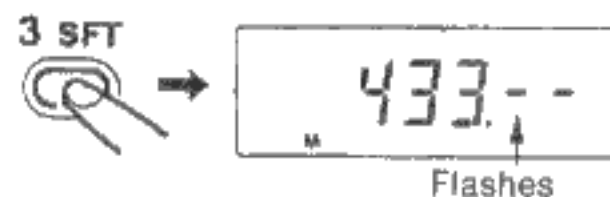

- 2) Press the [0] key to input the 100 kHz column.

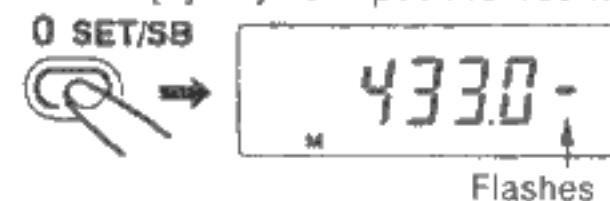

- 3) Press the [6] key to input the 10 kHz column.

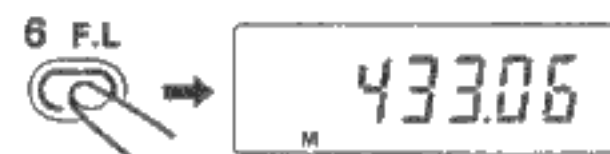

When setting is complete, a long high pitched beep (peep) sounds.

### Setting the frequency using the rotary channel selector

Turning the rotary channel selector causes the frequency to rise or fall in tuning steps of the preset size.

See page 51 for an explanation of tuning steps.

Frequency rises      Frequency falls

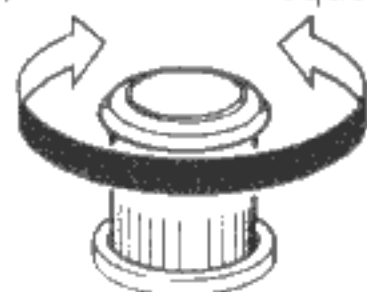

Rotary channel selector

### ADVICE

Turning the rotary channel selector with the FUNC key held down causes the frequency to rise or fall in 100 kHz tuning steps.

### Setting the frequency using the ▲/▼ keys

Press the ▲ key to raise the frequency setting and the ▼ key to lower it. The amount the frequency setting changes with each press depends on the tuning step setting.

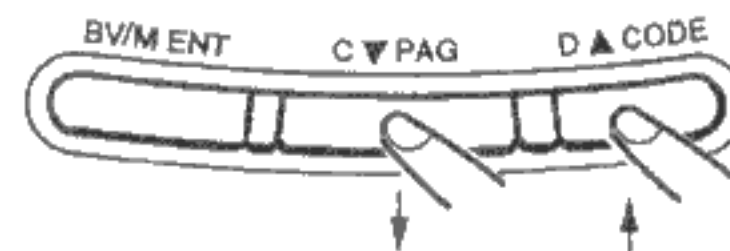

Frequency falls

Frequency rises

### ADVICE

Holding down the ▲/▼ keys for more than 0.5 seconds causes the frequency setting to change rapidly in the direction indicated.

## 6 Transmitting

- After setting the frequency and making sure that no other stations are broadcasting on it, press the PTT switch to transmit.

Hold down the PTT switch and speak into the microphone.

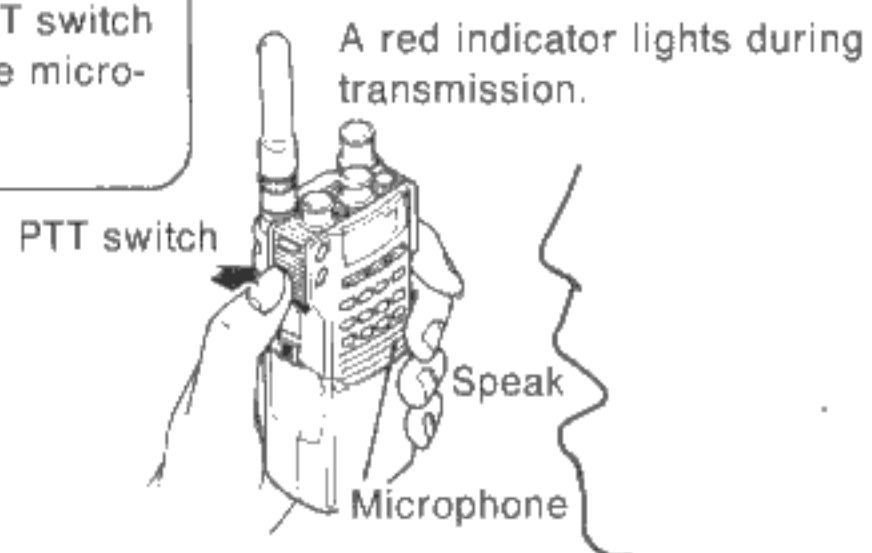

The transceiver automatically switches to the receive mode when the PTT switch is released.

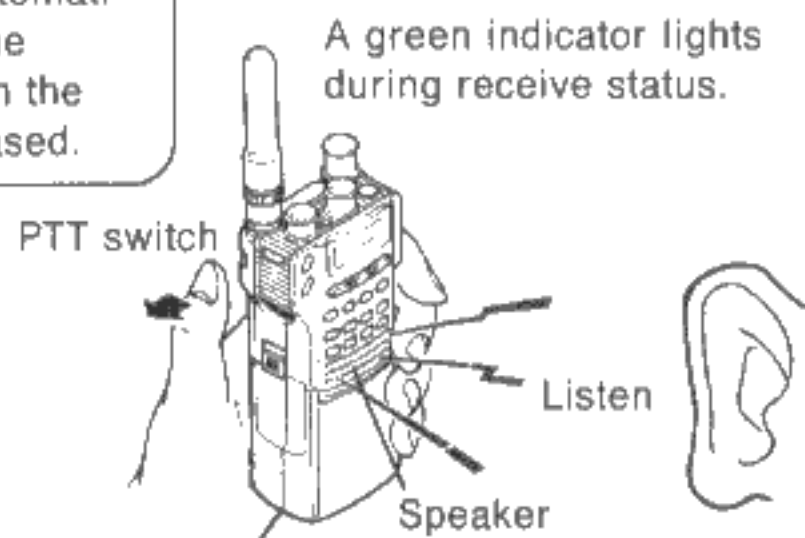

- A wide range of accessories is available to enable you to enjoy the C168/C468 in many different ways.

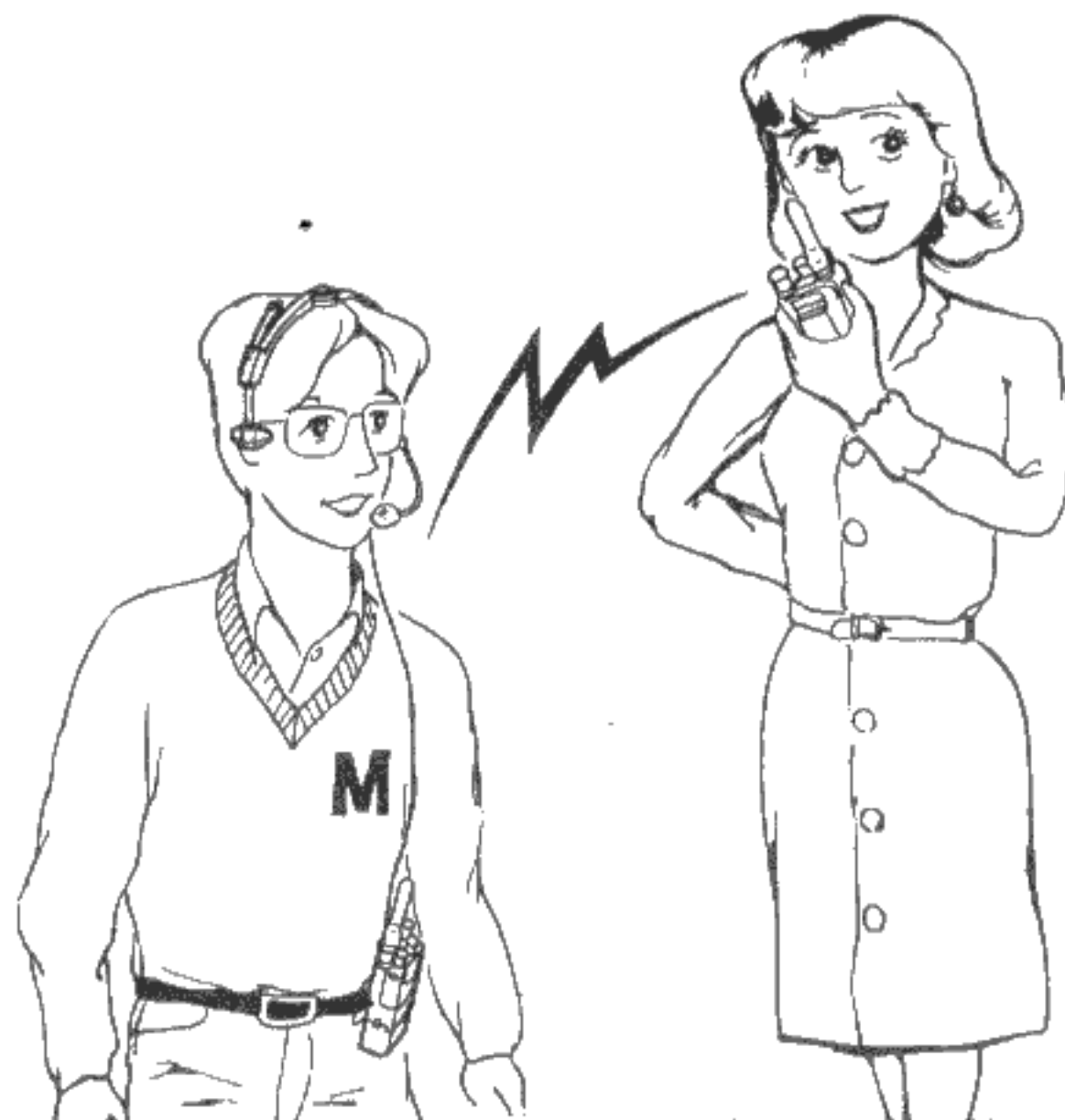



# Overview of C168/C468 Functions and Operation

## 1. Terminology

### 1 VFO mode

In the VFO mode the frequency setting is displayed and the M, C and DUAL indications are not displayed.

The VFO mode is active when the unit is first turned on (the factory setting).



### 2 Memory mode

In the memory mode the frequency setting and the memory address number are displayed.

In the VFO mode, press the B V/M ENT key to switch to the memory mode. (See pages 34 ~ 38.)

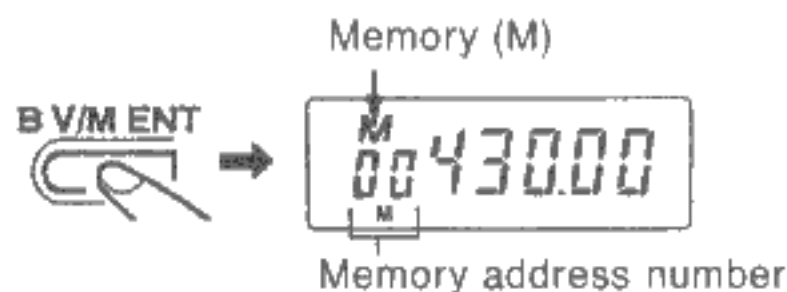

### 3 Dual watch mode

In the dual watch mode the DUAL indication is displayed.

See the dual watch operation section for details.

(See pages 46, 47.)



### 4 Call mode

In the call mode the C indication is displayed.

(See page 45.)

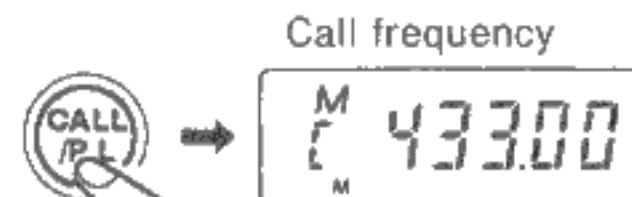

### 5 Set mode

In the set mode the SE indication is displayed.

(See pages 10 and 53 ~ 55.)



### 6 Extra mode

In the extra mode the EA indication is displayed.

(See pages 59 ~ 61.)

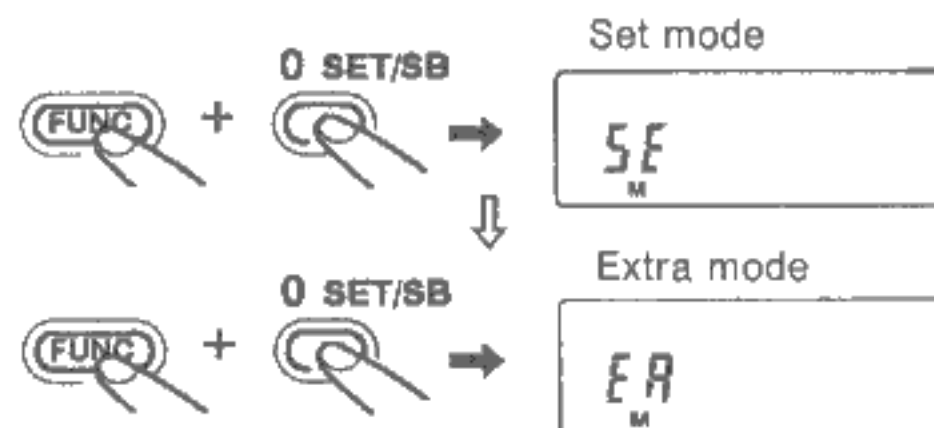

### 7 Paging mode

In the paging mode the PAG indication is displayed.

(See pages 26 ~ 31.)



## 2. C168/C468 basic functions

### 1) Functions accessed by pushing keys directly

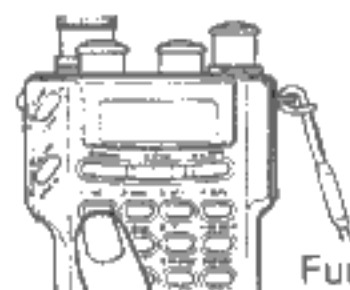

Functions printed in ivory

Key	Function	See page
0 ~ 9	Numeric input	6
LAMP	Display illumination ON/OFF	18
SQL OFF	Squelch control ON/OFF	19
V/M	VFO/memory mode toggle	36
▼	Frequency or address number down	6
▲	Frequency or address number up	6
# CL PS	Cancel mode	19
MS	Memory scan ON/OFF	41
CALL	Call up call frequency	45

### 2) Functions accessed by holding down the FUNC key and pressing another key

※ F + means "with the FUNC key held down."  
(See pages 50 ~ 52.)



Functions printed in light blue

Key	Function	See page
F + PO	Switch transmit power level	50
F + DUAL	Dual watch ON/OFF	46
F + SFT	Memory shift mode ON/OFF	38
F + STEP	Tuning step setting	51
F + SAVE	Save ON/OFF	51
F + F. L	Frequency lock ON/OFF	52
F + T. SQ/DM	Tone squelch/tone encoder toggle	33
F + PRT	Repeater mode ON/OFF	22
F + REV/HSC	Invert transmit and receive frequencies in repeater mode	23
F + SET/SB	Switch to set mode	11
F + L. LAMP	Turn lamp on	18
F + ENT	Switch memory record mode	34
F + PAG	Paging/code squelch ON/OFF	32
F + CODE	Code setting mode	27
F + MS. M	MS.M setting/MS.M operation	42
F + PS	Scan ON/OFF	40
F + CALL/P.L	PTT switch lock ON/OFF	52
F + DTMF. M	DTMF memory mode	48

3) Functions accessed by pressing numeric keys in the set mode.

The following functions are accessed by switching to the set mode and pressing the keys indicated.

(See pages 53 ~ 55.)

※ SE → means "press the following key while in the set mode."

- While holding down the FUNC key, press the 0 SET/SB key. The frequency indication disappears from the display. The [SE] (SET MODE) indication is displayed, showing that the set mode is active.



Key	Function	See page
SE → 0	Beep ON/OFF	53
SE → 1	Length of paging beep 1/5 toggle	53
SE → 2	1 kHz column input from numeric keys enable/disable toggle	53
SE → 3	Repeater + PAG transmission delay time	54
SE → 4	Squelch pop noise reduction	54
SE → 5	APO (Auto Power Off) ON/OFF	54
SE → 6	Enable encoder even in frequency lock status	55
SE → 7	CTCSS frequency setting mode (CTN160 tone frequency selection)	24
SE → 8	Repeater offset frequency setting	24
SE → 9	(Display indications appear normally, but no tones are produced internally.)	-

4) Functions accessed in the set mode by holding down the FUNC key and pressing another key.

(See pages 56 ~ 58.)

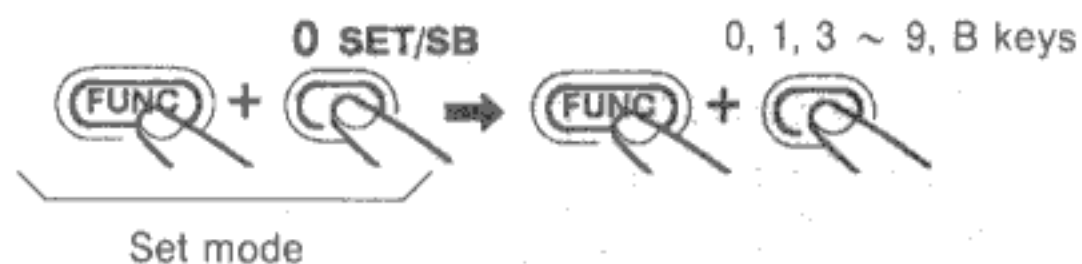

Key	Function	See page
SE → F + 1	All reset (restores factory settings)	56
SE → F + 2	Long medium pitched beep (boo) (no function)	-
SE → F + 3	All reset enable/prohibit toggle	56
SE → F + 4	Switch to protect mode	56
SE → F + 5	Squelch audio during paging even if code matches	57
SE → F + 6	Toggle tuning steps when rotary channel selector is turned with the FUNC key held down between 100 kHz and 1 MHz.	57
SE → F + 7	Clone mode	58
SE → F + 8	Long medium pitched beep (boo) (no function)	-
SE → F + 9	Switch bank of optional CMU161 memory unit	58
SE → F + B	Delete memory frequency	38
SE → F + 0	Switch to extra mode	11

5) Functions accessed by pressing keys in the extra mode

※ EA → means "press the following key while in the extra mode." (See pages 59 ~ 61.)

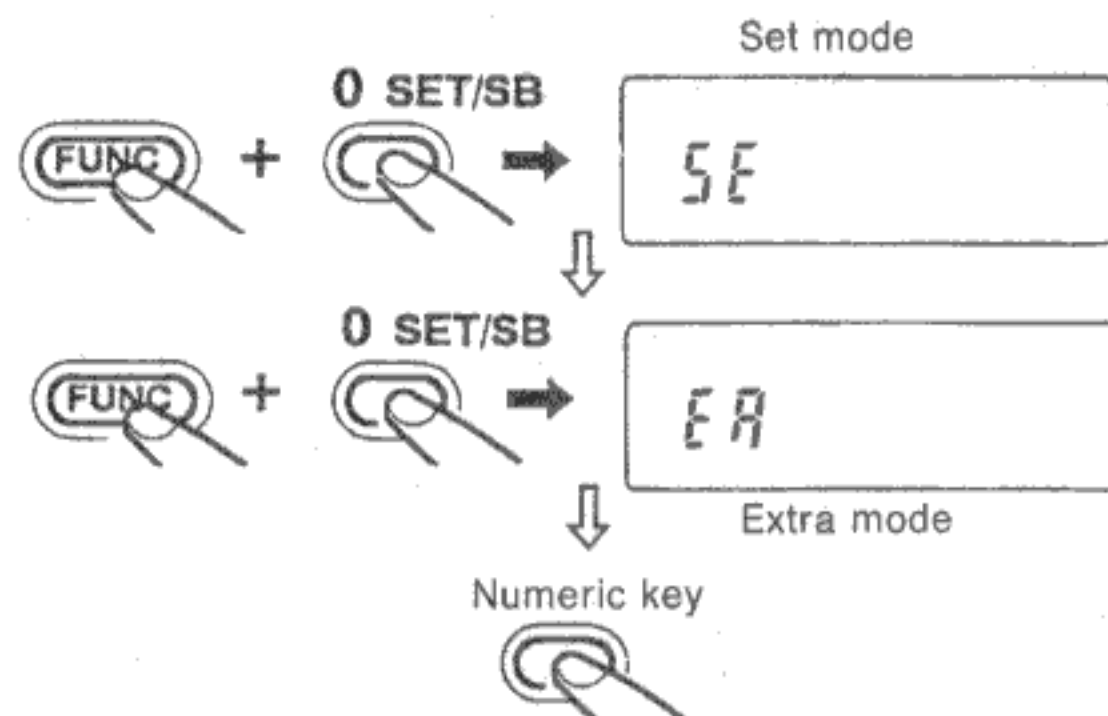

Key	Function	See page
EA → 1	High speed scan ON/OFF	59
EA → 2	High speed dual watch ON/OFF	59
EA → 3	Change LAMP key to REV key	25
EA → 4	Select interval for save function	60
EA → 5	Reduce DTMF transmission speed	60
EA → 6	Long medium pitched beep (boo) (no function)	-
EA → 7	Long medium pitched beep (boo) (no function)	-
EA → 8	Enable frequency input from 100 MHz column	61
EA → 9	Long medium pitched beep (boo) (no function)	-
EA → 0	Long medium pitched beep (boo) (no function)	-

# Operation and Functions of Parts

## Top View

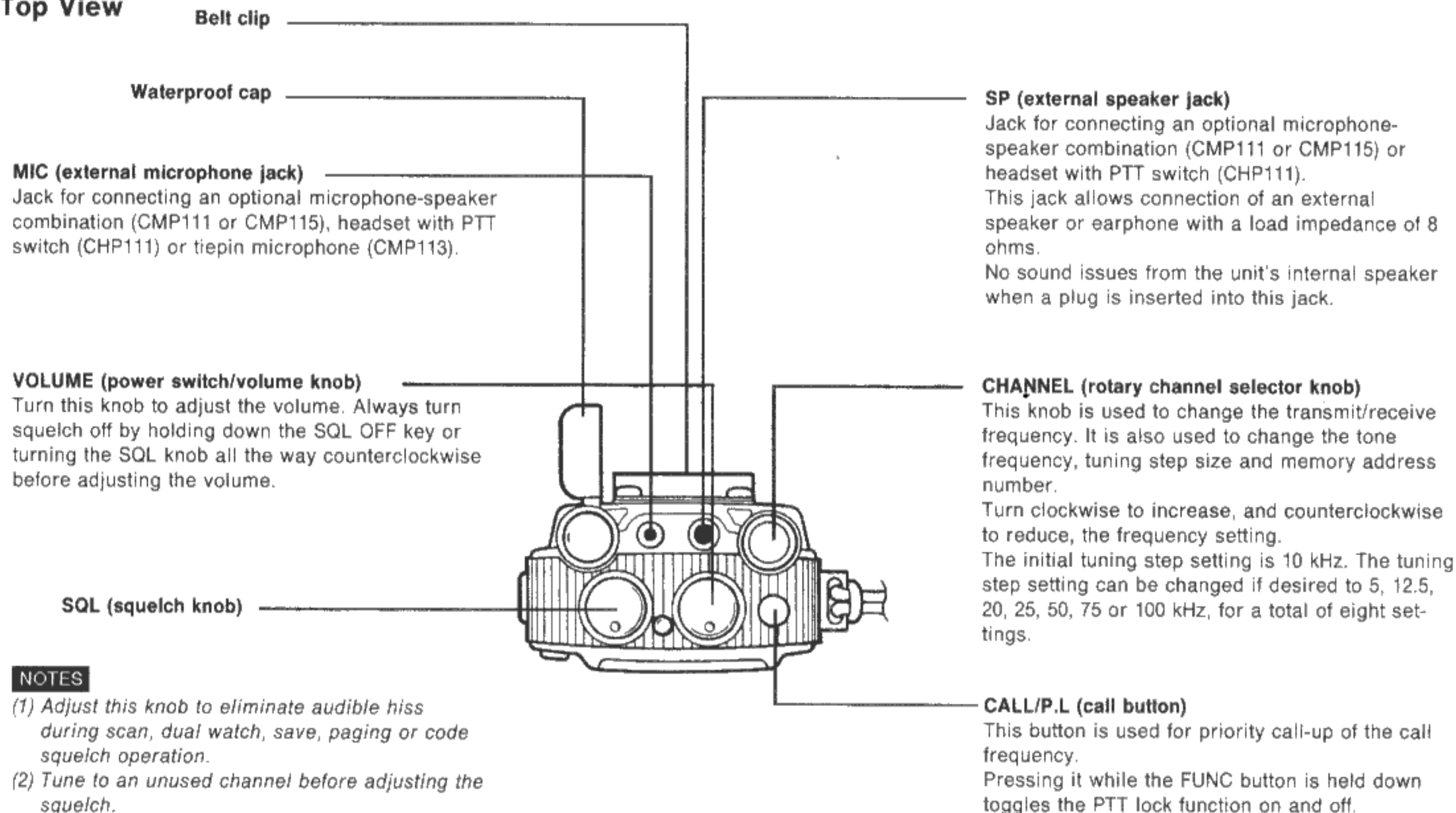

### NOTES

- (1) Adjust this knob to eliminate audible hiss during scan, dual watch, save, paging or code squelch operation.
- (2) Tune to an unused channel before adjusting the squelch.

## Front View

### FUNCTION (function)

A variety of special functions can be accessed by holding down this key and pressing another key.

### PTT switch

Switches between transmitting and receiving.

### SQL OFF (squelch off button)

Squelch is disabled for as long as this button is held down, regardless of the setting of the squelch knob. It has the same effect as turning the squelch knob all the way counterclockwise.

Pressing the SQL OFF button while the PTT switch is held down causes a DTMF signal to be transmitted.

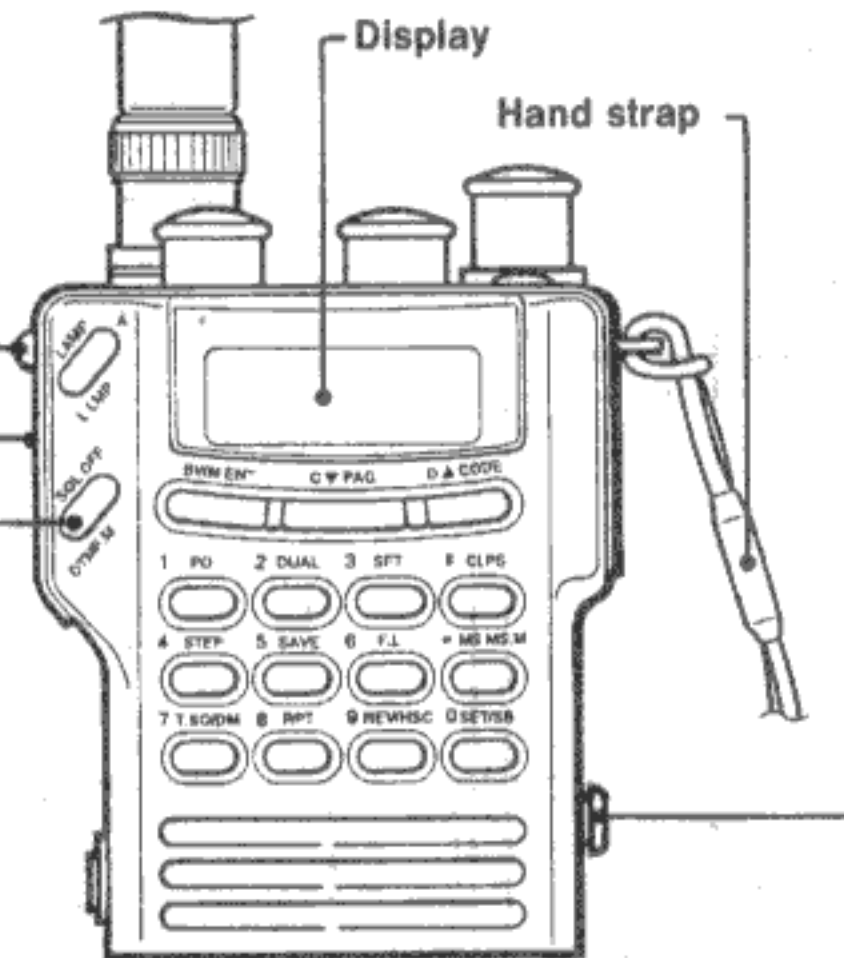

### DC IN (external power supply connector jack)

Plug the (optional) power supply cord into this jack. The unit switches automatically from the battery pack to the external power supply when the plug is inserted.

### Note:

The CAW150 has a special plug configuration. Do not use a power supply cable other than the CAW150 or CAW151 with the C168/C468.

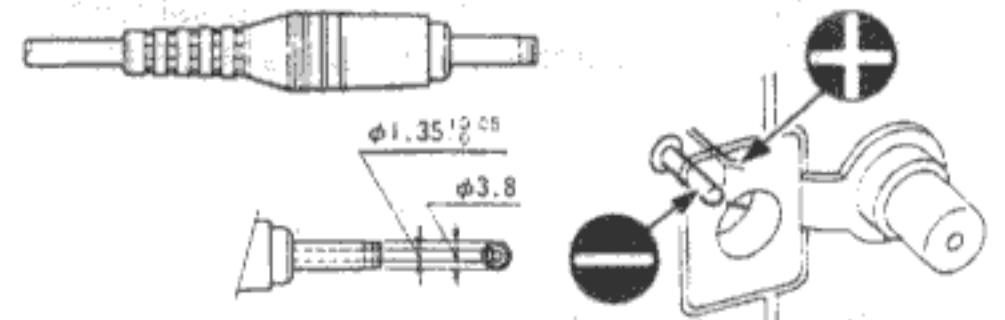

### NOTE

Always turn the power switch off before unplugging the power supply cable. The unit's operating voltage range is 6.0 ~ 16.0 V. Never connect it to an external power supply outside of this range.

## Front control panel (keys)

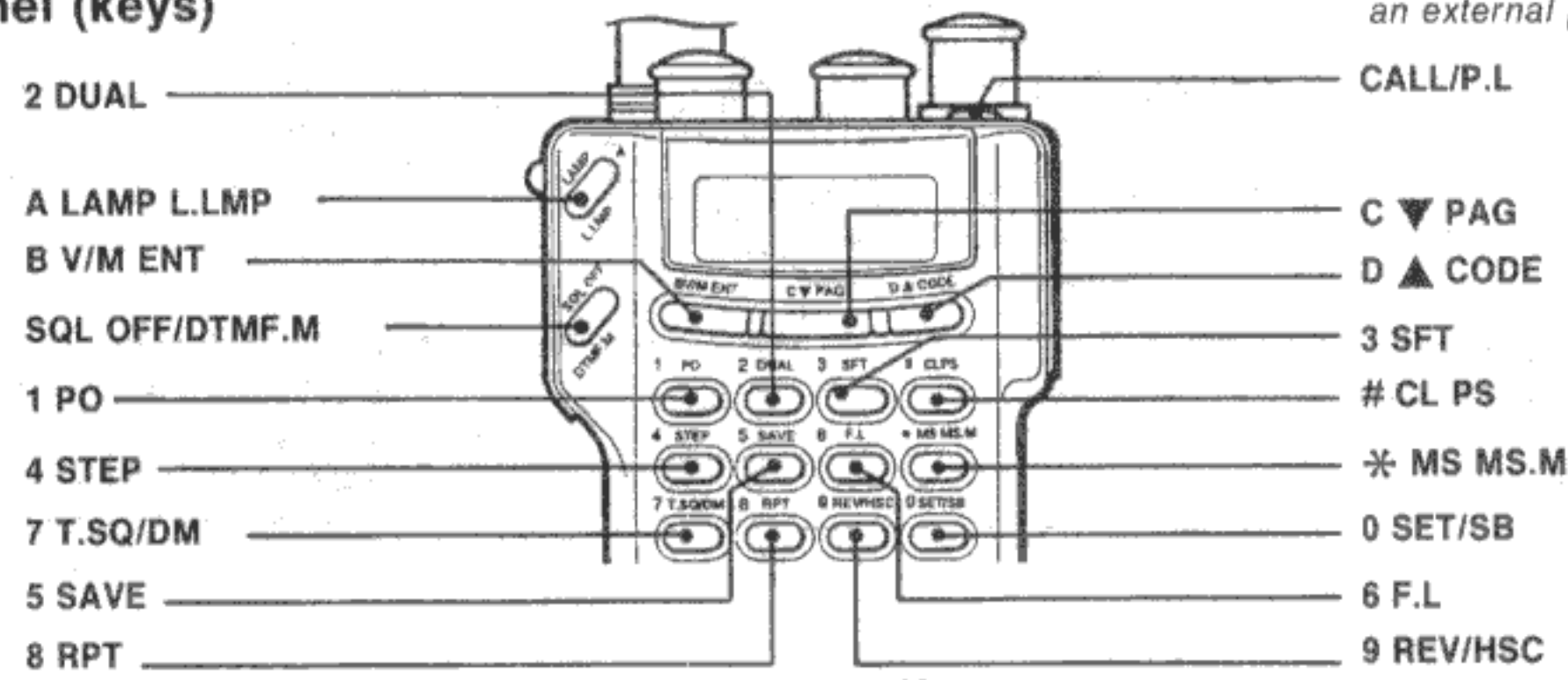

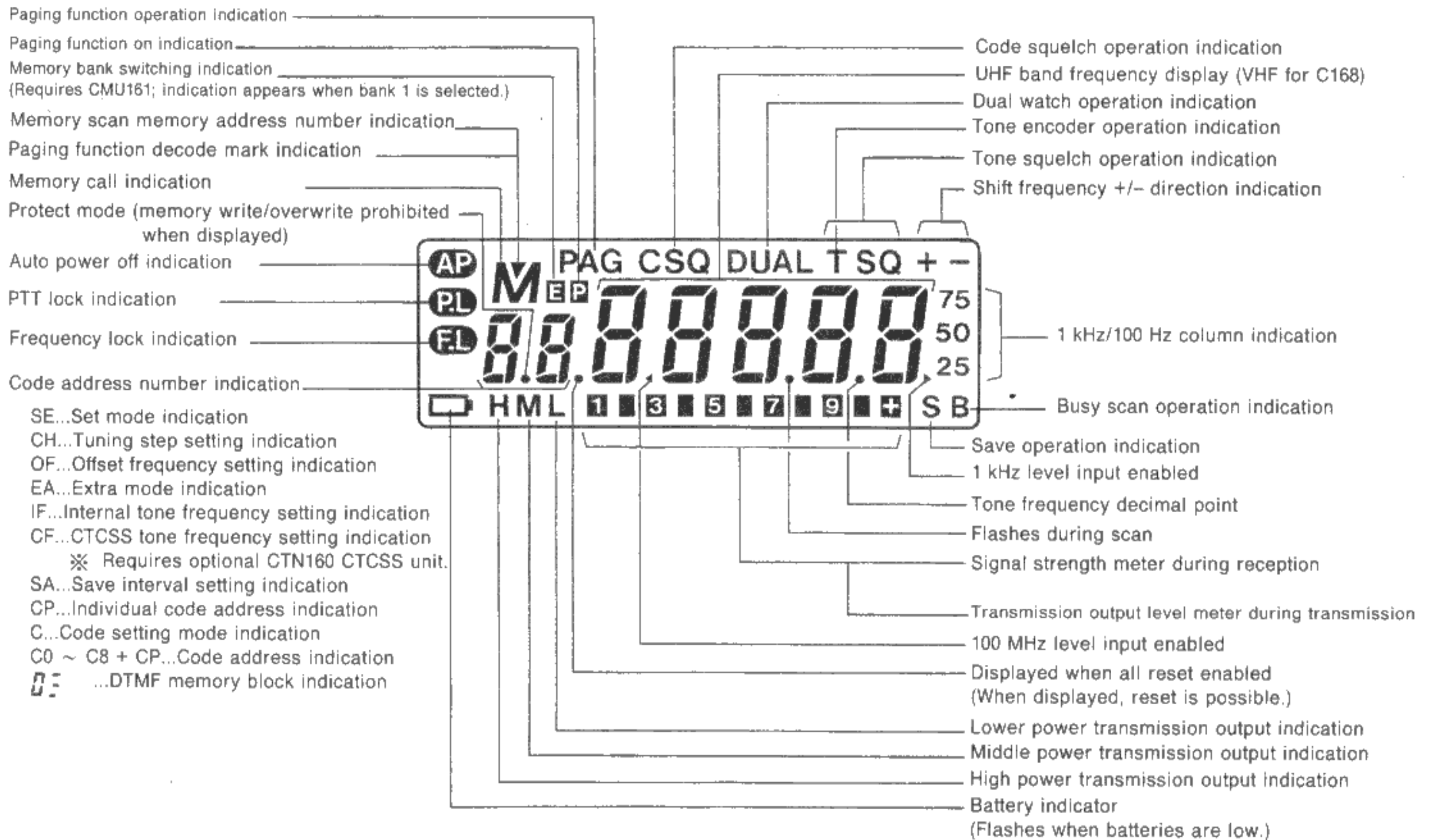

■ On this and the pages which follow, the functions of each key are described in the following order.

1) Key pressed directly

Function printed in ivory



2) Key pressed with FUNC key held down

Function printed in light blue



3) Key pressed in set mode

0 SET/SB Other key



4) Key pressed in set mode with FUNC key held down (except for 0 SET/SB)

0 SET/SB Other key except for 0 SET/SB

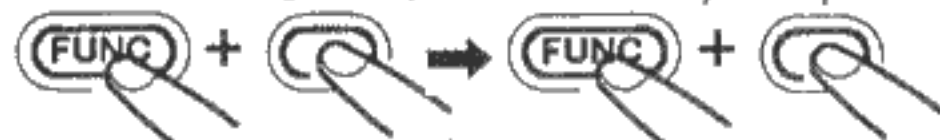

Set mode

5) Key pressed in extra mode

Extra mode

0 SET/SB Other key

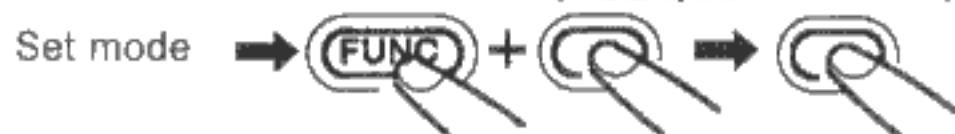

6) Numeric, A, B, C, D, \* or # key pressed with PTT switch held down

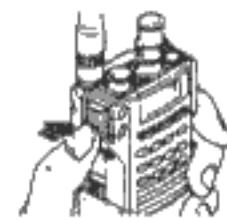

Numeric, A, B, C, D, \* or # key



1 PO

- 1) Inputs the numeral 1.
- 2) Switches transmission output.
- 3) Sets length of paging beep. (one or five times.)
- 4) All reset. (restores factory settings.)
- 5) High speed scan on/off.
- 6) Transmits DTMF signal 1.



---

## 1 PO

- 1) Inputs the numeral 1.
- 2) Switches transmission output.
- 3) Sets length of paging beep.  
(one or five times.)
- 4) All reset.  
(restores factory settings.)
- 5) High speed scan on/off.
- 6) Transmits DTMF signal 1.

## 2 DUAL

- 1) Inputs the numeral 2.
- 2) Toggles dual watch on/off.
- 3) Enables 1 kHz column input using numeric keys.
- 4) No function.
- 5) Raises dual watch speed.
- 6) Transmits DTMF signal 2.

## 3 SFT

- 1) Inputs the numeral 3.
- 2) Toggles shift mode on/off.  
(This function is used to change the memory frequency from the memory mode.)
- 3) Delays the transmission of paging signals when the paging and repeater functions are used together.
- 4) Enables all reset.,  
(Sets whether all reset should be allowed or not.)
- 5) Changes the LAMP key to the REV key during repeater operation.
- 6) Transmits DTMF signal 3.

#### 4 STEP

- 1) Inputs the numeral 4.
- 2) Sets the tuning step size.  
(The tuning step size can be set to 5, 10, 12.5, 20, 25, 50, 75 or 100 kHz; the factory setting is 10 kHz.)
- 3) Attenuates the pop noise which can be heard when squelch is opened. (Current consumption increases slightly.)
- 4) Switches to the protect mode.
- 5) Selects the save interval.
- 6) Transmits DTMF signal 4.

#### 5 SAVE

- 1) Inputs the numeral 5.
- 2) Toggles save on/off.
- 3) Toggles auto power off function on/off.
- 4) Squelches audio during paging even if code matches.
- 5) Reduces the DTMF transmission speed.
- 6) Transmits DTMF signal 5.

#### 6 F.L

- 1) Inputs the numeral 6.
- 2) Toggles the frequency lock function on/off.
- 3) Enables the rotary channel selector even when the frequency lock function is on.
- 4) Toggles the tuning step size when the rotary channel selector is turned with the FUNC key held down between 100 kHz and 1 MHz.
- 5) No function.
- 6) Transmits DTMF signal 6.

#### 7 T SQ/DM

- 1) Inputs the numeral 7.
- 2) Toggles tone squelch function on/off.
- 3) Switches to tone frequency setting mode.
- 4) Switches to the clone mode.
- 5) No function.
- 6) Transmits DTMF signal 7.
  - In the code setting mode, hold down the FUNC key and press the 7 T SQ/DM key to set the decode mark.

## 8 RPT

- 1) Inputs the numeral 8.
- 2) Toggles the repeater mode on/off.
- 3) Switches to the repeater shift frequency setting mode.
- 4) No function.
- 5) Enables frequency input in the 100 MHz column.
- 6) Transmits DTMF signal 8.

## 9 REV/HSC

- Press during scan operation to activate hold scan.
- 1) Inputs the numeral 9.
  - 2) Inverts the transmit and receive frequencies in repeater mode.
  - 3) Sets internal tone encoder frequency.
  - 4) Switches active bank of the optional CMU161 memory unit (if installed).
  - 5) No function.
  - 6) Transmits DTMF signal 9.

## 0 SET/SB

- Press during scan operation to toggle between pause scan and busy scan.
- 1) Inputs the numeral 0.
  - 2) Switches to set mode.
  - 3) Turns off beep.
  - 4) Switches to extra mode.
  - 5) No function.
  - 6) Transmits DTMF signal 0.

## A LAMP

- 1) Illuminates display lamp.
- 2) Turns display lamp on continuously.
- 3) No function.
- 4) No function.
- 5) No function.
- 6) Transmits DTMF signal A.

## B V/M ENT

- 1) Switches to memory call mode.
- 2) Switches to memory record mode.
- 3) No function.
- 4) Deletes memory contents.
- 5) No function.
- 6) Transmits DTMF signal B.

## C ▼ PAG

- 1) Decreases the frequency setting.  
In the memory call mode, it decrements the memory address number.  
In the code setting mode, it decrements the code address number.  
During scan operation, it causes scan to pause or to proceed in the downward direction.
- 2) Paging/code squelch on/off
- 3) No function.
- 4) No function.
- 5) No function.
- 6) Transmits DTMF signal C.

## D ▲ CODE

- 1) Increases the frequency setting.  
In the memory call mode, it increments the memory address number. In the code setting mode, it increments the code address number.  
During scan operation, it causes scan to pause or to proceed in the upward direction.
- 2) Switches to the code setting mode used by the paging function.
- 3) No function.
- 4) No function.
- 5) No function.
- 6) Transmits DTMF signal D.

## # CL PS

- 1) Activates the clear function.
- 2) Toggles VFO scan on/off.  
(1 MHz scan in VFO mode, full band scan in call mode.)
- 3) No function.
- 4) No function.
- 5) No function.
- 6) Transmits DTMF signal #.

## \* MS MS.M

- 1) Toggles memory scan on/off.
- 2) Sets the memory scan - memory.  
A ▼ is displayed above the M of the memory address number to be entered in memory for memory scan.
- 3) No function.
- 4) No function.
- 5) No function.
- 6) Transmits DTMF signal \*.

## SQL OFF/DTMF.M

- 1) Turns squelch off.
- 2) DTMF memory mode.
- 3) No function.
- 4) No function.
- 5) No function.
- 6) DTMF memory transmit mode.

## CALL/P.L

- 1) Calls up the call frequency.
- 2) Toggles PTT switch lock on/off.
- 3) No function.
- 4) No function.
- 5) No function.
- 6) (Burst signal key)  
Repeater access signal key

## Beep indications

When you press the control buttons of the unit, beeps inform you of the status of the operation being performed. The pitch and duration of the beeps differs as described below.



(Short high pitched beep)

Operation button pressed registered correctly.



(Long high pitched beep)

Operation successfully completed.  
(Example: Frequency successfully entered in memory.)



(Long medium pitched beep)

Operation button pressed not registered correctly or invalid button pressed.



(Repeated high pitched beeps)

Indicates auto power off operation or a transmission received in the paging mode.



(Repeated trilled beeps)

Transmission sent in the paging mode.



(Short low pitched beep)

Function canceled or initial settings restored.

# Repeater Operation

## ■ About repeater operation

- This term refers to radio communication via a "repeater station" (a relay station).
- Since a repeater station is required, the repeater function is generally only used to communicate with locations too far away to communicate with directly.
- Transmitting and receiving via the repeater station takes place on different frequencies.  
(The sending frequency is 600 Hz (VHF), 1.6 MHz (UHF) lower than the receiving frequency.)
- This unit automatically sets the sending frequency 600 Hz (VHF), 1.6 MHz (UHF) lower than the receiving frequency when the repeater function is turned on.
- Pressing the CALL button during transmission activates the repeater station.

## ■ Conventional operation

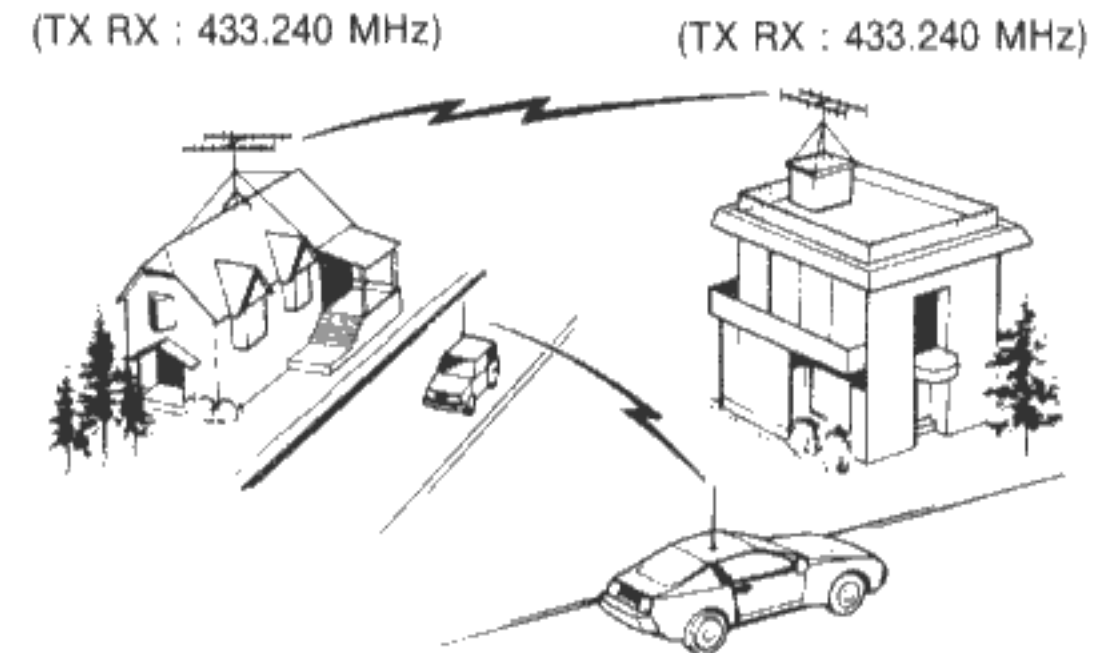

## ■ Repeater operation

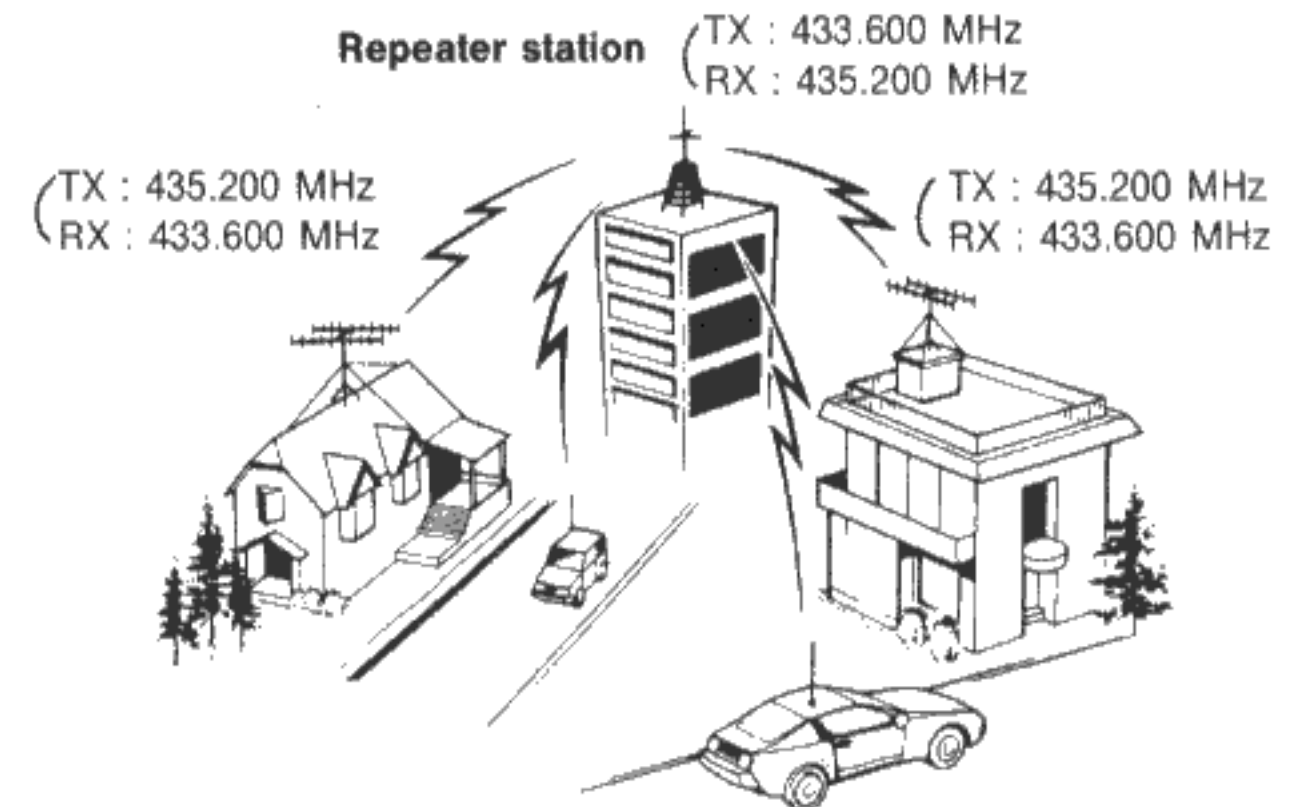

## Repeater operation

### PROCEDURE

- 1) Set the frequency to match that of the repeater station.  
(Example: 439.52 MHz)
- 2) Hold down the FUNC key and press the 8 RPT key.  
When you press the PTT switch the signal is transmitted at a frequency 5 MHz lower than the frequency shown on the display (-5 MHz offset).  
(To transmit with a +5 MHz offset, hold down the FUNC key and press the 8 RPT key again.)
- 3) While transmitting, press the CALL/P.L key to access the repeater station.  
(The 1,750 Hz burst signal is transmitted only while the CALL/P.L key is depressed.)

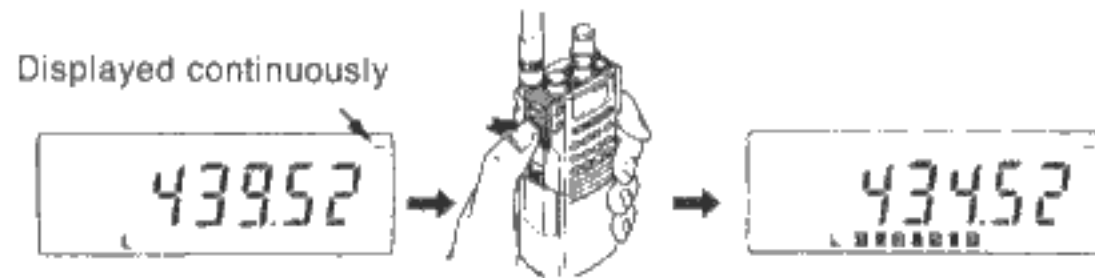

## Canceling the repeater function

### PROCEDURE

- 1) Hold down the FUNC key and press the 8 RPT key.  
A [ - ] appears on the display, indicating -5 MHz offset status.
- 2) Hold down the FUNC key and press the 8 RPT key once again. A [ + ] appears on the display, indicating +5 MHz offset status.
- 3) Hold down the FUNC key and press the 8 RPT key a third time. The [ + ] indication disappears from the display and the repeater mode is canceled.

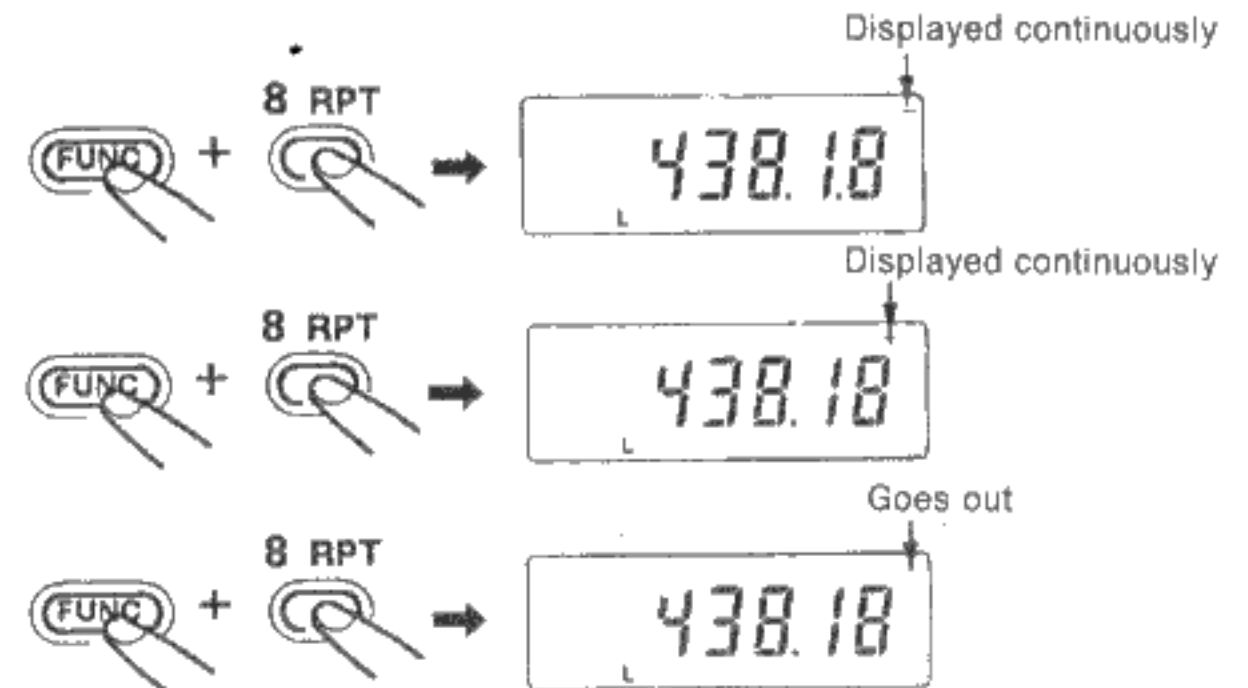

## ■ Reversing the repeater send/receive frequencies

- This function allows you to communicate directly with another station (without using the repeater station). It is called reverse (REV) operation.

### PROCEDURE

- 1) Hold down the FUNC key and press the 9 REV/HSC key. The [ - ] or [ + ] indication on the display flashes on and off to indicate that the sending and receiving frequencies have been reversed.
- 2) To cancel this function, hold down the FUNC key and press the 9 REV/HSC key again.

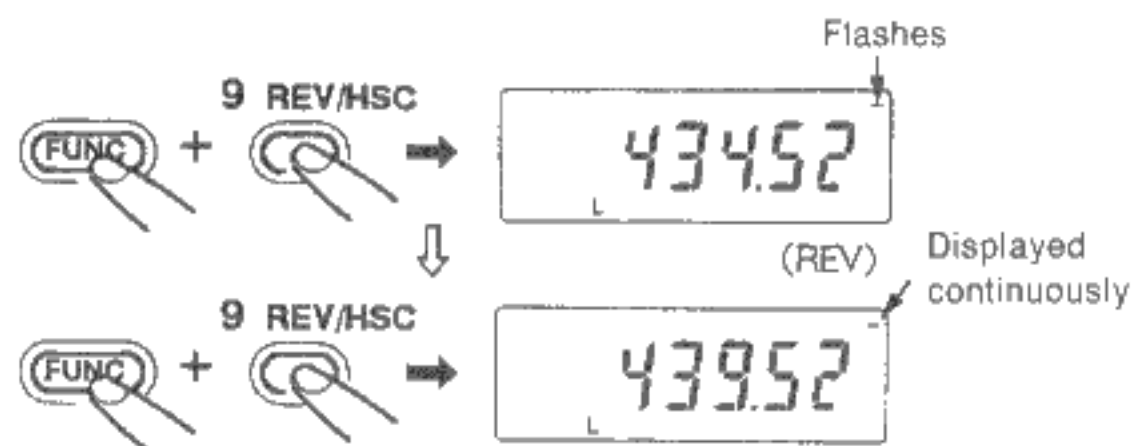

### ADVICE

- (1) If, after step 1) above is performed, you succeed in communicating with the other station, you may be able to continue to communicate without using the repeater function at all. If direct contact has been established, try communicating without using the repeater function (simplex operation).
- (2) Using simplex operation means that more other people can use the repeater station. It is therefore desirable to use simplex operation whenever possible (as a courtesy to other users of the repeater station).

### NOTE

- (1) If the frequency setting is such that the offset frequency (whether for sending or receiving) would be pushed outside of the 400 (100) MHz range, the display will not change and nothing will be transmitted. If performing step 1) above would result in an off band frequency, a boo (long medium pitched beep) sounds and the new setting is not made.



## ■ Setting the CTCSS tone frequency

- This function is available if the optional CTN160 CTCSS unit (tone squelch) has been installed. There are 38 tone squelch frequencies to choose from.

### PROCEDURE

- 1) Switch to the set mode.
- 2) Press the 7 T.SQ/DM key.

The current CTCSS tone frequency setting appears on the display.

The CF indication also appears, showing that the unit is in the CTCSS tone frequency setting mode. (CF stands for CTCSS FREQUENCY.)



- 3) Select the tone frequency of your choice using the ▼/▲ keys or the rotary channel selector. During frequency setting, a puff (short low pitched beep) sounds at 88.5 Hz.
- 4) After setting the desired frequency, press the # CL PS key.

## ■ Changing the offset frequency

- The factory setting for the offset frequency is 5 MHz. Follow the procedure below to set a new offset frequency.

### PROCEDURE

- 1) Switch to the set mode.
- 2) Press the 8 RPT key.

The current offset frequency setting appears on the display. The [OF] indication also appears, showing that the unit is in the offset frequency setting mode. (OF stands for OFFSET FREQUENCY.)



- 3) Set the new offset frequency using the 0 ~ 9 keys, the ▲/▼ keys, or the rotary channel selector.
- 4) After setting the desired frequency, press the # CL PS key.

## ■ Assigning the LAMP key to the REV function

### PROCEDURE

- 1) Switch to the extra mode.
- 2) Press the 3 SFT key.  
A pip (short high pitched beep) sounds, indicating that the LAMP key has been assigned to the REV function.

- 3) To assign the LAMP key back to the LAMP function, switch back to the extra mode and press the 3 SFT key again.  
A puff (short low pitched beep) sounds, indicating that the LAMP key has been assigned back to the LAMP function.

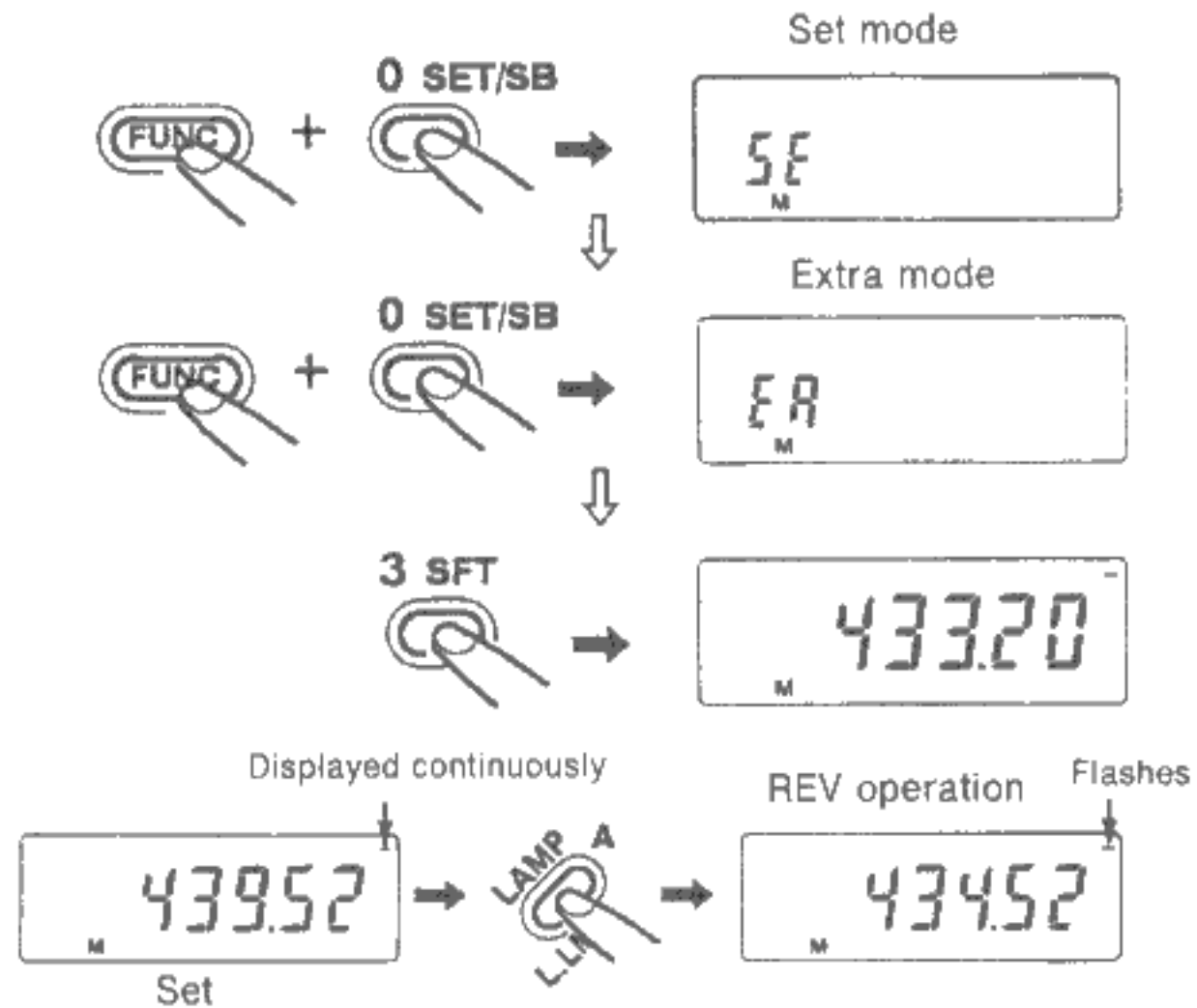

# Paging Operation

- This function can be used to page individual stations (personal paging) or a specific group of stations (group paging).

## NOTE

(1) *The paging function requires that the sending and receiving ends use matching personal or group paging codes. The same group code must be used by every member of the group.*

## Preparations for paging

- You must perform the following steps before you can use the paging function.

## PROCEDURE

- 1) Decide on your own personal code and record it in memory at code address number 0.
- 2) Decide on the other codes you will use (personal codes of other stations or group codes) and record them in memory at code address numbers 1 ~ 8.
- 3) Indicate the code address numbers between 1 ~ 8 which you wish to use as group code address numbers during reception with the ▼ (decode mark) symbol. (See the section describing the method for designating code address numbers as group codes for receiving.)

## Code address numbers and their functions

Memory address number	Paging function (the code setting and your personal code setting are broadcast.)
P	<p>The personal code of the station called is automatically recorded at this address.</p> <p>The personal code of the other station is automatically recorded in memory and appears on the display.</p> <p>If you press the PTT button at this point, the code being displayed is transmitted.</p>
0	<p>This is the memory address for your personal code. When you are called with your personal code, the personal code of the other station (memory address 0) appears on the display.</p> <p>If you press the PTT button at this point, the code being displayed is transmitted.</p>
1 2 3 4 5 6 7 8	<p>These memory addresses are for the personal codes of other stations and group codes.</p> <p>Group codes designated with the ▼ mark can be used for receiving.</p> <p>The ▼ mark is the decode mark.</p> <p>The ▼ mark can be assigned to more than one memory address.</p>

## 1) Setting your personal code

- Codes consist of three numerals.

Perform the steps below to set your personal code.

**Example** Setting the personal code to 1,1,1.

### PROCEDURE

- Hold down the FUNC key and press the D ▲ CODE key. The code address number which was used last is displayed. (This is set to 0 when the unit is shipped from the factory.)

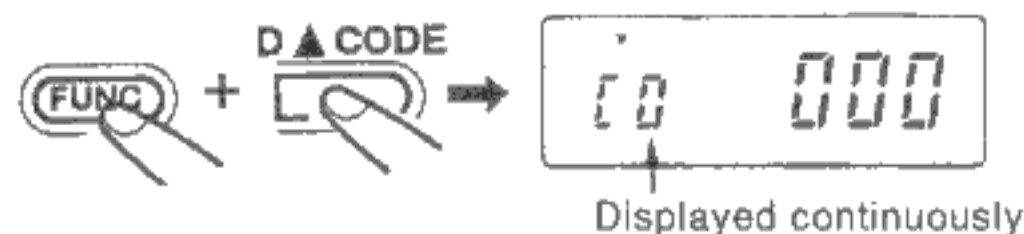

- Select code address number 0 using the ▲ / ▼ keys or the rotary channel selector. A puff (short low pitched beep) sounds when code address number 0 is selected.
- Input your personal code. Use the numeric keys to input 1,1,1. Three 1s appear one after another on the display. When the last digit is entered, a peep (long high pitched beep) sounds to indicate that the code has been set.

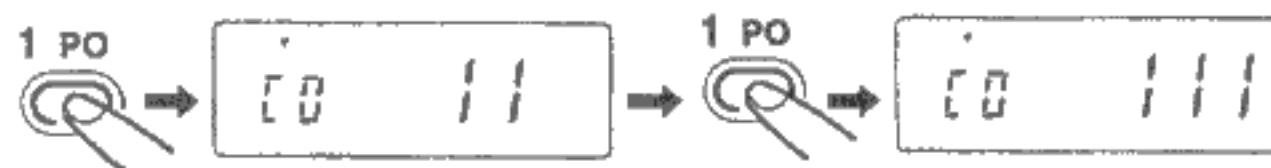

### ADVICE

- The personal code transmitted to you from the other station is stored at memory code address number P. Code address number P can be used in the same way as address numbers 1 ~ 8, but it is automatically overwritten with the personal code of the other station when a paging transmission is received.
- The station code of the station you are communicating with is displayed as code address number P.

### Setting example

Memory address number	Decode mark	Station A	Station B	Station C
Your personal code 0	▼	111	222	333
Code 1	—	222	111	111
Code 2	▼	050	050	050
Code 3	—	333	333	222

## 2) Setting personal codes of other stations

### PROCEDURE

- 1) Hold down the FUNC key and press the D ▲ CODE key.
- 2) Select the code address number of your choice using the ▲ /▼ keys or the rotary channel selector.
- 3) Input the personal code using the numeric keys.  
To record more than one code in memory, repeat steps 2) and 3) above as many times as necessary.

### ADVICE

- (1) Input the group codes you wish to use for receiving as well as those you will use for transmitting.

## 3) Designating group codes for receiving

- After the codes have been recorded in memory, designate which group codes you wish to use for receiving.

### PROCEDURE

- 1) Call up the code address of the code (1 ~ 8) you wish to designate as a group code for receiving.
- 2) Hold down the FUNC key and press the 7 T.SQ/DM key. A ▼ appears in the upper left of the display indicating that the currently displayed code address has been designated as a group code for receiving. The ▼ indication is referred to as the decode mark.

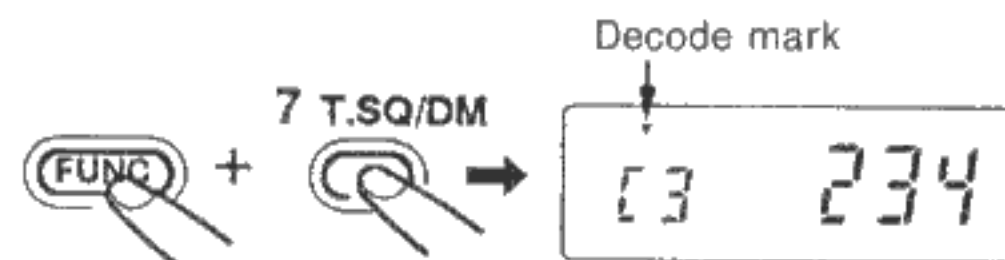

### ADVICE

- (1) More than one code address can be designated with the decode mark. To designate more than one group code, repeat steps 1) and 2) above as many times as necessary.

## 4) Canceling group codes

- The group code status of a code address is canceled by removing the decode mark.

### PROCEDURE

- 1) Hold down the FUNC key and press the D ▲ CODE key.
- 2) Call up the code address of the group code you wish to cancel.
- 3) Hold down the FUNC key and press the 7 T.SQ/DM key. A puff (short low pitched beep) sounds and the ▼ indication disappears. The group code status of the code address is canceled.

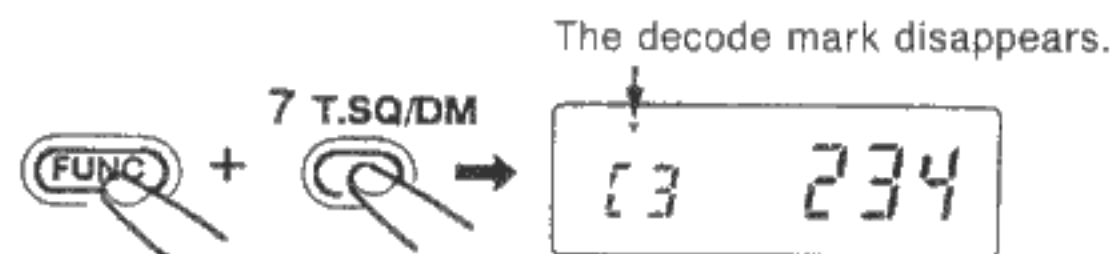

### NOTE

- (1) The ▼ mark cannot be canceled for code address number 0.

## ■ Paging operation

- Paging operation is described separately below for the transmitting (you) and receiving (other) sides.
- Both the transmitting and receiving side must use the same frequency.

### ■ Transmitting side (you)

#### PROCEDURE

- 1) Select the code address corresponding to the personal code of the station you wish to page. If the desired code is not in the unit's memory, enter it.
- 2) Press the # CL PS key.
- 3) Hold down the FUNC key and press the C ▼ PAG key. PAG P appears on the display.
- 4) Press the PTT switch.  
The code (DTMF signal) is transmitted and pilala-pilala-pilala (repeated trilled beeps) is heard. The code transmitted is  $\times \times \times * \triangle \triangle \triangle$ .
- 5) When a signal is received from the other station, the paging mode is canceled and normal communication is possible.

#### Code which appears on display

The CP indication means that you have been paged by your individual code. (The code of the station calling is 111.)



The unit's microprocessor automatically determines whether the code is a private or group code.

#### The code recorded at code address 0

An indication other than CP means that you have been paged using a group code. (The station calling is someone in group 050.)

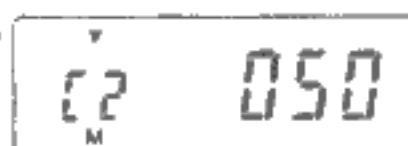

### ■ Receiving (other) side

#### PROCEDURE

- 1) Hold down the FUNC key and press the C ▼ PAG key. PAG P appears on the display.
- 2) If the received code and the code recorded at code address 0 match:
  - a. Five pips (high pitched beeps) sound.
  - b. PAG flashes on and off on the display.
  - c. The personal code of the calling station appears on the display and is recorded in memory at code address P.
- 3) If the received code and one of the codes with a ▼ designation match:
  - a. Five pips (high pitched beeps) sound.
  - b. PAG flashes on and off on the display.
  - c. The matching group code appears on the display.
- 4) When the PTT switch is pressed, the displayed code and the personal code (of the calling side) are transmitted. This means that you can send your code to the other (receiving) station.
- 5) The paging mode is canceled and normal communication is possible.

#### NOTE

$\times \times \times$  : Code selected from the available code addresses

$\triangle \triangle \triangle$  : Your personal code

**Operation example** Assign codes to code address numbers.

**ADVICE**

- During paging operation, the code shown on the display is transmitted.

**Station A: Code address assignments**

- 0 : 111 – personal code for station A
- 1 : 222 – personal code for station B
- 2 : 050 – group code

(Add the decode mark to each address number.)

**Station B: Code address assignments**

- 0 : 222 – personal code for station B
- 1 : 111 – personal code for station A
- 2 : 050 – group code

(Add the decode mark to each address number.)

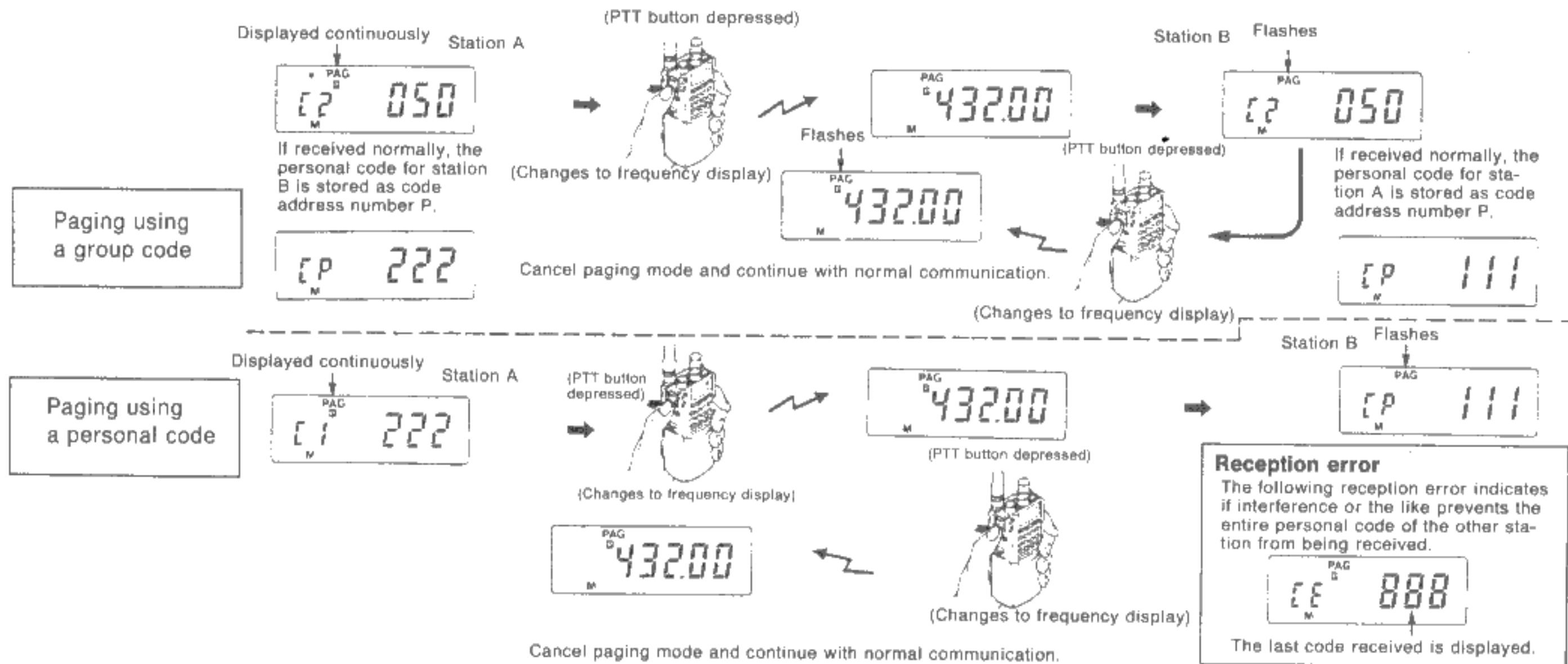

#### ADVICE

- (1) If the codes match, the unit displays the contents of code address P, indicating that you have been paged using your personal code. If something other than code address P appears, you have been paged using a group code.
  - (2) The personal code of the calling station is recorded at code address P even if you are paged using a group code. By checking code address P you can determine which member of the group is calling.
- 3) Communicating after codes match
- If the codes match, switch the PAG function off and communicate normally.

#### PROCEDURE

- 1) Hold down the FUNC key and press the C ▼ PAG key twice.  
The display indication changes from PAG P to CSQ to nothing. This indicates that the PAG function is off.  
Continue with normal communication.

#### ADVICE

- (1) If the C ▼ PAG key is pressed with the FUNC key held down while the PAG indication is flashing, PAG disappears and the indication P remains.  
This means that the PAG function is temporarily suspended.
- (2) Normal communication is possible when the P indication is displayed, just as if step 1) at left had been performed. However, in this status the microprocessor still considers the paging function to be on. So if you turn the power off and then on, or change the frequency, PAG will reappear on the display.



# Code Squelch Operation

- As with the paging function, code squelch permits communication only after matching a 3-digit code. It operates similarly to the tone squelch function.

## PROCEDURE

- 1) Hold down the FUNC key and press the D ▲ CODE key.



- 2) Select the code you wish to use.
- 3) Press the # CL PS key.



- 4) Hold down the FUNC key and press the C ▼ PAG key twice. The CSQ indication appears on the display.



- 5) Begin code squelch operation using the code you have selected.

## NOTES

- (1) Communication is not possible if the code selected does not match that of the other station. Decide on the code to be used beforehand.
- (2) Any code address number can be used for this function.

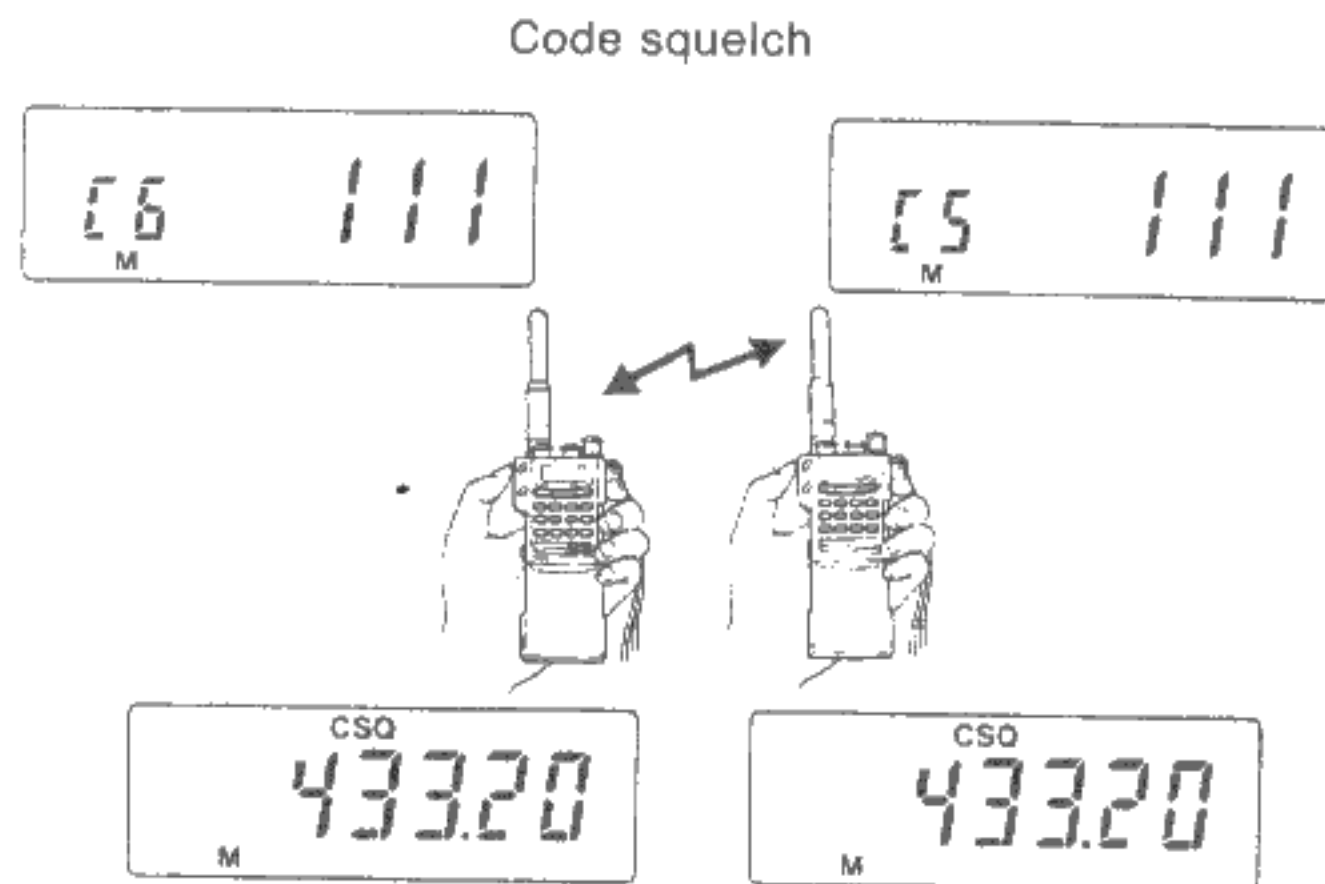

# Tone Squelch Operation

- The tone squelch function requires that the optional CTN160 CTCSS unit be installed.

## PROCEDURE

- 1) Hold down the FUNC key and press the 7 T.SQ/DM key once.

A "T" appears on the display to indicate that the tone encode mode is active.

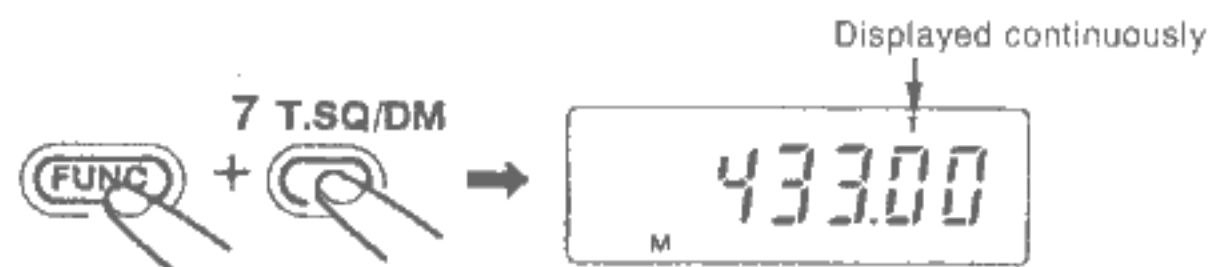

- 2) Hold down the FUNC key and press the 7 T.SQ/DM key once again.

TSQ appears on the display to indicate that tone squelch operation is possible.

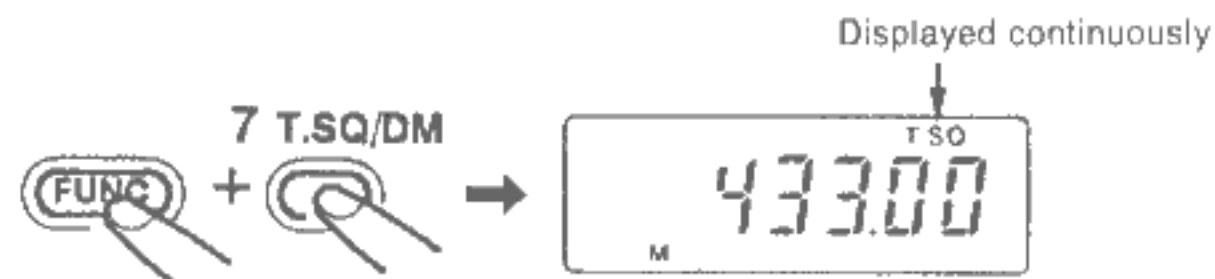

- 3) To cancel the tone squelch mode, hold down the FUNC key and press the 7 T.SQ/DM key. The TSQ indication disappears on the display, and tone squelch is deactivated.

## NOTES

- (1) If the CTN160 is not installed, the TSQ indication appears after the 7 T.SQ/DM key is pressed once to indicate that the required CTCSS unit has not been connected.
- (2) It is necessary that the tone frequency match that of the other station.

Downloaded by   
  
Amateur Radio Directory

# Memory Operation

## ■ Memory function

The C168 and C468 use a memory unit to implement the memory function.

Memory operation is therefore possible only if the memory unit has been installed.

Installation of the memory unit is highly recommended. (The C168 and C468 will operate without it, but only in the VFO mode.)

The C168 and C468 are shipped from the factory with the CMU160 40-channel memory unit already installed.

The optional CMU161 increases the number of memory channels to 100 channels for each of two banks, or a total of 200 channels.

- The memory function allows you to store frequently used frequencies for use when needed.
- Up to 40 separate frequencies can be stored in memory.
- The locations where frequencies are stored are called "memory address numbers."
- The memory address numbers range from M00 through M39.
- With the optional CMU161, the available memory address numbers are increased to [M00 ~ M99] x 2 banks, for a total of 200 memory frequencies.

### NOTE

- Refer to the section on bank switching when using the CMU161 (page 58) for more information.

## ■ Storing frequencies in memory

**Example** Entering 433.10 MHz in memory as M26

### PROCEDURE

- 1) In the VFO mode, select the frequency 433.10 MHz so that it appears on the display.

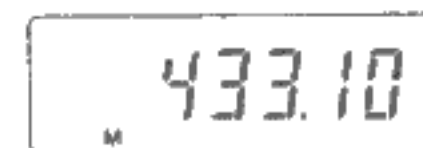

- 2) Hold down the FUNC key and press the B V/M ENT key. The M indication appears on the display.

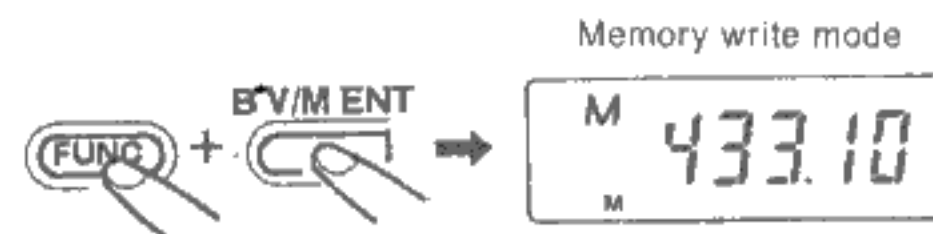

- 3) Press the 2 DUAL key. A 2 appears on the display below the M.
- 4) Press the 6 F.L key. A peep (long high pitched beep) sounds to indicate that the frequency has been stored in memory. This status is referred to as the memory mode.



### NOTE

- To store a frequency as M01, you would press the 0 key followed by the 1 key.

## ■ Storing tone frequencies, etc. in memory

- In addition to transmitting and receiving frequencies, the following settings can also be stored in memory by the C168/C468.

- CTCSS tone frequency : (Page 33)
- Tone encode mode : (Page 33)
- Tone squelch mode : (Page 33)
- Paging mode : (Page 26)
- Code squelch mode : (Page 32)
- Paging/code squelch transmission code address : (Pages 26 , 32)
- Repeater mode : (Page 22)
- Offset frequency : (Page 25)

The above settings can be stored in the unit's memory by performing the appropriate operations while in the memory call mode. See the page numbers printed in parentheses for detailed descriptions of the necessary steps.

## ■ Calling up memory frequencies

- Memory (number) frequencies can be called up using any of the following three methods.

- (1) Inputting the memory address directly using the numeric keys
- (2) Calling up a frequency using the rotary channel selector
- (3) Calling up a frequency using the ▲/▼ keys.

- (1) Inputting the memory address directly using the numeric keys

**Example** Calling up M07

### PROCEDURE

- 1) In the VFO mode, press the B V/M ENT key.  
The memory mode is activated and the memory address which was used last appears on the display.  
(When the memory mode is activated for the first time, M00 is displayed.)

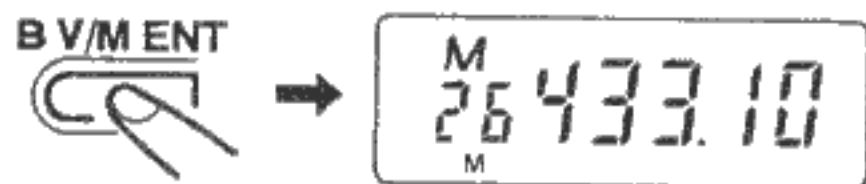

- 2) Press the 0 SET/SB key.  
M0 is displayed.



- 3) Press the 7 T.SQ/DM key.

A peep (long high pitched beep) sounds to indicate that memory address number 7 has been called up.

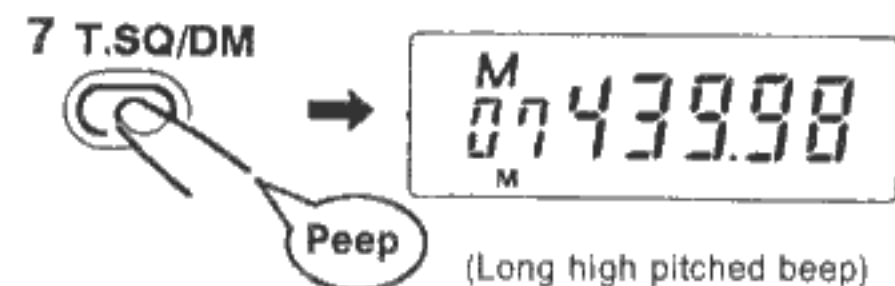

**Example** To call up M26, you would press the 2 DUAL key followed by the 6 F.L key.

### ADVICE

- (1) The M indication may start to flash on and off when you call up a memory address number.  
This indicates that no frequency is currently assigned to the memory address number you have selected.  
(In the following pages, memory address numbers to which no frequencies have been assigned are referred to as "free memory address numbers.")
- (2) If a free memory address number is called up, the VFO frequency is displayed.

## (2) Calling up a frequency using the rotary channel selector

- You can select a memory address number by turning the rotary channel selector after activating the memory mode.

### ADVICE

- You can change the 10's column of the memory address number display by turning the rotary channel selector with the FUNC key held down.

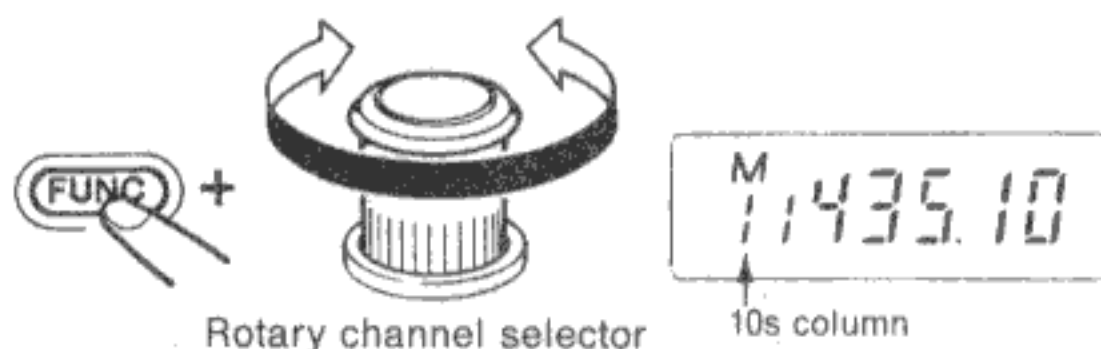

## (3) Calling up a frequency using the ▲/▼ keys

- You can select a memory address number using the ▲/▼ keys after activating the memory mode.

### ADVICE

- If the ▲/▼ keys are held down for 0.5 seconds or more, the memory address setting changes slowly and continuously in the direction indicated until the key is released.

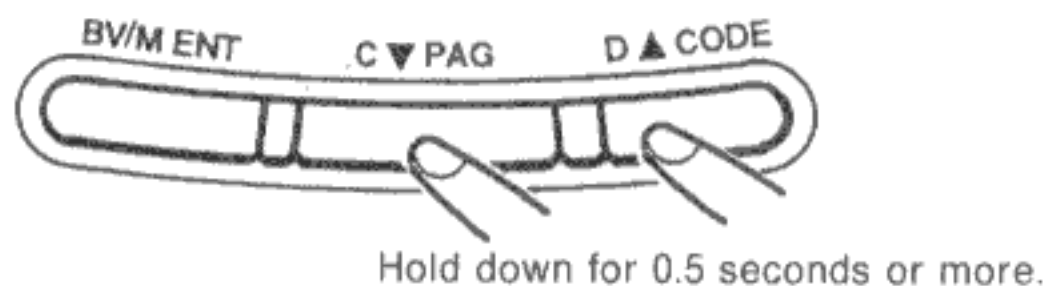

## Changing a memory frequency

- Select the new frequency so that it appears on the display and punch in the memory address number you wish to change.

**Example** Changing M07 from 433.50 MHz to 433.12 MHz

### PROCEDURE

- In the VFO mode, select the frequency 433.12 MHz so that it appears on the display.

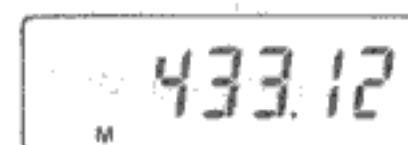

- Hold down the FUNC key and press the BV/M ENT key.

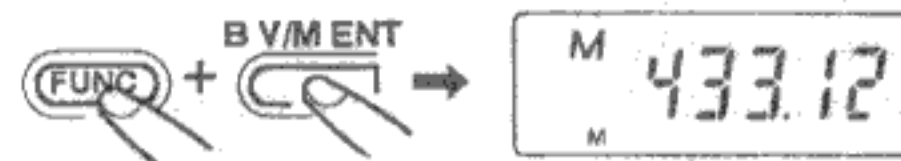

- Press the 0 SET/SB key.

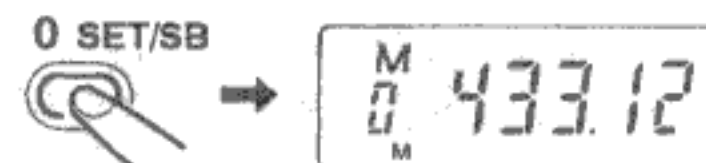

- Press the 7 T.SQ/DM key. A peep (long high pitched beep) sounds to indicate that the new frequency has been stored in memory in place of the old one.

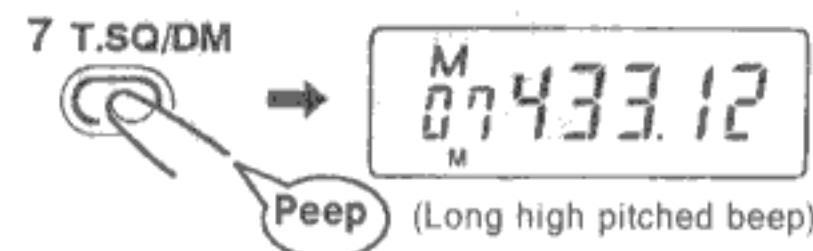

## ■ Deleting a memory frequency

**Example** Deleting the frequency 433.12 MHz from M07

### PROCEDURE

- 1) In the memory mode, call up the memory address whose contents you wish to delete so that it appears on the display.

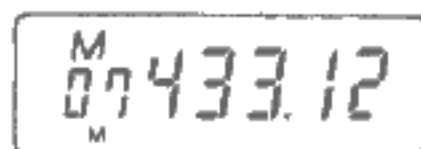

- 2) Hold down the FUNC key and press the 0 SET/SB key to activate the set mode.



- 3) Hold down the FUNC key and press the B V/M ENT key. A peep (long high pitched beep) sounds to indicate that the memory frequency has been deleted. (M07 becomes a free memory address number and the M indication begins to flash on and off.)

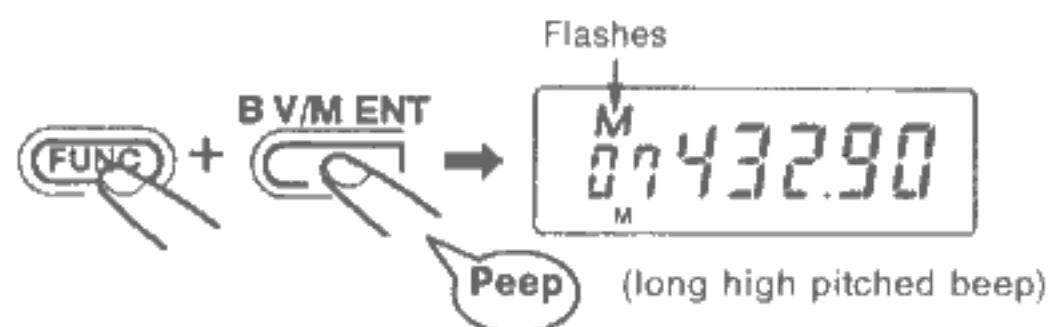

### ADVICE

- After a memory frequency is deleted, the memory address number to which it was assigned returns to its factory status.

## ■ Changing frequencies in the memory mode (memory shift mode)

- The operations of the VFO mode are also accessible from the memory call mode. The status in which such operations are possible is referred to as the memory shift mode.

### PROCEDURE

- 1) Switch to the memory mode.
- 2) Hold down the FUNC key and press the 3 SFT key. The memory address number on the display flashes on and off.
- 3) Select the desired frequency. As in the VFO mode, you can select the frequency using the and ▲/▼ keys, the rotary channel selector or the numeric keys.
- 4) Hold down the FUNC key and press the B V/M ENT key. (The current memory frequency is overwritten and the memory address number stops flashing and is displayed continuously.)

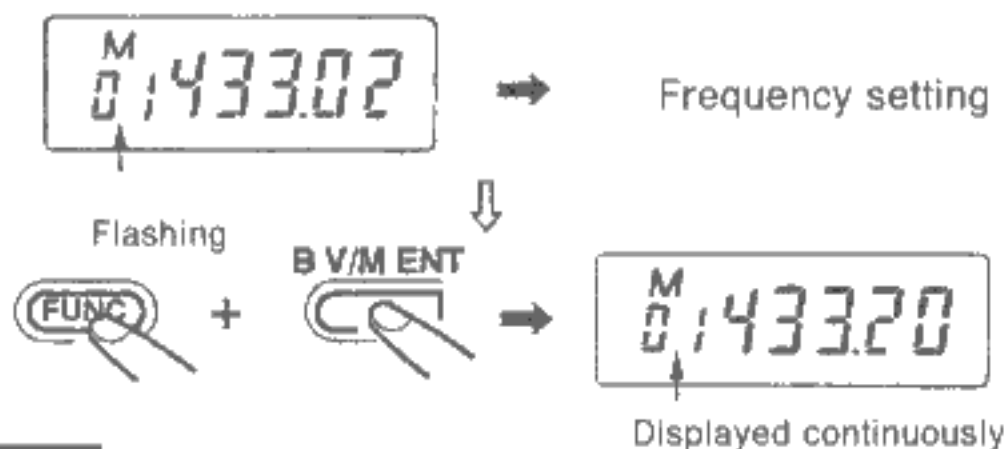

### ADVICE

- To cancel the memory shift mode, either hold down the FUNC key and press the 3 SFT key or press the # CL PS key directly. The previous memory frequency will reappear on the display.

# Scan Operation

## Scan types

- There are three scan types to choose from: pause scan, busy scan and hold scan.

Independent of the above three scan types, the microprocessor automatically determines the scan speed (intelligent scan function) based on factors such as the amount of frequency variation, whether T SQ is on or off, etc.

### (1) Pause scan

Scan pauses when a signal is received. Five seconds later, scan operation recommences even if a signal is still being received. (If the signal is lost in less than five seconds, scan recommences immediately.)

### (2) Busy scan

Scan is paused for as long as a signal is being received. Scan operation recommences two seconds after the signal is lost.

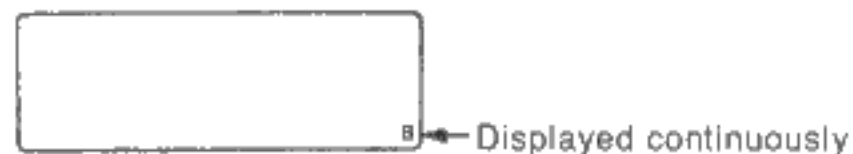

### (3) Hold scan

Scan is temporarily suspended when a signal is received. Pressing the ▲/▼ keys causes scan operation to recommence.



#### ADVICE

- (1) The scan type can be changed even while a scan is in progress. (See page 43 for details.)

## Scan functions

### (1) VFO scan

- 1) Scanning the 1 MHz range of your choice [1 MHz scan]
- 2) Scanning an entire band [Full band scan]
- 3) Scanning a range of frequencies specified by you [Program scan]

### (2) Memory scan

- 1) Scanning all memory addresses stored in memory [Memory scan]
- 2) Scanning a memory address block specified by you [Block memory scan]
- 3) Scanning memory addresses specified by you [Memory scan memory]

#### NOTES

- (1) If the save function is on, save memory scan operation will result.
- (2) If the save function is on and a scan type other than memory scan is initiated, the save function is suspended.

### (3) Tone frequency scan

- 1) Scans the tone frequencies.  
The optional CTN160 CTCSS unit is required.



## ■ Using the scan functions

### (1) Using VFO scan

#### (1) 1 MHz scan

In the VFO mode, hold down the FUNC key and press the # CLPS key.

The decimal point on the display flashes on and off to indicate scan operation.



#### (2) Full band scan

1) Press the CALL key. (The call mode is activated.)

2) Hold down the FUNC key and press the # CL PS key.

The decimal point on the display flashes on and off to indicate full band scan operation.



#### (3) Program scan

This function scans a range of frequencies specified by you. Before starting the scan, you must store the scan start and end frequencies in memory.

**Example** Scanning the range from 432.00 ~ 433.80

#### PROCEDURE

1) Store the scan start frequency in memory. (Any memory address number may be used.)

- 2) Store the scan end frequency in memory. (Any memory address number other than that of the start frequency may be used.)
- 3) Switch to the memory mode and call up the memory address number of the start frequency.

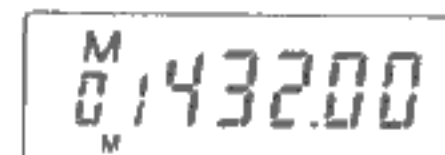

- 4) Hold down the FUNC key and press the # CL PS key. The memory address number on the display flashes on and off.



- 5) Press the numeric keys corresponding to the memory address number of the end frequency. After inputting the number (two digits), the memory address number indication disappears from the display and program scan operation commences immediately. (Decimal point flashes.)

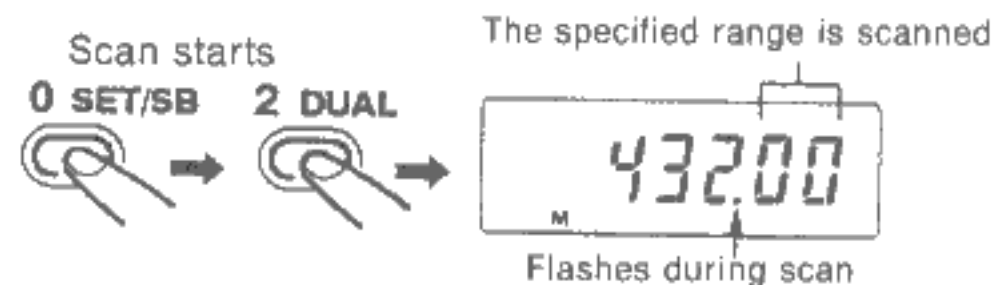

#### ADVICE

- If the start frequency is higher than the end frequency, the scan starts from the higher frequency and proceeds towards the lower.

## (2) Cancelling scan operation

Press the # CL PS key.

# CL PS



Scan is cancelled.

## (3) Other points regarding VFO scan

- 1) The display during 1 MHz scan, full band scan and program scan is identical.
- 2) Pressing the ▲/▼ keys during a scan pauses scan operation.  
To restart, press the ▲/▼ keys again.
- 3) The scan direction can be changed, depending on the key used to restart it.  
Pressing the ▲ key twice during scan operation switches to upward scan (lower to higher frequencies).  
Pressing the ▼ key twice during scan operation switches to downward scan (higher to lower frequencies).

## (4) Using memory scan

### (1) Memory scan

Press the ✖ MS MS.M key. (Memory scan is activated.)  
If all memory address numbers are free, a boo (long medium pitched beep) sounds and no scan is initiated.

### (2) Block memory scan

The memory address numbers from M00 to M39 are divided into four blocks, and the block of your choice is scanned.

The memory address number block assignments are as follows.

Block 0 : M00 ~ M09 are scanned.

Block 1 : M10 ~ M19 are scanned.

Block 2 : M20 ~ M29 are scanned.

Block 3 : M30 ~ M39 are scanned.

### PROCEDURE

- 1) Press the ✖ MS MS.M key to activate memory scan.
- 2) Press the numeric key corresponding to the number of the block (0 ~ 3) you wish to scan.  
Block memory scan begins.  
If all memory address numbers in the specified block are free, a boo (long medium pitched beep) sounds and no scan is initiated.
- 3) To return to memory scan, press the ✖ MS MS.M key.

### ADVICE

- If the optional CMU161 memory unit is installed, the available block numbers are 0 ~ 9.

## (5) Memory scan memory

- Only the memory address numbers specified are scanned.

### PROCEDURE

- Call up one of the memory address numbers you wish to scan.
- Hold down the FUNC key and press the \* MS MS.M key. A ▼ (mark) appears above the M indication.

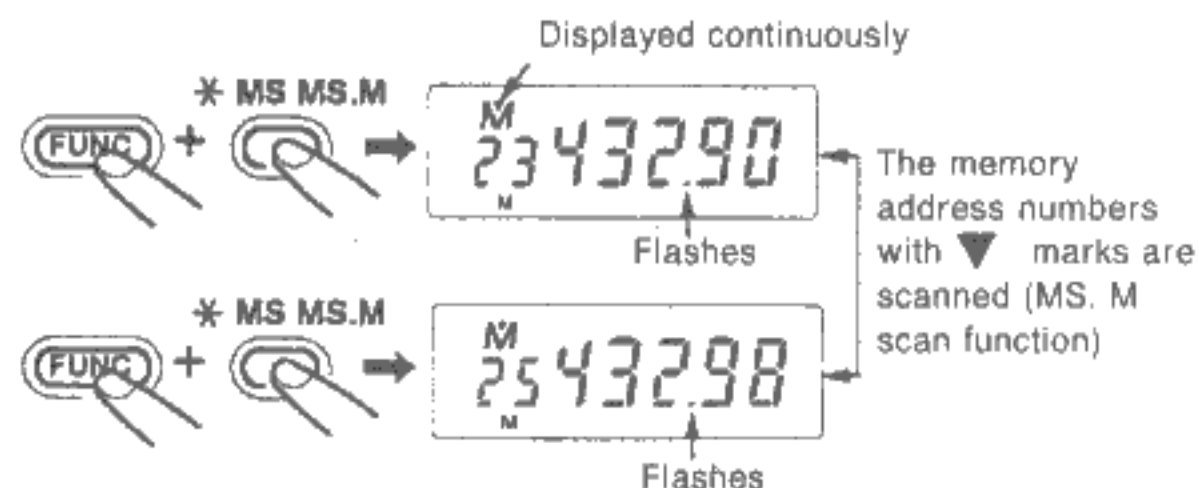

- In like manner, mark all the memory addresses you wish to scan with the ▼ indication.
- Press the \* MS MS.M key to activate memory scan.
- Hold down the FUNC key and press the \* MS MS.M key. Only the memory address numbers with ▼ marks are scanned.
- To return to normal memory scan, hold down the FUNC key and press the \* MS MS.M key.

### ADVICE

- In the VFO mode, holding down the FUNC key and pressing the \* MS MS.M key causes a ▼ to appear on the display. Pressing the \* MS MS.M key at this point initiates memory scan memory.

## (6) Canceling memory scan

- Press the # CL PS key. (The memory mode resumes.) Alternately, press the B V/M ENT key. (This switches to the VFO mode.)

## (7) Tone frequency scan

- The optional CTN160 CTCSS unit is required. If the CTN160 is not installed, a boo (long medium pitched beep) sounds and tone frequency scan does not take place. Tone frequency scan scans the tone frequency of the current reception frequency.

### PROCEDURE

- Hold down the FUNC key and press the 7 T.SQ/DM key twice. The TSQ indication disappears on the display.

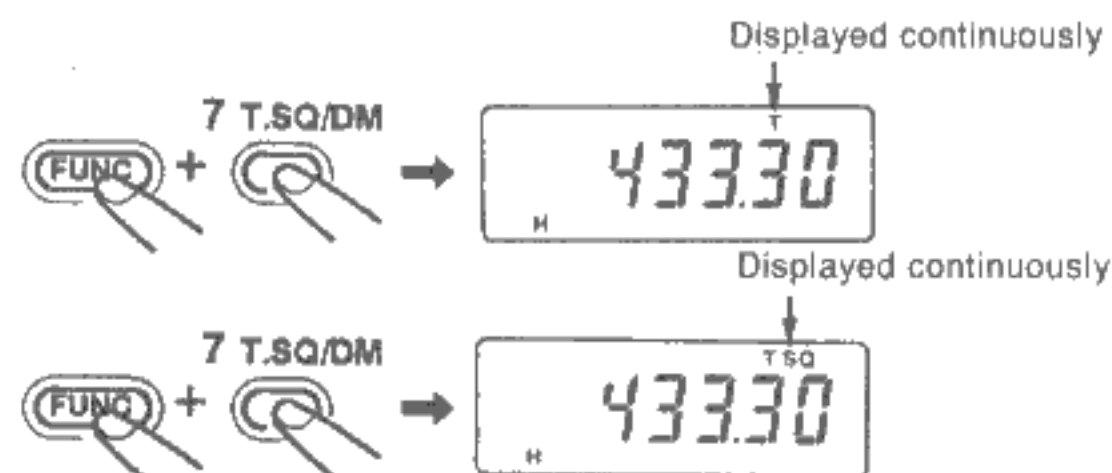

- Hold down the FUNC key and press the 0 SET S/B key.



- 3) Press the 7 T.SQ/DM key.  
The tone frequency appears on the display.



- 4) Hold down the FUNC key and press the # CL PS key.  
Tone frequency scan commences.  
5) To stop tone frequency scan, press the # CL PS key.

## Switching between pause scan, busy scan and hold scan

### (1) Busy scan

#### PROCEDURE

- 1) During scan operation, hold down the FUNC key and press the 0 SET S/B key.  
A B indication appears in the lower right portion of the display and busy scan is activated.

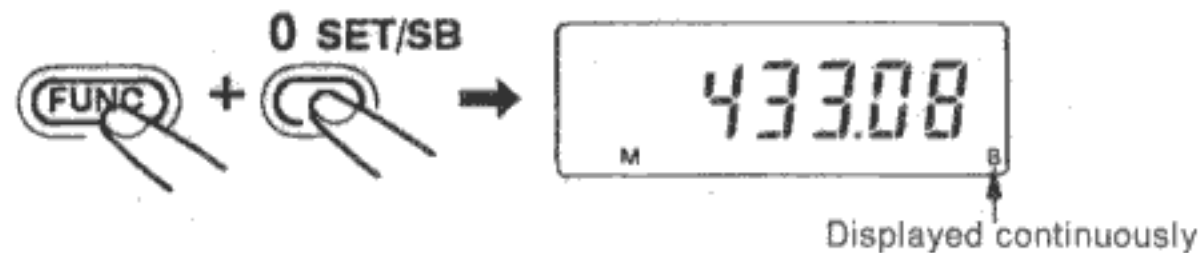

### (2) Pause scan

#### PROCEDURE

- 1) During scan operation with the B indication displayed, hold down the FUNC key and press the 0 SET S/B key. The B disappears from the display and pause scan is activated.



### (3) Hold scan

#### PROCEDURE

- 1) During scan operation, hold down the FUNC key and press the 9 REV/HSC key.  
The B indication flashes on and off and hold scan is activated.

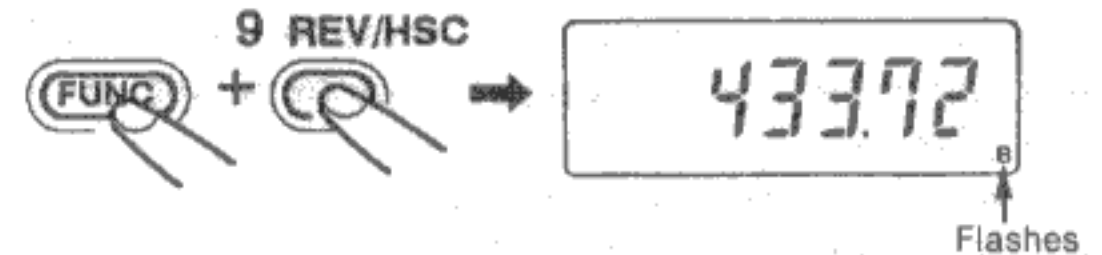

- 2) To cancel hold scan, hold down the FUNC key and press the 9 REV/HSC key again while the scan is in progress. The B disappears from the display and pause (busy) scan is activated.

---

**ADVICE**

- (1) Busy scan and pause scan can be set independently of VFO scan and memory scan.
- (2) Hold scan can be used together with VFO scan or memory scan.
- (3) During hold scan, switching between pause and busy scan is possible, but pause (busy) scan will not commence until hold scan is turned off.
- (4) Hold scan operation is not possible during tone frequency scan.
- (5) The order of precedence of the different scan types is as follows: hold scan > (busy scan = pause scan).

# CALL Operation

- The call memory is entirely independent of memory address numbers M00 ~ M39.
- The call frequency (referred to as the main channel) is set to 433.00 MHz (146.00 MHz in the case of the C168) when the unit is shipped from the factory.
- The CALL memory frequency can be changed if desired.

## Using the CALL key

### PROCEDURE

- 1) Press the CALL key.  
A pip (short high pitched beep) sounds and the call frequency appears on the display.

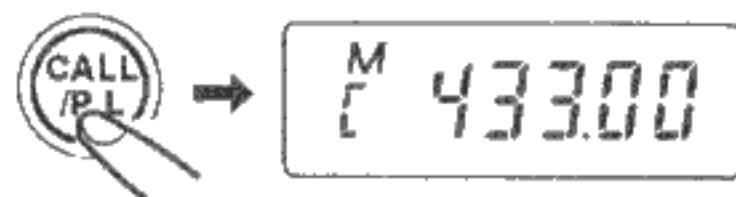

- 2) Press the CALL key a second time.  
A puff (short low pitched beep) sounds and the display returns to the status it was in before the CALL button was first pressed.

### ADVICE

- If the # CL PS key is pressed, the rotary channel selector turned, or the ▲ / ▼ keys pressed while the call frequency is being displayed, the VFO frequency replaces the call frequency.

## Changing the call frequency

### PROCEDURE

- 1) In the VFO mode, select the frequency you wish to assign to the CALL key.

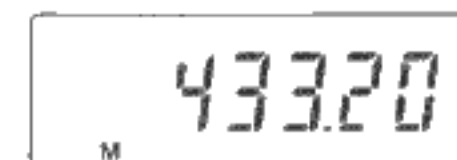

- 2) Hold down the FUNC key and press the B V/M ENT key.



- 3) Press the CALL key.  
A peep (long high pitched beep) sounds and the call frequency changes to the new frequency.

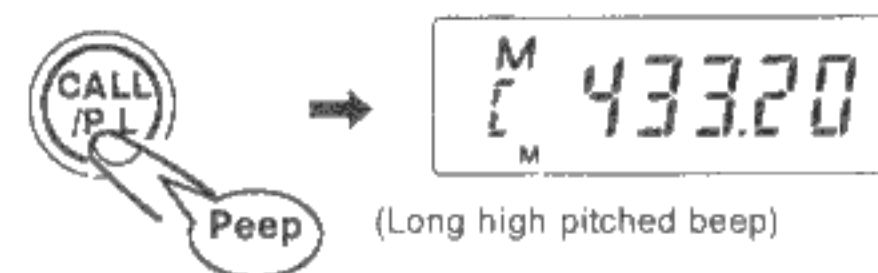

# Dual Watch Operation

## ■ Receiving signals on two frequencies alternately

This function is called dual watch. It allows you to monitor one of the memory frequencies (M00 ~ M39) or the call frequency and the VFO frequency alternately.

During dual watch operation, the memory frequency is received (and appears on the display) once every three seconds. This status is referred to as dual watch mode.

## ■ Dual watch operation types

■ The following four types of dual watch operation are possible.

- (1) The M00 frequency and VFO frequency
- (2) A memory address number of your choice and the VFO frequency
- (3) The call frequency and VFO frequency
- (4) Memory scan and the VFO frequency  
(See page 40 for details of the memory scan function.)

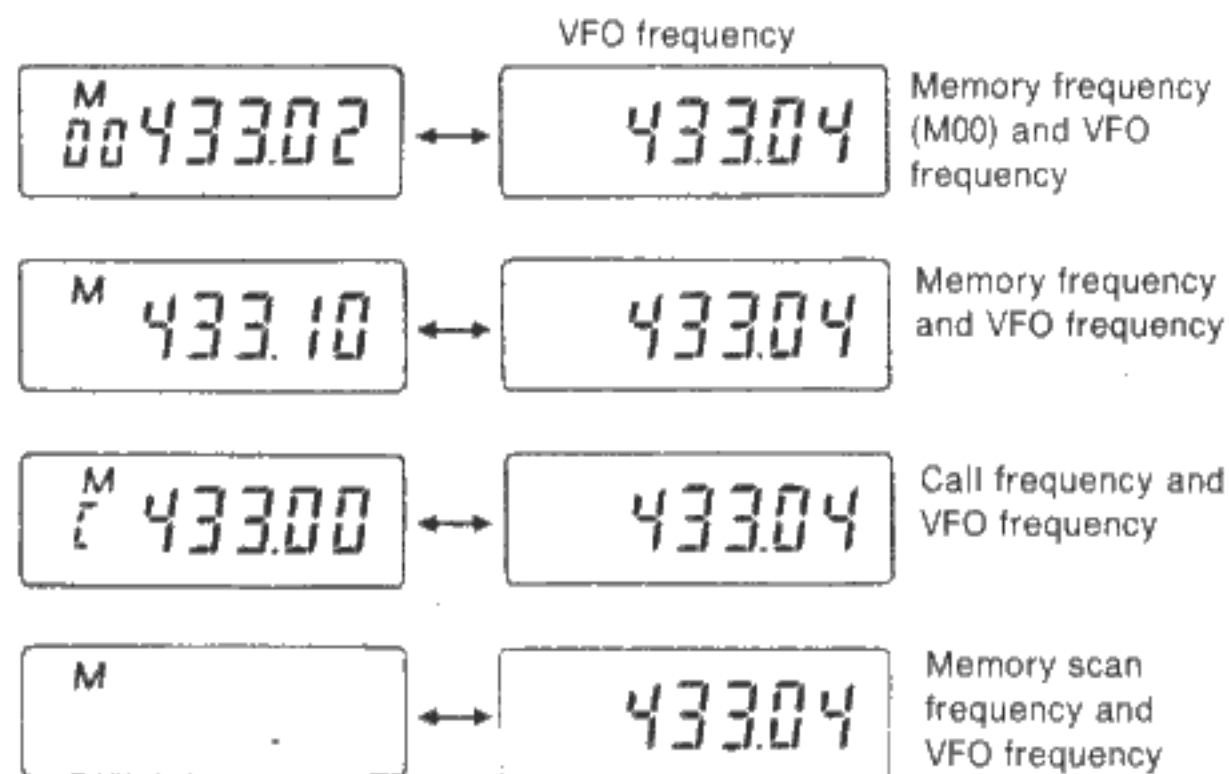

## ■ Using the dual watch function

- (1) The M00 frequency and VFO frequency

### PROCEDURE

- 1) Store one of the frequencies you wish to use for a dual watch operation in memory.

M00 frequency

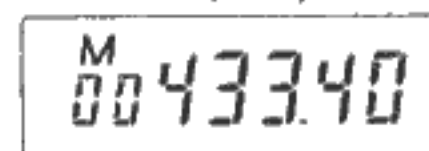

- 2) In the VFO mode, select the other frequency.

VFO frequency

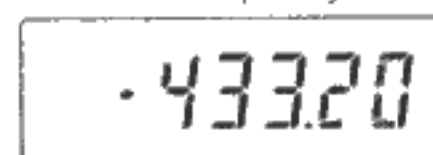

- 3) While still in the VFO mode, hold down the FUNC key and press the 2 DUAL key. The DUAL indication appears on the display and dual watch operation commences using the M00 frequency and the VFO frequency.

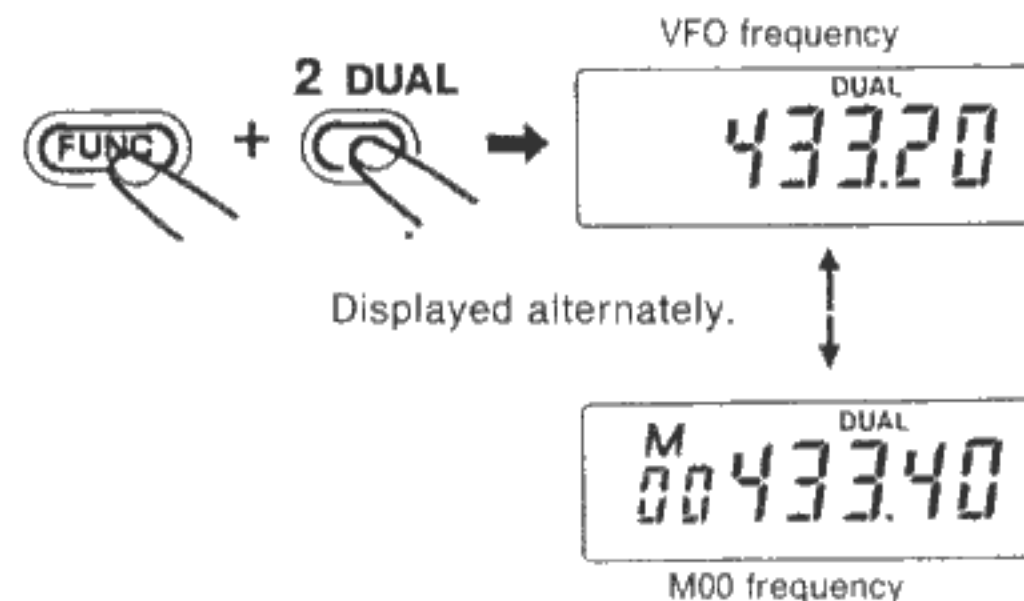

---

(2) A memory address number of your choice and the VFO frequency

**PROCEDURE**

- 1) In the VFO mode, select the first dual watch frequency.
- 2) In the memory mode, select the other frequency from among the memory address numbers with frequencies assigned. (Or store a frequency in memory.)
- 3) While still in the memory mode, hold down the FUNC key and press the 2 DUAL key.  
The DUAL indication appears on the display and dual watch operation commences using the memory address number frequency of your choice and the VFO frequency.

(3) The CALL frequency and VFO frequency

**PROCEDURE**

- 1) In the VFO mode, select the first dual watch frequency.
- 2) Press the CALL key.
- 3) Hold down the FUNC key and press the 2 DUAL key.  
The DUAL indication appears on the display and dual watch operation commences using the call frequency of your choice and the VFO frequency.

(4) Memory scan and the VFO frequency

**PROCEDURE**

- 1) In the VFO mode, select the first dual watch frequency.
- 2) Press the \* MS MS.M key to switch to the memory scan mode.
- 3) Hold down the FUNC key and press the 2 DUAL key.  
The DUAL indication appears on the display and memory scan takes place along with dual watch operation with the VFO frequency.

**ADVICE**

- (1) Dual watch operation will not commence if the memory address number selected is free.  
(A boo "long medium pitched beep" sounds.)
- (2) Dual watch operation is paused while the memory frequency is being received.  
(Dual watch recommences when the signal is lost.)
- (3) Dual watch operation is not paused while the VFO frequency is being received. This means that transmissions may be shut off midway, and is not a malfunction.

(5) Communicating during dual watch operation

**PROCEDURE**

- 1) To communicate on the VFO frequency, press the # CL PS key to cancel dual watch operation.
- 2) To communicate on the memory frequency, press the B V/M ENT key two times to switch to the memory mode.



# DTMF Operation

## DTMF memory function

- You can store strings of up to 15 characters including 0 ~ 9, A ~ D, \* and # in memory for later transmission as DTMF codes.
- There are 10 DTMF memory address numbers numbered 0 ~ 9.

### (1) DTMF memory display

#### Input example

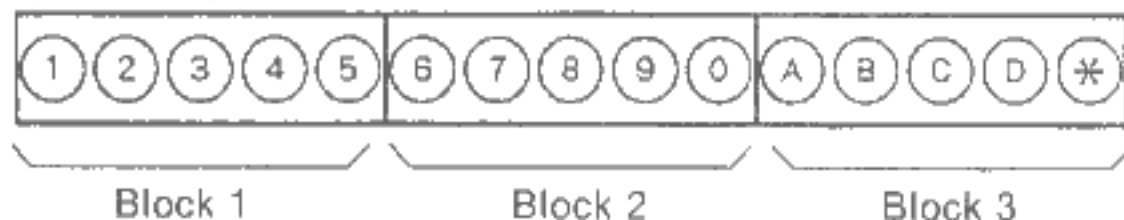

- The 15 column DTMF memory address numbers are each divided into three blocks of five columns.
- The blocks can be displayed one at a time. The block indicator shows which block, 1, 2 or 3, is being displayed.

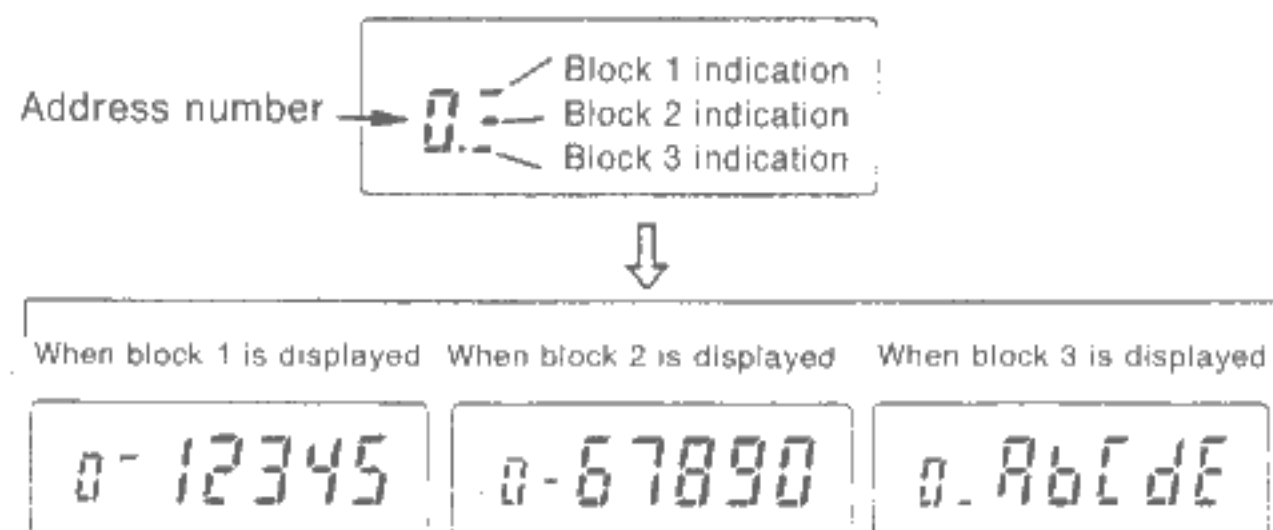

## DTMF memory display

### PROCEDURE

- 1) Hold down the FUNC key and press the SQL OFF key. The last DTMF memory address number used is displayed. (The DTMF memory address number is set to 0 when the unit is shipped from the factory.) Block one is displayed.

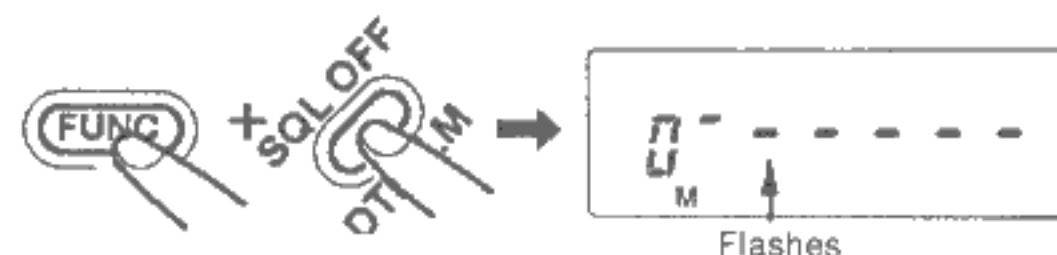

- 2) Select the desired DTMF memory address number using the rotary channel selector. A puff (short low pitched beep) sounds at DTMF memory address number 0. The ▲/▼ keys cannot be used to select DTMF memory address numbers because they are used as the C and D keys for this function.
- 3) Input the code to be stored in memory using the numeric keys. The \* character is displayed as an [E] and the # as an [F].
- 4) When input is finished, hold down the FUNC key and press the B V/M ENT key. The code is stored in memory. If you input a code a full 15 characters long, a peep (long high pitched beep) sounds when the 15th character is entered and the code is stored in memory automatically. In this case there is no need to perform step 4).
- 5) To return to the frequency display, hold down the FUNC key and press the SQL OFF key.

**NOTE**

(1) Do not perform step 4) above if you input a code a full 15 characters long.

Performing step 4) in this case will delete the code from memory.

**ADVICE**

(1) You can move the cursor by holding down the FUNC key and pressing the ▲/▼ key.

## ■ Deleting DTMF memory address number entries

**PROCEDURE**

- 1) Select the DTMF memory address number you wish to delete using the rotary channel selector.
- 2) Confirm that the leftmost digit of block one is flashing. If not, hold down the FUNC key and press the ▲/▼ key as appropriate to cause the leftmost digit of block one to flash.
- 3) Hold down the FUNC key and press the B V/M ENT key. A peep (long high pitched beep) sounds and the code is erased from memory. The display changes as follows.



## ■ Transmitting DTMF memory codes

**PROCEDURE**

- 1) Press the PTT switch.
- 2) With the PTT switch held down, press SQL OFF to blank the frequency display. (Do not press the FUNC key.)
- 3) With the PTT switch still held down, press the numeric key corresponding to the DTMF memory code you wish to transmit.

The DTMF memory code you selected is transmitted and appears on the display.



- 4) Release the PTT switch.

**NOTES**

- (1) Be sure to keep the PTT switch held down until step 3) above is finished.
- (2) Once transmission of the DTMF memory code begins, the PTT switch can be released with no ill effects. (The full DTMF memory code will be sent regardless.)

## Additional Functions (Functions Accessed by Holding Down the FUNC Key and Pressing Another Key)

- A number of functions are available in addition to those described in the preceding pages. They can be accessed by pressing special key combinations.
- The following functions can be accessed by pressing numeric keys while holding down the FUNC key. (Refer to the basic operation instructions on page 9.)

### Transmission power switching

- The transmission power level can be switched in the following sequence: (H) high, (M) medium, (L) low. Choose the transmission power level appropriate to the application.  
High .....High output power  
Medium ...Medium output power  
Low .....Low output power

#### PROCEDURE

- 1) Hold down the FUNC key and press the 1 PO key. The M on the display changes to an L, indicating low power.

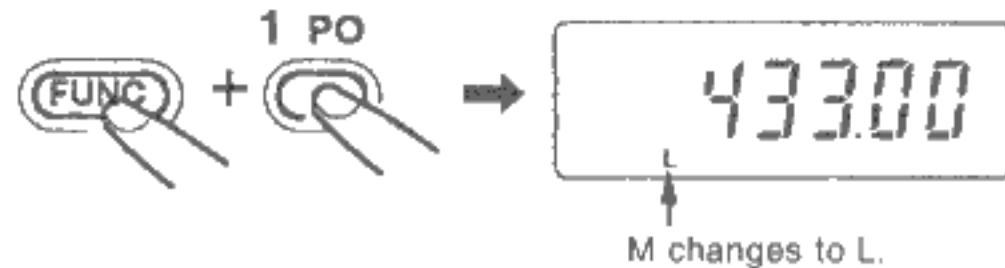

- 2) Holding down the FUNC key and pressing the 1 PO key again causes the L indication to change to an H, for high power.

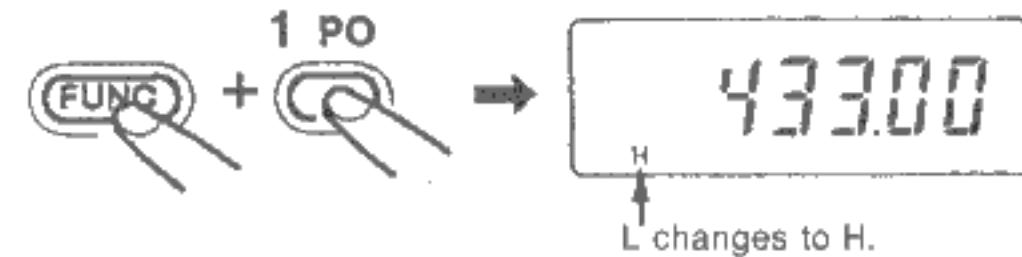

- 3) Holding down the FUNC key and pressing the 1 PO key once again causes the H to change back to an M, indicating medium power. A puff (short low pitched beep) sounds.

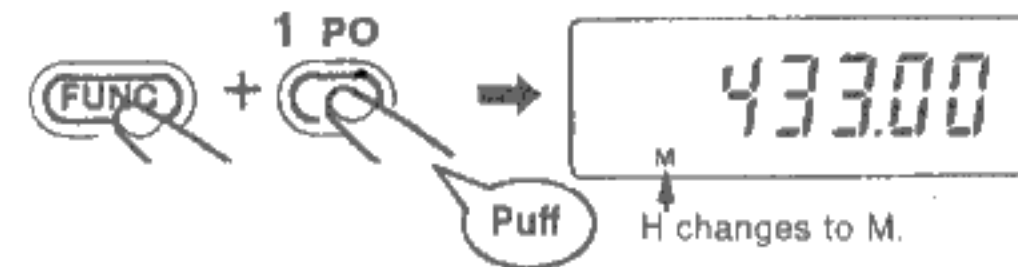

#### ADVICE

The power level setting is (M) medium when the unit is shipped from the factory.

## ■ Changing the tuning steps

- You can select the size of the tuning steps used when changing the frequency setting using the rotary channel selector or the ▲/▼ keys.

### PROCEDURE

- 1) Hold down the FUNC key and press the 4 STEP key.  
The current tuning step setting appears on the display.

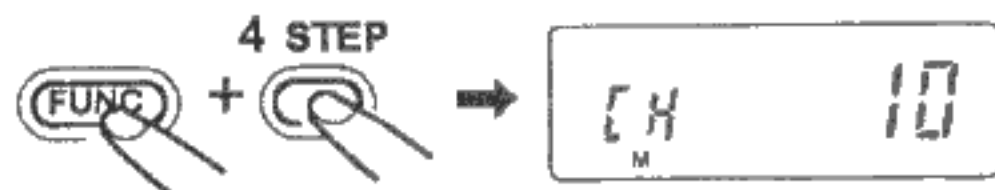

- 2) Turning the rotary channel selector at this point causes the display to change in the sequence 10 → 12.5 → 20 → 25 → 50 → 75 → 100 → 5 → 10. Select the tuning step setting of your choice.
  - A puff (short low pitched beep) sounds at the 5 kHz setting.
  - The ▲/▼ keys can also be used to select the tuning step setting.
- 3) After selecting the desired step setting, press the # CL PS key. The unit returns to the status it was in previous to tuning step setting.

## ■ Save operation

- This function reduces the amount of current consumed in receiving status. Leaving the transceiver in receiving status for an extended period of time will run down the batteries. When save operation is activated, the transceiver receives only at specified intervals a few seconds long.

### PROCEDURE

- 1) Hold down the FUNC key and press the 5 SAVE key.  
An S indication appears on the display, indicating save operation.

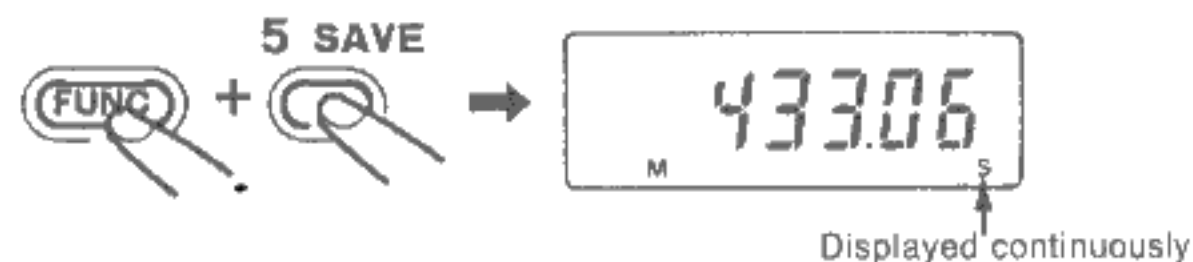

- 2) To cancel save operation, hold down the FUNC key and press the 5 SAVE key a second time. The S indication disappears from the display.

### ADVICE

- (1) The intervals between reception can be set to any of 10 different lengths. (Refer to page 59 for details.)

### NOTES

- (1) Save operation is not possible during dual watch operation or scan operation.
- (2) Always cancel save operation before activating the paging function.

## ■ Frequency lock

- This function disables key input to prevent errors caused by inadvertently pressing the wrong key while communicating with another station.

(Note that the rotary channel selector can be made to work even when frequency lock is on. See page 55.)

### PROCEDURE

- 1) Hold down the FUNC key and press the 6 F.L key. An FL appears on the display, indicating frequency lock.

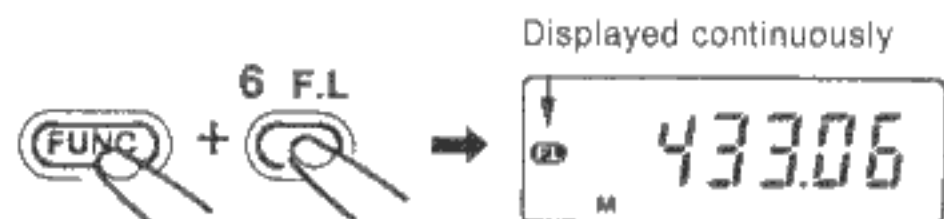

- 2) To cancel frequency lock, hold down the FUNC key and press the 6 F.L key a second time. The FL indication disappears from the display.

## ■ Turning on the display illumination lamp

### PROCEDURE

- 1) Hold down the FUNC key and press the LAMP key. The display illumination lamp lights continuously.
- 2) To turn off the display illumination lamp, hold down the FUNC key and press the LAMP key a second time.

### ADVICE

To turn on the lamp momentarily press only the lamp key.

## ■ Inhibiting the PTT switch

### PROCEDURE

- 1) Hold down the FUNC key and press the CALL/P.L key. A PL appears on the display, indicating that the PTT switch has been disabled.

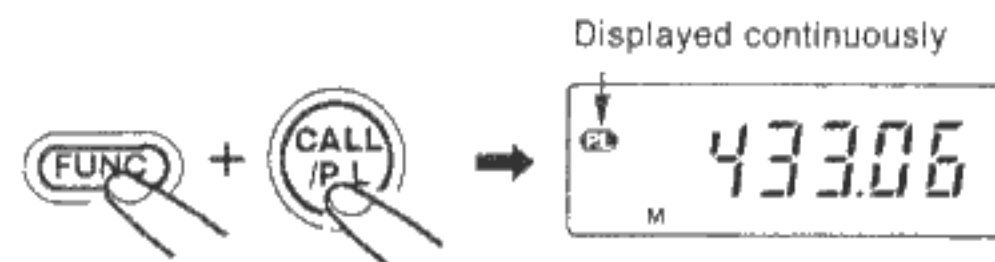

- 2) To re-enable the PTT switch, hold down the FUNC key and press the CALL/P.L key a second time.

## Additional Functions (Functions Accessed by Pressing Numeric Keys in the Set Mode)

- The following functions are added by switching to the set mode and pressing the numeric keys indicated. (Refer to the basic operation instructions on page 9.)

### ■ Beeper ON/OFF

- This function is used to turn off the beeps which normally sound when keys are pressed.

#### PROCEDURE

- 1) Switch to the set mode.
- 2) Press the 0 SET/SB key. The beeper is disabled.
- 3) To re-enable the beeper, again switch to the set mode and press the 0 SET/SB key. There is no display indication associated with this function.

### ■ Changing the length of the paging signal received alarm to one beep

- This function allows you to reduce the length of the paging signal received alarm to one series of beeps.

#### PROCEDURE

- 1) Switch to the set mode.
- 2) Press the 1 PO key.  
Now, when a paging signal is received, the unit will alert you with one pip-pip-pip-pip (series of repeated high pitched beeps).
- 3) To restore the paging signal received alarm to five series of beeps, again switch to the set mode and press the 1 PO key.

### ■ Inputting the 1 kHz column from the keyboard

#### PROCEDURE

- 1) Switch to the set mode.
- 2) Press the 2 DUAL key.  
A [▶] indication appears on the display, indicating that 1 kHz column input is possible.

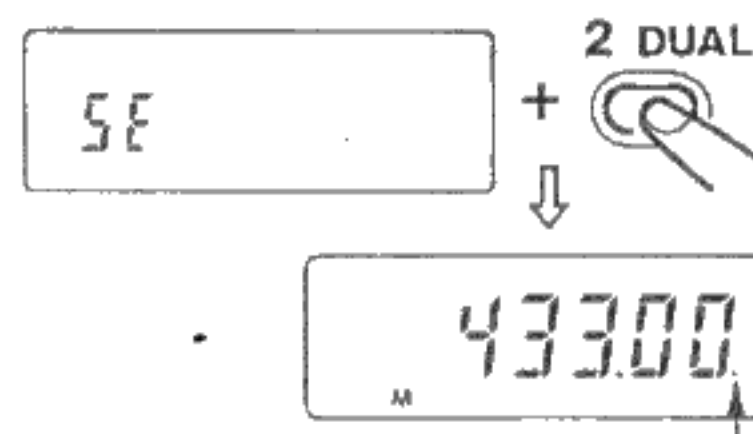

Displayed continuously

- 3) To cancel this function, again switch to the set mode and press the 2 DUAL key.  
The [▶] indication disappears.

## ■ Paging function for slow-access repeater stations

- This function increases the interval between when the PTT switch is pressed and when the paging signal is transmitted from 400 to 700 msec.

### PROCEDURE

- 1) Switch to the set mode.
- 2) Press the 3 SFT key.  
A pip (short high pitched beep) sounds, indicating that the interval has been increased to 700 msec.
- 3) To restore the interval to 400 msec., again switch to the set mode and press the 3 SFT key.  
A puff (short low pitched beep) sounds, indicating that the interval is now 400 msec. There is no display indication associated with this function.

## ■ Function for suppressing the pop noise when squelch opens

### PROCEDURE

- 1) Switch to the set mode.
- 2) Press the 4 STEP key.  
A pip (short high pitched beep) sounds, indicating that the function is on.
- 3) To cancel this function, again switch to the set mode and press the 4 STEP key.  
A puff (short low pitched beep) sounds, indicating that the function is off.

### NOTES

- (1) It is not possible to confirm whether this function is on or off by looking at the display.
- (2) When this function is on, current consumption increases slightly.

## ■ Auto power off (APO) function

- This function prevents the batteries from being discharged should you forget to switch the power off after using the unit.
- When this function is active, a pip-pip-pip-pip warning (repeated high pitched beeps) sounds if the unit is left unattended for approximately 30 minutes.
- Approximately one minute after the warning sounds, nearly all power is cut off automatically.  
This function is called auto power off (APO).

### PROCEDURE

- 1) Switch to the set mode.
- 2) Press the 5 SAVE key. An AP appears on the display, indicating that auto power off (APO) is on.

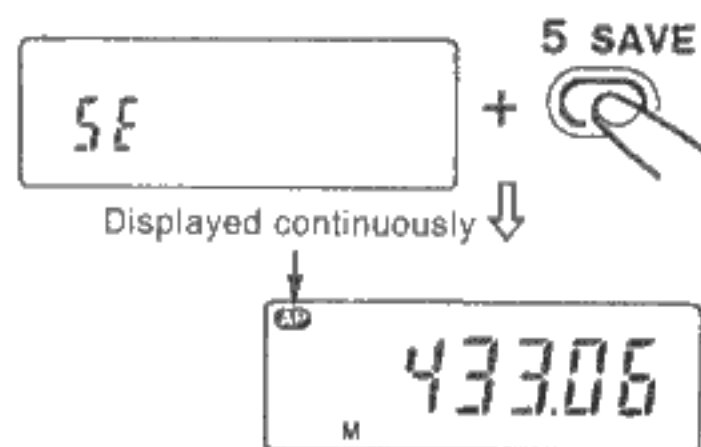

- 3) To cancel auto power off, again switch to the set mode and press the 5 SAVE key. The AP disappears from the display and auto power off is canceled.

## ■ Recovering from auto power off status

- After auto power off is triggered, the display goes blank. To cancel this status (return to normal operating status), either press one of the 0 ~ 9 or A ~ F keys, or switch power off and then back on again.

### NOTE

*Auto power off reduces current consumption to the minimum level. However, as current is still flowing through a portion of the electronic circuitry, auto power off status is not really equivalent to switching the power off manually. To turn the unit completely off, use the power switch.*

## ■ Function allowing use of the rotary channel selector even when frequency lock is turned on

- Many of the operation keys are disabled when frequency lock is on. This function allows use of the rotary channel selector even when frequency lock is active.

### PROCEDURE

- 1) Switch to the set mode.
- 2) Press the 6 F.L key.  
Now the rotary channel selector will still work even if frequency lock is turned on.
- 3) To cancel this function, again switch to the set mode and press the 6 F.L key. A puff (short low pitched beep) sounds, indicating that the function is off.

### NOTE

*If the above operation is performed when the unit is in the frequency lock mode, a boo (long medium pitched beep) sounds and the function is not activated. Turn frequency lock off before using this function.*



## Additional Functions (Functions Accessed in the Set Mode by Holding Down the FUNC Key and Pressing Another Key)

### All reset

- Perform the following steps to restore the factory settings. This function can be used to erase all memory entries or to restore normal operation if repeatedly switching the power on and off is not sufficient.

#### PROCEDURE

- 1) Switch to the set mode.
- 2) Hold down the FUNC key and press the 3 SFT key.  
A dot appears in the lower left portion of the display (to the right and below where the 1's column of the memory address number is displayed), indicating that the unit is ready for all reset.

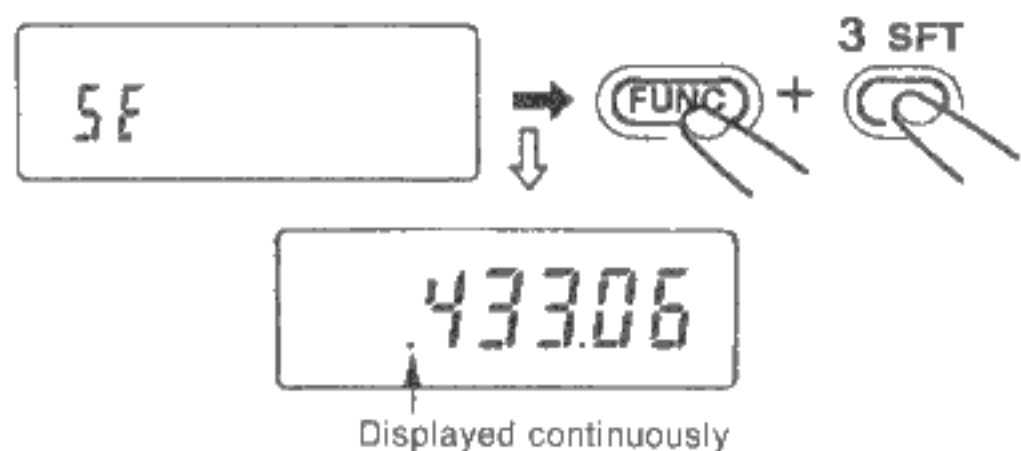

- 3) Switch to the set mode.
- 4) Hold down the FUNC key and press the 1 PO key.  
No pip (short high pitched beep) sounds.  
The display is blanked briefly while the factory settings are restored, then 433.00 MHz appears on the display. (On the C168, 146.00 MHz appears on the display.)

#### ADVICE

- (1) If the unit's microprocessor seems to be malfunctioning, switch the power off and then on again. This will restore normal operation in most cases.
- (2) If repeatedly switching the power on and off is not sufficient, it is possible that the contents of the unit's memory have been corrupted. Perform all reset. Refer to page 61 for more information.

### Protect mode

- This mode protects most of the contents of memory from alteration.
- Unlike the frequency lock function, the status of this mode is indicated on the display.

#### PROCEDURE

- 1) Switch to the set mode.
- 2) Hold down the FUNC key and press the 4 STEP key.  
A [ . ] dot appears in the lower left portion of the display (in the middle of where the memory address number is displayed), indicating that protect mode is active.  
If an attempt is made to change the contents of a memory address number when this mode is active, a boo (long medium pitched beep) sounds and the change is not allowed.
- 3) To cancel this mode, again switch to the set mode and press the 4 STEP key while holding down the FUNC key. A puff (short low pitched beep) sounds and protect mode is canceled.

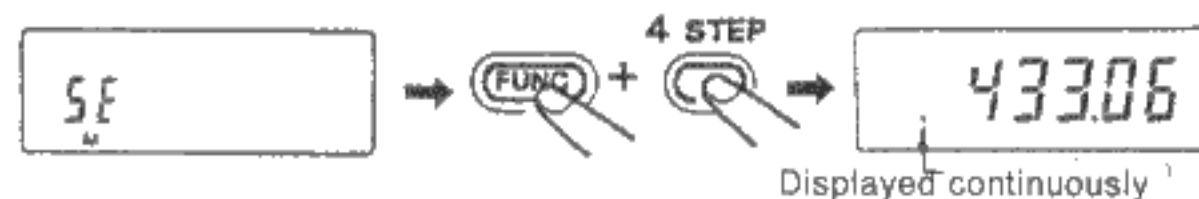

## ■ Squelching audio output even if the paging code matches

- When this function and the paging function are active and a matching paging code is received, only the pip-pip-pip-pip alarm (repeated high pitched beeps) sounds. Audio output is squelched.

### PROCEDURE

- 1) Switch to the set mode.
- 2) Hold down the FUNC key and press the 5 SAVE key. A pip (short high pitched beep) sounds, indicating that the function is on.
- 3) To cancel this function, again switch to the set mode and press the 5 SAVE key while holding down the FUNC key. A puff (short low pitched beep) sounds and the function is cancelled.

## ■ Changing the tuning steps used when the rotary channel selector is turned with the FUNC key depressed.

- If the FUNC key is held down and the rotary channel selector turned, the frequency changes in 100 kHz steps. The tuning step size can be changed to 1 MHz if desired.

### PROCEDURE

- 1) Switch to the set mode.
- 2) Hold down the FUNC key and press the 6 F.L key. A pip (short high pitched beep) sounds, indicating that the 1 MHz steps have been selected.



- 3) To restore 100 kHz steps, again switch to the set mode and press the 6 F.L key while holding down the FUNC key. A peep (long high pitched beep) sounds and the 100 kHz tuning step size is restored.

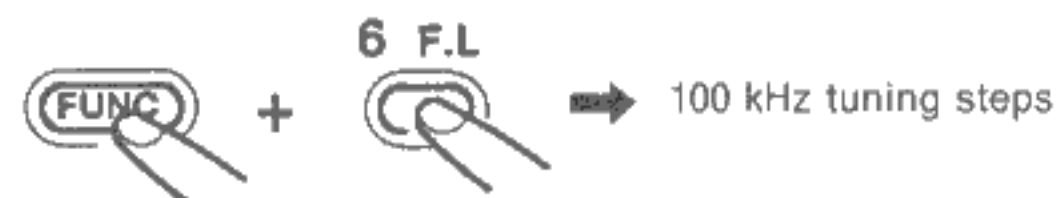

## ■ Clone mode

- This function allows you to copy the contents of your transceiver's memory to the memory of another transceiver using DTMF codes.
- A maximum of approximately four minutes is required for copying.

### PROCEDURE

- 1) Switch to the set mode.
- 2) Hold down the FUNC key and press the 7 T.SQ DM key. No pip (short high pitched beep) sounds. The clone mode is activated.
- 3) Press the PTT switch to transmit the contents of the transceiver's memory as DTMF codes.  
If such a transmission is received while in the clone mode, your transceiver's memory is overwritten with the data received.
- 4) When receiving (transmission) is finished, the unit returns to the normal operating mode.

### NOTES

- (1) While clone mode is active, if you perform another operation in the gaps between when DTMF signals received (or sent), clone mode is canceled automatically.
- (2) The control keys do not function while receiving (or sending) in the clone mode.
- (3) If the power switch is turned off while receiving (or sending) in the clone mode, the unit's proper operation cannot be guaranteed.
- (4) The unit's proper operation cannot be guaranteed if the contents of memory were not copied correctly and completely.

## ■ Bank switching when using the optional CMU161 memory unit

- The optional CMU161 memory unit increases the number of memory channels to 100. Using this function you can switch between two groups of channels, A and B, for a total of 200.
- The 100 group A channels and 100 group B channels are completely independent.
- The VFO and call frequencies, as well as the various function settings, are also independent for group A and group B.
- If the standard CMU160 memory unit is installed, performing the steps below will only cause a boo (long medium pitched beep) to sound.

### PROCEDURE

- 1) Switch to the set mode.
- 2) Hold down the FUNC key and press the 9 REV HSC key. No pip (short high pitched beep) sounds. The display is blanked briefly, then reappears with the current group B status. An E indication appears on the display when group B is in use.

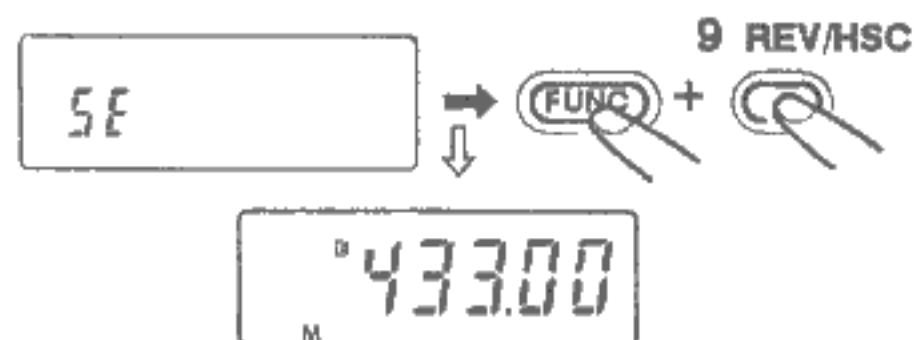

- 3) To return to the 100 group A channels, again switch to the set mode and press the 9 REV HSC key while holding down the FUNC key. The E indication disappears from the display and the 100 group A channels are again accessible.

## Additional Functions (Extra Mode)

- It is not necessary to hold down the FUNC key when pressing keys in the extra mode.

### PROCEDURE

- 1) Switch to the extra mode.
- 2) Hold down the FUNC key and press the 0 SET/SB key. An [EA] indication appears on the display to show that the extra mode is active. (EA stands for EXTRA.)

## ■ High speed scan

- The scan speed can be set to either 150 msec./channel for normal scan and 250 msec./channel for memory scan or 60 msec./channel for normal scan and 120 msec./channel for memory scan. Due to the intelligent scan function, the actual scan speed may be slight slower.

### PROCEDURE

- 1) Switch to the extra mode.
- 2) Press the 1 PO key.  
A pip (short high pitched beep) sounds and the high speed scan function is activated.  
When high speed scan is on, two dots flash during scan operation.

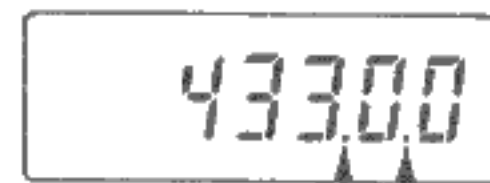

Two dots flash during scan.

- 3) To restore the normal scan speed, again switch to the extra mode and press the 1 PO key.  
A puff (short low pitched beep) sounds and the normal scan speed is restored.

## ■ High speed dual watch

- The dual watch function normally monitors the VFO frequency for three seconds, followed by 0.25 seconds of the memory frequency. High speed dual watch reduces these times to 600 msec. for both the VFO and memory frequencies.

### PROCEDURE

- 1) Switch to the extra mode.
- 2) Press the 2 DUAL key.  
A pip (short high pitched beep) sounds and the high speed dual watch function is activated.
- 3) To restore normal dual watch, again switch to the extra mode and press the 2 DUAL key.  
A puff (short low pitched beep) sounds and the high speed dual watch function is cancelled.

## ■ Selecting the save interval

- There are 10 save interval settings to choose from. The available save intervals are 0.25, 0.5, 0.75, 1.0, 1.5, 2.0, 3.0, 5.0, 7.0 and 10.0 seconds.
- The save interval is set to 0.75 seconds when the unit is shipped from the factory.

### PROCEDURE

- 1) Switch to the extra mode.
- 2) Press the 4 STEP key.

The current save interval is displayed. A SA indication appears on the display during the save interval setting process.

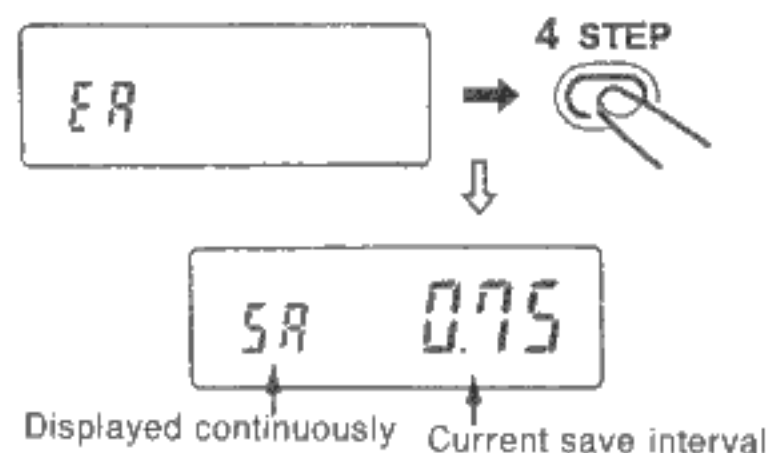

- 3) Select the desired save interval using the ▲/▼ keys or the rotary channel selector. A puff (short low pitched beep) sounds at the 0.75 setting.
- 4) After selecting the save interval, press the # CL PS key.
- 5) The save interval setting function is cancelled automatically.

## ■ Increasing the DTMF signal transmission interval

- DTMF signals are normally transmitted with an interval of 50 msec. between digits. This function increases the interval to 100 msec.

### PROCEDURE

- 1) Switch to the extra mode.
- 2) Press the 5 SAVE key.  
A pip (short high pitched beep) sounds and the interval is set to 100 msec.
- 3) To restore normal 50 msec. interval, again switch to the extra mode and press the 5 SAVE key.  
A puff (short low pitched beep) sounds and the DTMF signal transmission interval is restored to 50 msec.

### NOTE

- This setting affects the paging, code squelch, DTMF and memory functions.

## ■ Inputting frequencies from the 100 MHz column

### PROCEDURE

- 1) Switch to the extra mode.
- 2) Press the 8 RPT key.  
A [ ◀ ] indication appears on the display and frequency input from the 100 MHz column is enabled.

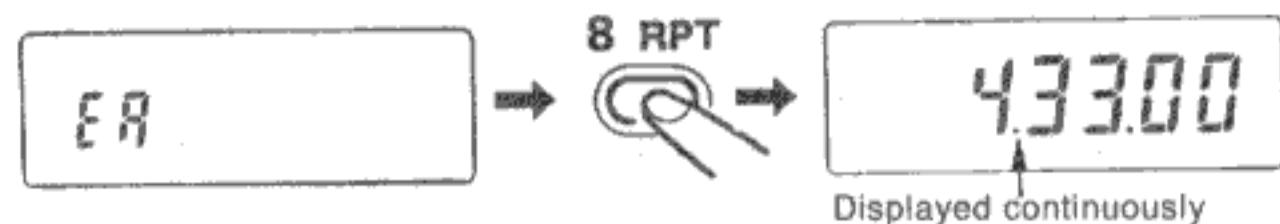

- 3) To return to the previous status, again switch to the extra mode and press the 7 T SQ DM key. The [ ◀ ] indication disappears and frequency input from the 1 MHz column is restored.

# Troubleshooting

---

- ★ Frequency display is faint (dark).
- ☆ The entire display becomes fainter as the batteries run down.  
(Replace batteries.)
- ★ The factory settings are restored every time the power is turned off and then on again.
- ☆ Confirm that the CMU160 or CMU161 is properly installed.
- ★ Can't receive signals.
- ☆ Press the SQL OFF button and check whether sound issues from the speaker.
- ☆ Is the squelch knob turned all the way clockwise?  
(Turn it counterclockwise.)
- ☆ Is tone squelch turned on?  
(Turn it off.)
- ☆ Is the volume knob turned all the way counterclockwise?  
(Turn the volume knob clockwise until the desired volume setting is reached.)
- ☆ Is the paging or code squelch function turned on?  
(Turn paging or code squelch off.)
- ★ Can only receive strong signals.
- ☆ Is the included antenna mounted properly?  
(Mount properly.)
- ☆ Is the squelch knob turned all the way clockwise?  
(Turn it counterclockwise.)
- ★ Can't transmit.
- ☆ Was the transmit indicator dim when the PTT button was pressed?  
(Replace batteries.)
- ☆ Is there a "P.L" indication visible on the display?  
(Hold down the FUNC button and press the CALL key to cancel PTT lock.)
- ★ Can only transmit on the call frequency.
- ☆ Is there a C indication visible on the display?  
(Press the CALL button again to return to the dial frequency.)
- ★ The unit transmits on a frequency other than the one displayed.
- ☆ Is a [ + ] or [ - ] indication displayed continuously?  
(The send and receive frequencies are different during repeater operation.)
- ★ Can't change the frequency.
- ☆ Is a F.L indication displayed continuously?  
(Hold down the FUNC button and press the 6 key to cancel frequency lock.)
- ★ Beeper doesn't sound.
- ☆ Is the beeper turned off?  
(Switch to the set mode and press the 0 key to turn the beeper back on.)
- ☆ Is the volume knob turned all the way counterclockwise?  
(Turn the volume knob clockwise until the desired volume setting is reached.)

- 
- ★ Can only change frequencies using the rotary channel selector.
  - ☆ Is there a F.L indication visible on the display?  
(Hold down the FUNC button and press the 6 key to cancel frequency lock.)
  
  - ★ Can't store data in memory.
  - ☆ Is the CMU160 (CMU161) properly installed?
  - ☆ Is the unit in the protect mode?
  - ☆ The CMU160 or CMU161 may be defective.  
Contact your dealer for assistance.
  
  - ★ All reset function doesn't work.
  - ☆ Check the following points.
    1. Is there a F.L (frequency lock) indication visible on the display?  
Hold down the FUNC button and press the 6 F.L key to cancel frequency lock.
    2. Is the protect mode turned on?  
If the protect mode dot [ · ] appears on the display, switch to the set mode and press the 4 STEP key while holding down the FUNC key.



# Specifications

## ● General Specifications

Frequency range .....	144.00 – 147.995 MHz (C168) 430.00 – 439.995 MHz (C468)
Radio wave type .....	F3
Microphone input impedance .....	600 Ω
Speaker impedance .....	8 Ω
Operating voltage range .....	6 – 16 V (using external power supply jack)
Rated voltage .....	7.2 V
Current consumption .....	Transmitting : 13.8 V
High (5 W) .....	Approx. 1,300 mA (C468) Approx. 1,000 mA (C168)
Medium (2.5 W) .....	Approx. 950 mA (C468) Approx. 800 mA (C168)
Transmitting : 7.2 V	
High/medium (2 W) .....	Approx. 900 mA (C468)
(2.5 W) .....	Approx. 900 mA (C168)
Transmitting : 13.8/7.2 V :Low (350 mW) .....	Approx. 450 mA (C468) Approx. 400 mA (C168)
Receiving .....	Approx. 38 mA (C468) Approx. 32 mA (C168)
Battery save operation .....	Approx. 13 mA (C468) Approx. 12 mA (C168)
Auto power off (APO) operation .....	Approx. 0.5 mA
Body dimensions (excluding protrusions) .....	47 W x 120 H x 31 D mm
Weight .....	290 g (including antenna and batteries)

## ● Reception

Reception type .....	Double super heterodyne
Intermediate frequencies ....	1st IF: 30.85 MHz (C168), 2nd IF: 455 kHz 1st IF: 23.05 MHz (C468), 2nd IF: 455 kHz
Reception sensitivity .....	0.158 μV
S/N ratio with 0.5 μV input .....	Min. 30 dB
Squelch open sensitivity .....	0.1 μV
Audio output .....	200 mW (8 Ω, 10% distortion)

## ● Transmission

Output power .....	High	With CBT160 .....	1.0 W (C468) 1.0 W (C168)
		With CNB160 .....	1.5 W
		With CNB161/163 .....	2.0 W (C468) 2.5 W (C168)
		With CNB162 .....	5.0 W (C468) 5.0 W (C168)
	Medium	With CBT160 .....	1.0 W (C468)
		With CNB160 .....	1.5 W (C468) 1.5 W (C168)
		With CNB161/163 .....	2.0 W (C468) 2.5 W (C168)
		With CNB162 .....	2.5 W (C468) 2.5 W (C168)
	Low .....		0.35 W
Modulation method .....	Reactance modulation		
Maximum frequency deviation .....	±5 kHz		
Spurious ratio .....	60 dB		
Built-in microphone .....	Electret condenser type		

The specifications and external appearance of the unit are subject to change without notice due to product improvements.

Downloaded by □



Amateur Radio Directory