

u-blox 5

Receiver Description

Including Protocol Specification

Abstract

The Receiver Description Including Protocol Specification describes the firmware features, specifications and configuration for u-blox 5 high performance GPS receiver modules.

u-blox 5 firmware includes many features and configuration settings to customize receiver behavior to the user's specific needs.

The Receiver Description provides an overview and conceptual details of the supported features.

The Protocol Specification details the NMEA and UBX protocols and serves as a reference tool.

Document Information

Title	u-blox 5 Receiver Description
Subtitle	Including Protocol Specification
Document type	Manual
Document number	GPS.G5-X-07036-G 36880M, 27 Nov 2009
Document status	Revision for FW 6.02 (Public Release)

This document and the use of any information contained therein, is subject to the acceptance of the u-blox terms and conditions. They can be downloaded from www.u-blox.com. u-blox makes no warranties based on the accuracy or completeness of the contents of this document and reserves the right to make changes to specifications and product descriptions at any time without notice. u-blox reserves all rights to this document and the information contained herein. Reproduction, use or disclosure to third parties without express permission is strictly prohibited. Copyright © 2009, u-blox AG.

Table of Contents

Receiver Description	1
Overview	1
Antenna / Antenna Supervision	1
Serial Communication Ports Description	1
How to Change Between Protocols	1
NMEA Protocol Configuration	1
Forcing a Receiver Reset	1
Geodetic Datum	1
Timing	2
Receiver Configuration	2
Power Management	2
Navigation and SBAS	2
Remote Inventory	2
System	2
Acquisition and Aiding	2
Serial Communication Ports Description	3
UART Ports.....	3
USB Port.....	4
DDC Port.....	4
Read Access	4
Random Read Access	5
Current Address Read.....	6
Write Access	6
SPI Port.....	7
Read Access	7
Back-To-Back Read and Write Access	8
How to change between protocols.....	8
Forcing a Receiver Reset	8
Timepulse Configuration	9
Receiver Configuration	12
Configuration Concept	12
Organization of the Configuration Sections.....	13
Permanent Configuration Storage Media	13
Receiver Default Configuration	14
Power Management	14
Maximum Performance Mode	14
Eco Mode.....	14
Power Save Mode	14
Configuring Power Save Mode	15
Update-, search period & grid offset.....	15

Long update periods	16
Short updates periods	16
Infinite periods.....	16
Acquisition timeout & ON-Time	16
Maintain fast start-up.....	16
Communication & wake-up.....	17
Pin Control.....	17
FixNow Interface	17
Default settings.....	18
Operation	18
Satellite Data Download	19
Expected GPS Performance	20
Peak Current Reduction.....	20
Power On/Off command.....	20
SBAS Configuration Settings Description	20
SBAS (Satellite Based Augmentation Systems).....	20
SBAS Features.....	22
SBAS Configuration	23
NMEA Protocol Configuration	24
Time Mode Configuration	24
Introduction	24
Fixed Position	25
Survey-in	25
Navigation Configuration Settings Description	25
Platform settings.....	25
Navigation Input Filters	26
Navigation Output Filters.....	27
Static Hold	27
Degraded Navigation	27
2D Navigation	28
Dead Reckoning, Extrapolating Positioning	28
Remote Inventory.....	28
Description	28
Usage	28
Receiver Status Monitoring	29
Input/Output system	29
Jamming/Interference Indicator.....	30
Aiding and Acquisition	30
Introduction	30
Startup Strategies	30
Aiding / Assisted GPS (AGPS).....	30
Aiding Data	31
Aiding Sequence	31
AssistNow Online	31

AssistNow Offline.....	32
Host-based AlmanacPlus Overview	33
Message specifics	33
Range checks.....	34
Changing ALP files.....	34
Sample Code.....	34
Flash-based AlmanacPlus Overview	34
Download Procedure.....	35
Timemark.....	35
NMEA Protocol	37
Protocol Overview.....	37
Latitude and Longitude Format.....	38
Position Fix Flags in NMEA Mode.....	39
NMEA Messages Overview	40
Standard Messages.....	41
GGA.....	41
GLL	43
GSA	44
GSV.....	45
RMC.....	46
VTG	47
GRS.....	48
GST	49
ZDA	50
GBS.....	51
DTM	52
GPQ	53
TXT	54
Proprietary Messages.....	55
UBX,00	55
UBX,03	57
UBX,04	59
UBX	60
UBX,40	61
UBX,41	62
UBX Protocol.....	63
UBX Protocol Key Features	63
UBX Packet Structure	63
UBX Class IDs	63
UBX Payload Definition Rules	64
Structure Packing	64
Message Naming.....	64
Number Formats	64
UBX Checksum.....	65

UBX Message Flow	65
Acknowledgement.....	65
Polling Mechanism.....	65
UBX Messages Overview.....	66
NAV (0x01).....	69
NAV-POSECEF (0x01 0x01)	69
Position Solution in ECEF.....	69
NAV-POSLLH (0x01 0x02).....	69
Geodetic Position Solution	69
NAV-STATUS (0x01 0x03).....	70
Receiver Navigation Status.....	70
NAV-DOP (0x01 0x04)	71
Dilution of precision	71
NAV-SOL (0x01 0x06)	72
Navigation Solution Information.....	72
NAV-VELECEF (0x01 0x11)	73
Velocity Solution in ECEF.....	73
NAV-VELNED (0x01 0x12)	74
Velocity Solution in NED.....	74
NAV-TIMEGPS (0x01 0x20).....	74
GPS Time Solution.....	74
NAV-TIMEUTC (0x01 0x21)	75
UTC Time Solution	75
NAV-CLOCK (0x01 0x22)	76
Clock Solution	76
NAV-SVINFO (0x01 0x30)	77
Space Vehicle Information	77
NAV-SBAS (0x01 0x32)	79
SBAS Status Data.....	79
RXM (0x02)	81
RXM-RAW (0x02 0x10)	81
Raw Measurement Data	81
RXM-SFRB (0x02 0x11)	82
Subframe Buffer.....	82
RXM-SVSI (0x02 0x20)	82
SV Status Info	82
RXM-ALM (0x02 0x30)	84
Poll GPS Constellation Almanach Data.....	84
Poll GPS Constellation Almanach Data for a SV.....	84
GPS Aiding Almanach Input/Output Message	85
RXM-EPH (0x02 0x31).....	85
Poll GPS Constellation Ephemeris Data	85
Poll GPS Constellation Ephemeris Data for a SV.....	86
GPS Aiding Ephemeris Input/Output Message.....	86

RXM-POSREQ (0x02 0x40).....	87
Request position fix in Power Management mode	87
RXM-PMREQ (0x02 0x41).....	87
Requests a Power Management task.....	87
INF (0x04)	89
INF-ERROR (0x04 0x00)	89
ASCII String output, indicating an error.....	89
INF-WARNING (0x04 0x01).....	89
ASCII String output, indicating a warning	89
INF-NOTICE (0x04 0x02)	90
ASCII String output, with informational contents.....	90
INF-TEST (0x04 0x03)	90
ASCII String output, indicating test output.....	90
INF-DEBUG (0x04 0x04).....	91
ASCII String output, indicating debug output	91
ACK (0x05)	92
ACK-NAK (0x05 0x00)	92
Message Not-Acknowledged	92
ACK-ACK (0x05 0x01).....	92
Message Acknowledged.....	92
CFG (0x06).....	93
CFG-PRT (0x06 0x00)	93
Polls the configuration of the used I/O Port	93
Polls the configuration for one I/O Port.....	93
Get/Set Port Configuration for UART	94
Get/Set Port Configuration for USB Port.....	95
Get/Set Port Configuration for SPI Port.....	97
Get/Set Port Configuration for DDC Port.....	98
CFG-MSG (0x06 0x01)	100
Poll a message configuration.....	100
Set Message Rate(s)	100
Set Message Rate	101
CFG-INF (0x06 0x02)	101
Poll INF message configuration for one protocol.....	101
Information message configuration	102
CFG-RST (0x06 0x04).....	103
Reset Receiver / Clear Backup Data Structures.....	103
CFG-DAT (0x06 0x06)	104
Poll Datum Setting.....	104
Set Standard Datum.....	104
Set User-defined Datum	105
Get currently selected Datum	105
CFG-TP (0x06 0x07).....	106
Poll TimePulse Parameters.....	106

Get/Set TimePulse Parameters.....	107
CFG-RATE (0x06 0x08).....	108
Poll Navigation/Measurement Rate Settings.....	108
Navigation/Measurement Rate Settings.....	108
CFG-CFG (0x06 0x09).....	109
Clear, Save and Load configurations	109
CFG-FXN (0x06 0x0E).....	110
Poll FXN configuration	110
RXM FixNOW configuration.	111
CFG-RXM (0x06 0x11).....	112
RXM configuration	112
CFG-ANT (0x06 0x13)	112
Poll Antenna Control Settings.....	112
Get/Set Antenna Control Settings.....	113
Get/Set Antenna Control Settings.....	114
CFG-SBAS (0x06 0x16)	115
SBAS Configuration	115
CFG-NMEA (0x06 0x17)	116
Poll the NMEA protocol configuration.....	116
Set/Get the NMEA protocol configuration.....	117
CFG-USB (0x06 0x1B).....	118
Poll a USB configuration.....	118
Get/Set USB Configuration	118
CFG-TMODE (0x06 0x1D)	119
Poll Time Mode Settings.....	119
Time Mode Settings.....	120
CFG-NAVX5 (0x06 0x23).....	120
Poll Navigation Engine Expert Settings.....	120
Get/Set Navigation Engine Expert Settings.....	121
CFG-NAV5 (0x06 0x24).....	122
Poll Navigation Engine Settings.....	122
Get/Set Navigation Engine Settings.....	122
CFG-PM (0x06 0x32)	124
Power Management configuration	124
CFG-RINV (0x06 0x34)	125
Set/Get contents of Remote Inventory	125
MON (0x0A)	127
MON-IO (0x0A 0x02)	127
I/O Subsystem Status.....	127
MON-VER (0x0A 0x04)	128
Receiver/Software Version.....	128
Receiver/Software/ROM Version	128
MON-MSGPP (0x0A 0x06)	129
Message Parse and Process Status.....	129

MON-RXBUF (0x0A 0x07).....	129
Receiver Buffer Status.....	129
MON-TXBUF (0x0A 0x08).....	130
Transmitter Buffer Status	130
MON-HW (0x0A 0x09).....	131
Hardware Status.....	131
Hardware Status.....	132
MON-HW2 (0x0A 0x0B)	133
Extended Hardware Status.....	133
MON-RXR (0x0A 0x21)	134
Receiver Status Information	134
AID (0x0B).....	135
AID-REQ (0x0B 0x00).....	135
Sends a poll (AID-DATA) for all GPS Aiding Data	135
AID-INI (0x0B 0x01)	135
Poll GPS Initial Aiding Data	135
Aiding position, time, frequency, clock drift	136
AID-HUI (0x0B 0x02).....	137
Poll GPS Health, UTC and ionosphere parameters.....	137
GPS Health, UTC and ionosphere parameters.....	138
AID-DATA (0x0B 0x10)	139
Polls all GPS Initial Aiding Data.....	139
AID-ALM (0x0B 0x30)	139
Poll GPS Aiding Almanac Data	139
Poll GPS Aiding Almanac Data for a SV.....	140
GPS Aiding Almanac Input/Output Message.....	140
AID-EPH (0x0B 0x31)	141
Poll GPS Aiding Ephemeris Data	141
Poll GPS Aiding Ephemeris Data for a SV	141
GPS Aiding Ephemeris Input/Output Message.....	142
AID-ALPSRV (0x0B 0x32)	142
ALP client requests AlmanacPlus data from server.....	142
ALP server sends AlmanacPlus data to client	143
ALP client sends AlmanacPlus data to server.	144
AID-ALP (0x0B 0x50)	144
ALP file data transfer to the receiver	144
Mark end of data transfer	145
Acknowledges a data transfer	145
Indicate problems with a data transfer	146
Poll the AlmanacPlus status.....	146
Poll the AlmanacPlus status.....	147
TIM (0x0D)	148
TIM-TP (0x0D 0x01)	148
Timepulse Timedata.....	148

TIM-TM2 (0x0D 0x03)	149
Time mark data	149
TIM-SVIN (0x0D 0x04)	150
Survey-in data	150
Appendix	151
u-blox 5 Default Settings	151
Antenna Supervisor Settings (UBX-CFG-ANT)	151
Datum Settings (UBX-CFG-DAT)	151
Navigation Settings (UBX-CFG-NAV5)	151
Navigation Settings (UBX-CFG-NAVX5)	152
Output Rates (UBX-CFG-RATE)	152
Fix Now Configuration (UBX-CFG-FXN)	152
Power Management Configuration (UBX-CFG-PM)	153
Receiver Manager Configuration (UBX-CFG-RXM)	153
SBAS Configuration (UBX-CFG-SBAS).....	153
Port Setting (UBX-CFG-PRT).....	154
Port Setting (UBX-CFG-USB)	154
Message Settings (UBX-CFG-MSG)	154
NMEA Protocol Settings (UBX-CFG-NMEA)	155
INF Messages Settings (UBX-CFG-INF)	155
Power Save Mode configuration settings (UBX-CFG-PM)	155
Timepulse Settings (UBX-CFG-TP)	156
u-blox 5 Standard firmware versions	156
Geodetic Datum	156
Predefined Datum.....	156
Ellipsoids	162
Rotation and Scale	163

Receiver Description

Overview

The Receiver Description Including Protocol Specification consists of 2 main sections: The Receiver Description and the Protocol Specification.

The Receiver Description describes the software aspects of system features and configuration of u-blox 5 technology, and is structured according to functionalities. Links are provided to the corresponding NMEA and UBX messages, which are described in the Protocol Specification. The Protocol Specification is organized by the specific NMEA and UBX messages.

A basic outline of the Receiver Description is provided below.

Antenna / Antenna Supervision

Antenna Supply and Antenna Supervision continue to be features supported by selected u-blox 5 receivers. These are described in the applicable Hardware Integration Manual for the specific receiver. The status is reported by the message [MON-HW](#) described in the Protocol Specification.

Serial Communication Ports Description

Serial Communication and the different communication ports supported by u-blox 5 technology are described in the section [Serial Communication Ports Description](#). The exact types and number of ports supported is specific to the receiver and Firmware versions used. Software configuration of these ports is done with [CFG-PRT](#) explained in the Protocol Specification.

How to Change Between Protocols

Reconfiguring a communication port from one protocol to another is explained in the section [How to Change Between Protocols](#). Software configuration is done with [CFG-MSG](#) explained in the Protocol Specification.

NMEA Protocol Configuration

Configuring the NMEA protocol is explained in the section [NMEA Protocol Configuration](#). This is done using [CFG-NMEA](#), described in the Protocol Specification.

Forcing a Receiver Reset

Forcing a software reset is described in the section [Forcing a Receiver Reset](#). A receiver reset can be initiated with [CFG-RST](#) explained in the Protocol Specification.

Geodetic Datum

The predefined Geodetic Datum values are listed in the section [Geodetic Datum](#).

Timing

Timepulse and timemark functions are detailed in section [Timepulse Configuration](#) and section [Timemark](#), respectively, and are configured with the message [CFG-TP](#) described in the Protocol Specification.

The special premium Timing features available only on selected modules are detailed in section [Time Mode Configuration](#) and are configured with the message [CFG-TMODE](#) described in the Protocol Specification.

Receiver Configuration

Information about configuration concept, organization and storage media is included in the section [Receiver Configuration](#) and relates to the message [CFG-CFG](#) in the Protocol Specification.

Power Management

u-blox 5 includes flexible power management strategies including 3 power modes: Maximum Performance Mode, Eco Mode and Power Save Mode. A description of these modes is provided in the section [Power Management](#). Power modes are selected with the message [CFG-RXM](#) and Power Save Mode is configured with [UBX-CFG-PM](#) described in the Protocol Specification.

Navigation and SBAS

A Description of Navigation Configuration Settings, Navigation Update Rate, and SBAS (Satellite Based Augmentation Systems) are described in the sections [Navigation Configuration Settings Description](#) and [SBAS Configuration Settings Description](#). These functions are activated and configured using the messages [CFG-NAV5](#), [CFG-SBAS](#), and [CFG-RATE](#) defined in the Protocol Specification.

Remote Inventory

A short description as well as the usage of this feature are provided in the section [Remote Inventory](#). It can be configured using the message [UBX-CFG-RINV](#).

System

System Functions such as Hardware Monitoring, Reset and Firmware Update are explained in the section [Receiver Status Monitoring](#) and are implemented with the messages [MON](#) and [CFG-RST](#) described in the Protocol Specification.

Acquisition and Aiding

Acquisition and Aiding strategies (Coldstart, Warmstart, Hotstart) and aiding functionalities (AGPS) are described below in the section [Aiding and Acquisition](#). These functions can be used and configured using the messages of the class [AID](#) described in the Protocol Specification.

Serial Communication Ports Description

u-blox 5 positioning technology comes with a highly flexible communication interface. It supports both the NMEA and the proprietary UBX protocol. It is truly multi-port and multi-protocol capable. Each protocol (UBX, NMEA) can be assigned to several ports at the same time (multi-port capability) with individual settings (e.g. baud rate, messages enabled, etc.) for each port. It is even possible to assign more than one protocol (e.g. UBX protocol and NMEA at the same time) to a single port (multi-protocol capability), which is particularly useful for debugging purposes.

The UBX and/or NMEA protocol must be activated to get a message on a port using the UBX proprietary message [UBX-CFG-PRT](#), which also allows to change port-specific settings (baud rate, address etc.). See [CFG-MSG](#) for a description of the mechanism of enabling and disabling messages.

UART Ports

One or two universal asynchronous receiver/transmitter ([UART](#)) ports are featured, that can be used to transmit GPS measurements, monitor status information and configure the receiver. See our online product selector [matrix](#) for availability.

The serial ports consist of an RX and a TX line. Neither handshaking signals nor hardware flow control signals are available. These serial ports operate in asynchronous mode. The baud rates can be configured individually for each serial port. However, there is no support for setting different baud rates for reception and transmission or for different protocols on the same port.

Possible UART Interface Configurations

Baud Rate	Data Bits	Parity	Stop Bits
4800	8	none	1
9600	8	none	1
19200	8	none	1
38400	8	none	1
57600	8	none	1
115200	8	none	1



If too much data is being configured for a certain port's bandwidth (e.g. all UBX messages shall be output on a UART port with a baud rate of 9600), the buffer will fill up. Once the buffer's space is exceeded, the receiver will deactivate messages automatically.



In order to ensure data validity a communication timeout of 2 sec is implemented for all communication interfaces (SPI, DDC, USB, UART). If for any reason transmission is not complete within this time the data is discarded. In case of UART this might lead to loss of messages if the number of bytes to transmit and the chosen baud rate are such that the transmission cannot complete within the timeout period. This applies to FW 6 and earlier revisions.

This potentially leads to loss of messages simply because there was not enough time to transmit them all. A workaround is to increase the baud rate or decrease the number of messages with the goal of completing the transmission within ~1sec (conservative approach).

Please note that for protocols such as NMEA or UBX, it does not make sense to change the default values of word length (data bits) since these properties are defined by the protocol, not by the electrical interface.

See [CFG-PRT for UART](#) for a description on the contents of the UART port configuration message.

USB Port

One USB ([Universal Serial Bus](#)) port is featured. See our online product selector [matrix](#) for availability. This port can be used for communication purposes and to power the GPS receiver.

The USB interface supports two different power modes:

- In the *Self Powered Mode* the receiver is powered by its own power supply. **VDDUSB** is used to detect the availability of the USB port, i.e. whether the receiver is connected to a USB host.
- In the *Bus Powered Mode* the device is powered by the USB bus, therefore no additional power supply is needed. The default maximum current that can be drawn by the receiver is 120mA in that mode. See [CFG-USB](#) for a description on how to change this maximum. Configuring the Bus Powered Mode implies that the device enters a low power state with disabled GPS functionality when the host suspends the device, e.g. when the host is put into stand-by mode.



*The voltage range for **VDDUSB** is specified from 3.0V to 3.6V, which differs slightly from the specification for VCC*

DDC Port

A DDC Bus ([Display Data Channel](#)) is implemented, which is a 2-wire communication interface compatible with the I2C standard ([Inter-Integrated Circuit](#)). See our online product selector [matrix](#) for availability.

In contrast to all other interfaces, the DDC is not able to communicate in full-duplex mode, i.e. TX and RX are mutually exclusive. u-blox 5 acts as a slave in the communication setup, therefore it cannot initiate data transfers on its own. The master provides the data clock, therefore master and slave don't need to be configured to use the same baud rate. Moreover, a baud rate setting is not applicable for the slave.



The baud rate clock provided by the master must not exceed 100kHz

The receiver's DDC address is set to 0x42 by default. This address can be changed by setting the `mode` field in [CFG-PRT for DDC](#) accordingly.

As the receiver will be run in slave mode and the physical layer lacks a handshake mechanism to inform the master about data availability, a layer has been inserted between the physical layer and the UBX and NMEA layer. The DDC implements a simple streaming interface that allows the constant polling of data, discarding everything that is not parseable. This means that the receiver returns 0xFF if no data is available.

If no data is polled for an extended period, the receiver temporarily stops writing data to the output buffer to prevent overflowing.

Read Access

To allow both polled access to the full message stream and quick access to the key data, the register layout depicted in Figure *DDC Register Layout* is provided. The data registers 0 to 252, at addresses 0x00 to 0xFC, each 1 byte in size, contain information to be defined at a later point in time. At addresses 0xFD and 0xFE, the currently available number of bytes in the message stream can be read. At address 0xFF, the message stream is located. Subsequent reads from 0xFF return the messages in the transmit buffer, byte by byte. If the number of bytes read exceeds the number of bytes indicated, the payload is padded using the value 0xFF.



The registers 0x00 to 0xFC will be defined in a later firmware release. Do not use them, as they don't provide any meaningful data!

DDC Register Layout

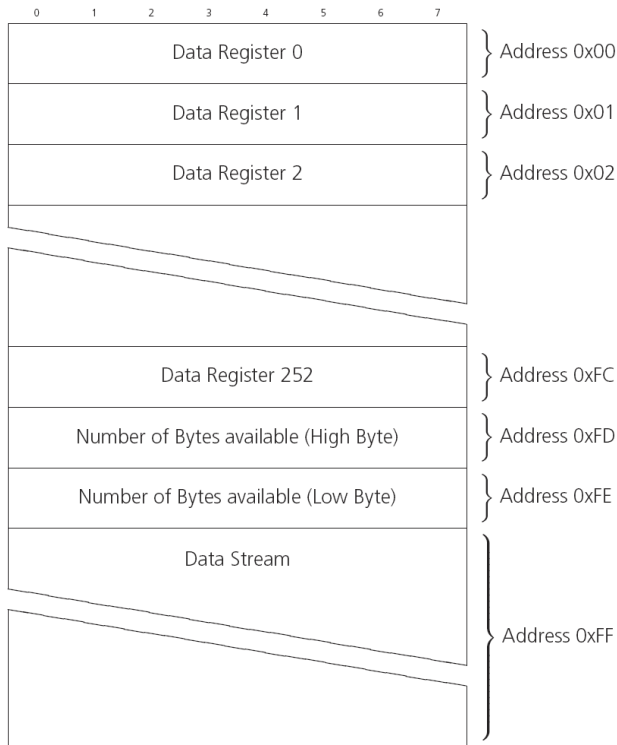

Random Read Access

Random read operations allow the master to access any register in a random manner. To perform this type of read operation, first the register address to read from must be written to the receiver (see Figure *DDC Random Read Access*). Following the start condition from the master, the 7-bit device address and the \overline{RW} bit (which is a logic low for write access) are clocked onto the bus by the master transmitter. The receiver answers with an acknowledge (logic low) to indicate that it is responsible for the given address. Next, the 8-bit address of the register to be read must be written to the bus. Following the receiver's acknowledge, the master again triggers a start condition and writes the device address, but this time the \overline{RW} bit is a logic high to initiate the read access. Now, the master can read 1 to N bytes from the receiver, generating a not-acknowledge and a stop condition after the last byte being read. After every byte being read, the internal address counter is incremented by one, saturating at 0xFF. This saturation means, that, after having read all registers coming after the initially set register address, the raw message stream can be read.

DDC Random Read Access

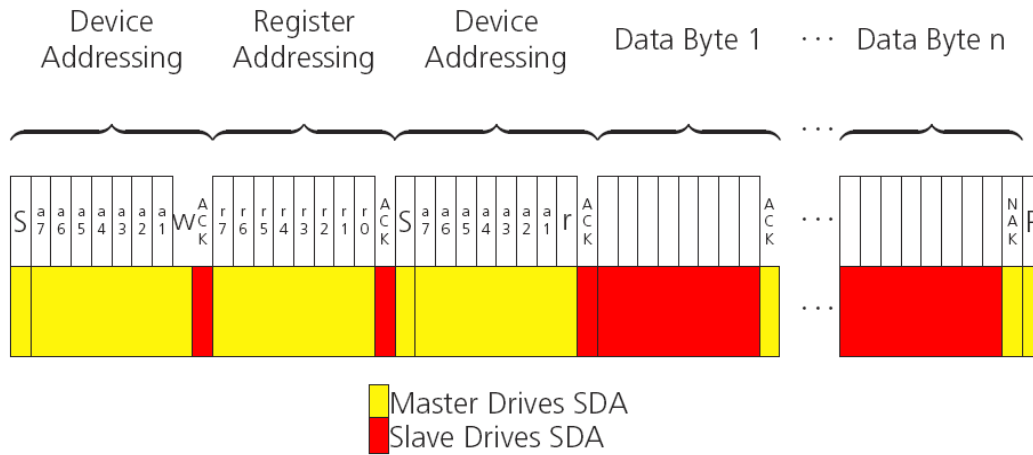

Current Address Read

The receiver contains an address counter that maintains the address of the last register accessed, internally incremented by one. Therefore, if the previous read access was to address n (n is any legal address), the next current address read operation would access data from address $n+1$ (see Figure *DDC Current Address Read Access*). Upon receipt of the device address with the RW bit set to one, the receiver issues an acknowledge and the master can read 1 to N bytes from the receiver, generating a not-acknowledge and a stop condition after the last byte being read.

To allow direct access to streaming data, the internal address counter is initialized to 0xFF, meaning that current address reads without a preceding random read access return the raw message stream. The address counter can be set to another address at any point in time using a random read access.

DDC Current Address Read Access

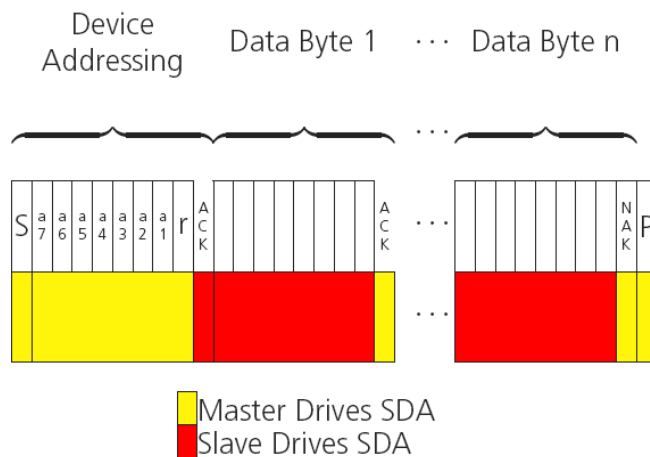

Write Access

The receiver does not provide any write access except for writing UBX messages (and NMEA messages) to the receiver, such as configuration or aiding data. Therefore, the register set mentioned in section [Read Access](#) is not writable. Following the start condition from the master, the 7-bit device address and the RW bit (which is a

logic low for write access) are clocked onto the bus by the master transmitter. The receiver answers with an acknowledge (logic low) to indicate that it is responsible for the given address. Now, the master can write 2 to N bytes to the receiver, generating stop condition after the last byte being written. The number of data bytes must be at least 2 to properly distinguish from the write access to set the address counter in random read accesses.

DDC Write Access

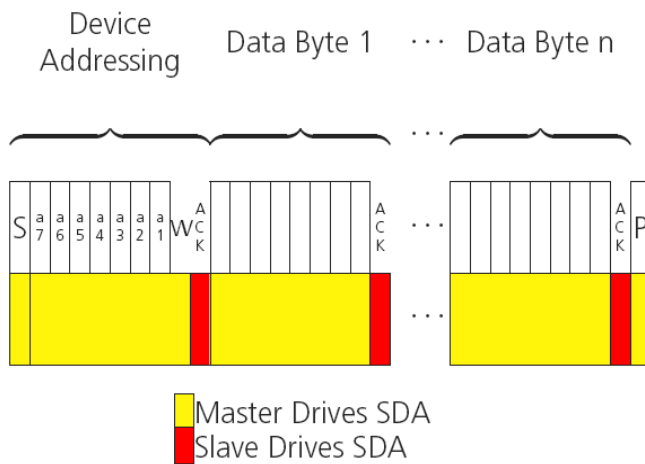

SPI Port

An SPI bus ([Serial Peripheral Interface Bus](#)) is available with selected receivers. See our online product selector [matrix](#) for availability. The SPI is a four-wire synchronous communication interface; In contrast to UART the master provides a clock, meaning that master and slave don't need to be configured to use the same baud rate. Moreover, a baud rate setting is not applicable for the slave. SPI modes 0-3 are implemented and can be configured using the field `mode spiMode` in [CFG-PRT for SPI](#) (default is SPI mode 0).



The baud rate clock provided by the master must not exceed 25kHz

Read Access

As the register mode is not implemented for the SPI port, only the UBX/NMEA message stream is provided. This stream is accessed using the Back-To-Back Read and Write Access (see section [Back-To-Back Read and Write Access](#)). When no data is available to be written to the receiver, `MOSI` should be held logic high, i.e. all bytes written to the receiver are set to 0xFF.

In order to prevent the receiver from being busy parsing the incoming data, the parsing process is stopped after 50 subsequent bytes containing 0xFF. The parsing process gets re-enabled with the first byte not equal to 0xFF. The number of bytes to wait for deactivation (50 by default) can be adjusted using the field `ffCnt` in [CFG-PRT for SPI](#).

If the receiver has no more data to send, it pulls `MISO` to logic high, i.e. all bytes transmitted are set to 0xFF. This means that the master should ignore all 0xFF which are not part of a message. It can resume data processing as soon as the first byte not equalling 0xFF is received.

Back-To-Back Read and Write Access

The receiver does not provide any write access except for writing UBX messages (and eventually NMEA messages) to the receiver, such as configuration or aiding data. For every byte written to the receiver, a byte must be read from the receiver; the master writes to MOSI and, at the same time, it reads from MISO. The data on MISO represents the results from a current address read, returning 0xFF when no more data is available.

SPI Back-To-Back Read/Write Access

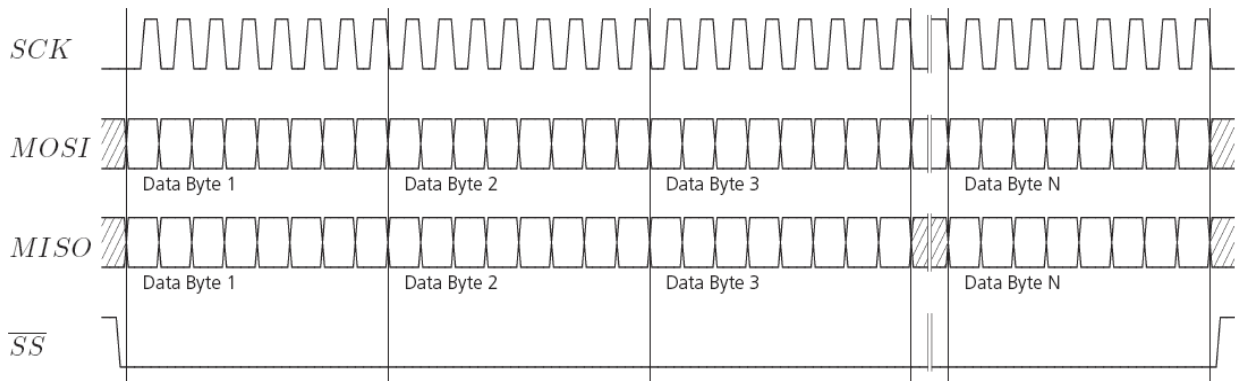

How to change between protocols

Reconfiguring a port from one protocol to another is a two-step process:

- First of all, the preferred protocol(s) needs to be enabled to a port using [CFG-PRT](#). One port can handle several protocols at the same time (e.g. NMEA and UBX). By default, all ports are configured for UBX and NMEA protocol so in most cases, it's not necessary to change the port settings at all. Port settings can be viewed and changed using the [CFG-PRT](#) messages.
- As a second step, activate certain messages on each port using [CFG-MSG](#).



Despite the fact that concatenation of several configurations is still possible on receivers before u-blox 5, the use of this feature is discouraged as it won't work on u-blox 5. u-blox 5 has 6 I/O ports, so backwards compatibility is dropped at this point.

Forcing a Receiver Reset

Typically, in GPS receivers, one distinguishes between Cold-, Warm- and Hotstarts, depending on the type of valid information the receiver has at the time of the restart.

- **Coldstart** In this startup mode, the receiver has **no** a-priori information on last position, time, velocity, frequency etc. Therefore, the receiver has to search the full time- and frequency space, and also all possible satellite numbers. If a satellite signal is found, it is being tracked to decode ephemeris (18-36 seconds under strong signal conditions), whereas the other channels continue to search satellites. Once there are sufficient number of satellites with valid ephemeris, the receiver can calculate position- and velocity data. Please note that some competitors call this startup mode `Factory Startup`.
- **Warmstart** In warmstart mode, the receiver has approximate information of time, position, and coarse data on Satellite positions (Almanac). In this mode, after power-up, the receiver basically needs to download

ephemeris until it can calculate position- and velocity data. As the ephemeris data usually is outdated after 4 hours, the receiver will typically start with a warmstart if it has been powered down for more than 4 hours. For this scenario, several augmentations exist. See the section on [Aiding and Acquisition](#).

- **Hotstart** In Hotstart, the receiver was powered down only for a short time (4 hours or less), so that its ephemeris is still valid. Since the receiver doesn't need to download ephemeris again, this is the fastest startup method.

In the [UBX-CFG-RST](#) message, one can force the receiver to reset and clear data, in order to see the effects of maintaining/losing such a-priori data between restarts. For that, the CFG-RST message offers the `navBbrMask` field, where Hot-, Warm- and Coldstarts can be initiated, and also other combinations thereof.

The Reset Type can also be specified. This is not GPS-related, but the way the software restarts the system.

- **Hardware Reset** uses the on-chip Watchdog, in order to electrically reset the chip. This is an immediate, asynchronous reset. No Stop events are generated. This is equivalent to pulling the Reset signal on the receiver.
- **Controlled Software Reset** terminates all running processes in an orderly manner and, once the system is idle, restarts operation, reloads its configuration and starts to acquire and track GPS satellites
- **Controlled Software Reset (GPS only)** only restarts the GPS tasks, without reinitializing the full system or reloading any stored configuration.
- **Controlled GPS Stop** stops all GPS tasks. The receiver will not be restarted, but will stop any GPS related processing.
- **Controlled GPS Start** starts all GPS tasks.

Timepulse Configuration

The receiver provides a hardware-synchronized timepulse pin with a time pulse (TP) period of >1 ms to 4s (0.25...999 Hz). The polarity (rising or falling edge) and the pulse duration can be configured. Use the UBX proprietary message [CFG-TP](#) to change the timepulse settings. The [UBX-TIM-TP](#) message provides the time information for the next timepulse, time source and a quantization error.

The [CFG-TP](#) message comprises the following parameters defining the hardware-synchronized timepulse:

- **pulse interval** - time interval between timepulses
- **pulse length** - duration of the timepulse (time period between rising and falling edge)
- **pulse mode** - if not disabled the synchronization of timepulse can be configured to be done on rising or falling edge
- **time reference** - the reference time source (time base) used for timepulse synchronization and timepulse time given in [TIM-TP](#) output message
- **synchronization mode** - the timepulse can be configured to be always synchronized and will be available only in this case. If the timepulse is allowed to be asynchronized it will be available at any time even when the time is not valid.
- **antenna cable delay** - the signal delay due to the cable between antenna and receiver
- **RF group delay** - delay of the signal in the RF module of the u-blox 5 receiver (hard coded)
- **user delay** - the cable delay from u-blox 5 receiver to the user device plus signal delay of any user application

Pulse Mode: Rising

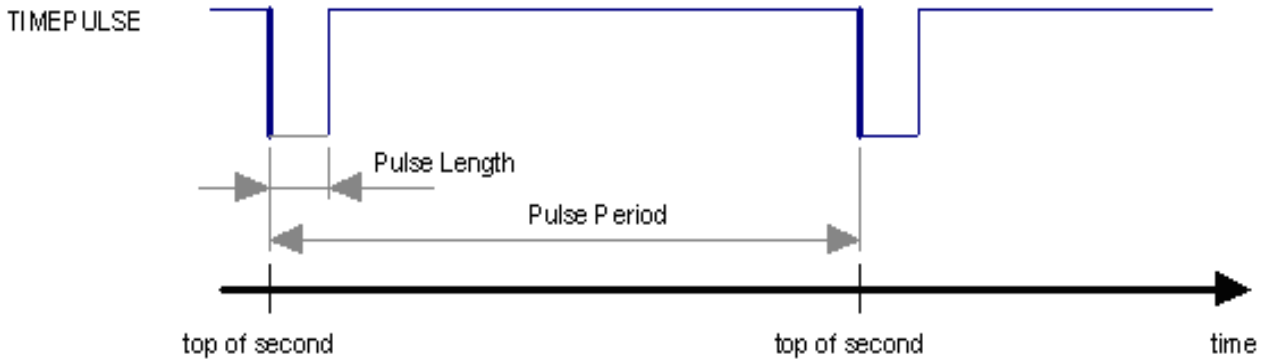
Pulse Mode: Falling

Notes:

- The pulse interval must be an integer division of 60 seconds.
- The maximum pulse length can't exceed the pulse period minus 1 microsecond.
- A timepulse is only output when the receiver has determined the time with sufficient accuracy and reliability.

Recommendations for timing applications [LEA-5T]:

- When using the timepulse for a timing application it is recommended to calibrate the RF signal delay against a reference-timing source.
- Care needs to be given to the Cable Delay settings in the receiver configuration.
- In order to get the best timing accuracy with the antenna, a fixed *accurate* position is needed. Once the receiver is in timing mode, the dynamic model does not influence the timing accuracy.
- If relative time accuracy between multiple receivers is required, do not mix receivers from different product families, brands or ROM/FW version. Otherwise set cable delays on one of the two receivers such that the timepulses are not biased.

Example:

The example shows the 1PPS timepulse signal generated according the specific parameters of the [CFG-TP](#) message.

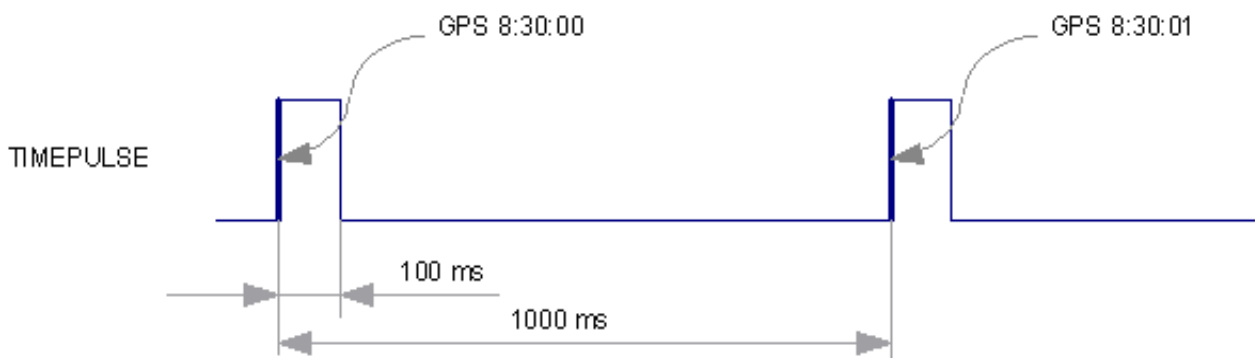

UBX - CFG (Config) - TP (Time Pulse)

Pulse Mode: +1 - rising edge

Pulse Period: 1000.000 [ms]

Pulse Length: 100.000 [ms]

Pulse Frequency: 1.00000 [Hz]

Time Source: 1 - GPS time

Cable Delay: 50 [ns]

User Delay: 0 [ns]

RF Group Delay: 0 [ns]

allow async

The sequential order of the signal present at pin timepulse and the respective output message for the simple case of 1 pulse per second and a one second navigation update rate is shown in the following figure.

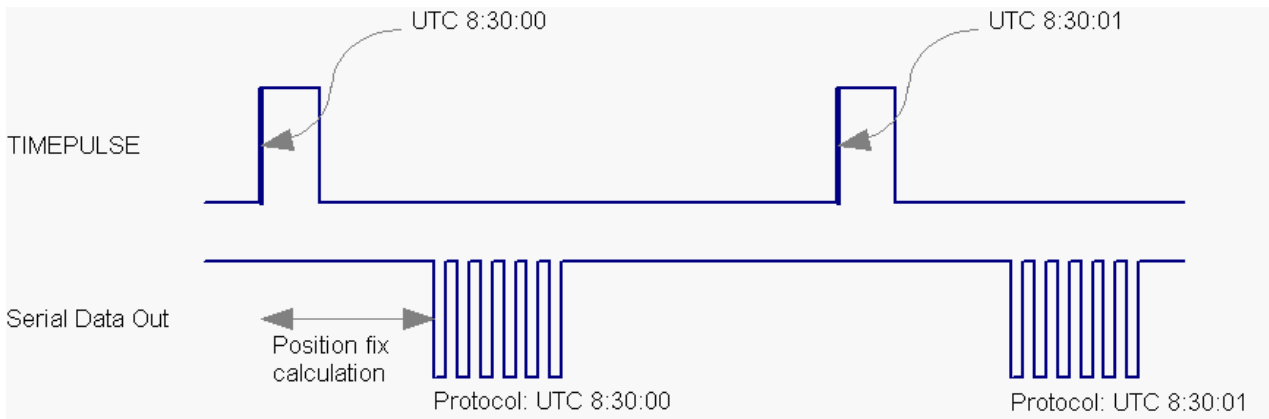

Receiver Configuration

Configuration Concept

u-blox positioning technology is fully configurable with UBX protocol configuration messages (message class UBX-CFG). The configuration used by the GPS receiver during normal operation is termed "Current Configuration". The Current Configuration can be changed during normal operation by sending any UBX-CFG-XXX message to the receiver over an I/O port. The receiver will change its Current Configuration immediately after receiving the configuration message. The GPS receiver always uses only the Current Configuration.

Unless the Current Configuration is made permanent by using [CFG-CFG](#) as described below, the Current Configuration will be lost in case of (see message [CFG-RST](#))

- a power cycle
- a hardware reset
- a (complete) controlled software reset

The Current Configuration can be made permanent (stored in a non-volatile memory) by saving it to the "Permanent Configuration". This is done by sending a [UBX-CFG-CFG](#) message with an appropriate **saveMask** (UBX-CFG-CFG/save).

The Permanent Configurations are copied to the Current Configuration after start-up or when a [UBX-CFG-CFG](#) message with an appropriate **loadMask** (UBX-CFG-CFG/load) is sent to the receiver.

The Permanent Configuration can be restored to the receiver's Default Configuration by sending a [UBX-CFG-CFG](#) message with an appropriate **clearMask** (UBX-CFG-CFG/clear) to the receiver.

This only replaces the Permanent Configuration, not the Current Configuration. To make the receiver operate with the Default Configuration which was restored to the Permanent Configuration, a UBX-CFG-CFG/load command must be sent or the receiver must be reset.

The mentioned masks (saveMask, loadMask, clearMask) are 4 byte bit fields. Every bit represents one configuration sub-section. These sub-sections are defined in section "[Organization of the Configuration Sections](#)". All three masks are part of every UBX-CFG-CFG message. Save, load and clear commands can be combined in the same message. Order of execution is clear, save, load.

The following diagram illustrates the process:

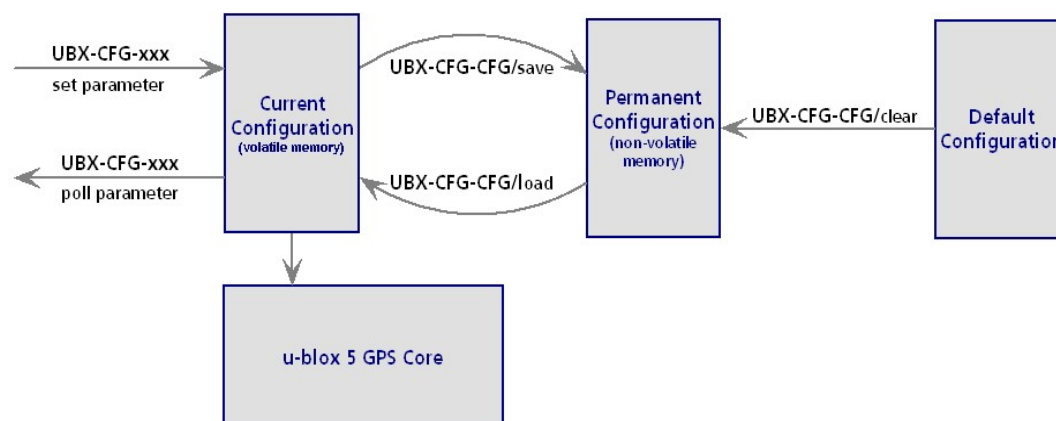

Organization of the Configuration Sections

The configuration is divided into several sub-sections. Each of these sub-sections corresponds to one or several UBX-CFG-XXX messages. The sub-section numbers in the following tables correspond to the bit position in the masks mentioned above.

Configuration sub-sections on Antaris

<i>sub-section</i>	<i>CFG messages</i>	<i>Description</i>
0	UBX-CFG-PRT UBX-CFG-USB	Port and USB settings
1	UBX-CFG-MSG	Message settings (enable/disable, update rate)
2	UBX-CFG-INF	Information output settings (Errors, Warnings, Notice, Test etc.)
3	UBX-CFG-NAV5 UBX-CFG-DAT UBX-CFG-RATE UBX-CFG-SBAS UBX-CFG-NMEA UBX-CFG-TMODE	Navigation Parameter, Receiver Datum, Measurement and Navigation Rate setting, Timemode settings, SBAS settings, NMEA protocol settings
4	UBX-CFG-TP	Timepulse Settings
5	N/A	Reserved for future low power modes
6-9	N/A	Reserved for EKF (Dead Reckoning) Receivers
10	UBX-CFG-ANT	Antenna configuration
11-31	N/A	Reserved

Configuration sub-sections on u-blox 5 and u-blox 6

<i>sub-section</i>	<i>CFG messages</i>	<i>Description</i>
0	UBX-CFG-PRT UBX-CFG-USB	Port and USB settings
1	UBX-CFG-MSG	Message settings (enable/disable, update rate)
2	UBX-CFG-INF	Information output settings (Errors, Warnings, Notice, Test etc.)
3	UBX-CFG-NAV5 UBX-CFG-DAT UBX-CFG-RATE UBX-CFG-SBAS UBX-CFG-NMEA UBX-CFG-TMODE	Navigation Parameter, Receiver Datum, Measurement and Navigation Rate setting, Timemode settings, SBAS settings, NMEA protocol settings
4	UBX-CFG-TP	Timepulse Settings
5-7	N/A	Reserved
8	N/A	Reserved for future SFDR configuration
9	UBX-CFG-RINV	Remote Inventory configuration
10	UBX-CFG-ANT	Antenna configuration
11-31	N/A	Reserved

Permanent Configuration Storage Media

The Current Configuration is stored in the receiver's volatile RAM. Hence, any changes made to the Current Configuration without saving will be lost in the events listed in the section above. By using UBX-CFG-CFG/save, the selected configuration sub-sections are saved to all non-volatile memories available:

- On-chip BBR (battery backed RAM). In order for the BBR to work, a backup battery must be applied to the receiver.
- External FLASH memory, where available.
- External EEPROM (Electrically Erasable Programmable Read-Only Memory), where available via DDC (I2C compatible).
- External serial FLASH memory, where available via SPI.

Receiver Default Configuration

Permanent Configurations can be reset to Default Configurations through a UBX-CFG-CFG/clear message. The receiver's Default Configuration is determined at system startup. The Default Configuration depends on various information such as system clock frequency and others. The receiver searches for this information in various places (memories and configuration pins). Refer to the receiver's data sheet for details.

Power Management

u-blox 5 receivers support different power modes. These modes represent different strategies with which the receiver controls acquisition and tracking engines in order to achieve either the best possible performance or good performance with reduced power consumption.

A power mode is selected using the configuration message [CFG-RXM](#).

Maximum Performance Mode

During a cold start, a receiver in Maximum Performance Mode deploys the acquisition engine continuously to search for all satellites. Once a position fix is determined (or if pre-positioning information is available) the acquisition engine is used to search for all satellites from the list of visible SVs, that are not being tracked.

Eco Mode

During a cold start, a receiver in Eco Mode functions exactly as in Maximum Performance Mode. Once a position fix can be calculated and a sufficient number of satellites are tracked, the acquisition engine is powered off resulting in significant power savings. In this mode, the tracking engine continuously tracks acquired satellites and acquires other available or emerging satellites.

Note that even if the acquisition engine is powered off, satellites continue to be acquired and tracked.

Power Save Mode

Power Save Mode (PSM) allows a reduction in system power consumption by periodically switching the receiver on and off. PSM uses 4 different operation states: ON-state, OFF-state, Start-up state, and Power Optimized Tracking (POT) state.

- ON-state: Receiver continuously tracking and downloading data. Less power consumption than in start-up state.
- OFF-state: Receiver internally switched off. Back-up battery required.
- start-up: Receiver actively searching and acquiring signals. Maximum power consumption.

- POT-state: Receiver tracks signals but doesn't search for new signals and doesn't download data. C/NO must be above 30 dBHz.

A number of parameters can be configured to customize PSM to your specific needs. These parameters are listed in the following table:

Power Save Mode configuration options

Parameter	Description
Update Period	Time between two position fix attempts
Search Period	Time between two acquisition attempts if the receiver is unable to get a position fix
Grid Offset	Time offset of update grid with respect to GPS start of week
On Time	Time the receiver remains on after the first fix
Acq. Timeout	Minimum time after which the receiver stops acquisition and returns to OFF-state
WaitTimeFix	Wait for time fix before entering ON-state
Update RTC	Enables periodic Real Time Clock (RTC) update
Update Ephemeris	Enables periodic Ephemeris update
EXTINT Selection	Selects EXTINT pin used with pin control feature
EXTINT Forces ON	Enables force-ON pin control feature
EXTINT Forces OFF	Enables force-OFF pin control feature

Configuring Power Save Mode

Power Save Mode is configured using the [UBX-CFG-PM](#) message. Power Save Mode is enabled and disabled by the Power Mode field of the [UBX-CFG-RXM](#) message.

When PSM is enabled, communication with the receiver (e.g. disabling PSM) requires particular attention. This is because the receiver may be in Backup State and therefore unable to receive any message through its interfaces. To ensure that the configuration messages arrive at the receiver, even during Backup State when the configuration is saved to non-volatile memory, the following steps need to be taken:

- Send a dummy sequence of 0xFF (1 byte is sufficient) to the receiver. This wakes up the receiver in case it is in Backup State. If the receiver is already on, the sequence will be ignored.
- Send the configuration message immediately after the dummy sequence. The interval between messages must be less than 200ms, or the receiver will return to Backup State.
- Send the configuration save message immediately after the configuration message. The interval between messages must be less than 200ms, or the receiver will return to Backup State and the changes will be lost.



When enabling Power Management SBAS support can be disabled ([UBX-CFG-SBAS](#)) since the receiver will be unable to download any SBAS data in Power Save Mode.

Update-, search period & grid offset

The update period specifies the time between position fixes. If a position cannot be obtained within the acquisition timeout, the receiver will re-try to search, with the time between retrials specified in the search period.

The update grid is aligned to the start of the week (sat/sun 00:00), once the receiver has a valid time. Before this the grids are unaligned. The search period starts at the start-up time of the last unsuccessful start-up. Grid offset moves the starting points of the update grid.

Long update periods

When the receiver is switched on, it first enters start-up state. If it is able to obtain a position fix within the time given by acquisition timeout, it switches to ON-state; if not, it will enter OFF-state and re-start in start-up state on the next search grid time. ON-Time starts with the first fix which is not masked (the masks can be set using CFG-NAV). Once ON-Time is over, OFF-state is entered and the receiver re-starts on the next update grid time. If the signal is lost during the ON-Time, start-up state is entered. If the signal is not found within the acquisition time-out, the receiver enters OFF-state. Otherwise the receiver will re-enter ON-state and stay there until the newly started ON-Time is over.

Short updates periods

When the receiver is switched on it first enters start-up state. If it is able to obtain a position fix within the time given by the acquisition timeout it switches to ON-state. If the receiver is unable to obtain a position the receiver will enter OFF-state and re-start in start-up state on the next search grid time. ON-Time starts with the first fix which is not masked (the masks can be set with CFG-NAVX5). Once the ON-Time is over, POT-state is entered. In POT-state the receiver continues to output position fixes according to the update period. To have maximum power savings, set ON-Time to zero. This causes the receiver to enter POT-state immediately after start-up. If the signal is lost during POT state, start-up state is entered. If the start-up fails, OFF-state is entered.

Infinite periods

Setting the update period to zero causes the receiver to wait in OFF-state until an external position request is sent.

Setting the search period to zero causes the receiver to wait in OFF-state indefinitely after an unsuccessful start-up. Any wake-up event can still wake up the receiver.

Acquisition timeout & ON-Time

The receiver tries to obtain a position fix within the time given in acquisition time-out. This setting is treated as a minimum value. If the receiver determines that it needs more time for the given starting conditions, it will automatically prolong this time. If set to zero, the acquisition timeout is determined fully by the receiver. ON-Time specifies how long the receiver produces position fixes. The quality of the fixes can be set by setting the masks in CFG-NAV. The 'wait for time fix' option tells the receiver to start the ON-Time once valid time fixes and time-pulse are available. This usually takes a few seconds longer than position fixes. Keep in mind that setting harder limits in CFG-NAVX5 will prolong start-up time. So you might want to increase the acquisition timeout.

Maintain fast start-up

In order to achieve a fast start-up the receiver needs to calibrate its RTC regularly and update its Ephemeris data. This can be done by activating the Update RTC and Eph option. The RTC is calibrated about every 5 minutes, and the Ephemeris data is updated approximately every 30 minutes.

Communication & wake-up

In start-up, ON- and POT-state the receiver is fully running and communication is always possible. Before communication can start in OFF-state, the receiver needs a wake-up signal. Any signal activity (edges) on the EXTINT or UART RX lines is interpreted by the receiver as a wake-up condition. All wake-up signals are interpreted as a position request, where the receiver wakes up and tries to obtain a position fix. Wake-up signals have no effect if the receiver is already ON or in POT-state.

After wake-up the communication system takes 100-300 ms to start up. If the RXM-RXR message is enabled, it is sent as soon as the receiver is ready to receive data on the UART. Before entering OFF-state again the same message signals the end of communication readiness. A system RESET is a user wake-up event too and will lead to the same behavior as an edge on the EXTINT or UART lines.

Pin Control

The pin control feature allows the user to override the automatic ON/OFF cycling of the Power Save mode. The ON/OFF state of the receiver can be controlled through either one of the EXTINT0 or EXTINT1 pins.

If the Force-ON feature is enabled the receiver will not switch OFF as long as the selected EXTINT pins are at a 'high' level. When the pin level changes to 'low' the receiver will continue with its configured power management behavior. UBX-CFG-PM is used to select / configure the pin (EXTINT0 or EXTINT1) that will control the PM behavior as described above.

If the Force-OFF feature is enabled the receiver will switch itself OFF (with a delay of up to 5 seconds) and stay OFF until awoken by a Wake-Up Event. The receiver can be awoken by a wake-up event even though configuration pins command the OFF mode. The result however, is that the receiver only wakes up for a period of time long enough to read the pin configuration and to switch back to the OFF mode.

FixNow Interface

The CFG-FXN message is still accepted, *but may be discontinued in future versions of the software.*



Do not use UBX-CFG-FXN for new designs.

The parameters are mapped as follows: update period = $t_{on} + t_{off}$; on-time = t_{on} ; search period = $t_{acq} + t_{acq_off}$; minAcqTime = t_{acq} ; grid offset = base TOW. Aligned is always enabled. System mode is always set to backup. If on/off is not selected update period is set to 1s, which causes the receiver to track in POT. All updates, waitTimeFix and peak current reduction are disabled. Wakeup on EXTINT0.

Since u-blox 5 Power Management has different configuration parameters than FixNow the UBX-CFG-FXN message parameters have to be mapped to UBX-CFG-PM message parameters.

FXN to PM parameter mapping with "FXN On/Off Time" enabled

Power Management parameter	FixNow parameter(s)	Default Value
Update Period	$T_{on} + T_{off}$	-
ON-Time	T_{on}	-
Search Period	$T_{acq} + T_{acq_off}$	-
Min acq.time	T_{acq}	-
Grid Offset	Base TOW	-
Wait for Timefix	-	Disabled
Update RTC	-	Disabled
Update Ephemeris	-	Disabled

FXN to PM parameter mapping with "FXN On/Off Time" enabled continued

Power Management parameter	FixNow parameter(s)	Default Value
EXTINT Selection	-	EXTINT0
EXTINT Forces ON	-	Disabled
EXTINT Forces OFF	-	Disabled
Limit Peak Current	-	Enabled

FXN to PM parameter mapping with "FXN On/Off Time" disabled

Power Management parameter	FixNow parameter(s)	Default Value
Update Period	-	1000 [ms]
ON-Time	T_on	-
Search Period	T_acq + T_acq_off	-
Min acq.time	T_acq	-
Grid Offset	-	0
Wait for Timefix	-	Disabled
Update RTC	-	Disabled
Update Ephemeris	-	Disabled
EXTINT Selection	-	EXTINT0
EXTINT Forces ON	-	Disabled
EXTINT Forces OFF	-	Disabled
Limit Peak Current	-	Enabled

Default settings

PSM configuration defaults

Configuration parameter	Default Value
Update Period	1000 [ms]
ON-Time	2 [s]
Search Period	10'000 [ms]
Min Acq. Time	0 [s]
Grid Offset	0 [ms]
Wait for Timefix	Disabled
Update RTC	Disabled
Update Ephemeris	Enabled
EXTINT Selection	EXTINT0
EXTINT Forces ON	Disabled
EXTINT Forces OFF	Disabled
Limit Peak Current	Disabled

NOTE: Although some settings have the unit milliseconds, all settings are restricted to whole seconds.

Operation

Depending on the configuration of the Update Period the receiver will show slightly different behavior. When configured for short update periods (i.e. ≤ 5 s) the receiver does not shut down completely between fixes, but instead uses power optimized tracking. For long update periods or when the receiver doesn't receive any signals, it either runs in full operation or in backup state.

The receiver tries to get position fixes in the configured update grid regardless of the possible increase in

current consumption and will stick to the configured search grid to reacquire the signal in case it was lost. The following figures illustrate receiver behavior for short update periods on the left and for long update periods on the right.

State Diagram

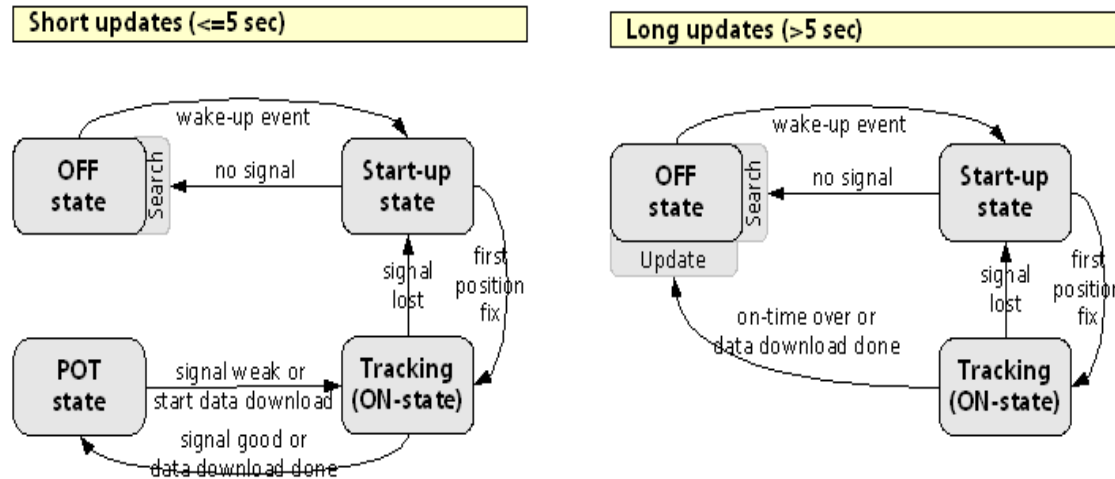

Power Optimized tracking is only possible down to a minimal C/N0 of approximately 30dBHz. To maintain position fixes the receiver switches from power optimised tracking to normal tracking when less than 5 SVs are reliably tracked. If getting a position fix fails in normal tracking the receivers tries to reacquire the signal in the configured search grid starting with one immediate search.

When configured for long update periods the receiver repeatedly performs hot or warm starts in the configured update grid. If start-up fails (i.e. there is no position fix obtained before a timeout) the receiver attempts a start-up in the search grid. If successful it then returns to the update grid.

Satellite Data Download

The receiver is not able to download satellite data (e.g. the Ephemeris) while it is in an intermittent operation mode. Therefore it has to temporarily switch to continuous operation for the time the satellites transmit the desired data.

To save power the receiver schedules the download time-windows according to an internal timetable which is based on the GPS ICD and only switches to continuous operation mode while data of interest is transmitted by the SVs.

Each SV transmits its own Ephemeris data. The download of Ephemeris data is feasible when the corresponding SV has been tracked with a minimal C/N0 (currently set to 33dBHz) over a certain time period. The download is scheduled in a 30 minute grid or immediately when less than a certain number (currently 7 SVs) of visible SVs have valid Ephemeris.

Almanac, ionosphere- and UTC correction, and SV health data are transmitted by all SVs simultaneously. Therefore these parameters can be downloaded when a single SV is tracked with a high enough C/N0.

Expected GPS Performance

Power Save Mode is specifically designed to have no negative impact on GPS performance. However, under certain circumstances (especially when there are fast signal changes), the receiver might lose track and enter backup mode.

Peak Current Reduction

The peak current during acquisition can be reduced by activating the corresponding option in [CFG-PM](#). This will result in longer start-up times of the receiver. This setting is independent of the activated mode (Maximum Performance, Eco or Power Save Mode).

Power On/Off command

Using the power mode request [RXM-PMREQ](#) message the receiver can be commanded to backup mode. It will stay in backup mode for a predefined time specified in the message or until it is woken up by an EXTINT or activity on the RX1 line. Note that it is not necessary to send a [RXM-POSREQ](#) or [RXM-PMREQ](#) message. Do not use this message if Power Save Mode is active.

SBAS Configuration Settings Description

SBAS (Satellite Based Augmentation Systems)

SBAS (Satellite Based Augmentation System) is an augmentation technology for GPS, which calculates GPS integrity and correction data with RIMS (Ranging and Integrity Monitoring Stations) on the ground and uses geostationary satellites (GEOs) to broadcast GPS integrity and correction data to GPS users. The correction data is transmitted on the GPS L1 frequency (1575.42 MHz), and therefore no additional receiver is required to make use of the correction- and integrity data.

SBAS Principle

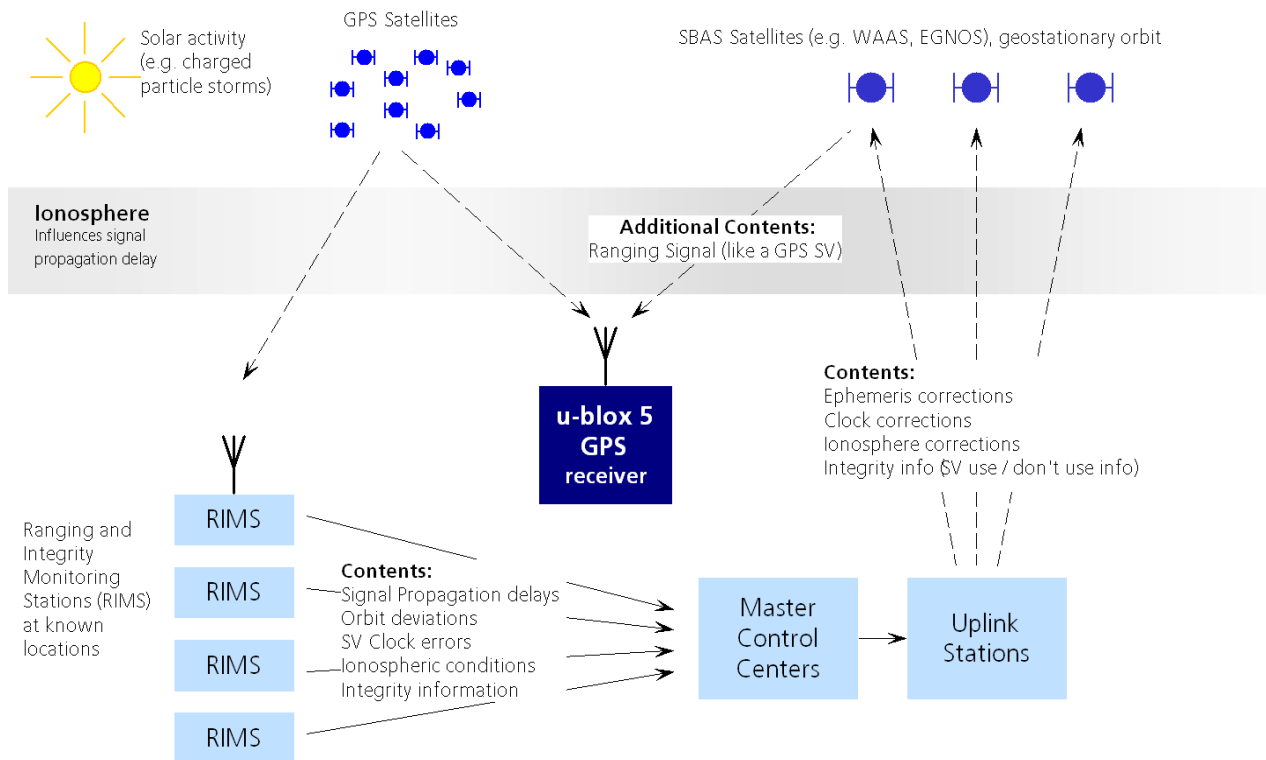

There are several compatible SBAS systems available or in development all around the world:

- WAAS (Wide Area Augmentation System) for North America has been in operation since 2003.
- MSAS (Multi-Functional Satellite Augmentation System) for Asia has been in operation since 2007.
- EGNOS (European Geostationary Navigation Overlay Service) is in test mode ESTB (EGNOS satellite test bed). Full operation of EGNOS is planned for 2010.
- GAGAN (GPS Aided Geo Augmented Navigation), developed by the Indian government is in test mode and expected to be operational by 2010.

SBAS support allows u-blox 5 technology to take full advantage of the augmentation systems that are currently available (WAAS, EGNOS, MSAS), as well as those being tested and planned (such as GAGAN).

With SBAS enabled the user benefits from additional satellites for ranging (navigation). u-blox 5 technology uses the available SBAS Satellites for navigation just like GPS satellites, if the SBAS satellites offer this service.

To improve position accuracy SBAS uses different types of correction data:

- **Fast Corrections** for short-term disturbances in GPS signals (due to clock problems, etc).
- **Long-term corrections** for GPS clock problems, broadcast orbit errors etc.
- **Ionosphere corrections** for Ionosphere activity

Another benefit is the use of GPS integrity information. In this way SBAS Control stations can 'disable' usage of GPS satellites in case of major GPS satellite problems within a 6 second alarm time. If integrity monitoring is enabled, u-blox 5 GPS technology will only use satellites, for which integrity information is available.

For more information on SBAS and associated services please refer to

- RTCA/DO-229C (MOPS). Available from www.rtca.org
- gps.faa.gov for information on WAAS and the NSTB
- www.esa.int for information on EGNOS and the ESTB
- www.essp.be for information about European Satellite Services Provider EEIG is the EGNOS operations

manager.

- www.kasc.go.jp for information on MSAS

GEO satellites used by WAAS, EGNOS and MSAS (as of February 2008)

GEO Identification	Position	GPS PRN	SBAS Provider
Intelsat Galaxy XV	133° W	135	WAAS
TeleSat Anik F1R	107.3° W	138	WAAS
Inmarsat 3F2 AOR-E	15.5° W	120	EGNOS
Artemis	21.5° W	124	EGNOS
Inmarsat 3F5 IOR-W	25° E	126	EGNOS
MTSAT-1R	140° E	129	MSAS
MTSAT-2	145° E	137	MSAS
Inmarsat 4F1 IOR	64° E	127	GAGAN

SBAS Features



This u-blox 5 SBAS implementation is, in accordance with standard RTCA/DO-229C, a class Beta-1 equipment. All timeouts etc. are chosen for the En Route Case. Do not use this equipment under any circumstances for safety of life applications!

u-blox 5 is capable of receiving multiple SBAS satellites in parallel, even from different SBAS systems (WAAS, EGNOS, MSAS, etc.). They can be tracked and used for navigation simultaneously. At least three SBAS satellites can be tracked in parallel. Every SBAS satellite tracked utilizes one vacant GPS receiver tracking channel. Only the number of receiver channels limits the total number of satellites used. Each SBAS satellite, which broadcasts ephemeris or almanac information, can be used for navigation, just like a normal GPS satellite.

For receiving correction data, the u-blox 5 GPS receiver automatically chooses the best SBAS satellite as its primary source. It will select only one since the information received from other SBAS GEOs is redundant and/or could be inconsistent. The selection strategy is determined by the proximity of the GEOs, the services offered by the GEO, the configuration of the receiver (Testmode allowed/disallowed, Integrity enabled/disabled) and the signal link quality to the GEO.

In case corrections are available from the chosen GEO and used in the navigation calculation, the DGPS flag is set in the receiver's output protocol messages (see [NAV-SOL](#), [NAV-STATUS](#), [NAV-SVINFO](#), [NMEA Position Fix Flags description](#)). The message [NAV-SBAS](#) provides detailed information about which corrections are available and applied.

The most important SBAS feature for accuracy improvement is Ionosphere correction. The measured data from RIMS stations of a region are combined to a TEC (Total Electron Content) Map. This map is transferred to the GPS devices via the GEOs to allow a correction of the ionosphere error on each received satellite.

Supported SBAS messages

Message Type	Message Content	Used from GEO
0(0/2)	Test Mode	All
1	PRN Mask Assignment	Primary
2, 3, 4, 5	Fast Corrections	Primary
6	Integrity	Primary
7	Fast Correction Degradation	Primary
9	GEO Navigation (Ephemeris)	All
10	Degradation	Primary
12	Time Offset	Primary
17	GEO Almanacs	All

Supported SBAS messages continued

Message Type	Message Content	Used from GEO
18	Ionosphere Grid Point Assignment	Primary
24	Mixed Fast / Long term Corrections	Primary
25	Long term Corrections	Primary
26	Ionosphere Delays	Primary

As each GEO services a specific region, the correction signal is only useful within that region. Therefore, mission planning is crucial to determine the best possible configuration. The different stages (Testmode vs. Operational) of the various SBAS systems further complicate this task. The following examples show possible scenarios:

Example 1: SBAS Receiver in North America

At the time of writing, the WAAS system is in operational stage, whereas the EGNOS system is still in test mode (ESTB). Therefore, and especially in the eastern parts of the US, care must be taken in order not to have EGNOS satellites taking preference over WAAS satellites. This can be achieved by disallowing Test Mode use (this inhibits EGNOS satellites from being used as a correction data source), but keeping the PRN Mask to have all SBAS GEOs enabled (which allows EGNOS GEOs to be used for navigation).

Example 2: SBAS Receiver in Europe

At the time of writing, the EGNOS system is still in test mode. To try out EGNOS operation, Testmode usage must be enabled. Since the [WAAS GEO #122](#) can be received in the western parts of Europe, but since this GEO does not carry correction data for the European continent, the GEOs from all but the EGNOS system should be disallowed, using the PRN Mask. It is important to understand that while EGNOS is in test mode, anything can happen to the EGNOS signals, such as sudden interruption of service or broadcast of invalid or inconsistent data.



The u-blox 5 GPS receiver always makes use of the best available SBAS correction data.

SBAS Configuration

To configure the SBAS functionalities use the UBX proprietary message [UBX-CFG-SBAS](#) ([SBAS Configuration](#)).

SBAS Configuration parameters

Parameter	Description
Mode - SBAS Subsystem	Enables or disables the SBAS subsystem
Mode - Allow test mode usage	Allow / Disallow SBAS usage from satellites in Test Mode (Message 0)
Services/Usage - Ranging	Use the SBAS satellites for navigation
Services/Usage - Apply SBAS correction data	Combined enable/disable switch for Fast-, Long-Term and Ionosphere Corrections
Services/Usage - Apply integrity information	Use integrity data
Number of tracking channels	Sets how many channels are reserved for SBAS tracking (if that many SBAS signals were acquired). E.g., if this is set to three and five SBAS SVs are acquired, only three of them will be prioritized over available GPS signals.
PRN Mask	Allows to selectively enable/disable SBAS satellite. With this parameter, for example, one can restrict SBAS usage to WAAS-only

By default SBAS is enabled with three prioritized SBAS channels and it will use any received SBAS satellites

(except for those in test mode) for navigation, ionosphere parameters and corrections.

NMEA Protocol Configuration

The [NMEA protocol](#) on u-blox receivers can be configured to the need of customer applications using [CFG-NMEA](#). As default all invalid positions out of the defined accuracy range are not reported.

There are two NMEA standards supported. The default NMEA protocol version is 2.3. Alternatively also Specification version 2.1 can be enabled (for details on how this affect the output refer to section [Position Fix Flags in NMEA Mode](#)).

NMEA filtering flags

Parameter	Description
Position filtering	If disabled, invalid or old position output is being communicated, but the valid flag indicates that the data is not current.
Masked position filtering	If disabled, Masked position data is still being output, but the valid flag will indicate that the defined accuracy range has been exceeded.
Time filtering	If disabled, the receiver's best knowledge of time is output, even though it might be wrong.
Date filtering	If disabled, the receiver's best knowledge of date is output, even though it might be wrong.
SBAS filtering	If enabled, SBAS satellites are reported according to the NMEA standard.
Track filtering	If disabled, an unfiltered course over ground (COG) output is being output.

NMEA flags

Parameter	Description
Compatibility Mode	Some NMEA applications only work with a fixed number of digits behind the decimal comma. Therefore u-blox receivers offer a compatibility mode to communicate with the most popular map applications.
Consideration Mode	u-blox receivers use a sophisticated signal quality detection scheme, in order to produce the best possible position output. This algorithm considers all SV measurements, and eventually decides to only use a subset thereof, if it improves the overall position accuracy. If Consideration mode is enabled, all Satellites, which were considered for navigation, are being communicated as being used for the position determination. If Consideration Mode is disabled, only those satellites are marked as being used, which after the consideration step remained in the position output.

Time Mode Configuration

This section relates to the configuration message [CFG-TMODE](#).

Introduction

Time Mode is a special stationary GPS receiver mode where the position of the receiver is known and fixed and only the time is calculated using all available satellites. This mode allows for maximum time accuracy as well as for single-SV solutions.

Fixed Position

In order to use the *Time Mode*, the receiver's position must be known as exactly as possible. Either the user already knows and enters the position, or it is determined using a [Survey-in](#). Errors in the fixed position will translate into time errors depending on the satellite constellation. Using the TDOP value (see [UBX-NAV-DOP](#)) and assuming a symmetrical 3D position error, the expected time error can be estimated as

```
time error = tdop * position error
```

As a rule of thumb the position should be known better than 1m for a time accuracy on the order of nanoseconds. If only microseconds accuracy is required, a position accuracy of roughly 300m is sufficient.

Survey-in

Survey-in is the procedure of determining a stationary receiver's position prior to using *Time Mode* by averaging. The current implementation builds a weighted mean of all valid 3D position solutions. Two stop criteria can be specified:

- The **minimum observation time** defines a minimum amount of observation time regardless of the actual number of valid fixes that were used for the position calculation. Reasonable values range from one day for high accuracy requirements to a few minutes for coarse position determination.
- The **required 3D position standard deviation** forces the calculated position to be of at least the given accuracy. As the position error translates into a time error when using *Time Mode* (see [above](#)), one should carefully evaluate the time accuracy requirements and choose an appropriate position accuracy requirement.

Survey-In ends, when **both** requirements are met. After Survey-In has finished successfully, the receiver will automatically enter fixed position *Time Mode*. The Survey-In status can be queried using the [UBX-TIM-SVIN](#) message.



The "Standard Deviation" parameter defines uncertainty of the manually provided "True Position" set of parameters. This uncertainty directly affects accuracy of the time pulse. This is to prevent an error that would otherwise be present in the time pulse because of the initially inaccurate position (assumed to be correct by the receiver) without user's being aware of it. The "Standard Deviation" parameter in "Fixed Position" as well as "Required position std dev" in "Survey-in" affect the produced time information and the time pulse in the same way. Please note that the availability of the position accuracy does not mitigate the error in the time pulse but only accounts for it when calculating the resulting time accuracy.

Navigation Configuration Settings Description

This section relates to the configuration message [CFG-NAV5](#).

Platform settings

u-blox 5 positioning technology supports different dynamic platform models to adjust the navigation engine to the expected environment. These platform settings can be changed dynamically without doing a power cycle or reset. It allows a better interpretation of the measurements and hence provides a more accurate position output. Setting the receiver to an unsuitable platform model for the application environment may reduce the receiver performance and position accuracy significantly.

Dynamic Platform Model

Platform	Description
Portable	Default setting. Applications with low accelerations, as any portable devices. Suitable for most situations. MAX Altitude [m]: 12000, MAX Velocity [m/s]: 310, MAX Vertical Velocity [m/s]: 50, Sanity check type: Altitude and Velocity, Max Position Deviation: Medium
Stationary	Used in timing applications (antenna must be stationary) or other stationary applications. Velocity is constrained to 0 m/s. Zero dynamics assumed. MAX Altitude [m]: 9000, MAX Velocity [m/s]: 10, MAX Vertical Velocity [m/s]: 6, Sanity check type: Altitude and Velocity, Max Position Deviation: Small
Pedestrian	Applications with low accelerations and low speed, as a pedestrian would move. Assuming low accelerations. MAX Altitude [m]: 9000, MAX Velocity [m/s]: 30, MAX Vertical Velocity [m/s]: 20, Sanity check type: Altitude and Velocity, Max Position Deviation: Small
Automotive	Used for applications that can be compared with the dynamics of a passenger car. Assuming low vertical acceleration. MAX Altitude [m]: 6000 (5000 for firmware versions 6.00 and below), MAX Velocity [m/s]: 84 (62 for firmware versions 4.00 to 5.00), MAX Vertical Velocity [m/s]: 15, Sanity check type: Altitude and Velocity, Max Position Deviation: Medium
At sea	Recommended for applications at sea, with zero vertical velocity. Assuming zero vertical velocity. MAX Altitude [m]: 500, MAX Velocity [m/s]: 25, MAX Vertical Velocity [m/s]: 5, Sanity check type: Altitude and Velocity, Max Position Deviation: Medium
Airborne <1g	Used for applications that have to handle a higher dynamic range than a car and higher vertical accelerations. No 2D position fixes supported. MAX Altitude [m]: 50000, MAX Velocity [m/s]: 100, MAX Vertical Velocity [m/s]: 100, Sanity check type: Altitude, Max Position Deviation: Large
Airborne <2g	Recommended for typical airborne environment. No 2D position fixes supported. MAX Altitude [m]: 50000, MAX Velocity [m/s]: 250, MAX Vertical Velocity [m/s]: 100, Sanity check type: Altitude, Max Position Deviation: Large
Airborne <4g	Only recommended for an extreme dynamic environment. No 2D position fixes supported. MAX Altitude [m]: 50000, MAX Velocity [m/s]: 500, MAX Vertical Velocity [m/s]: 100, Sanity check type: Altitude, Max Position Deviation: Large



Dynamic platforms designed for high acceleration systems (e.g. airborne <2g) may result in a greater standard deviation in the reported position.

Navigation Input Filters

The navigation input filters in [CFG-NAV5](#) mask the input data of the navigation engine.



These settings are already optimized. It is not recommended that changes to any parameters be made unless advised by u-blox support engineers.

Navigation Input Filter parameters

Parameter	Description
fixMode	By default, the receiver calculates a 3D position fix if possible but reverts to a 2D position if necessary (Auto 2D/3D). It is possible to force the receiver to permanently calculate 2D (2D only) or 3D (3D only) positions.
fixedAlt and fixedAltVar	The fixed altitude is used if fixMode is set to 2D only. A variance greater than zero must be supplied as well.

Navigation Input Filter parameters continued

Parameter	Description
minElev	Minimum elevation of a satellite above the horizon in order to be used in the navigation solution. Low elevation satellites may provide degraded accuracy, because of the long signal path through the atmosphere.
drLimit	Dead Reckoning limit: The time during which the receiver provides an extrapolated solution. After the DR timeout has expired, no GPS solution is provided at all.

Navigation Output Filters

The navigation output filters in [CFG-NAV5](#) adjust the valid flag of the relevant NMEA and UBX output messages. Users of the UBX protocol have additional access to messages containing an accuracy indicator, along with the position, time and velocity solutions.

- The **pDop** and **pAcc** values: The PDOP and Position Accuracy Mask are used to determine if a position solution is marked valid in the NMEA sentences or if the UBX `gpsFixOk` flag is set ([UBX-NAV-STATUS](#) and [UBX-NAV-SOL](#)). A solution is considered valid, when both PDOP and Accuracy lie below the respective limits.
- The **tDop** and **tAcc** values: The TDOP and Time Accuracy Mask are used to determine when a time pulse should be allowed. The time pulse is disabled if either TDOP or the time accuracy exceeds its respective limit. See also the [TIM-TP](#) message description.



Important: To qualify a position as valid the `gpsFixOK` flag in the [UBX-NAV-STATUS](#) message has to be checked. `gpsFix=3D/3D` in the [UBX-NAV-STATUS](#) message does not qualify a fix as valid and within the limits. To qualify a position as valid and within the `pDop` and `pAcc` limits set in the [UBX-CFG-NAV5](#) message the `gpsFixOK` flag in the [UBX-NAV-STATUS](#) message has to be checked.



Important: To qualify the speed information as valid the `gpsFixOK` flag in the [UBX-NAV-STATUS](#) message has to be checked.

Static Hold

The Static Hold mode allows the navigation algorithms to decrease the noise in the position output when the velocity is below a pre-defined 'Static Hold Threshold'. This reduces the position wander caused by environmental issues such as multi-path and improves position accuracy especially in stationary applications. By default, static hold mode is disabled.

If the speed goes below the defined 'Static Hold Threshold', the position is kept constant. Once the static hold mode has been entered, the position and velocity output will be kept constant, until there is evidence of movement. Such evidence can be velocity, acceleration, changes of the valid flag (e.g. position accuracy estimate exceeding the Position Accuracy Mask, see also section [Navigation Output Filters](#)), position displacement, etc.

Degraded Navigation

Degraded navigation describes all navigation modes, which use less than 4 satellites.

2D Navigation

If the receiver only has 3 satellites to calculate a position, the navigation algorithm uses a constant altitude to make up for the missing fourth satellite. When losing a satellite after a successful 3D fix (min. 4 SV available), the altitude is kept constant to the last known altitude. This is called a 2D fix.



The u-blox 5 positioning technology does not calculate any solution with a number of SVs less than 3. Only u-blox 5 Timing Receivers can calculate timing solution with only one SV when stationary.

Dead Reckoning, Extrapolating Positioning

The implemented extrapolation algorithm kicks in as soon as the receiver no longer achieves a position fix with a sufficient position accuracy or DOP value (see section [Navigation Output Filters](#)). It keeps a fix track (heading is equal to the last calculated heading) until the Dead Reckoning Timeout is reached. The position is extrapolated but it's indicated as "NoFix" (except for [NMEA V2.1](#)).

For sensor based Dead Reckoning GPS solutions, u-blox offers Dead Reckoning enabled GPS modules. They allow high accuracy position solutions for automotive applications at places with poor or no GPS coverage. This technology relies on additional inputs like a turn rate sensor (gyro) or a speed sensor (odometer or wheel tick).

Remote Inventory

Description

The *Remote Inventory* allows to store user-defined data in the non-volatile memory of the receiver. The data can be either binary or a string of ASCII characters. In the second case, it is possible to dump the data at startup.

Usage

- The contents of the *Remote Inventory* can be set and polled with the message [UBX-CFG-RINV](#). Refer to the specification of the message for a detailed description.
- If the contents of the *Remote Inventory* are polled without having been set before, the default configuration (see table below) is output.

Default configuration

Parameter	Value
flags	0x00
data	"Notice: no data saved! "



As with all changes of the configuration, they must be saved in order to be made permanent. So make sure to save the section *RINV* before resetting or switching off the receiver. More information about saving a configuration section can be found in chapter [Configuration Concept](#).

Receiver Status Monitoring

Messages in the UBX class [MON](#) are used to report the status of the non-GPS-specific parts of the embedded computer system.

The main purposes are

- Stack- and CPU load (Antaris 4, only)
- Hard- and Software Versions, using [MON-VER](#)
- Status of the Communications Input/Output system
- Status of various Hardware Sections with [MON-HW](#)

Input/Output system

The I/O system is a GPS-internal layer where all data input- and output capabilities (such as UART, DDC, SPI, USB) of the GPS receiver are combined. Each communications task has buffers assigned, where data is queued. For data originating at the receiver, to be communicated over one or multiple communications queues, the message [MON-TXBUF](#) can be used. This message shows the current and maximum buffer usage, as well as error conditions.



If too much data is being configured for a certain port's bandwidth (e.g. all UBX messages shall be output on a UART port with a baud rate of 9600), the buffer will fill up. Once the buffer's space is exceeded, the receiver will deactivate messages automatically.

Inbound data to the GPS receiver is placed in buffers. These buffers' usage are shown with the message [MON-RXBUF](#). Further, as data is then decoded within the receiver (e.g. to separate UBX- and NMEA data), the [MON-MSGPP](#) can be used. This message shows, for each port and protocol, how many messages were successfully received. It also shows, for each port, how many bytes were discarded because they were not in any of the supported protocol framings.

A target in the context of the I/O system is a I/O protocol. The following table shows the target numbers used

Target Number assignment

Target #	Electrical Interface
0	DDC (I2C compatible)
1	UART 1
2	UART 2
3	USB
4	SPI
5	reserved

Protocol Number assignment

Protocol #	Protocol Name
0	UBX Protocol
1	NMEA Protocol
2	RTCM Protocol (not supported on u-blox 5)
3	RAW Protocol (not supported on u-blox 5)
4..7	Reserved for future use

Jamming/Interference Indicator

The field `jamSuppr` of the `MON-HW` message can be used as an indicator for jammers/interference. The interpretation of the value depends on the application. It is necessary to run the receiver in the application and then calibrate the 'not jammed' case. The fact that the value rises significantly above this threshold, indicates that a continuous wave jammer is present.

Aiding and Acquisition

Introduction

The UBX Message Class AID provides all mechanisms for providing Assisted GPS Data to u-blox GPS receivers, including AssistNow Online and AssistNow Offline.

Startup Strategies

- **Coldstart:** In this startup mode, the receiver has no information about last position, time, velocity, frequency etc. Therefore, the receiver has to search the full time- and frequency space, and also all possible satellite numbers. If a satellite signal is found, it is being tracked to decode ephemeris (18-36 seconds under strong signal conditions), whereas the other channels continue to search satellites. Once there are sufficient number of satellites with valid ephemeris, the receiver can calculate position- and velocity data. Please note that some competitors call this startup mode Factory Startup.
- **Warmstart:** In Warmstart mode, the receiver has approximate information of time, position, and coarse data on Satellite positions (Almanac). In this mode, after power-up, the receiver basically needs to download ephemeris until it can calculate position- and velocity data. As the ephemeris data usually is outdated after 4 hours, the receiver will typically start with a warmstart if it was powered down for more than that amount of time. For this scenario, several augmentations exist. See the sections on AssistNOW online and offline below.
- **Hotstart:** In Hotstart, the receiver was powered down only for a short time (4 hours or less), so that its ephemeris is still valid. Since the receiver doesn't need to download ephemeris again, this is the fastest startup method. In the `UBX-CFG-RST` message, one can force the receiver to reset and clear data, in order to see the effects of maintaining/losing such a-priori data between restarts. For that, the `CFG-RST` message offers the `navBbrMaskfield`, where Hot-, Warm- and Coldstarts can be initiated, and also other combinations thereof.

Aiding / Assisted GPS (AGPS)

The Challenge of Stand-alone GPS

GPS users expect instant position information. With standard GPS this is not always possible because at least four satellites must transmit their precise orbital position data, called Ephemeris, to the GPS receiver. Under adverse signal conditions, data downloads from the satellites to the receiver can take minutes, hours or even fail altogether.

Assisted GPS (A GPS) boosts acquisition performance by providing data such as Ephemeris, Almanac, accurate time and satellite status to the GPS receiver via mobile networks or the Internet. The aiding data enables the receiver to compute a position within seconds, even under poor signal conditions.

Aiding Data

The following aiding data can be submitted to the receiver:

- **Position:** Position information can be submitted to the receiver using the [UBX-AID-INI](#) message. Both, ECEF X/Y/Z and latitude/longitude/height formats are supported.
- **Time:** The time can either be supplied as an inexact value via the standard communication interfaces, suffering from latency depending on the baud rate, or using hardware time synchronization where an accurate time pulse is connected to an external interrupt. Both methods are supported in the [UBX-AID-INI](#) message.
- **Frequency:** It is possible to supply hardware frequency aiding by connecting a continuous signal to an external interrupt using the [UBX-AID-INI](#) message.
- **Orbit data:** Orbit data can be submitted using [UBX-AID-ALM](#) and [UBX-AID-EPH](#).
- **Additional information:** [UBX-AID-HUI](#) can be used to supply health information, UTC parameters and ionospheric data to the receiver.

Aiding Sequence

A typical aiding sequence would comprise following steps:

- Power-up the GPS receiver
- Send [UBX-AID-INI](#) (time, clock and position) message.
- Send [UBX-AID-EPH](#) (ephemeris) message.
- Apply optional hardware time synchronization pulse within 0.5s after (or before, depending on the configuration in [UBX-AID-INI](#)) sending the [UBX-AID-INI](#) message if hardware time synchronization is required. When sending the message before applying the pulse, make sure to allow the GPS receiver to parse and process the aiding message. The time for parsing depends on the baud rate. The processing time is 100ms maximum.
- Send optional [UBX-AID-HUI](#) (health, UTC and ionosphere parameters) message.
- Send optional [UBX-AID-ALM](#) (almanac) message.

AssistNow Online

AssistNow Online is u-blox' end-to-end Assisted GPS (A-GPS) solution that boosts GPS acquisition performance, bringing Time To First Fix (TTFF) down to seconds. The system works by accessing assistance data such as Ephemeris, Almanac and accurate time from our Global Reference Network of globally placed GPS receivers. With A-GPS, the receiver can acquire satellites and provide accurate position data instantly on demand, even under poor signal conditions.

AssistNow Online makes use of User Plane communication and open standards such as TCP/IP. Therefore, it works on all standard mobile communication networks that support Internet access, including GPRS, UMTS and Wireless LAN. No special arrangements need to be made with mobile network operators to enable AssistNow Online.

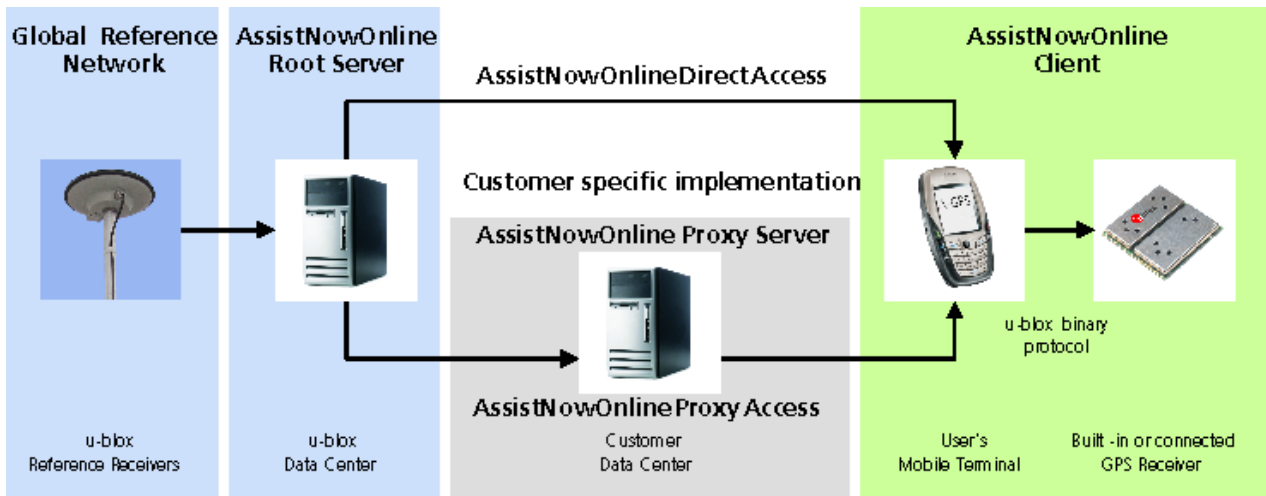

Messaging wise, AssistNow Online consists of Aiding data which deliver Position and Time [UBX-AID-INI](#), Ephemerides [UBX-AID-EPH](#), Almanac [UBX-AID-ALM](#) and Health/UTC/Iono information [UBX-AID-HUI](#)

AssistNow Offline

AssistNow Offline is an A-GPS service that boosts GPS acquisition performance, bringing Time To First Fix (TTFF) down to seconds. Unlike AssistNow Online, this solution enables instant positioning without the need for connectivity at start-up. The system works by using AlmanacPlus (ALP) differential almanac correction data to speed up acquisition, enabling a position fix within seconds. Users access the data by means of occasional Internet downloads, at the user's convenience.

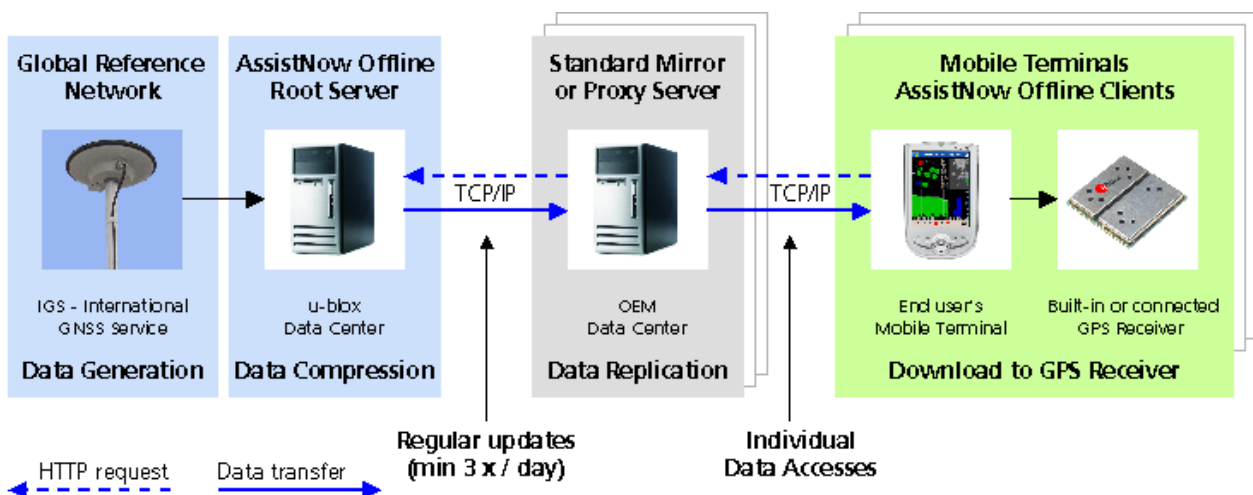

u-blox provides AlmanacPlus data files in different sizes, which contain differential almanac corrections that are valid for a period of between 1 and 14 days thereafter. Users can download correction data anytime they have an Internet connection. The GPS receiver stores the downloaded data in the non-volatile memory. As an alternative, a host CPU may store the file, but deliver the data in pieces when requested.

AssistNow Offline works in locations without any wireless connectivity as the correction data files reside in the receiver or the host. This makes them immediately available upon start-up, eliminating connection set-up delays, download waiting times and call charges.

The simplest set-up is for GPS receivers including an internal Flash Memory or an external SPI Flash Memory where ALP data can be stored. In this case, the [UBX-AID-ALP](#) message is used.

When the GPS receiver has neither an internal Flash Memory nor an external SPI Flash Memory, the ALP file

must be stored to the host CPU. The GPS receiver can then request data from the host when needed. This arrangement is implemented using the [UBX-AID-ALPSRV](#) message.

In both cases, status reporting on ALP data currently available to the GPS receiver can be taken from message [AID-ALP_STAT](#).

AssistNow Offline data are published at <http://alp.u-blox.com/>.

Host-based AlmanacPlus Overview



Please note that this functionality is only supported on u-blox 5 Firmware 4.0 and above.

All three versions of AID-ALPSRV messages are used for the case where the storage of an ALP file is not within the receiver's Flash memory, but on the host, and where the host needs to deliver data to the GPS receiver repeatedly. This allows support of the AlmanacPlus functionality for GPS receivers which do not have a Flash memory. For messaging details of an implementation where the data is to reside in the receiver's Flash memory, see [UBX-AID-ALP-DESC](#)

In the following, the GPS receiver is called the **client**, as it primarily requests data, and the host CPU where the ALP file is located in its entirety is called the **server**.

The operation is such that the client sends periodic data requests (the ALP client requests [ALPSRV-REQ](#)) to the host, and the host should answer them accordingly, as described below at [ALPSRV-SRV](#)



For this mechanism to work, the [AID-ALPSRV](#) message needs to be activated using the normal [CFG-MSG](#) commands. If it is not activated, no requests are sent out.

The client may attempt to modify the data which is stored on the server, using the [ALPSRV-CLI](#) message. The server may safely ignore such a request, in case the ALP file can not be modified. However, for improved performance for consecutive receiver restarts, it is recommended to modify the data.

Overview of the three versions of AID-ALPSRV messages

Short Name	Content	Direction
ALPSRV-REQ	ALP client requests AlmanacPlus data from server	Client -> Server
ALPSRV-SRV	ALP server sends AlmanacPlus data to client	Server -> Client
ALPSRV-CLI	ALP client sends AlmanacPlus data to server.	Client -> Server

Message specifics

The three variants of this message always have a header and variable-size data appended within the same message. The very first field, `idSize` gives the number of bytes where the header within the UBX payload ends and data starts.

In case of the ALP client request, the server must assemble a new message according to the [AID-ALPSRV-SRV](#) variant. The header needs to be duplicated for as many as `idSize` bytes. Additionally, the server needs to fill in the `fileId` and `dataSize` fields. Appended to the `idSize`-sized header, data must be added as requested by the client (from offset `ofs`, for `size` number of values).

Range checks

The server needs to perform an out-of-bounds check on the `ofs` (offsets) and `size` fields, as the client may request data beyond the actually available data. If the client request is within the bounds of available data, the `dataSize` field needs to be filled in with 2 x the content of the `size` field (the `size` field is in units of 16 bits, whereas the `dataSize` field expects number of bytes). If the client request would request data beyond the limits of the buffer, the data should be reduced accordingly, and this actual number of bytes sent shall be indicated in the `dataSize` field

Changing ALP files

The server function would periodically attempt to receive new ALP data from an upstream server, as the result of an HTTP request or other means of file transfer.

In case a new file becomes available, then the server shall indicate this to the Client. This is the function of the `fileId` field.

The server should number ALP files it serves arbitrarily. The only requirement is that the `fileId` actually is changed when a new file is being served, and that it does not change as long as the same file is being changed.

If the client, as a result of a client request, receives a `fileId` different from the one in earlier requests' replies, it will reinitialize the ALP engine and request data anew.

Further, if the client attempts to send data to the server, using the [ALPSRV-CLI](#) method, it indicates, which `fileId` needs to be written. The server shall ignore that request in case the `fileId` numbers do not match.

Sample Code

u-blox makes available sample code, written in C language, showing a server implementation, serving ALP data from its file system to a client. Please contact your nearest u-blox Field Application engineer to receive a copy.

Flash-based AlmanacPlus Overview



Please note that this functionality is only supported on u-blox 5 Firmware 4.0 and above and with special versions of Antaris 4 receivers.

Flash-based AlmanacPlus functionality means that AlmanacPlus data is stored in the program flash memory connected to the u-blox 5 chip.

The task of a server is simply to download the data from an Internet server or other sources, and then deliver the full file piece by piece to the GPS receiver. This is different to the method described in [UBX-AID-ALPSRV](#) where the file would remain within the host and the GPS receiver would request chunks from that file when needed.

The message AID-ALP exists in several variants, combining all functionality needed to download data and report status within one Class/Message ID.

Download Procedure

The following steps are a typical sequence for downloading an ALP file to the receiver:

- The server downloads a copy of a current ALP file, and stores it locally
- It sends the first \mathfrak{N} bytes from that file, using the [AID-ALP-TX](#) message
- The server awaits a [AID-ALP-ACK](#) or [AID-ALP-NAK](#) message.
- If can then continue, sending the next \mathfrak{N} bytes if the message was acknowledged.
- Once all data has been transferred, or a NAK has been received, the server sends an [AID-ALP-STOP](#) message

Please note that

- \mathfrak{N} should not be larger than ~700 bytes (due to the input buffers on the RS232/USB lines). Smaller values of \mathfrak{N} might improve reliability
- \mathfrak{N} must be a multiple of 2.
- There is no re-send mechanism. If a NAK message is received, the full downloading process must be restarted.
- There is no explicit checksum, but an implicit one, as the ALP file already includes a checksum to verify consistency

Overview of the different versions of AID-ALP messages

Short Name	Content	Direction
AID-ALP-TX	ALP server sends Data to client	Server -> Client
AID-ALP-STOP	ALP server terminates a transfer sequence	Server -> Client
AID-ALP-ACK	ALP client acknowledges successful receipt of data.	Client -> Server
AID-ALP-NAK	ALP client indicates a failed reception of data	Client -> Server
AID-ALP-STAT	ALP client reports status of the ALP data stored in flash memory	Client -> Server

Timemark

The receiver can be used for time measurements with a sub millisecond resolution using the external interrupt. The reference time can be chosen by setting the time source parameter to GPS, UTC or local time in the [UBX-CFG-TP](#) configuration message. The delay figures defined with [UBX-CFG-TP](#) are also applied to the results output in the [UBX-TIM-TM2](#) message.

A [UBX-TIM-TM2](#) message is output at the next epoch if

- the [UBX-TIM-TM2](#) message is enabled
- a rising or falling edge was triggered since last epoch on one of the EXTINT channels

The [UBX-TIM-TM2](#) messages include time of the last timemark, new rising/falling edge indicator, time source, validity, number of marks and a quantization error. The timemark is triggered continuously.



Only the last rising and falling edge detected between two epochs is reported since the output rate of the [UBX-TIM-TM2](#) message corresponds to the measurement rate configured with [UBX-CFG-RATE](#) (see Figure below).

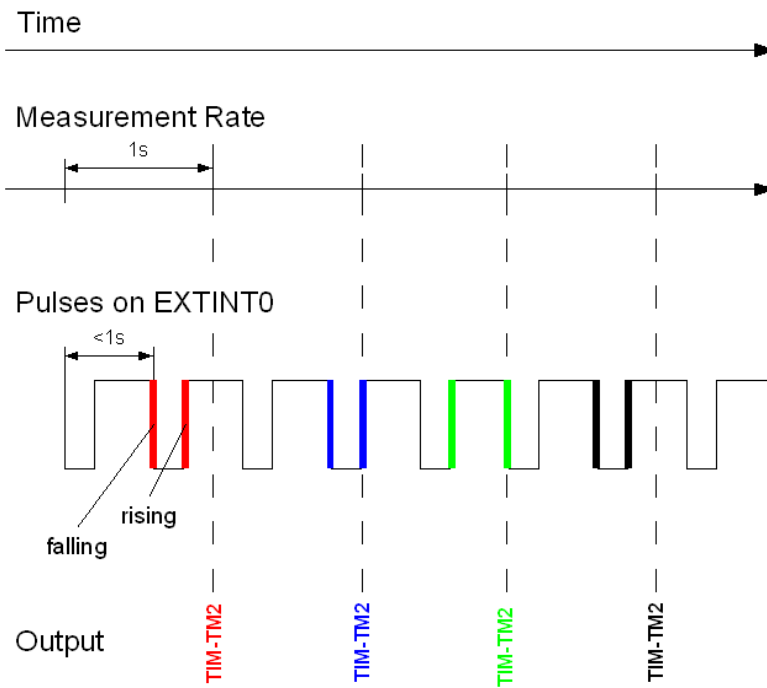

NMEA Protocol

Protocol Overview

NMEA messages sent by the GPS receiver are based on NMEA 0183 Version 2.3. The following picture shows the structure of a NMEA protocol message.

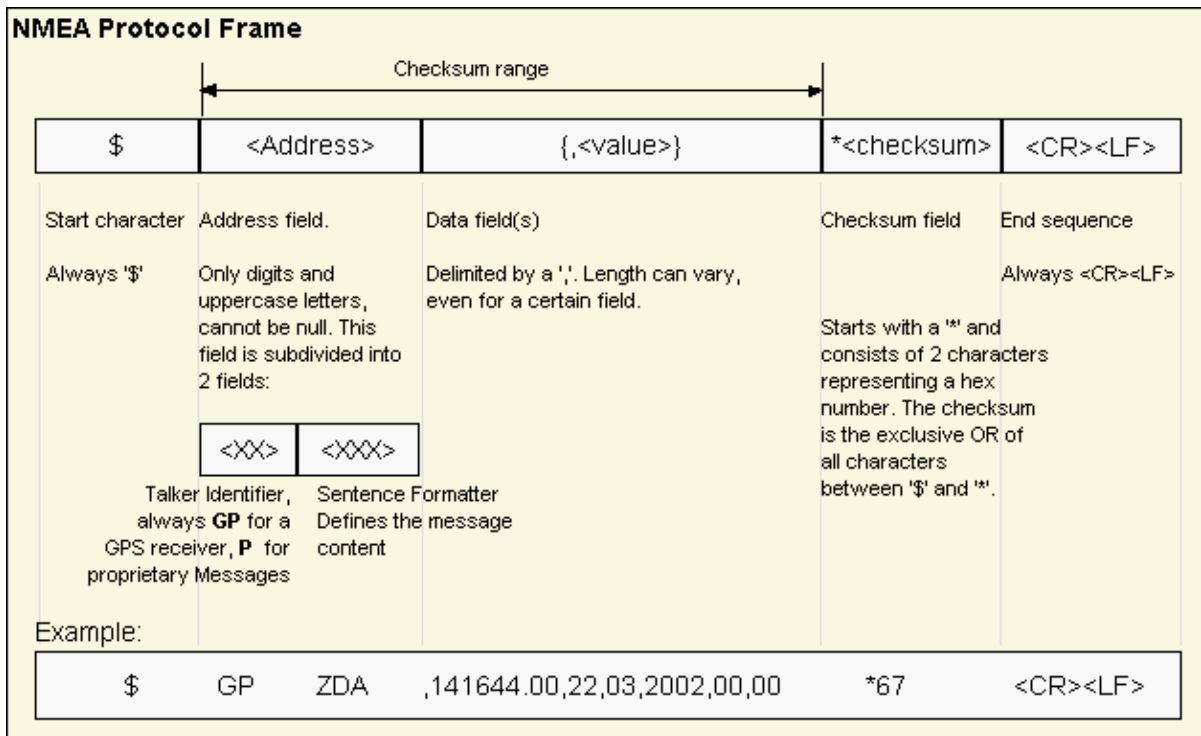

For further information on the NMEA Standard please refer to *NMEA 0183 Standard For Interfacing Marine Electronic Devices*, Version 2.30, March 1, 1998. See <http://www.nmea.org/> for ordering instructions.

The NMEA standard allows for proprietary, manufacturer-specific messages to be added. These shall be marked with a manufacturer mnemonic. The mnemonic assigned to u-blox is UBX and is used for all non-standard messages. These proprietary NMEA messages therefore have the address field set to PUBX. The first data field in a PUBX message identifies the message number with two digits.

Latitude and Longitude Format

According to the NMEA Standard, Latitude and Longitude are output in the format Degrees, Minutes and (Decimal) Fractions of Minutes. To convert to Degrees and Fractions of Degrees, or Degrees, Minutes, Seconds and Fractions of seconds, the 'Minutes' and 'Fractional Minutes' parts need to be converted. In other words: If the GPS Receiver reports a Latitude of 4717.112671 North and Longitude of 00833.914843 East, this is

Latitude 47 Degrees, 17.112671 Minutes

Longitude 8 Degrees, 33.914843 Minutes

or

Latitude 47 Degrees, 17 Minutes, 6.76026 Seconds

Longitude 8 Degrees, 33 Minutes, 54.89058 Seconds

or

Latitude 47.28521118 Degrees

Longitude 8.56524738 Degrees

Position Fix Flags in NMEA Mode

The following list shows how u-blox implements the NMEA protocol, and the conditions determining how flags are set in version 2.3 and above.

NMEA Message: Field	No position fix (at power-up, after losing satellite lock)	Valid position fix, but user limits exceeded	Dead reckoning (linear extrapolation)	EKF (only on DR receivers)	2D position fix	3D position fix	combined GPS/EKF position fix (only on DR receivers)
GLL, RMC: Status	V	V	V	A	A	A	A
A=Data VALID, V=Data Invalid (Navigation Receiver Warning)							
GGA: Quality Indicator	0	0	6	6	1 / 2	1 / 2	1 / 2
0=Fix not available/invalid, 1=GPS SPS Mode, Fix valid, 2=Differential GPS, SPS Mode, Fix Valid, 6=Estimated/Dead Reckoning							
GSA: Nav Mode	1	1	2	2	2	3	3
1=Fix Not available, 2=2D Fix, 3=3D Fix							
GLL, RMC, VTG: Mode Indicator	N	N	E	E	A / D	A / D	A / D
N=No Fix, A=Autonomous GNSS Fix, D=Differential GNSS Fix, E=Estimated/Dead Reckoning Fix							
UBX GPSTxOK	0	0	0	1	1	1	1
UBX GPSTx	0	>1	1	1	2	3	4

The following list shows how u-blox implements the NMEA protocol, and the conditions determining how flags are set in version 2.2 and below.

NMEA Message: Field	No position fix (at power-up, after losing satellite lock)	Valid position fix, but user limits exceeded	Dead reckoning (linear extrapolation)	EKF (only on DR receivers)	2D position fix	3D position fix	combined GPS/EKF position fix (only on DR receivers)
GLL, RMC: Status	V	V	A	A	A	A	A
A=Data VALID, V=Data Invalid (Navigation Receiver Warning)							
GGA: Quality Indicator	0	0	1	1	1 / 2	1 / 2	1 / 2
0=Fix not available/invalid, 1=GPS SPS Mode, Fix valid, 2=Differential GPS, SPS Mode, Fix Valid							
GSA: Nav Mode	1	1	2	2	2	3	3
1=Fix Not available, 2=2D Fix, 3=3D Fix							
GLL, RMC, VTG: Mode Indicator. This field is not output by this NMEA version.							
UBX GPSTxOK	0	0	0	1	1	1	1
UBX GPSTx	0	>1	1	1	2	3	4



By default the receiver will not output invalid data. In such cases, it will output empty fields.

- A valid position fix is reported as follows:

```
$GPGLL, 4717.11634,N, 00833.91297,E, 124923.00,A,A*6E
```

- An invalid position fix (but time valid) is reported as follows:

```
$GPGLL, , , , , 124924.00,V,N*42
```

- If Time is unknown (e.g. during a cold-start):

```
$GPGLL, , , , , V,N*64
```



In Antaris firmware versions older than 3.0, the receiver did output invalid data and marked it with the 'Invalid/Valid' Flags. If required, this function can still be enabled in later firmware versions, using the UBX protocol message [CFG-NMEA](#).

NMEA Messages Overview

When configuring NMEA messages using the UBX protocol message [CFG-MSG](#), the Class/Ids shown in the table shall be used.

Page	Mnemonic	Cls/ID	Description
NMEA Proprietary Messages		Proprietary Messages	
55	UBX,00	0xF1 0x00	Lat/Long Position Data
57	UBX,03	0xF1 0x03	Satellite Status
59	UBX,04	0xF1 0x04	Time of Day and Clock Information
61	UBX,40	0xF1 0x40	Set NMEA message output rate
62	UBX,41	0xF1 0x41	Set Protocols and Baudrate
60	UBX	0xF1 0x40	Poll a PUBX message
NMEA Standard Messages		Standard Messages	
52	DTM	0xF0 0x0A	Datum Reference
51	GBS	0xF0 0x09	GNSS Satellite Fault Detection
41	GGA	0xF0 0x00	Global positioning system fix data
43	GLL	0xF0 0x01	Latitude and longitude, with time of position fix and status
53	GPQ	0xF0 0x40	Poll message
48	GRS	0xF0 0x06	GNSS Range Residuals
44	GSA	0xF0 0x02	GNSS DOP and Active Satellites
49	GST	0xF0 0x07	GNSS Pseudo Range Error Statistics
45	GSV	0xF0 0x03	GNSS Satellites in View
46	RMC	0xF0 0x04	Recommended Minimum data
54	TXT	0xF0 0x41	Text Transmission
47	VTG	0xF0 0x05	Course over ground and Ground speed
50	ZDA	0xF0 0x08	Time and Date

Standard Messages

Standard Messages : i.e. Messages as defined in the NMEA Standard.

GGA

Message	GGA		
Description	Global positioning system fix data		
Firmware	Supported on u-blox 5 from firmware version 4.00 up to version 6.02.		
Type	Output Message		
Comment	The output of this message is dependent on the currently selected datum (Default: WGS84) Time and position, together with GPS fixing related data (number of satellites in use, and the resulting HDOP, age of differential data if in use, etc.).		
Message Info	<i>ID for CFG-MSG</i>	<i>Number of fields</i>	
	0xF0 0x00	17	

Message Structure:

```
$GPGGA,hhmmss.ss,Latitude,N,Longitude,E,FS,NoSV,HDOP,msl,m,Altref,m,DiffAge,DiffStation*cs<CR><LF>
```

Example:

```
$GPGGA,092725.00,4717.11399,N,00833.91590,E,1,8,1.01,499.6,M,48.0,M,,0*5B
```

Field No.	Example	Format	Name	Unit	Description
0	\$GPGGA	string	\$GPGGA	-	Message ID, GGA protocol header
1	092725.00	hhmmss.sss	hhmmss.ss	-	UTC Time, Current time
2	4717.11399	ddmm.mmmm	Latitude	-	Latitude, Degrees + minutes, see Format description
3	N	character	N	-	N/S Indicator, N=north or S=south
4	00833.91590	dddmm.mmmm	Longitude	-	Longitude, Degrees + minutes, see Format description
5	E	character	E	-	E/W indicator, E=east or W=west
6	1	digit	FS	-	Position Fix Status Indicator, See Table below and Position Fix Flags description
7	8	numeric	NoSV	-	Satellites Used, Range 0 to 12
8	1.01	numeric	HDOP	-	HDOP, Horizontal Dilution of Precision
9	499.6	numeric	msl	m	MSL Altitude
10	M	character	uMsl	-	Units, Meters (fixed field)
11	48.0	numeric	Altref	m	Geoid Separation
12	M	character	uSep	-	Units, Meters (fixed field)
13	-	numeric	DiffAge	s	Age of Differential Corrections, Blank (Null) fields when DGPS is not used
14	0	numeric	DiffStation	-	Diff. Reference Station ID
15	*5B	hexadecimal	cs	-	Checksum
16	-	character	<CR><LF>	-	Carriage Return and Line Feed

Table Fix Status

<i>Fix Status</i>	<i>Description, see also Position Fix Flags description</i>
0	No Fix / Invalid
1	Standard GPS (2D/3D)
2	Differential GPS
6	Estimated (DR) Fix

GLL

Message	GLL		
Description	Latitude and longitude, with time of position fix and status		
Firmware	Supported on u-blox 5 from firmware version 4.00 up to version 6.02.		
Type	Output Message		
Comment	The output of this message is dependent on the currently selected datum (Default: WGS84) -		
Message Info	<i>ID for CFG-MSG</i>	<i>Number of fields</i>	
	0xF0 0x01	(9) or (10)	

Message Structure:

```
$GPGLL, Latitude, N, Longitude, E, hhmmss.ss, Valid, Mode*cs<CR><LF>
```

Example:

```
$GPGLL, 4717.11364, N, 00833.91565, E, 092321.00, A, A*60
```

Field No.	Example	Format	Name	Unit	Description
0	\$GPGLL	string	\$GPGLL	-	Message ID, GLL protocol header
1	4717.11364	ddmm.mmmm	Latitude	-	Latitude, Degrees + minutes, see Format description
2	N	character	N	-	N/S Indicator, hemisphere N=north or S=south
3	00833.91565	dddmm.mmmm	Longitude	-	Longitude, Degrees + minutes, see Format description
4	E	character	E	-	E/W indicator, E=east or W=west
5	092321.00	hhmmss.sss	hhmmss.ss	-	UTC Time, Current time
6	A	character	Valid	-	V = Data invalid or receiver warning, A = Data valid. See Position Fix Flags description
<i>Start of optional block</i>					
7	A	character	Mode	-	Positioning Mode, see Position Fix Flags description
<i>End of optional block</i>					
7	*60	hexadecimal	cs	-	Checksum
8	-	character	<CR><LF>	-	Carriage Return and Line Feed

GSA

Message	GSA		
Description	GNSS DOP and Active Satellites		
Firmware	Supported on u-blox 5 from firmware version 4.00 up to version 6.02.		
Type	Output Message		
Comment	<ul style="list-style-type: none"> If less than 12 SVs are used for navigation, the remaining fields are left empty. If more than 12 SVs are used for navigation, only the IDs of the first 12 are output. The SV Numbers (Fields 'Sv') are in the range of 1 to 32 for GPS satellites, and 33 to 64 for SBAS satellites (33 = SBAS PRN 120, 34 = SBAS PRN 121, and so on) 		
Message Info	<i>ID for CFG-MSG</i>	<i>Number of fields</i>	
	0xF0 0x02	20	

Message Structure:

```
$GPGSA, Smode, FS{ ,sv}, PDOP, HDOP, VDOP*cs<CR><LF>
```

Example:

```
$GPGSA,A,3,23,29,07,08,09,18,26,28,,,,,1.94,1.18,1.54*0D
```

Field No.	Example	Format	Name	Unit	Description
0	\$GPGSA	string	\$GPGSA	-	Message ID, GSA protocol header
1	A	character	Smode	-	Smode, see first table below
2	3	digit	FS	-	Fix status, see second table below and Position Fix Flags description
<i>Start of repeated block (12 times)</i>					
3 + 1*N	29	numeric	sv	-	Satellite number
<i>End of repeated block</i>					
15	1.94	numeric	PDOP	-	Position dilution of precision
16	1.18	numeric	HDOP	-	Horizontal dilution of precision
17	1.54	numeric	VDOP	-	Vertical dilution of precision
18	*0D	hexadecimal	cs	-	Checksum
19	-	character	<CR><LF>	-	Carriage Return and Line Feed

Table Smode

Smode	Description
M	Manual - forced to operate in 2D or 3D mode
A	Allowed to automatically switch 2D/3D mode

Table Fix Status

Fix Status	Description, see also Position Fix Flags description
1	Fix not available
2	2D Fix
3	3D Fix

GSV

Message	GSV		
Description	GNSS Satellites in View		
Firmware	Supported on u-blox 5 from firmware version 4.00 up to version 6.02.		
Type	Output Message		
Comment	The number of satellites in view, together with each PRN (SV ID), elevation and azimuth, and C/No (Signal/Noise Ratio) value. Only four satellite details are transmitted in one message.		
Message Info	<i>ID for CFG-MSG</i>	<i>Number of fields</i>	
	0xF0 0x03	7..16	

Message Structure:

```
$GPGSV, NoMsg, MsgNo, NoSv, { , sv, elv, az, cno } *cs <CR> <LF>
```

Example:

```
$GPGSV, 3, 1, 10, 23, 38, 230, 44, 29, 71, 156, 47, 07, 29, 116, 41, 08, 09, 081, 36 *7F
```

```
$GPGSV, 3, 2, 10, 10, 07, 189, , 05, 05, 220, , 09, 34, 274, 42, 18, 25, 309, 44 *72
```

```
$GPGSV, 3, 3, 10, 26, 82, 187, 47, 28, 43, 056, 46 *77
```

Field No.	Example	Format	Name	Unit	Description
0	\$GPGSV	string	\$GPGSV	-	Message ID, GSV protocol header
1	3	digit	NoMsg	-	Number of messages, total number of GPGSV messages being output
2	1	digit	MsgNo	-	Number of this message
3	10	numeric	NoSv	-	Satellites in View
<i>Start of repeated block (1..4 times)</i>					
4 + 4*N	23	numeric	sv	-	Satellite ID
5 + 4*N	38	numeric	elv	degrees	Elevation, range 0..90
6 + 4*N	230	numeric	az	degrees	Azimuth, range 0..359
7 + 4*N	44	numeric	cno	dBHz	C/N0, range 0..99, null when not tracking
<i>End of repeated block</i>					
5.. 16	*7F	hexadecimal	cs	-	Checksum
6.. 16	-	character	<CR><LF>	-	Carriage Return and Line Feed

RMC

Message	RMC		
Description	Recommended Minimum data		
Firmware	Supported on u-blox 5 from firmware version 4.00 up to version 6.02.		
Type	Output Message		
Comment	The output of this message is dependent on the currently selected datum (Default: WGS84) The Recommended Minimum sentence defined by NMEA for GPS/Transit system data.		
Message Info	<i>ID for CFG-MSG</i>	<i>Number of fields</i>	
	0xF0 0x04	15	

Message Structure:

```
$GPRMC,hhmmss,status,latitude,N,longitude,E,spd,cog,ddmmyy,mv,mvE,mode*cs<CR><LF>
```

Example:

```
$GPRMC,083559.00,A,4717.11437,N,00833.91522,E,0.004,77.52,091202,,,A*57
```

Field No.	Example	Format	Name	Unit	Description
0	\$GPRMC	string	\$GPRMC	-	Message ID, RMC protocol header
1	083559.00	hhmmss.sss	hhmmss.ss	-	UTC Time, Time of position fix
2	A	character	Status	-	Status, V = Navigation receiver warning, A = Data valid, see Position Fix Flags description
3	4717.11437	ddmm.mmmm	Latitude	-	Latitude, Degrees + minutes, see Format description
4	N	character	N	-	N/S Indicator, hemisphere N=north or S=south
5	00833.91522	dddmm.mmmm	Longitude	-	Longitude, Degrees + minutes, see Format description
6	E	character	E	-	E/W indicator, E=east or W=west
7	0.004	numeric	Spd	knots	Speed over ground
8	77.52	numeric	Cog	degrees	Course over ground
9	091202	ddmmyy	date	-	Date in day, month, year format
10	-	numeric	mv	degrees	Magnetic variation value, not being output by receiver
11	-	character	mvE	-	Magnetic variation EW indicator, not being output by receiver
12	-	character	mode	-	Mode Indicator, see Position Fix Flags description
13	*57	hexadecimal	cs	-	Checksum
14	-	character	<CR><LF>	-	Carriage Return and Line Feed

VTG

Message	VTG		
Description	Course over ground and Ground speed		
Firmware	Supported on u-blox 5 from firmware version 4.00 up to version 6.02.		
Type	Output Message		
Comment	Velocity is given as Course over Ground (COG) and Speed over Ground (SOG).		
Message Info	<i>ID for CFG-MSG</i>	<i>Number of fields</i>	
	0xF0 0x05	12	

Message Structure:

```
$GPVTG,cogt,T,cogm,M,sog,N,kph,K,mode*cs<CR><LF>
```

Example:

```
$GPVTG,77.52,T,,M,0.004,N,0.008,K,A*06
```

Field No.	Example	Format	Name	Unit	Description
0	\$GPVTG	string	\$GPVTG	-	Message ID, VTG protocol header
1	77.52	numeric	cogt	degrees	Course over ground (true)
2	T	character	T	-	Fixed field: true
3	-	numeric	cogm	degrees	Course over ground (magnetic), not output
4	M	character	M	-	Fixed field: magnetic
5	0.004	numeric	sog	knots	Speed over ground
6	N	character	N	-	Fixed field: knots
7	0.008	numeric	kph	km/h	Speed over ground
8	K	character	K	-	Fixed field: kilometers per hour
9	A	character	mode	-	Mode Indicator, see Position Fix Flags description
10	*06	hexadecimal	cs	-	Checksum
11	-	character	<CR><LF>	-	Carriage Return and Line Feed

GRS

Message	GRS		
Description	GNSS Range Residuals		
Firmware	Supported on u-blox 5 from firmware version 4.00 up to version 6.02.		
Type	Output Message		
Comment	This messages relates to associated GGA and GSA messages. If less than 12 SVs are available, the remaining fields are output empty. If more than 12 SVs are used, only the residuals of the first 12 SVs are output, in order to remain consistent with the NMEA standard.		
Message Info	<i>ID for CFG-MSG</i>	<i>Number of fields</i>	
	0xF0 0x06	17	

Message Structure:

```
$GPGRS,hhmmss.ss, mode {,residual}*cs<CR><LF>
```

Example:

```
$GPGRS,082632.00,1,0.54,0.83,1.00,1.02,-2.12,2.64,-0.71,-1.18,0.25,,,*70
```

Field No.	Example	Format	Name	Unit	Description
0	\$GPGRS	string	\$GPGRS	-	Message ID, GRS protocol header
1	082632.00	hhmmss.sss	hhmmss.ss	-	UTC Time, Time of associated position fix
2	1	digit	mode	-	Mode (see table below), u-blox receivers will always output Mode 1 residuals
<i>Start of repeated block (12 times)</i>					
3 + 1*N	0.54	numeric	residual	m	Range residuals for SVs used in navigation. The SV order matches the order from the GSA sentence .
<i>End of repeated block</i>					
15	*70	hexadecimal	cs	-	Checksum
16	-	character	<CR><LF>	-	Carriage Return and Line Feed

Table Mode

Mode	Description
0	Residuals were used to calculate the position given in the matching GGA sentence .
1	Residuals were recomputed after the GGA position was computed.

GST

Message	GST		
Description	GNSS Pseudo Range Error Statistics		
Firmware	Supported on u-blox 5 from firmware version 4.00 up to version 6.02.		
Type	Output Message		
Comment	-		
Message Info	<i>ID for CFG-MSG</i>	<i>Number of fields</i>	
	0xF0 0x07	11	

Message Structure:

```
$GPGST, hhmmss.ss, range_rms, std_major, std_minor, hdg, std_lat, std_long, std_alt*cs<CR><LF>
```

Example:

```
$GPGST, 082356.00, 1.8, , , , 1.7, 1.3, 2.2*7E
```

Field No.	Example	Format	Name	Unit	Description
0	\$GPGST	string	\$GPGST	-	Message ID, GST protocol header
1	082356.00	hhmmss.sss	hhmmss.ss	-	UTC Time, Time of associated position fix
2	1.8	numeric	range_rms	m	RMS value of the standard deviation of the ranges
3	-	numeric	std_major	m	Standard deviation of semi-major axis, not supported (empty)
4	-	numeric	std_minor	m	Standard deviation of semi-minor axis, not supported (empty)
5	-	numeric	hdg	degrees	Orientation of semi-major axis, not supported (empty)
6	1.7	numeric	std_lat	m	Standard deviation of latitude, error in meters
7	1.3	numeric	std_long	m	Standard deviation of longitude, error in meters
8	2.2	numeric	std_alt	m	Standard deviation of altitude, error in meters
9	*7E	hexadecimal	cs	-	Checksum
10	-	character	<CR><LF>	-	Carriage Return and Line Feed

ZDA

Message	ZDA		
Description	Time and Date		
Firmware	Supported on u-blox 5 from firmware version 4.00 up to version 6.02.		
Type	Output Message		
Comment	-		
Message Info	<i>ID for CFG-MSG</i>	<i>Number of fields</i>	
	0xF0 0x08	9	

Message Structure:

```
$GPZDA,hhmmss.ss,day,month,year,ltzh,ltzn*cs<CR><LF>
```

Example:

```
$GPZDA,082710.00,16,09,2002,00,00*64
```

Field No.	Example	Format	Name	Unit	Description
0	\$GPZDA	string	\$GPZDA	-	Message ID, ZDA protocol header
1	082710.00	hhmmss.sss	hhmmss.ss	-	UTC Time
2	16	dd	day	day	UTC time: day, 01..31
3	09	mm	month	month	UTC time: month, 01..12
4	2002	yyyy	year	year	UTC time: 4 digit year
5	00	-xx	ltzh	-	Local zone hours, not supported (fixed to 00)
6	00	zz	ltzn	-	Local zone minutes, not supported (fixed to 00)
7	*64	hexadecimal	cs	-	Checksum
8	-	character	<CR><LF>	-	Carriage Return and Line Feed

GBS

Message	GBS		
Description	GNSS Satellite Fault Detection		
Firmware	Supported on u-blox 5 from firmware version 4.00 up to version 6.02.		
Type	Output Message		
Comment	<p>This message outputs the results of the Receiver Autonomous Integrity Monitoring Algorithm (RAIM).</p> <ul style="list-style-type: none"> The fields errlat, errlon and erralt output the standard deviation of the position calculation, using all satellites which pass the RAIM test successfully. The fields errlat, errlon and erralt are only output if the RAIM process passed successfully (i.e. no or successful Edits happened). These fields are never output if 4 or fewer satellites are used for the navigation calculation (because - in this case - integrity can not be determined by the receiver autonomously) The fields prob, bias and stdev are only output if at least one satellite failed in the RAIM test. If more than one satellites fail the RAIM test, only the information for the worst satellite is output in this message. 		
Message Info	<i>ID for CFG-MSG</i>	<i>Number of fields</i>	
	0xF0 0x09	11	

Message Structure:

```
$GPGBS,hhmmss.ss,errlat,errlon,erralt,svid,prob,bias,stdev*cs<CR><LF>
```

Example:

```
$GPGBS,235503.00,1.6,1.4,3.2,,,,*40
```

```
$GPGBS,235458.00,1.4,1.3,3.1,03,,-21.4,3.8*5B
```

Field No.	Example	Format	Name	Unit	Description
0	\$GPGBS	string	\$GPGBS	-	Message ID, GBS protocol header
1	235503.00	hhmmss.sss	hhmmss.ss	-	UTC Time, Time to which this RAIM sentence belongs
2	1.6	numeric	errlat	m	Expected error in latitude
3	1.4	numeric	errlon	m	Expected error in longitude
4	3.2	numeric	erralt	m	Expected error in altitude
5	03	numeric	svid	-	Satellite ID of most likely failed satellite
6	-	numeric	prob	-	Probability of missed detection, no supported (empty)
7	-21.4	numeric	bias	m	Estimate on most likely failed satellite (a priori residual)
8	3.8	numeric	stdev	m	Standard deviation of estimated bias
9	*40	hexadecimal	cs	-	Checksum
10	-	character	<CR><LF>	-	Carriage Return and Line Feed

DTM

Message	DTM		
Description	Datum Reference		
Firmware	Supported on u-blox 5 from firmware version 4.00 up to version 6.02.		
Type	Output Message		
Comment	<p>This message gives the difference between the currently selected Datum, and the reference Datum.</p> <p>If the currently configured Datum is not WGS84 or WGS72, then the field LLL will be set to 999, and the field LSD is set to a variable-length string, representing the Name of the Datum. The list of supported datums can be found in CFG-DAT.</p> <p>The reference Datum can not be changed and is always set to WGS84.</p>		
Message Info	<i>ID for CFG-MSG</i>	<i>Number of fields</i>	
	0xF0 0x0A	11	

Message Structure:

```
$GPDTM,LLL,LSD,lat,N/S,lon,E/W,alt,RRR*cs<CR><LF>
```

Example:

```
$GPDTM,W84,,0.0,N,0.0,E,0.0,W84*6F
```

```
$GPDTM,W72,,0.00,S,0.01,W,-2.8,W84*4F
```

```
$GPDTM,999,CH95,0.08,N,0.07,E,-47.7,W84*1C
```

Field No.	Example	Format	Name	Unit	Description
0	\$GPDTM	string	\$GPDTM	-	Message ID, DTM protocol header
1	W72	string	LLL	-	Local Datum Code, W84 = WGS84, W72 = WGS72, 999 = user defined
2	-	string	LSD	-	Local Datum Subdivision Code, This field outputs the currently selected Datum as a string (see also note above).
3	0.08	numeric	lat	minutes	Offset in Latitude
4	S	character	NS	-	North/South indicator
5	0.07	numeric	lon	minutes	Offset in Longitude
6	E	character	EW	-	East/West indicator
7	-2.8	numeric	alt	m	Offset in altitude
8	W84	string	RRR	-	Reference Datum Code, W84 = WGS 84. This is the only supported Reference datum.
9	*67	hexadecimal	cs	-	Checksum
10	-	character	<CR><LF>	-	Carriage Return and Line Feed

GPQ

Message	GPQ		
Description	Poll message		
Firmware	Supported on u-blox 5 from firmware version 4.00 up to version 6.02.		
Type	Input Message		
Comment	Polls a standard NMEA message.		
Message Info	<i>ID for CFG-MSG</i>	<i>Number of fields</i>	
	0xF0 0x40	4	

Message Structure:

```
$xxGPQ,sid*cs<CR><LF>
```

Example:

```
$EIGPQ,RMC*3A
```

Field No.	Example	Format	Name	Unit	Description
0	\$EIGPQ	string	\$xxGPQ	-	Message ID, GPQ protocol header, xx = talker identifier
1	RMC	string	sid	-	Sentence identifier
2	*3A	hexadecimal	cs	-	Checksum
3	-	character	<CR><LF>	-	Carriage Return and Line Feed

TXT

Message	TXT		
Description	Text Transmission		
Firmware	Supported on u-blox 5 from firmware version 4.00 up to version 6.02.		
Type	Output Message		
Comment	This message is not configured through CFG-MSG, but instead through CFG-INF. This message outputs various information on the receiver, such as power-up screen, software version etc. This message can be configured using UBX Protocol message CFG-INF		
Message Info	<i>ID for CFG-MSG</i>	<i>Number of fields</i>	
	0xF0 0x41	7	

Message Structure:

```
$GPTXT,xx,yy,zz,ascii data*cs<CR><LF>
```

Example:

```
$GPTXT,01,01,02,u-blox ag - www.u-blox.com*50
```

```
$GPTXT,01,01,02,ANTARIS ATR0620 HW 00000040*67
```

Field No.	Example	Format	Name	Unit	Description
0	\$GPTXT	string	\$GPTXT	-	Message ID, TXT protocol header
1	01	numeric	xx	-	Total number of messages in this transmission, 01..99
2	01	numeric	yy	-	Message number in this transmission, range 01..xx
3	02	numeric	zz	-	Text identifier, u-blox GPS receivers specify the severity of the message with this number. - 00 = ERROR - 01 = WARNING - 02 = NOTICE - 07 = USER
4	www.u-blox.com	string	string	-	Any ASCII text
5	*67	hexadecimal	cs	-	Checksum
6	-	character	<CR><LF>	-	Carriage Return and Line Feed

Proprietary Messages

Proprietary Messages : i.e. Messages defined by u-blox.

UBX,00

Message	UBX,00		
Description	Lat/Long Position Data		
Firmware	Supported on u-blox 5 from firmware version 4.00 up to version 6.02.		
Type	Output Message		
Comment	The output of this message is dependent on the currently selected datum (Default: WGS84) This message contains position solution data. The datum selection may be changed using the message CFG-DAT .		
Message Info	<i>ID for CFG-MSG</i>	<i>Number of fields</i>	
	0xF1 0x00	23	

Message Structure:

```
$PUBX,00,hhmmss.ss, Latitude,N,Longitude,E,AltRef,NavStat,Hacc,Vacc,SOG,COG,Vvel,ageC,HDOP,VDOP,TDOP,
GU,RU,DR,*cs<CR><LF>
```

Example:

```
$PUBX,00,081350.00,4717.113210,N,00833.915187,E,546.589,G3,2.1,2.0,0.007,77.52,0.007,,0.92,1.19,0.7
7,9,0,0*5F
```

Field No.	Example	Format	Name	Unit	Description
0	\$PUBX	string	\$PUBX	-	Message ID, UBX protocol header, proprietary sentence
1	00	numeric	ID	-	Proprietary message identifier: 00
2	081350.00	hhmmss.sss	hhmmss.ss	-	UTC Time, Current time
3	4717.113210	ddmm.mmmm	Latitude	-	Latitude, Degrees + minutes, see Format description
4	N	character	N	-	N/S Indicator, N=north or S=south
5	00833.915187	dddmm.mmmm	Longitude	-	Longitude, Degrees + minutes, see Format description
6	E	character	E	-	E/W indicator, E=east or W=west
7	546.589	numeric	AltRef	m	Altitude above user datum ellipsoid.
8	G3	string	NavStat	-	Navigation Status, See Table below
9	2.1	numeric	Hacc	m	Horizontal accuracy estimate.
10	2.0	numeric	Vacc	m	Vertical accuracy estimate.
11	0.007	numeric	SOG	km/h	Speed over ground
12	77.52	numeric	COG	degrees	Course over ground
13	0.007	numeric	Vvel	m/s	Vertical velocity, positive=downwards
14	-	numeric	ageC	s	Age of most recent DGPS corrections, empty = none available

UBX,00 continued

Field No.	Example	Format	Name	Unit	Description
15	0.92	numeric	HDOP	-	HDOP, Horizontal Dilution of Precision
16	1.19	numeric	VDOP	-	VDOP, Vertical Dilution of Precision
17	0.77	numeric	TDOP	-	TDOP, Time Dilution of Precision
18	9	numeric	GU	-	Number of GPS satellites used in the navigation solution
19	0	numeric	RU	-	Number of GLONASS satellites used in the navigation solution
20	0	numeric	DR	-	DR used
21	*5B	hexadecimal	CS	-	Checksum
22	-	character	<CR><LF>	-	Carriage Return and Line Feed

Table Navigation Status

Navigation Status	Description
NF	No Fix
DR	Dead Reckoning only solution
G2	Stand alone 2D solution
G3	Stand alone 3D solution
D2	Differential 2D solution
D3	Differential 3D solution
RK	Combined GPS + Dead Reckoning solution
TT	Time only solution

UBX,03

Message	UBX,03		
Description	Satellite Status		
Firmware	Supported on u-blox 5 from firmware version 4.00 up to version 6.02.		
Type	Output Message		
Comment	The PUBX,03 message contains satellite status information.		
Message Info	<i>ID for CFG-MSG</i>	<i>Number of fields</i>	
	0xF1 0x03	5 + 6*GT	

Message Structure:

```
$PUBX,03,GT{,SVID,s,AZM,EL,SN,LK},*cs<CR><LF>
```

Example:

```
$PUBX,03,11,23,-,-,45,010,29,-,-,46,013,07,-,-,42,015,08,U,067,31,42,025,10,U,195,33,46,026,18,U,326,08,39,026,17,-,-,32,015,26,U,306,66,48,025,27,U,073,10,36,026,28,U,089,61,46,024,15,-,-,39,014*0D
```

Field No.	Example	Format	Name	Unit	Description
0	\$PUBX	string	\$PUBX	-	Message ID, UBX protocol header, proprietary sentence
1	03	numeric	ID	-	Proprietary message identifier: 03
2	11	numeric	GT	-	Number of GPS satellites tracked
<i>Start of repeated block (GT times)</i>					
3 + 6*N	23	numeric	SVID	-	Satellite PRN number
4 + 6*N	-	character	s	-	Satellite status, see table below
5 + 6*N	-	numeric	AZM	degrees	Satellite azimuth, range 000..359
6 + 6*N	-	numeric	EL	degrees	Satellite elevation, range 00..90
7 + 6*N	45	numeric	SN	dBHz	Signal to noise ratio, range 00..55
8 + 6*N	010	numeric	LK	s	Satellite carrier lock time, range 00..64 0 = code lock only 64 = lock for 64 seconds or more
<i>End of repeated block</i>					
3 + 6*G T	*0D	hexadecimal	cs	-	Checksum
4 + 6*G T	-	character	<CR><LF>	-	Carriage Return and Line Feed

Table Satellite Status

<i>Satellite Status</i>	<i>Description</i>
-	Not used
U	Used in solution
e	Ephemeris available, but not used for navigation

UBX,04

Message	UBX,04		
Description	Time of Day and Clock Information		
Firmware	Supported on u-blox 5 from firmware version 4.00 up to version 6.02.		
Type	Output Message		
Comment	-		
Message Info	<i>ID for CFG-MSG</i>	<i>Number of fields</i>	
	0xF1 0x04	12	

Message Structure:

```
$PUBX,04,hhmmss.ss,ddmmyy,UTC_TOW,UTC_WNO,reserved,Clk_B,Clk_D,PG,*cs<CR><LF>
```

Example:

```
$PUBX,04,073731.00,091202,113851.00,1196,113851.00,1930035,-2660.664,43,*3C
```

Field No.	Example	Format	Name	Unit	Description
0	\$PUBX	string	\$PUBX	-	Message ID, UBX protocol header, proprietary sentence
1	04	numeric	ID	-	Proprietary message identifier: 04
2	073731.00	hhmmss.sss	hhmmss.ss	-	UTC Time, Current time in hour, minutes, seconds
3	091202	ddmmyy	ddmmyy	-	UTC Date, day, month, year format
4	113851.00	numeric	UTC_TOW	s	UTC Time of Week
5	1196	numeric	UTC_WNO	-	UTC week number, continues beyond 1023
6	113851.00	numeric	reserved	-	reserved, for future use
7	1930035	numeric	Clk_B	ns	Receiver clock bias
8	-2660.664	numeric	Clk_D	ns/s	Receiver clock drift
9	43	numeric	PG	ns	Timepulse Granularity, The quantization error of the Timepulse pin
10	*3C	hexadecimal	cs	-	Checksum
11	-	character	<CR><LF>	-	Carriage Return and Line Feed

UBX

Message	UBX		
Description	Poll a PUBX message		
Firmware	Supported on u-blox 5 from firmware version 4.00 up to version 6.02.		
Type	Input Message		
Comment	A PUBX is message is polled by sending the PUBX message without any data fields.		
Message Info	<i>ID for CFG-MSG</i>	<i>Number of fields</i>	
	0xF1 0x40	4	

Message Structure:

```
$PUBX,xx*cs<CR><LF>
```

Example:

```
$PUBX,04*37
```

Field No.	Example	Format	Name	Unit	Description
0	\$PUBX	string	\$PUBX	-	Message ID, UBX protocol header, proprietary sentence
1	04	numeric	MsgID	-	Requested PUBX message identifier
2	*37	hexadecimal	cs	-	Checksum
3	-	character	<CR><LF>	-	Carriage Return and Line Feed

UBX,40

Message	UBX,40		
Description	Set NMEA message output rate		
Firmware	Supported on u-blox 5 from firmware version 4.00 up to version 6.02.		
Type	Set Message		
Comment	Set/Get message rate configuration (s) to/from the receiver. <ul style="list-style-type: none"> Send rate is relative to the event a message is registered on. For example, if the rate of a navigation message is set to 2, the message is sent every second navigation solution. 		
Message Info	<i>ID for CFG-MSG</i>	<i>Number of fields</i>	
	0xF1 0x40	11	

Message Structure:

```
$PUBX,40,msgId,rddc,rus1,rus2,rusb,rspi,reserved*cs<CR><LF>
```

Example:

```
$PUBX,40,GLL,1,0,0,0,0,0*5D
```

Field No.	Example	Format	Name	Unit	Description
0	\$PUBX	string	\$PUBX	-	Message ID, UBX protocol header, proprietary sentence
1	40	numeric	ID	-	Proprietary message identifier
2	GLL	string	MsgId	-	NMEA message identifier
3	1	numeric	rddc	cycles	output rate on DDC - 0 disables that message from being output on this port - 1 means that this message is output every epoch
4	1	numeric	rus1	cycles	output rate on USART 1 - 0 disables that message from being output on this port - 1 means that this message is output every epoch
5	1	numeric	rus2	cycles	output rate on USART 2 - 0 disables that message from being output on this port - 1 means that this message is output every epoch
6	1	numeric	rusb	cycles	output rate on USB - 0 disables that message from being output on this port - 1 means that this message is output every epoch
7	1	numeric	rspi	cycles	output rate on SPI - 0 disables that message from being output on this port - 1 means that this message is output every epoch
8	0	numeric	reserved	-	Reserved, Always fill with 0
9	*5D	hexadecimal	cs	-	Checksum
10	-	character	<CR><LF>	-	Carriage Return and Line Feed

UBX,41

Message	UBX,41		
Description	Set Protocols and Baudrate		
Firmware	Supported on u-blox 5 from firmware version 4.00 up to version 6.02.		
Type	Set Message		
Comment	-		
Message Info	<i>ID for CFG-MSG</i>	<i>Number of fields</i>	
	0xF1 0x41	9	

Message Structure:

```
$PUBX,41,portId,inProto,outProto,baudrate,autobauding*cs<CR><LF>
```

Example:

```
$PUBX,41,1,0007,0003,19200,0*25
```

Field No.	Example	Format	Name	Unit	Description
0	\$PUBX	string	\$PUBX	-	Message ID, UBX protocol header, proprietary sentence
1	41	numeric	ID	-	Proprietary message identifier
2	1	numeric	portID	-	ID of communication port, for a list of port IDs see CFG-PRT .
3	0007	hexadecimal	inProto	-	Input protocol mask. Bitmask, specifying which protocols(s) are allowed for input. For details see corresponding field in CFG-PRT .
4	0003	hexadecimal	outProto	-	Output protocol mask. Bitmask, specifying which protocols(s) are allowed for input. For details see corresponding field in CFG-PRT .
5	19200	numeric	baudrate	bits/s	Baudrate
6	0	numeric	autobauding	-	Autobauding: 1=enable, 0=disable (not supported on u-blox 5, set to 0)
7	*25	hexadecimal	cs	-	Checksum
8	-	character	<CR><LF>	-	Carriage Return and Line Feed

UBX Protocol

UBX Protocol Key Features

u-blox GPS receivers use a u-blox proprietary protocol to transmit GPS data to a host computer using asynchronous RS232 ports. This protocol has the following key features:

- Compact - uses 8 Bit Binary Data.
- Checksum Protected - uses a low-overhead checksum algorithm
- Modular - uses a 2-stage message identifier (Class- and Message ID)

UBX Packet Structure

A basic UBX Packet looks as follows:

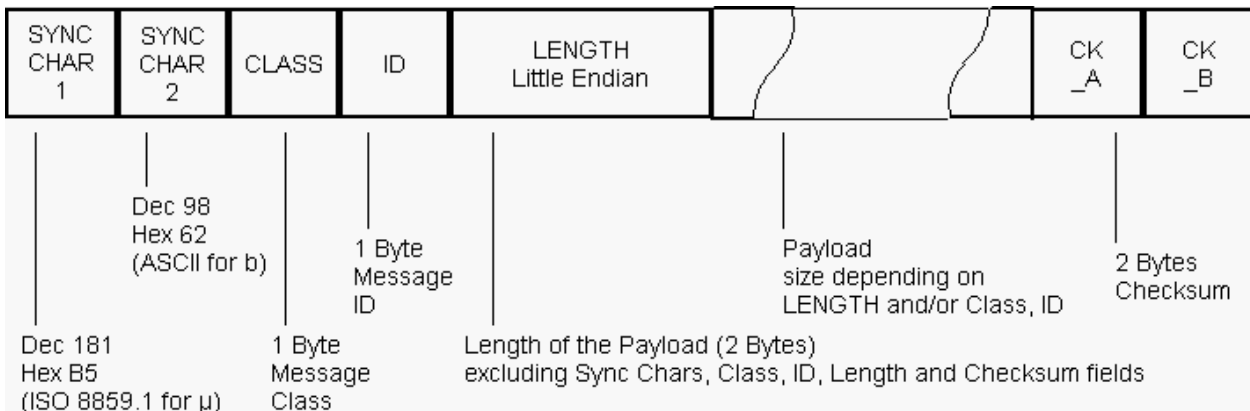

- Every Message starts with 2 Bytes: 0xB5 0x62
- A 1 Byte Class Field follows. The Class defines the basic subset of the message
- A 1 Byte ID Field defines the message that is to follow
- A 2 Byte Length Field is following. Length is defined as being the length of the payload, only. It does not include Sync Chars, Length Field, Class, ID or CRC fields. The number format of the length field is an unsigned 16-Bit integer in Little Endian Format.
- The Payload is a variable length field.
- CK_A and CK_B is a 16 Bit checksum whose calculation is defined below.

UBX Class IDs

A Class is a grouping of messages which are related to each other. The following table gives the short names, description and Class ID Definitions.

Name	Class	Description
NAV	0x01	Navigation Results: Position, Speed, Time, Acc, Heading, DOP, SVs used
RXM	0x02	Receiver Manager Messages: Satellite Status, RTC Status
INF	0x04	Information Messages: Printf-Style Messages, with IDs such as Error, Warning, Notice
ACK	0x05	Ack/Nack Messages: as replies to CFG Input Messages
CFG	0x06	Configuration Input Messages: Set Dynamic Model, Set DOP Mask, Set Baud Rate, etc.
MON	0x0A	Monitoring Messages: Communication Status, CPU Load, Stack Usage, Task Status

UBX Class IDs continued

Name	Class	Description
AID	0x0B	AssistNow Aiding Messages: Ephemeris, Almanac, other A-GPS data input
TIM	0x0D	Timing Messages: Timepulse Output, Timemark Results

All remaining class IDs are reserved.

UBX Payload Definition Rules

Structure Packing

Values are placed in an order that structure packing is not a problem. This means that 2Byte values shall start on offsets which are a multiple of 2, 4-byte values shall start at a multiple of 4, and so on. This can easily be achieved by placing the largest values first in the Message payload (e.g. R8), and ending with the smallest (i.e. one-byters such as U1) values.

Message Naming

Referring to messages is done by adding the class name and a dash in front of the message name. For example, the ECEF-Message is referred to as NAV-POSECEF. Referring to values is done by adding a dash and the name, e.g. NAV-POSECEF-X

Number Formats

All multi-byte values are ordered in Little Endian format, unless otherwise indicated.

All floating point values are transmitted in IEEE754 single or double precision. A technical description of the IEEE754 format can be found in the AnswerBook from the ADS1.x toolkit.

The following table gives information about the various values:

Short	Type	Size (Bytes)	Comment	Min/Max	Resolution
U1	Unsigned Char	1		0..255	1
I1	Signed Char	1	2's complement	-128..127	1
X1	Bitfield	1		n/a	n/a
U2	Unsigned Short	2		0..65535	1
I2	Signed Short	2	2's complement	-32768..32767	1
X2	Bitfield	2		n/a	n/a
U4	Unsigned Long	4		0..4'294'967'295	1
I4	Signed Long	4	2's complement	-2'147'483'648 .. 2'147'483'647	1
X4	Bitfield	4		n/a	n/a
R4	IEEE 754 Single Precision	4		-1*2 ⁺¹²⁷ .. 2 ⁺¹²⁷	~ Value * 2 ⁻²⁴
R8	IEEE 754 Double Precision	8		-1*2 ⁺¹⁰²³ .. 2 ⁺¹⁰²³	~ Value * 2 ⁻⁵³
CH	ASCII / ISO 8859.1 Encoding	1			

UBX Checksum

The checksum is calculated over the packet, starting and including the CLASS field, up until, but excluding, the Checksum Field:

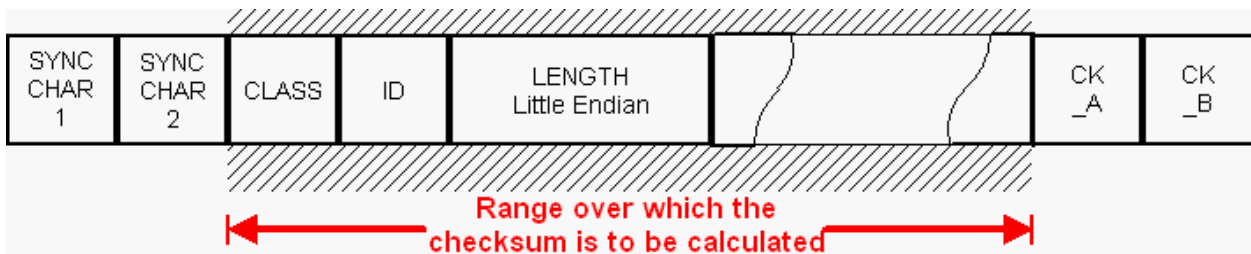

The checksum algorithm used is the 8-Bit Fletcher Algorithm, which is used in the TCP standard ([RFC 1145](#)). This algorithm works as follows:

Buffer[N] contains the data over which the checksum is to be calculated.

The two CK_ values are 8-Bit unsigned integers, only! If implementing with larger-sized integer values, make sure to mask both CK_A and CK_B with 0xFF after both operations in the loop.

```

CK_A = 0, CK_B = 0
For (I=0; I<N; I++)
{
    CK_A = CK_A + Buffer[I]
    CK_B = CK_B + CK_A
}
    
```

After the loop, the two U1 values contain the checksum, transmitted at the end of the packet.

UBX Message Flow

There are certain features associated with the messages being sent back and forth:

Acknowledgement

When messages from the Class CFG are sent to the receiver, the receiver will send an Acknowledge ([ACK-ACK](#)) or a Not Acknowledge ([ACK-NAK](#)) message back to the sender, depending on whether or not the message was processed correctly.

There is no ACK/NAK mechanism for message poll requests outside Class CFG.

Polling Mechanism

All messages that are output by the receiver in a periodic manner (i.e. Messages in Classes MON, NAV and RXM) can also be polled.

There is not a single specific message which polls any other message. The UBX protocol was designed such, that when sending a message with no payload (or just a single parameter which identifies the poll request) the message is polled.

UBX Messages Overview

Page	Mnemonic	Cls/ID	Length	Type	Description
UBX Class ACK				Ack/Nack Messages	
92	ACK-ACK	0x05 0x01	2	Answer	Message Acknowledged
92	ACK-NAK	0x05 0x00	2	Answer	Message Not-Acknowledged
UBX Class AID				AssistNow Aiding Messages	
139	AID-ALM	0x0B 0x30	0	Poll Request	Poll GPS Aiding Almanac Data
140	AID-ALM	0x0B 0x30	1	Poll Request	Poll GPS Aiding Almanac Data for a SV
140	AID-ALM	0x0B 0x30	(8) or (40)	Input/Output Message	GPS Aiding Almanac Input/Output Message
142	AID-ALPSRV	0x0B 0x32	16	Output Message	ALP client requests AlmanacPlus data from server
143	AID-ALPSRV	0x0B 0x32	16 + 1*dataSize	Input Message	ALP server sends AlmanacPlus data to client
144	AID-ALPSRV	0x0B 0x32	8 + 2*size	Output Message	ALP client sends AlmanacPlus data to server.
144	AID-ALP	0x0B 0x50	0 + 2*Variable	Input message	ALP file data transfer to the receiver
145	AID-ALP	0x0B 0x50	1	Input message	Mark end of data transfer
145	AID-ALP	0x0B 0x50	1	Output message	Acknowledges a data transfer
146	AID-ALP	0x0B 0x50	1	Output message	Indicate problems with a data transfer
146	AID-ALP	0x0B 0x50	24	Periodic/Polled	Poll the AlmanacPlus status
147	AID-ALP	0x0B 0x50	24	Periodic/Polled	Poll the AlmanacPlus status
139	AID-DATA	0x0B 0x10	0	Poll	Polls all GPS Initial Aiding Data
141	AID-EPH	0x0B 0x31	0	Poll Request	Poll GPS Aiding Ephemeris Data
141	AID-EPH	0x0B 0x31	1	Poll Request	Poll GPS Aiding Ephemeris Data for a SV
142	AID-EPH	0x0B 0x31	(8) or (104)	Input/Output Message	GPS Aiding Ephemeris Input/Output Message
137	AID-HUI	0x0B 0x02	0	Poll Request	Poll GPS Health, UTC and ionosphere parameters
138	AID-HUI	0x0B 0x02	72	Input/Output Message	GPS Health, UTC and ionosphere parameters
135	AID-INI	0x0B 0x01	0	Poll Request	Poll GPS Initial Aiding Data
136	AID-INI	0x0B 0x01	48	Polled	Aiding position, time, frequency, clock drift
135	AID-REQ	0x0B 0x00	0	Virtual	Sends a poll (AID-DATA) for all GPS Aiding Data
UBX Class CFG				Configuration Input Messages	
112	CFG-ANT	0x06 0x13	0	Poll Request	Poll Antenna Control Settings
113	CFG-ANT	0x06 0x13	4	Get/Set	Get/Set Antenna Control Settings
114	CFG-ANT	0x06 0x13	4	Get/Set	Get/Set Antenna Control Settings
109	CFG-CFG	0x06 0x09	(12) or (13)	Command	Clear, Save and Load configurations
104	CFG-DAT	0x06 0x06	0	Poll Request	Poll Datum Setting
104	CFG-DAT	0x06 0x06	2	Set	Set Standard Datum
105	CFG-DAT	0x06 0x06	44	Set	Set User-defined Datum
105	CFG-DAT	0x06 0x06	52	Get	Get currently selected Datum
110	CFG-FXN	0x06 0x0E	0	Poll Request	Poll FXN configuration
111	CFG-FXN	0x06 0x0E	36	Command	RXM FixNOW configuration.
101	CFG-INF	0x06 0x02	1	Poll Request	Poll INF message configuration for one protocol

UBX Messages Overview continued

Page	Mnemonic	Cls/ID	Length	Type	Description
102	CFG-INF	0x06 0x02	0 + 10*Num	Set/Get	Information message configuration
100	CFG-MSG	0x06 0x01	2	Poll Request	Poll a message configuration
100	CFG-MSG	0x06 0x01	8	Set/Get	Set Message Rate(s)
101	CFG-MSG	0x06 0x01	3	Set/Get	Set Message Rate
122	CFG-NAV5	0x06 0x24	0	Poll Request	Poll Navigation Engine Settings
122	CFG-NAV5	0x06 0x24	36	Get/Set	Get/Set Navigation Engine Settings
120	CFG-NAVX5	0x06 0x23	0	Poll Request	Poll Navigation Engine Expert Settings
121	CFG-NAVX5	0x06 0x23	40	Get/Set	Get/Set Navigation Engine Expert Settings
116	CFG-NMEA	0x06 0x17	0	Poll Request	Poll the NMEA protocol configuration
117	CFG-NMEA	0x06 0x17	4	Set/Get	Set/Get the NMEA protocol configuration
124	CFG-PM	0x06 0x32	24	Set/Get	Power Management configuration
93	CFG-PRT	0x06 0x00	0	Poll Request	Polls the configuration of the used I/O Port
93	CFG-PRT	0x06 0x00	1	Poll Request	Polls the configuration for one I/O Port
94	CFG-PRT	0x06 0x00	20	Get/Set	Get/Set Port Configuration for UART
95	CFG-PRT	0x06 0x00	20	Get/Set	Get/Set Port Configuration for USB Port
97	CFG-PRT	0x06 0x00	20	Get/Set	Get/Set Port Configuration for SPI Port
98	CFG-PRT	0x06 0x00	20	Get/Set	Get/Set Port Configuration for DDC Port
108	CFG-RATE	0x06 0x08	0	Poll Request	Poll Navigation/Measurement Rate Settings
108	CFG-RATE	0x06 0x08	6	Get/Set	Navigation/Measurement Rate Settings
125	CFG-RINV	0x06 0x34	1 + 1*n	Set/Get	Set/Get contents of Remote Inventory
103	CFG-RST	0x06 0x04	4	Command	Reset Receiver / Clear Backup Data Structures
112	CFG-RXM	0x06 0x11	2	Set/Get	RXM configuration
115	CFG-SBAS	0x06 0x16	8	Command	SBAS Configuration
119	CFG-TMODE	0x06 0x1D	0	Poll Request	Poll Time Mode Settings
120	CFG-TMODE	0x06 0x1D	28	Get/Set	Time Mode Settings
106	CFG-TP	0x06 0x07	0	Poll Request	Poll TimePulse Parameters
107	CFG-TP	0x06 0x07	20	Get/Set	Get/Set TimePulse Parameters
118	CFG-USB	0x06 0x1B	0	Poll Request	Poll a USB configuration
118	CFG-USB	0x06 0x1B	108	Get/Set	Get/Set USB Configuration
UBX Class INF				Information Messages	
91	INF-DEBUG	0x04 0x04	0 + 1*variable		ASCII String output, indicating debug output
89	INF-ERROR	0x04 0x00	0 + 1*variable		ASCII String output, indicating an error
90	INF-NOTICE	0x04 0x02	0 + 1*variable		ASCII String output, with informational contents
90	INF-TEST	0x04 0x03	0 + 1*variable		ASCII String output, indicating test output
89	INF-WARNING	0x04 0x01	0 + 1*variable		ASCII String output, indicating a warning
UBX Class MON				Monitoring Messages	
133	MON-HW2	0x0A 0x0B	28	Periodic/Polled	Extended Hardware Status
131	MON-HW	0x0A 0x09	68	Periodic/Polled	Hardware Status

UBX Messages Overview continued

Page	Mnemonic	Cls/ID	Length	Type	Description
132	MON-HW	0x0A 0x09	68	Periodic/Polled	Hardware Status
127	MON-IO	0x0A 0x02	0 + 20*NPRT	Periodic/Polled	I/O Subsystem Status
129	MON-MSGPP	0x0A 0x06	120	Periodic/Polled	Message Parse and Process Status
129	MON-RXBUF	0x0A 0x07	24	Periodic/Polled	Receiver Buffer Status
134	MON-RXR	0x0A 0x21	1	Get	Receiver Status Information
130	MON-TXBUF	0x0A 0x08	28	Periodic/Polled	Transmitter Buffer Status
128	MON-VER	0x0A 0x04	40 + 30*Num	Answer to Poll	Receiver/Software Version
128	MON-VER	0x0A 0x04	70 + 30*Num	Answer to Poll	Receiver/Software/ROM Version
UBX Class NAV				Navigation Results	
76	NAV-CLOCK	0x01 0x22	20	Periodic/Polled	Clock Solution
71	NAV-DOP	0x01 0x04	18	Periodic/Polled	Dilution of precision
69	NAV-POSECEF	0x01 0x01	20	Periodic/Polled	Position Solution in ECEF
69	NAV-POSLLH	0x01 0x02	28	Periodic/Polled	Geodetic Position Solution
79	NAV-SBAS	0x01 0x32	12 + 12*cnt	Periodic/Polled	SBAS Status Data
72	NAV-SOL	0x01 0x06	52	Periodic/Polled	Navigation Solution Information
70	NAV-STATUS	0x01 0x03	16	Periodic/Polled	Receiver Navigation Status
77	NAV-SVINFO	0x01 0x30	8 + 12*numCh	Periodic/Polled	Space Vehicle Information
74	NAV-TIMEGPS	0x01 0x20	16	Periodic/Polled	GPS Time Solution
75	NAV-TIMEUTC	0x01 0x21	20	Periodic/Polled	UTC Time Solution
73	NAV-VELECEF	0x01 0x11	20	Periodic/Polled	Velocity Solution in ECEF
74	NAV-VELNED	0x01 0x12	36	Periodic/Polled	Velocity Solution in NED
UBX Class RXM				Receiver Manager Messages	
84	RXM-ALM	0x02 0x30	0	Poll Request	Poll GPS Constellation Almanach Data
84	RXM-ALM	0x02 0x30	1	Poll Request	Poll GPS Constellation Almanach Data for a SV
85	RXM-ALM	0x02 0x30	(8) or (40)	Poll Answer / Periodic	GPS Aiding Almanach Input/Output Message
85	RXM-EPH	0x02 0x31	0	Poll Request	Poll GPS Constellation Ephemeris Data
86	RXM-EPH	0x02 0x31	1	Poll Request	Poll GPS Constellation Ephemeris Data for a SV
86	RXM-EPH	0x02 0x31	(8) or (104)	Poll Answer / Periodic	GPS Aiding Ephemeris Input/Output Message
87	RXM-PMREQ	0x02 0x41	8	Input	Requests a Power Management task
87	RXM-POSREQ	0x02 0x40	0	Input	Request position fix in Power Management mode
81	RXM-RAW	0x02 0x10	8 + 24*numSV	Periodic/Polled	Raw Measurement Data
82	RXM-SFRB	0x02 0x11	42	Periodic	Subframe Buffer
82	RXM-SVSI	0x02 0x20	8 + 6*numSV	Periodic/Polled	SV Status Info
UBX Class TIM				Timing Messages	
150	TIM-SVIN	0x0D 0x04	28	Periodic/Polled	Survey-in data
149	TIM-TM2	0x0D 0x03	28	Periodic/Polled	Time mark data
148	TIM-TP	0x0D 0x01	16	Periodic/Polled	Timepulse Timedata

NAV (0x01)

Navigation Results: i.e. Position, Speed, Time, Acc, Heading, DOP, SVs used.

Messages in the NAV Class output Navigation Data such as position, altitude and velocity in a number of formats. Additionally, status flags and accuracy figures are output.

NAV-POSECEF (0x01 0x01)

Position Solution in ECEF

Message	NAV-POSECEF				
Description	Position Solution in ECEF				
Firmware	Supported on u-blox 5 from firmware version 4.00 up to version 6.02.				
Type	Periodic/Polled				
Comment	See important comments concerning validity of position given in section Navigation Output Filters. -				
Message Structure	Header	ID	Length (Bytes)	Payload	Checksum
	0xB5 0x62	0x01 0x01	20	see below	CK_A CK_B
Payload Contents:					
Byte Offset	Number Format	Scaling	Name	Unit	Description
0	U4	-	iTOW	ms	GPS Millisecond Time of Week
4	I4	-	ecefX	cm	ECEF X coordinate
8	I4	-	ecefY	cm	ECEF Y coordinate
12	I4	-	ecefZ	cm	ECEF Z coordinate
16	U4	-	pAcc	cm	Position Accuracy Estimate

NAV-POSLLH (0x01 0x02)

Geodetic Position Solution

Message	NAV-POSLLH				
Description	Geodetic Position Solution				
Firmware	Supported on u-blox 5 from firmware version 4.00 up to version 6.02.				
Type	Periodic/Polled				
Comment	See important comments concerning validity of position given in section Navigation Output Filters. This message outputs the Geodetic position in the currently selected Ellipsoid. The default is the WGS84 Ellipsoid, but can be changed with the message CFG-DAT .				
Message Structure	Header	ID	Length (Bytes)	Payload	Checksum
	0xB5 0x62	0x01 0x02	28	see below	CK_A CK_B
Payload Contents:					
Byte Offset	Number Format	Scaling	Name	Unit	Description
0	U4	-	iTOW	ms	GPS Millisecond Time of Week

NAV-POSLH continued

Byte Offset	Number Format	Scaling	Name	Unit	Description
4	I4	1e-7	lon	deg	Longitude
8	I4	1e-7	lat	deg	Latitude
12	I4	-	height	mm	Height above Ellipsoid
16	I4	-	hMSL	mm	Height above mean sea level
20	U4	-	hAcc	mm	Horizontal Accuracy Estimate
24	U4	-	vAcc	mm	Vertical Accuracy Estimate

NAV-STATUS (0x01 0x03)

Receiver Navigation Status

Message	NAV-STATUS				
Description	Receiver Navigation Status				
Firmware	Supported on u-blox 5 from firmware version 4.00 up to version 6.02.				
Type	Periodic/Polled				
Comment	See important comments concerning validity of position and velocity given in section Navigation Output Filters. -				
Message Structure	Header	ID	Length (Bytes)	Payload	Checksum
	0xB5 0x62	0x01 0x03	16	see below	CK_A CK_B
Payload Contents:					
Byte Offset	Number Format	Scaling	Name	Unit	Description
0	U4	-	iTOW	ms	GPS Millisecond Time of Week
4	U1	-	gpsFix	-	GPSfix Type, this value does not qualify a fix as valid and within the limits. See note on flag gpsFixOk below. - 0x00 = no fix - 0x01 = dead reckoning only - 0x02 = 2D-fix - 0x03 = 3D-fix - 0x04 = GPS + dead reckoning combined - 0x05 = Time only fix - 0x06..0xff = reserved
5	X1	-	flags	-	Navigation Status Flags (see graphic below)
6	X1	-	diffStat	-	Differential Status (see graphic below)
7	U1	-	res	-	Reserved
8	U4	-	ttff	-	Time to first fix (millisecond time tag)
12	U4	-	msss	-	Milliseconds since Startup / Reset

Bitfield flags

This Graphic explains the bits of flags

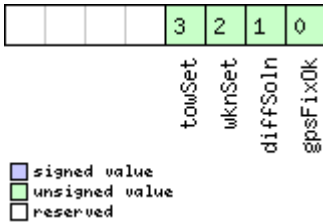

Name	Description
gpsFixOk	position and velocity valid and within DOP and ACC Masks, see also important comments in section Navigation Output Filters .
diffSoln	1 if DGPS used
wknSet	1 if Week Number valid
towSet	1 if Time of Week valid

Bitfield diffStat

This Graphic explains the bits of diffStat

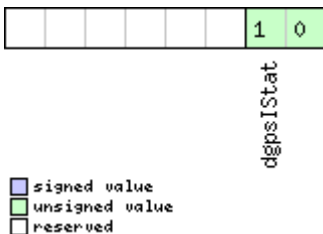

Name	Description
dgpsIStat	DGPS Input Status 00: none 01: PR+PRR Correction 10: PR+PRR+CP Correction 11: High accuracy PR+PRR+CP Correction

NAV-DOP (0x01 0x04)

Dilution of precision

Message	NAV-DOP				
Description	Dilution of precision				
Firmware	Supported on u-blox 5 from firmware version 4.00 up to version 6.02.				
Type	Periodic/Polled				
Comment	<ul style="list-style-type: none"> DOP values are dimensionless. All DOP values are scaled by a factor of 100. If the unit transmits a value of e.g. 156, the DOP value is 1.56. 				
Message Structure	Header	ID	Length (Bytes)	Payload	Checksum
	0xB5 0x62	0x01 0x04	18	see below	CK_A CK_B
Payload Contents:					
Byte Offset	Number Format	Scaling	Name	Unit	Description

NAV-DOP continued

Byte Offset	Number Format	Scaling	Name	Unit	Description
0	U4	-	iTOW	ms	GPS Millisecond Time of Week
4	U2	0.01	gDOP	-	Geometric DOP
6	U2	0.01	pDOP	-	Position DOP
8	U2	0.01	tDOP	-	Time DOP
10	U2	0.01	vDOP	-	Vertical DOP
12	U2	0.01	hDOP	-	Horizontal DOP
14	U2	0.01	nDOP	-	Northing DOP
16	U2	0.01	eDOP	-	Easting DOP

NAV-SOL (0x01 0x06)

Navigation Solution Information

Message	NAV-SOL				
Description	Navigation Solution Information				
Firmware	Supported on u-blox 5 from firmware version 4.00 up to version 6.02.				
Type	Periodic/Polled				
Comment	This message combines Position, velocity and time solution in ECEF, including accuracy figures				
Message Structure	Header	ID	Length (Bytes)	Payload	Checksum
	0xB5 0x62	0x01 0x06	52	see below	CK_A CK_B
Payload Contents:					
Byte Offset	Number Format	Scaling	Name	Unit	Description
0	U4	-	iTOW	ms	GPS Millisecond Time of Week
4	I4	-	fTOW	ns	Fractional Nanoseconds remainder of rounded ms above, range -500000 .. 500000
8	I2	-	week	-	GPS week (GPS time)
10	U1	-	gpsFix	-	GPSfix Type, range 0..4 0x00 = No Fix 0x01 = Dead Reckoning only 0x02 = 2D-Fix 0x03 = 3D-Fix 0x04 = GPS + dead reckoning combined 0x05 = Time only fix 0x06..0xff: reserved
11	X1	-	flags	-	Fix Status Flags (see graphic below)
12	I4	-	ecefX	cm	ECEF X coordinate
16	I4	-	ecefY	cm	ECEF Y coordinate
20	I4	-	ecefZ	cm	ECEF Z coordinate
24	U4	-	pAcc	cm	3D Position Accuracy Estimate
28	I4	-	ecefVX	cm/s	ECEF X velocity
32	I4	-	ecefVY	cm/s	ECEF Y velocity
36	I4	-	ecefVZ	cm/s	ECEF Z velocity

NAV-SOL continued

Byte Offset	Number Format	Scaling	Name	Unit	Description
40	U4	-	sAcc	cm/s	Speed Accuracy Estimate
44	U2	0.01	pDOP	-	Position DOP
46	U1	-	res1	-	reserved
47	U1	-	numSV	-	Number of SVs used in Nav Solution
48	U4	-	res2	-	reserved

Bitfield flags

This Graphic explains the bits of flags

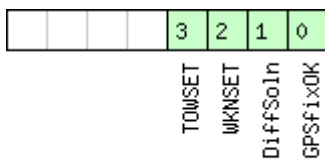

- signed value
- unsigned value
- reserved

Name	Description
GPSfixOK	i.e within DOP & ACC Masks
DiffSoln	1 if DGPS used
WKNSET	1 if Week Number valid
TOWSET	1 if Time of Week valid

NAV-VELECEF (0x01 0x11)

Velocity Solution in ECEF

Message	NAV-VELECEF				
Description	Velocity Solution in ECEF				
Firmware	Supported on u-blox 5 from firmware version 4.00 up to version 6.02.				
Type	Periodic/Polled				
Comment	See important comments concerning validity of velocity given in section Navigation Output Filters.				
	-				
Message Structure	Header	ID	Length (Bytes)	Payload	Checksum
	0xB5 0x62	0x01 0x11	20	see below	CK_A CK_B
Payload Contents:					
Byte Offset	Number Format	Scaling	Name	Unit	Description
0	U4	-	iTOW	ms	GPS Millisecond Time of Week
4	I4	-	ecefVX	cm/s	ECEF X velocity
8	I4	-	ecefVY	cm/s	ECEF Y velocity
12	I4	-	ecefVZ	cm/s	ECEF Z velocity
16	U4	-	sAcc	cm/s	Speed Accuracy Estimate

NAV-VELNED (0x01 0x12)

Velocity Solution in NED

Message	NAV-VELNED				
Description	Velocity Solution in NED				
Firmware	Supported on u-blox 5 from firmware version 4.00 up to version 6.02.				
Type	Periodic/Polled				
Comment	See important comments concerning validity of velocity given in section Navigation Output Filters. -				
Message Structure	Header	ID	Length (Bytes)	Payload	Checksum
	0xB5 0x62	0x01 0x12	36	see below	CK_A CK_B
Payload Contents:					
Byte Offset	Number Format	Scaling	Name	Unit	Description
0	U4	-	iTOW	ms	GPS Millisecond Time of Week
4	I4	-	velN	cm/s	NED north velocity
8	I4	-	velE	cm/s	NED east velocity
12	I4	-	velD	cm/s	NED down velocity
16	U4	-	speed	cm/s	Speed (3-D)
20	U4	-	gSpeed	cm/s	Ground Speed (2-D)
24	I4	1e-5	heading	deg	Heading 2-D
28	U4	-	sAcc	cm/s	Speed Accuracy Estimate
32	U4	1e-5	cAcc	deg	Course / Heading Accuracy Estimate

NAV-TIMEGPS (0x01 0x20)

GPS Time Solution

Message	NAV-TIMEGPS				
Description	GPS Time Solution				
Firmware	Supported on u-blox 5 from firmware version 4.00 up to version 6.02.				
Type	Periodic/Polled				
Comment	-				
Message Structure	Header	ID	Length (Bytes)	Payload	Checksum
	0xB5 0x62	0x01 0x20	16	see below	CK_A CK_B
Payload Contents:					
Byte Offset	Number Format	Scaling	Name	Unit	Description
0	U4	-	iTOW	ms	GPS Millisecond time of Week
4	I4	-	fTOW	ns	Fractional Nanoseconds remainder of rounded ms above, range -500000 .. 500000
8	I2	-	week	-	GPS week (GPS time)
10	I1	-	leapS	s	Leap Seconds (GPS-UTC)

NAV-TIMEGPS continued

Byte Offset	Number Format	Scaling	Name	Unit	Description
11	X1	-	valid	-	Validity Flags (see graphic below)
12	U4	-	tAcc	ns	Time Accuracy Estimate

Bitfield valid

This Graphic explains the bits of valid

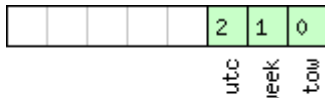

- signed value
- unsigned value
- reserved

Name	Description
tow	1=Valid Time of Week
week	1=Valid Week Number
utc	1=Valid Leap Seconds, i.e. Leap Seconds already known

NAV-TIMEUTC (0x01 0x21)

UTC Time Solution

Message	NAV-TIMEUTC				
Description	UTC Time Solution				
Firmware	Supported on u-blox 5 from firmware version 4.00 up to version 6.02.				
Type	Periodic/Polled				
Comment	-				
Message Structure	Header	ID	Length (Bytes)	Payload	Checksum
	0xB5 0x62	0x01 0x21	20	see below	CK_A CK_B
Payload Contents:					
Byte Offset	Number Format	Scaling	Name	Unit	Description
0	U4	-	iTOW	ms	GPS Millisecond Time of Week
4	U4	-	tAcc	ns	Time Accuracy Estimate
8	I4	-	nano	ns	Nanoseconds of second, range -500000000 .. 500000000 (UTC)
12	U2	-	year	y	Year, range 1999..2099 (UTC)
14	U1	-	month	month	Month, range 1..12 (UTC)
15	U1	-	day	d	Day of Month, range 1..31 (UTC)
16	U1	-	hour	h	Hour of Day, range 0..23 (UTC)
17	U1	-	min	min	Minute of Hour, range 0..59 (UTC)
18	U1	-	sec	s	Seconds of Minute, range 0..59 (UTC)
19	X1	-	valid	-	Validity Flags (see graphic below)

Bitfield valid

This Graphic explains the bits of valid

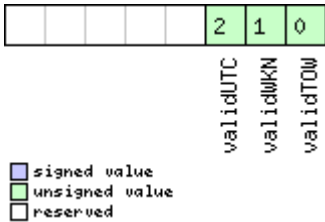

Name	Description
validTOW	1 = Valid Time of Week
validWKN	1 = Valid Week Number
validUTC	1 = Valid UTC (Leap Seconds already known)

NAV-CLOCK (0x01 0x22)

Clock Solution

Message	NAV-CLOCK				
Description	Clock Solution				
Firmware	Supported on u-blox 5 from firmware version 4.00 up to version 6.02.				
Type	Periodic/Polled				
Comment	-				
Message Structure	Header	ID	Length (Bytes)	Payload	Checksum
	0xB5 0x62	0x01 0x22	20	see below	CK_A CK_B
Payload Contents:					
Byte Offset	Number Format	Scaling	Name	Unit	Description
0	U4	-	iTOW	ms	GPS Millisecond Time of week
4	I4	-	c1kB	ns	Clock bias in nanoseconds
8	I4	-	c1kD	ns/s	Clock drift in nanoseconds per second
12	U4	-	tAcc	ns	Time Accuracy Estimate
16	U4	-	fAcc	ps/s	Frequency Accuracy Estimate

NAV-SVINFO (0x01 0x30)

Space Vehicle Information

Message		NAV-SVINFO				
Description		Space Vehicle Information				
Firmware		Supported on u-blox 5 from firmware version 4.00 up to version 6.02.				
Type		Periodic/Polled				
Comment		-				
Message Structure		Header	ID	Length (Bytes)	Payload	Checksum
		0xB5 0x62	0x01 0x30	8 + 12*numCh	see below	CK_A CK_B
Payload Contents:						
Byte Offset	Number Format	Scaling	Name	Unit	Description	
0	U4	-	iTOW	ms	GPS Millisecond time of week	
4	U1	-	numCh	-	Number of channels	
5	X1	-	globalFlags	-	Bitmask (see graphic below)	
6	U2	-	res2	-	Reserved	
Start of repeated block (numCh times)						
8 + 12*N	U1	-	chn	-	Channel number, 255 for SVs not assigned to a channel	
9 + 12*N	U1	-	svid	-	Satellite ID	
10 + 12*N	X1	-	flags	-	Bitmask (see graphic below)	
11 + 12*N	X1	-	quality	-	Bitfield (see graphic below)	
12 + 12*N	U1	-	cno	dBHz	Carrier to Noise Ratio (Signal Strength)	
13 + 12*N	I1	-	elev	deg	Elevation in integer degrees	
14 + 12*N	I2	-	azim	deg	Azimuth in integer degrees	
16 + 12*N	I4	-	prRes	cm	Pseudo range residual in centimetres	
End of repeated block						

Bitfield globalFlags

This Graphic explains the bits of globalFlags

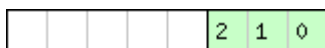

chipGen

- signed value
- unsigned value
- reserved

Name	Description
chipGen	Chip hardware generation 0: Antaris, Antaris 4 1: u-blox 5 2: u-blox 6

Bitfield flags

This Graphic explains the bits of flags

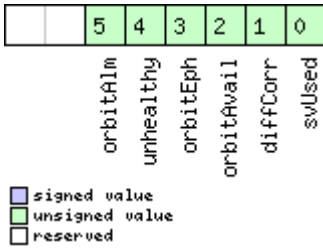

Name	Description
svUsed	SV is used for navigation
diffCorr	Differential correction data is available for this SV
orbitAvail	Orbit information is available for this SV (Ephemeris or Almanach)
orbitEph	Orbit information is Ephemeris
unhealthy	SV is unhealthy / shall not be used
orbitAlm	Orbit information is Almanac Plus

Bitfield quality

This Graphic explains the bits of quality

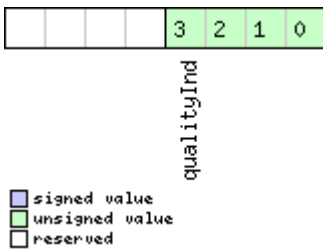

Name	Description
qualityInd	Signal Quality indicator (range 0..7). The following list shows the meaning of the different QI values: 0: This channel is idle 1: Channel is searching 2: Signal aquired 3: Signal detected but unusable 4: Code Lock on Signal 5, 6, 7: Code and Carrier locked

NAV-SBAS (0x01 0x32)

SBAS Status Data

Message	NAV-SBAS				
Description	SBAS Status Data				
Firmware	Supported on u-blox 5 from firmware version 4.00 up to version 6.02.				
Type	Periodic/Polled				
Comment	This message outputs the status of the SBAS sub system				
Message Structure	Header	ID	Length (Bytes)	Payload	Checksum
	0xB5 0x62	0x01 0x32	12 + 12*cnt	see below	CK_A CK_B
Payload Contents:					
Byte Offset	Number Format	Scaling	Name	Unit	Description
0	U4	-	iTOW	ms	GPS Millisecond time of week
4	U1	-	geo	-	PRN Number of the GEO where correction and integrity data is used from
5	U1	-	mode	-	SBAS Mode 0 Disabled 1 Enabled Integrity 3 Enabled Testmode
6	I1	-	sys	-	SBAS System (WAAS/EGNOS/...) -1 Unknown 0 WAAS 1 EGNOS 2 MSAS 16 GPS
7	X1	-	service	-	SBAS Services available (see graphic below)
8	U1	-	cnt	-	Number of SV data following
9	U1[3]	-	res	-	Reserved
Start of repeated block (cnt times)					
12 + 12*N	U1	-	svid	-	SV Id
13 + 12*N	U1	-	flags	-	Flags for this SV
14 + 12*N	U1	-	udre	-	Monitoring status
15 + 12*N	U1	-	svSys	-	System (WAAS/EGNOS/...) same as SYS
16 + 12*N	U1	-	svService	-	Services available same as SERVICE
17 + 12*N	U1	-	res0	-	Reserved
18 + 12*N	I2	-	prc	cm	Pseudo Range correction in [cm]
20 + 12*N	I2	-	res1	-	Reserved
22 + 12*N	I2	-	ic	cm	Ionosphere correction in [cm]
End of repeated block					

Bitfield service

This Graphic explains the bits of service

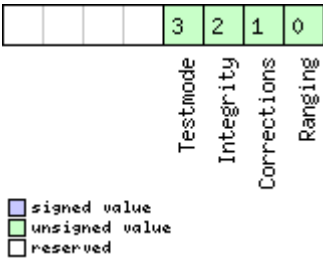

RXM (0x02)

Receiver Manager Messages: i.e. Satellite Status, RTC Status.

Messages in Class RXM output status and result data from the Receiver Manager.

RXM-RAW (0x02 0x10)

Raw Measurement Data

Message	RXM-RAW				
Description	Raw Measurement Data				
Firmware	Supported on u-blox 5 from firmware version 6.00 up to version 6.02 (only available with premium feature raw data).				
Type	Periodic/Polled				
Comment	This message contains all information needed to be able to generate a RINEX file.				
Message Structure	Header	ID	Length (Bytes)	Payload	Checksum
	0xB5 0x62	0x02 0x10	8 + 24*numSV	see below	CK_A CK_B
Payload Contents:					
Byte Offset	Number Format	Scaling	Name	Unit	Description
0	I4	-	iTOW	ms	Measurement integer millisecond GPS time of week (Receiver Time)
4	I2	-	week	weeks	Measurement GPS week number (Receiver Time).
6	U1	-	numSV	-	# of satellites following.
7	U1	-	res1	-	Reserved
Start of repeated block (numSV times)					
8 + 24*N	R8	-	cpMes	cycles	Carrier phase measurement [L1 cycles]
16 + 24*N	R8	-	prMes	m	Pseudorange measurement [m]
24 + 24*N	R4	-	doMes	Hz	Doppler measurement [Hz]
28 + 24*N	U1	-	sv	-	Space Vehicle Number
29 + 24*N	I1	-	mesQI	-	Nav Measurements Quality Indicator: >=4 : PR+DO OK >=5 : PR+DO+CP OK <6 : likely loss of carrier lock in previous interval
30 + 24*N	I1	-	cno	dbHz	Signal strength C/No. (dbHz)
31 + 24*N	U1	-	lli	-	Loss of lock indicator (RINEX definition)
End of repeated block					

RXM-SFRB (0x02 0x11)

Subframe Buffer

Message	RXM-SFRB				
Description	Subframe Buffer				
Firmware	Supported on u-blox 5 from firmware version 6.00 up to version 6.02 (only available with premium feature raw data).				
Type	Periodic				
Comment	<p>The content of one single subframe buffer</p> <p>For GPS satellites, the 10 dwrđ values contain the parity checked subframe data for 10 Words. Each dwrđ has 24 Bits with valid data (Bits 23 to 0). The remaining 8 bits (31 to 24) have an undefined value. The direction within the Word is that the higher order bits are received from the SV first. Example: The Preamble can be found in dwrđ[0], at bit position 23 down to 16. For more details on the data format please refer to the ICD-GPS-200C Interface document.</p> <p>For SBAS satellites, the 250 Bit message block can be found in dwrđ[0] to dwrđ[6] for the first 224 bits. The remaining 26 bits are in dwrđ[7], whereas Bits 25 and 24 are the last two data bits, and Bits 23 down to 0 are the parity bits. For more information on SBAS data format, please refer to RTCA/DO-229C (MOPS), Appendix A.</p>				
Message Structure	Header	ID	Length (Bytes)	Payload	Checksum
	0xB5 0x62	0x02 0x11	42	see below	CK_A CK_B
Payload Contents:					
Byte Offset	Number Format	Scaling	Name	Unit	Description
0	U1	-	chn	-	Channel Number
1	U1	-	svid	-	ID of Satellite transmitting Subframe
2	X4[10]	-	dwrđ	-	Words of Data

RXM-SVSI (0x02 0x20)

SV Status Info

Message	RXM-SVSI				
Description	SV Status Info				
Firmware	Supported on u-blox 5 from firmware version 4.00 up to version 6.02.				
Type	Periodic/Polled				
Comment	Status of the receiver manager knowledge about GPS Orbit Validity				
Message Structure	Header	ID	Length (Bytes)	Payload	Checksum
	0xB5 0x62	0x02 0x20	8 + 6*numSV	see below	CK_A CK_B
Payload Contents:					
Byte Offset	Number Format	Scaling	Name	Unit	Description
0	I4	-	iTOW	ms	Measurement integer millisecond GPS time of week

RXM-SVSI continued

Byte Offset	Number Format	Scaling	Name	Unit	Description
4	I2	-	week	weeks	Measurement GPS week number.
6	U1	-	numVis	-	Number of visible satellites
7	U1	-	numSV	-	Number of per-SV data blocks following
<i>Start of repeated block (numSV times)</i>					
8 + 6*N	U1	-	svid	-	Satellite ID
9 + 6*N	X1	-	svFlag	-	Information Flags (see graphic below)
10 + 6*N	I2	-	azim	-	Azimuth
12 + 6*N	I1	-	elev	-	Elevation
13 + 6*N	X1	-	age	-	Age of Almanac and Ephemeris: (see graphic below)
<i>End of repeated block</i>					

Bitfield svFlag

This Graphic explains the bits of svFlag

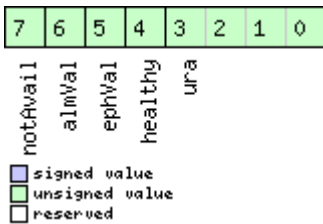

Name	Description
ura	Figure of Merit (URA) range 0..15
healthy	SV healthy flag
ephVal	Ephemeris valid
almVal	Almanac valid
notAvail	SV not available

Bitfield age

This Graphic explains the bits of age

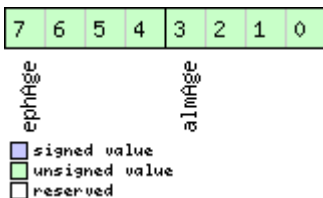

Name	Description
almAge	Age of ALM in days offset by 4 i.e. the reference time may be in the future: $ageOfAlm = (age \& 0x0f) - 4$
ephAge	Age of EPH in hours offset by 4. i.e. the reference time may be in the future: $ageOfEph = ((age \& 0xf0) \gg 4) - 4$

RXM-ALM (0x02 0x30)

Poll GPS Constellation Almanach Data

<i>Message</i>	RXM-ALM				
<i>Description</i>	Poll GPS Constellation Almanach Data				
<i>Firmware</i>	Supported on u-blox 5 from firmware version 6.00 up to version 6.02 (only available with premium feature raw data).				
<i>Type</i>	Poll Request				
<i>Comment</i>	This message has an empty payload! Poll GPS Constellation Data (Almanach) for all 32 SVs by sending this message to the receiver without any payload. The receiver will return 32 messages of type RXM-ALM as defined below.				
<i>Message Structure</i>	<i>Header</i>	<i>ID</i>	<i>Length (Bytes)</i>	<i>Payload</i>	<i>Checksum</i>
	0xB5 0x62	0x02 0x30	0	see below	CK_A CK_B
<i>No payload</i>					

Poll GPS Constellation Almanach Data for a SV

<i>Message</i>	RXM-ALM				
<i>Description</i>	Poll GPS Constellation Almanach Data for a SV				
<i>Firmware</i>	Supported on u-blox 5 from firmware version 6.00 up to version 6.02 (only available with premium feature raw data).				
<i>Type</i>	Poll Request				
<i>Comment</i>	Poll GPS Constellation Data (Almanach) for an SV by sending this message to the receiver. The receiver will return one message of type RXM-ALM as defined below.				
<i>Message Structure</i>	<i>Header</i>	<i>ID</i>	<i>Length (Bytes)</i>	<i>Payload</i>	<i>Checksum</i>
	0xB5 0x62	0x02 0x30	1	see below	CK_A CK_B
<i>Payload Contents:</i>					
<i>Byte Offset</i>	<i>Number Format</i>	<i>Scaling</i>	<i>Name</i>	<i>Unit</i>	<i>Description</i>
0	U1	-	svid	-	SV ID for which the receiver shall return its Almanach Data (Valid Range: 1 .. 32).

GPS Aiding Almanach Input/Output Message

Message	RXM-ALM				
Description	GPS Aiding Almanach Input/Output Message				
Firmware	Supported on u-blox 5 from firmware version 6.00 up to version 6.02 (only available with premium feature raw data).				
Type	Poll Answer / Periodic				
Comment	<p>This message is provided considered obsolete, please use AID-ALM instead!</p> <ul style="list-style-type: none"> If the WEEK Value is 0, DWRD0 to DWRD7 are not sent as the almanach is not available for the given SV. DWORD0 to DWORD7 contain the 8 words following the Hand-Over Word (HOW) from the GPS navigation message, either pages 1 to 24 of sub-frame 5 or pages 2 to 10 of subframe 4. See IS-GPS-200 for a full description of the contents of the Almanach pages. In DWORD0 to DWORD7, the parity bits have been removed, and the 24 bits of data are located in Bits 0 to 23. Bits 24 to 31 shall be ignored. Example: Parameter e (Eccentricity) from Almanach Subframe 4/5, Word 3, Bits 69-84 within the subframe can be found in DWRD0, Bits 15-0 whereas Bit 0 is the LSB. 				
Message Structure	Header	ID	Length (Bytes)	Payload	Checksum
	0xB5 0x62	0x02 0x30	(8) or (40)	see below	CK_A CK_B
Payload Contents:					
Byte Offset	Number Format	Scaling	Name	Unit	Description
0	U4	-	svid	-	SV ID for which this Almanach Data is (Valid Range: 1 .. 32 or 51, 56, 63).
4	U4	-	week	-	Issue Date of Almanach (GPS week number)
Start of optional block					
8	U4[8]	-	dwrđ	-	Almanach Words
End of optional block					

RXM-EPH (0x02 0x31)

Poll GPS Constellation Ephemeris Data

Message	RXM-EPH				
Description	Poll GPS Constellation Ephemeris Data				
Firmware	Supported on u-blox 5 from firmware version 6.00 up to version 6.02 (only available with premium feature raw data).				
Type	Poll Request				
Comment	<p>This message has an empty payload!</p> <p>Poll GPS Constellation Data (Ephemeris) for all 32 SVs by sending this message to the receiver without any payload. The receiver will return 32 messages of type RXM-EPH as defined below.</p>				
Message Structure	Header	ID	Length (Bytes)	Payload	Checksum

Message Structure	0xB5 0x62	0x02 0x31	0	see below	CK_A CK_B
No payload					

Poll GPS Constellation Ephemeris Data for a SV

Message	RXM-EPH				
Description	Poll GPS Constellation Ephemeris Data for a SV				
Firmware	Supported on u-blox 5 from firmware version 6.00 up to version 6.02 (only available with premium feature raw data).				
Type	Poll Request				
Comment	Poll GPS Constellation Data (Ephemeris) for an SV by sending this message to the receiver. The receiver will return one message of type RXM-EPH as defined below.				
Message Structure	Header	ID	Length (Bytes)	Payload	Checksum
	0xB5 0x62	0x02 0x31	1	see below	CK_A CK_B
Payload Contents:					
Byte Offset	Number Format	Scaling	Name	Unit	Description
0	U1	-	svid	-	SV ID for which the receiver shall return its Ephemeris Data (Valid Range: 1 .. 32).

GPS Aiding Ephemeris Input/Output Message

Message	RXM-EPH				
Description	GPS Aiding Ephemeris Input/Output Message				
Firmware	Supported on u-blox 5 from firmware version 6.00 up to version 6.02 (only available with premium feature raw data).				
Type	Poll Answer / Periodic				
Comment	<p>This message is provided considered obsolete, please use AID-EPH instead!</p> <ul style="list-style-type: none"> SF1D0 to SF3D7 is only sent if ephemeris is available for this SV. If not, the payload may be reduced to 8 Bytes, or all bytes are set to zero, indicating that this SV Number does not have valid ephemeris for the moment. SF1D0 to SF3D7 contain the 24 words following the Hand-Over Word (HOW) from the GPS navigation message, subframes 1 to 3. See IS-GPS-200 for a full description of the contents of the Subframes. In SF1D0 to SF3D7, the parity bits have been removed, and the 24 bits of data are located in Bits 0 to 23. Bits 24 to 31 shall be ignored. 				
Message Structure	Header	ID	Length (Bytes)	Payload	Checksum
	0xB5 0x62	0x02 0x31	(8) or (104)	see below	CK_A CK_B
Payload Contents:					
Byte Offset	Number Format	Scaling	Name	Unit	Description
0	U4	-	svid	-	SV ID for which this ephemeris data is (Valid Range: 1 .. 32).
4	U4	-	how	-	Hand-Over Word of first Subframe. This is required if data is sent to the receiver. 0 indicates that no Ephemeris Data is following.

RXM-EPH continued

Byte Offset	Number Format	Scaling	Name	Unit	Description
<i>Start of optional block</i>					
8	U4[8]	-	sf1d	-	Subframe 1 Words 3..10 (SF1D0..SF1D7)
40	U4[8]	-	sf2d	-	Subframe 2 Words 3..10 (SF2D0..SF2D7)
72	U4[8]	-	sf3d	-	Subframe 3 Words 3..10 (SF3D0..SF3D7)
<i>End of optional block</i>					

RXM-POSREQ (0x02 0x40)

Request position fix in Power Management mode

Message	RXM-POSREQ				
Description	Request position fix in Power Management mode				
Firmware	Supported on u-blox 5 from firmware version 6.00 up to version 6.02.				
Type	Input				
Comment	-				
Message Structure	Header	ID	Length (Bytes)	Payload	Checksum
	0xB5 0x62	0x02 0x40	0	see below	CK_A CK_B
No payload					

RXM-PMREQ (0x02 0x41)

Requests a Power Management task

Message	RXM-PMREQ				
Description	Requests a Power Management task				
Firmware	Supported on u-blox 5 from firmware version 6.00 up to version 6.02.				
Type	Input				
Comment	Request of a Power Management related task of the receiver.				
Message Structure	Header	ID	Length (Bytes)	Payload	Checksum
	0xB5 0x62	0x02 0x41	8	see below	CK_A CK_B
<i>Payload Contents:</i>					
Byte Offset	Number Format	Scaling	Name	Unit	Description
0	U4	-	duration	ms	Duration of the requested task, set to zero for infinite duration
4	X4	-	flags	-	task flags (see graphic below)

Bitfield flags

This Graphic explains the bits of flags

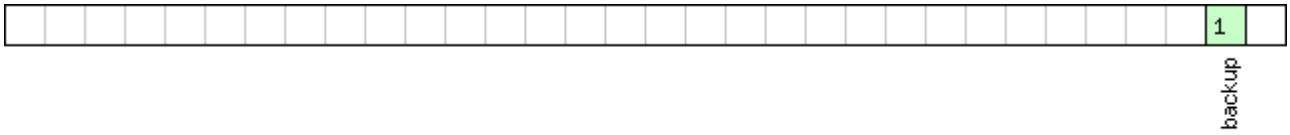

- signed value
- unsigned value
- reserved

Name	Description
backup	The receiver goes into backup mode for a time period defined by duration

INF (0x04)

Information Messages: i.e. Printf-Style Messages, with IDs such as Error, Warning, Notice.

The INF Class is basically an output class that allows the firmware and application code to output strings with a printf-style call. All INF messages have an associated type to indicate the kind of message.

INF-ERROR (0x04 0x00)

ASCII String output, indicating an error

Message	INF-ERROR				
Description	ASCII String output, indicating an error				
Firmware	Supported on u-blox 5 from firmware version 4.00 up to version 6.02.				
Type					
Comment	This message has a variable length payload, representing an ASCII string.				
Message Structure	Header	ID	Length (Bytes)	Payload	Checksum
	0xB5 0x62	0x04 0x00	0 + 1*variable	see below	CK_A CK_B
Payload Contents:					
Byte Offset	Number Format	Scaling	Name	Unit	Description
Start of repeated block (variable times)					
N*1	CH	-	char	-	ASCII Character
End of repeated block					

INF-WARNING (0x04 0x01)

ASCII String output, indicating a warning

Message	INF-WARNING				
Description	ASCII String output, indicating a warning				
Firmware	Supported on u-blox 5 from firmware version 4.00 up to version 6.02.				
Type					
Comment	This message has a variable length payload, representing an ASCII string.				
Message Structure	Header	ID	Length (Bytes)	Payload	Checksum
	0xB5 0x62	0x04 0x01	0 + 1*variable	see below	CK_A CK_B
Payload Contents:					
Byte Offset	Number Format	Scaling	Name	Unit	Description
Start of repeated block (variable times)					
N*1	CH	-	char	-	ASCII Character
End of repeated block					

INF-NOTICE (0x04 0x02)

ASCII String output, with informational contents

Message		INF-NOTICE				
Description		ASCII String output, with informational contents				
Firmware		Supported on u-blox 5 from firmware version 4.00 up to version 6.02.				
Type						
Comment		This message has a variable length payload, representing an ASCII string.				
Message Structure		Header	ID	Length (Bytes)	Payload	Checksum
		0xB5 0x62	0x04 0x02	0 + 1*variable	see below	CK_A CK_B
Payload Contents:						
Byte Offset	Number Format	Scaling	Name	Unit	Description	
Start of repeated block (variable times)						
N*1	CH	-	char	-	ASCII Character	
End of repeated block						

INF-TEST (0x04 0x03)

ASCII String output, indicating test output

Message		INF-TEST				
Description		ASCII String output, indicating test output				
Firmware		Supported on u-blox 5 from firmware version 4.00 up to version 6.02.				
Type						
Comment		This message has a variable length payload, representing an ASCII string.				
Message Structure		Header	ID	Length (Bytes)	Payload	Checksum
		0xB5 0x62	0x04 0x03	0 + 1*variable	see below	CK_A CK_B
Payload Contents:						
Byte Offset	Number Format	Scaling	Name	Unit	Description	
Start of repeated block (variable times)						
N*1	CH	-	char	-	ASCII Character	
End of repeated block						

INF-DEBUG (0x04 0x04)

ASCII String output, indicating debug output

<i>Message</i>	INF-DEBUG				
<i>Description</i>	ASCII String output, indicating debug output				
<i>Firmware</i>	Supported on u-blox 5 from firmware version 4.00 up to version 6.02.				
<i>Type</i>					
<i>Comment</i>	This message has a variable length payload, representing an ASCII string.				
<i>Message Structure</i>	<i>Header</i>	<i>ID</i>	<i>Length (Bytes)</i>	<i>Payload</i>	<i>Checksum</i>
	0xB5 0x62	0x04 0x04	0 + 1*variable	see below	CK_A CK_B
<i>Payload Contents:</i>					
<i>Byte Offset</i>	<i>Number Format</i>	<i>Scaling</i>	<i>Name</i>	<i>Unit</i>	<i>Description</i>
<i>Start of repeated block (variable times)</i>					
N*1	CH	-	char	-	ASCII Character
<i>End of repeated block</i>					

ACK (0x05)

Ack/Nack Messages: i.e. as replies to CFG Input Messages.

Messages in this class are sent as a result of a CFG message being received, decoded and processed by the receiver.

ACK-NAK (0x05 0x00)

Message Not-Acknowledged

<i>Message</i>	ACK-NAK				
<i>Description</i>	Message Not-Acknowledged				
<i>Firmware</i>	Supported on u-blox 5 from firmware version 4.00 up to version 6.02.				
<i>Type</i>	Answer				
<i>Comment</i>	Output upon processing of an input message				
<i>Message Structure</i>	<i>Header</i>	<i>ID</i>	<i>Length (Bytes)</i>	<i>Payload</i>	<i>Checksum</i>
	0xB5 0x62	0x05 0x00	2	see below	CK_A CK_B
<i>Payload Contents:</i>					
<i>Byte Offset</i>	<i>Number Format</i>	<i>Scaling</i>	<i>Name</i>	<i>Unit</i>	<i>Description</i>
0	U1	-	clsID	-	Class ID of the Not-Acknowledged Message
1	U1	-	msgID	-	Message ID of the Not-Acknowledged Message

ACK-ACK (0x05 0x01)

Message Acknowledged

<i>Message</i>	ACK-ACK				
<i>Description</i>	Message Acknowledged				
<i>Firmware</i>	Supported on u-blox 5 from firmware version 4.00 up to version 6.02.				
<i>Type</i>	Answer				
<i>Comment</i>	Output upon processing of an input message				
<i>Message Structure</i>	<i>Header</i>	<i>ID</i>	<i>Length (Bytes)</i>	<i>Payload</i>	<i>Checksum</i>
	0xB5 0x62	0x05 0x01	2	see below	CK_A CK_B
<i>Payload Contents:</i>					
<i>Byte Offset</i>	<i>Number Format</i>	<i>Scaling</i>	<i>Name</i>	<i>Unit</i>	<i>Description</i>
0	U1	-	clsID	-	Class ID of the Acknowledged Message
1	U1	-	msgID	-	Message ID of the Acknowledged Message

CFG (0x06)

Configuration Input Messages: i.e. Set Dynamic Model, Set DOP Mask, Set Baud Rate, etc..

The CFG Class can be used to configure the receiver and read out current configuration values. Any messages in Class CFG sent to the receiver are acknowledged (with Message [ACK-ACK](#)) if processed successfully, and rejected (with Message [ACK-NAK](#)) if processing the message failed.

CFG-PRT (0x06 0x00)

Polls the configuration of the used I/O Port

<i>Message</i>	CFG-PRT				
<i>Description</i>	Polls the configuration of the used I/O Port				
<i>Firmware</i>	Supported on u-blox 5 from firmware version 4.00 up to version 6.02.				
<i>Type</i>	Poll Request				
<i>Comment</i>	Polls the configuration of the I/O Port on which this message is received				
<i>Message Structure</i>	<i>Header</i>	<i>ID</i>	<i>Length (Bytes)</i>	<i>Payload</i>	<i>Checksum</i>
	0xB5 0x62	0x06 0x00	0	see below	CK_A CK_B
<i>No payload</i>					

Polls the configuration for one I/O Port

<i>Message</i>	CFG-PRT				
<i>Description</i>	Polls the configuration for one I/O Port				
<i>Firmware</i>	Supported on u-blox 5 from firmware version 4.00 up to version 6.02.				
<i>Type</i>	Poll Request				
<i>Comment</i>	Sending this message with a port ID as payload results in having the receiver return the configuration for the specified port.				
<i>Message Structure</i>	<i>Header</i>	<i>ID</i>	<i>Length (Bytes)</i>	<i>Payload</i>	<i>Checksum</i>
	0xB5 0x62	0x06 0x00	1	see below	CK_A CK_B
<i>Payload Contents:</i>					
<i>Byte Offset</i>	<i>Number Format</i>	<i>Scaling</i>	<i>Name</i>	<i>Unit</i>	<i>Description</i>
0	U1	-	PortID	-	Port Identifier Number (see the other versions of CFG-PRT for valid values)

Get/Set Port Configuration for UART

Message	CFG-PRT				
Description	Get/Set Port Configuration for UART				
Firmware	Supported on u-blox 5 from firmware version 4.00 up to version 6.02.				
Type	Get/Set				
Comment	Several configurations can be concatenated to one input message. In this case the payload length can be a multiple of the normal length (see the other versions of CFG-PRT). Output messages from the module contain only one configuration unit.				
Message Structure	Header	ID	Length (Bytes)	Payload	Checksum
	0xB5 0x62	0x06 0x00	20	see below	CK_A CK_B
Payload Contents:					
Byte Offset	Number Format	Scaling	Name	Unit	Description
0	U1	-	portID	-	Port Identifier Number (= 1 or 2 for UART ports)
1	U1	-	res0	-	Reserved
2	U2	-	res1	-	Reserved
4	X4	-	mode	-	A bit mask describing the UART mode (see graphic below)
8	U4	-	baudRate	Bits/s	Baudrate in bits/second
12	X2	-	inProtoMask	-	A mask describing which input protocols are active. Each bit of this mask is used for a protocol. Through that, multiple protocols can be defined on a single port. (see graphic below)
14	X2	-	outProtoMask	-	A mask describing which output protocols are active. Each bit of this mask is used for a protocol. Through that, multiple protocols can be defined on a single port. (see graphic below)
16	X2	-	flags	-	Reserved, set to 0
18	U2	-	pad	-	Reserved, set to 0

Bitfield mode

This Graphic explains the bits of mode



- signed value
- unsigned value
- reserved

Name	Description
reserved	Default 1 for compatibility with A4

Bitfield mode Description continued

Name	Description
charLen	Character Length 00 5bit (not supported) 01 6bit (not supported) 10 7bit (supported only with parity) 11 8bit
parity	000 Even Parity 001 Odd Parity 10X No Parity X1X Reserved
nStopBits	Number of Stop Bits 00 1 Stop Bit 01 1.5 Stop Bit 10 2 Stop Bit 11 0.5 Stop Bit

Bitfield inProtoMask

This Graphic explains the bits of inProtoMask

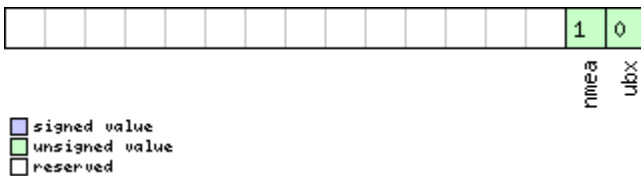

Bitfield outProtoMask

This Graphic explains the bits of outProtoMask

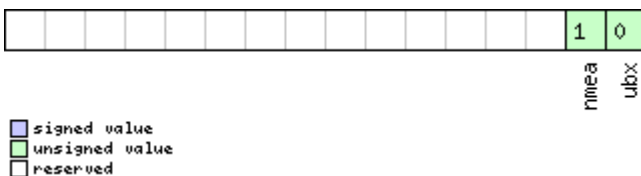

Get/Set Port Configuration for USB Port

Message	CFG-PRT				
Description	Get/Set Port Configuration for USB Port				
Firmware	Supported on u-blox 5 from firmware version 4.00 up to version 6.02.				
Type	Get/Set				
Comment	Several configurations can be concatenated to one input message. In this case the payload length can be a multiple of the normal length (see the other versions of CFG-PRT). Output messages from the module contain only one configuration unit.				
Message Structure	Header	ID	Length (Bytes)	Payload	Checksum
	0xB5 0x62	0x06 0x00	20	see below	CK_A CK_B
Payload Contents:					
Byte Offset	Number Format	Scaling	Name	Unit	Description

CFG-PRT continued

Byte Offset	Number Format	Scaling	Name	Unit	Description
0	U1	-	portID	-	Port Identifier Number (= 3 for USB port)
1	U1	-	res0	-	Reserved
2	U2	-	res1	-	Reserved
4	U4	-	res2	-	Reserved
8	U4	-	res3	-	Reserved
12	X2	-	inProtoMask	-	A mask describing which input protocols are active. Each bit of this mask is used for a protocol. Through that, multiple protocols can be defined on a single port. (see graphic below)
14	X2	-	outProtoMask	-	A mask describing which output protocols are active. Each bit of this mask is used for a protocol. Through that, multiple protocols can be defined on a single port. (see graphic below)
16	X2	-	flags	-	Reserved, set to 0
18	U2	-	pad	-	Reserved, set to 0

Bitfield inProtoMask

This Graphic explains the bits of inProtoMask

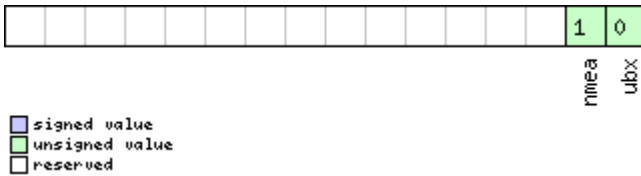

Bitfield outProtoMask

This Graphic explains the bits of outProtoMask

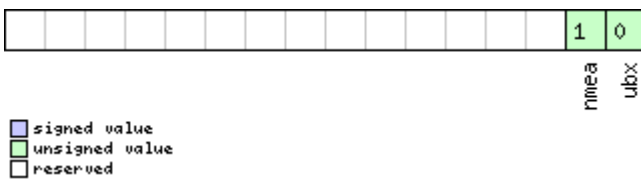

Get/Set Port Configuration for SPI Port

Message	CFG-PRT				
Description	Get/Set Port Configuration for SPI Port				
Firmware	Supported on u-blox 5 from firmware version 4.00 up to version 6.02.				
Type	Get/Set				
Comment	Several configurations can be concatenated to one input message. In this case the payload length can be a multiple of the normal length (see the other versions of CFG-PRT). Output messages from the module contain only one configuration unit.				
Message Structure	Header	ID	Length (Bytes)	Payload	Checksum
	0xB5 0x62	0x06 0x00	20	see below	CK_A CK_B
Payload Contents:					
Byte Offset	Number Format	Scaling	Name	Unit	Description
0	U1	-	portID	-	Port Identifier Number (= 4 for SPI port)
1	U1	-	res0	-	Reserved
2	U2	-	res1	-	Reserved
4	X4	-	mode	-	SPI Mode Flags (see graphic below)
8	U4	-	res2	-	Reserved
12	X2	-	inProtoMask	-	A mask describing which input protocols are active. Each bit of this mask is used for a protocol. Through that, multiple protocols can be defined on a single port. (see graphic below)
14	X2	-	outProtoMask	-	A mask describing which output protocols are active. Each bit of this mask is used for a protocol. Through that, multiple protocols can be defined on a single port. (see graphic below)
16	X2	-	flags	-	Reserved, set to 0
18	U2	-	pad	-	Reserved, set to 0

Bitfield mode

This Graphic explains the bits of mode

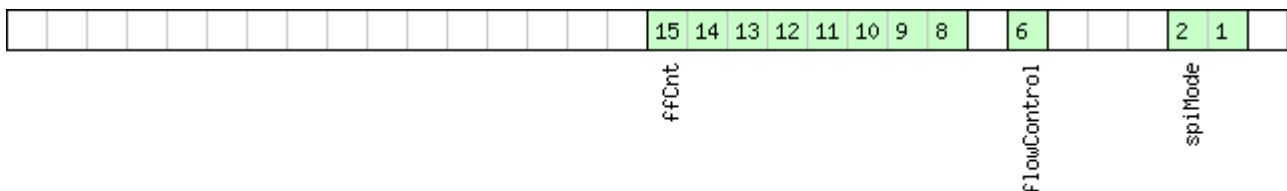

- signed value
- unsigned value
- reserved

Name	Description
spiMode	00 SPI Mode 0: CPOL = 0, CPHA = 0 01 SPI Mode 1: CPOL = 0, CPHA = 1 10 SPI Mode 2: CPOL = 1, CPHA = 0 11 SPI Mode 3: CPOL = 1, CPHA = 1

Bitfield mode Description continued

Name	Description
flowControl	(u-blox 6 only) 0 Flow control disabled 1 Flow control enabled (9-bit mode)
ffCnt	Number of bytes containing 0xFF to receive before switching off reception. Range: 0(mechanism off)-255

Bitfield inProtoMask

This Graphic explains the bits of inProtoMask

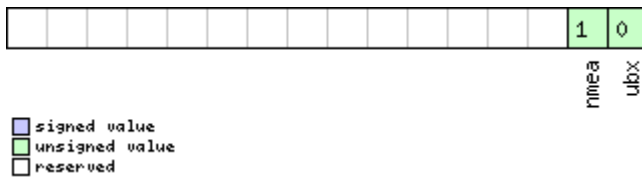

Bitfield outProtoMask

This Graphic explains the bits of outProtoMask

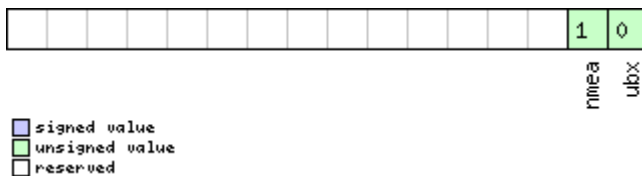

Get/Set Port Configuration for DDC Port

Message	CFG-PRT				
Description	Get/Set Port Configuration for DDC Port				
Firmware	Supported on u-blox 5 from firmware version 4.00 up to version 6.02.				
Type	Get/Set				
Comment	Several configurations can be concatenated to one input message. In this case the payload length can be a multiple of the normal length (see the other versions of CFG-PRT). Output messages from the module contain only one configuration unit.				
Message Structure	Header	ID	Length (Bytes)	Payload	Checksum
	0xB5 0x62	0x06 0x00	20	see below	CK_A CK_B
Payload Contents:					
Byte Offset	Number Format	Scaling	Name	Unit	Description
0	U1	-	portID	-	Port Identifier Number (= 0 for DDC port)
1	U1	-	res0	-	Reserved
2	U2	-	res1	-	Reserved
4	X4	-	mode	-	DDC Mode Flags (see graphic below)
8	U4	-	res2	-	Reserved
12	X2	-	inProtoMask	-	A mask describing which input protocols are active. Each bit of this mask is used for a protocol. Through that, multiple protocols can be defined on a single port. (see graphic below)

CFG-PRT continued

Byte Offset	Number Format	Scaling	Name	Unit	Description
14	X2	-	outProtoMask	-	A mask describing which output protocols are active. Each bit of this mask is used for a protocol. Through that, multiple protocols can be defined on a single port. (see graphic below)
16	X2	-	flags	-	Reserved, set to 0
18	U2	-	pad	-	Reserved, set to 0

Bitfield mode

This Graphic explains the bits of mode

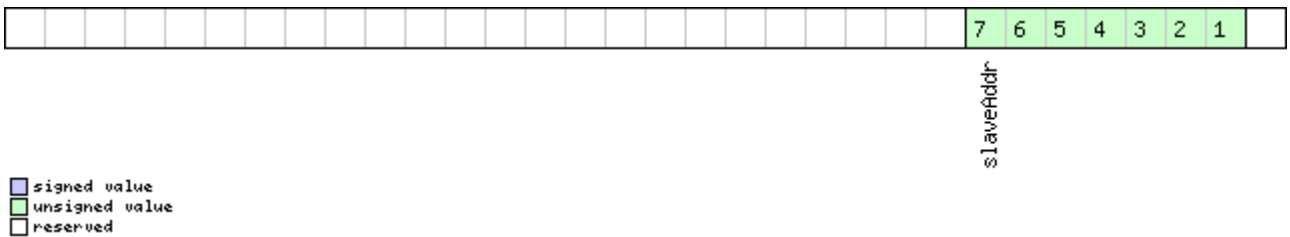

Name	Description
slaveAddr	Slave address Range: 0x07 < slaveAddr < 0x78. Bit 0 must be 0

Bitfield inProtoMask

This Graphic explains the bits of inProtoMask



Bitfield outProtoMask

This Graphic explains the bits of outProtoMask

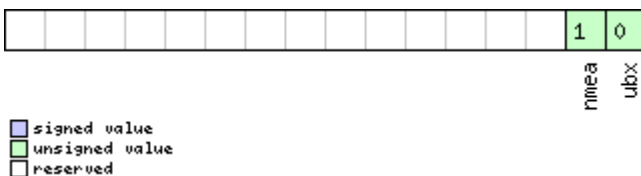

CFG-MSG (0x06 0x01)

Poll a message configuration

<i>Message</i>		CFG-MSG			
<i>Description</i>		Poll a message configuration			
<i>Firmware</i>		Supported on u-blox 5 from firmware version 4.00 up to version 6.02.			
<i>Type</i>		Poll Request			
<i>Comment</i>		-			
<i>Message Structure</i>		<i>Header</i>	<i>ID</i>	<i>Length (Bytes)</i>	<i>Payload</i>
		0xB5 0x62	0x06 0x01	2	see below
<i>Checksum</i>		CK_A CK_B			
<i>Payload Contents:</i>					
<i>Byte Offset</i>	<i>Number Format</i>	<i>Scaling</i>	<i>Name</i>	<i>Unit</i>	<i>Description</i>
0	U1	-	msgClass	-	Message Class
1	U1	-	msgID	-	Message Identifier

Set Message Rate(s)

<i>Message</i>		CFG-MSG			
<i>Description</i>		Set Message Rate(s)			
<i>Firmware</i>		Supported on u-blox 5 from firmware version 4.00 up to version 6.02.			
<i>Type</i>		Set/Get			
<i>Comment</i>		Set/Get message rate configuration (s) to/from the receiver. See also section How to change between protocols . <ul style="list-style-type: none"> Send rate is relative to the event a message is registered on. For example, if the rate of a navigation message is set to 2, the message is sent every second navigation solution. For configuring NMEA messages, the section NMEA Messages Overview describes Class and Identifier numbers used. 			
<i>Message Structure</i>		<i>Header</i>	<i>ID</i>	<i>Length (Bytes)</i>	<i>Payload</i>
		0xB5 0x62	0x06 0x01	8	see below
<i>Checksum</i>		CK_A CK_B			
<i>Payload Contents:</i>					
<i>Byte Offset</i>	<i>Number Format</i>	<i>Scaling</i>	<i>Name</i>	<i>Unit</i>	<i>Description</i>
0	U1	-	msgClass	-	Message Class
1	U1	-	msgID	-	Message Identifier
2	U1[6]	-	rate	-	Send rate on I/O Target (6 Targets)

Set Message Rate

Message	CFG-MSG				
Description	Set Message Rate				
Firmware	Supported on u-blox 5 from firmware version 4.00 up to version 6.02.				
Type	Set/Get				
Comment	Set message rate configuration for the current target. See also section How to change between protocols .				
Message Structure	Header	ID	Length (Bytes)	Payload	Checksum
	0xB5 0x62	0x06 0x01	3	see below	CK_A CK_B
Payload Contents:					
Byte Offset	Number Format	Scaling	Name	Unit	Description
0	U1	-	msgClass	-	Message Class
1	U1	-	msgID	-	Message Identifier
2	U1	-	rate	-	Send rate on current Target

CFG-INF (0x06 0x02)

Poll INF message configuration for one protocol

Message	CFG-INF				
Description	Poll INF message configuration for one protocol				
Firmware	Supported on u-blox 5 from firmware version 4.00 up to version 6.02.				
Type	Poll Request				
Comment	-				
Message Structure	Header	ID	Length (Bytes)	Payload	Checksum
	0xB5 0x62	0x06 0x02	1	see below	CK_A CK_B
Payload Contents:					
Byte Offset	Number Format	Scaling	Name	Unit	Description
0	U1	-	protocolID	-	Protocol Identifier, identifying the output protocol for this Poll Request. The following are valid Protocol Identifiers: - 0: UBX Protocol - 1: NMEA Protocol - 2-255: Reserved

Information message configuration

Message	CFG-INF				
Description	Information message configuration				
Firmware	Supported on u-blox 5 from firmware version 4.00 up to version 6.02.				
Type	Set/Get				
Comment	The value of INFMSG_mask<x> below are that each bit represents one of the INF class messages (Bit 0 for ERROR, Bit 1 for WARNING and so on.). For a complete list, please see the Message Class INF . Several configurations can be concatenated to one input message. In this case the payload length can be a multiple of the normal length. Output messages from the module contain only one configuration unit. Please note that I/O Targets 1 and 2 correspond to serial ports 1 and 2. I/O target 0 is DDC. I/O target 3 is USB. I/O target 4 is SPI. I/O target 5 is reserved for future use.				
Message Structure	Header	ID	Length (Bytes)	Payload	Checksum
	0xB5 0x62	0x06 0x02	0 + 10*Num	see below	CK_A CK_B
Payload Contents:					
Byte Offset	Number Format	Scaling	Name	Unit	Description
Start of repeated block (Num times)					
N*10	U1	-	protocolID	-	Protocol Identifier, identifying for which protocol the configuration is set/get. The following are valid Protocol Identifiers: - 0: UBX Protocol - 1: NMEA Protocol - 2-255: Reserved
1 + 10*N	U1	-	res0	-	Reserved
2 + 10*N	U2	-	res1	-	Reserved
4 + 10*N	X1[6]	-	infMsgMask	-	A bit mask, saying which information messages are enabled on each I/O target (see graphic below)
End of repeated block					

Bitfield infMsgMask

This Graphic explains the bits of infMsgMask

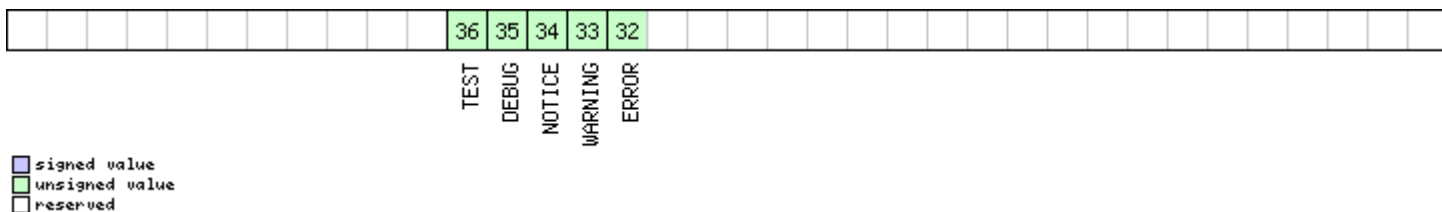

CFG-RST (0x06 0x04)

Reset Receiver / Clear Backup Data Structures

Message		CFG-RST			
Description		Reset Receiver / Clear Backup Data Structures			
Firmware		Supported on u-blox 5 from firmware version 4.00 up to version 6.02.			
Type		Command			
Comment		-			
Message Structure	Header	ID	Length (Bytes)	Payload	Checksum
	0xB5 0x62	0x06 0x04	4	see below	CK_A CK_B
Payload Contents:					
Byte Offset	Number Format	Scaling	Name	Unit	Description
0	X2	-	navBbrMask	-	BBR Sections to clear. The following Special Sets apply: 0x0000 Hotstart 0x0001 Warmstart 0xFFFF Coldstart (see graphic below)
2	U1	-	resetMode	-	Reset Type - 0x00 - Hardware reset (Watchdog) immediately - 0x01 - Controlled Software reset - 0x02 - Controlled Software reset (GPS only) - 0x04 - Hardware reset (Watchdog) after shutdown - 0x08 - Controlled GPS stop - 0x09 - Controlled GPS start
3	U1	-	res	-	Reserved

Bitfield navBbrMask

This Graphic explains the bits of navBbrMask

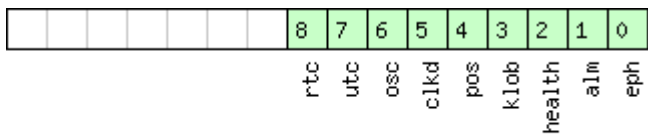

- signed value
- unsigned value
- reserved

Name	Description
eph	Ephemeris
alm	Almanach
health	Health
klob	Klobuchard
pos	Position
clkd	Clock Drift
osc	Oscilator Parameter

Bitfield navBbrMask Description continued

Name	Description
utc	UTC Correction Parameters
rtc	RTC

CFG-DAT (0x06 0x06)

Poll Datum Setting

Message	CFG-DAT				
Description	Poll Datum Setting				
Firmware	Supported on u-blox 5 from firmware version 4.00 up to version 6.02.				
Type	Poll Request				
Comment	Upon sending of this message, the receiver returns CFG-DAT as defined below				
Message Structure	Header	ID	Length (Bytes)	Payload	Checksum
	0xB5 0x62	0x06 0x06	0	see below	CK_A CK_B
No payload					

Set Standard Datum

Message	CFG-DAT				
Description	Set Standard Datum				
Firmware	Supported on u-blox 5 from firmware version 4.00 up to version 6.02.				
Type	Set				
Comment	See section Geodetic Datums in the appendix for a list of supported Datums				
Message Structure	Header	ID	Length (Bytes)	Payload	Checksum
	0xB5 0x62	0x06 0x06	2	see below	CK_A CK_B
Payload Contents:					
Byte Offset	Number Format	Scaling	Name	Unit	Description
0	U2	-	datumNum	-	Datum Number

Set User-defined Datum

Message		CFG-DAT				
Description		Set User-defined Datum				
Firmware		Supported on u-blox 5 from firmware version 4.00 up to version 6.02.				
Type		Set				
Comment		-				
Message Structure		Header	ID	Length (Bytes)	Payload	Checksum
		0xB5 0x62	0x06 0x06	44	see below	CK_A CK_B
Payload Contents:						
Byte Offset	Number Format	Scaling	Name	Unit	Description	
0	R8	-	majA	m	Semi-major Axis (accepted range = 6,300,000.0 to 6,500,000.0 metres).	
8	R8	-	flat	-	1.0 / Flattening (accepted range is 0.0 to 500.0).	
16	R4	-	dX	m	X Axis shift at the origin (accepted range is +/- 5000.0 metres).	
20	R4	-	dY	m	Y Axis shift at the origin (accepted range is +/- 5000.0 metres).	
24	R4	-	dZ	m	Z Axis shift at the origin (accepted range is +/- 5000.0 metres).	
28	R4	-	rotX	s	Rotation about the X Axis (accepted range is +/- 20.0 milli-arc seconds).	
32	R4	-	rotY	s	Rotation about the Y Axis (accepted range is +/- 20.0 milli-arc seconds).	
36	R4	-	rotZ	s	Rotation about the Z Axis (accepted range is +/- 20.0 milli-arc seconds).	
40	R4	-	scale	ppm	Scale change (accepted range is 0.0 to 50.0 parts per million).	

Get currently selected Datum

Message		CFG-DAT				
Description		Get currently selected Datum				
Firmware		Supported on u-blox 5 from firmware version 4.00 up to version 6.02.				
Type		Get				
Comment		The Parameter datumName is only valid, if datumNum is not equal to -1. In case datumNum is -1, the receiver is configured for a custom datum. The parameters from majA to scale are valid for both custom or standard datum formats.				
Message Structure		Header	ID	Length (Bytes)	Payload	Checksum
		0xB5 0x62	0x06 0x06	52	see below	CK_A CK_B
Payload Contents:						
Byte Offset	Number Format	Scaling	Name	Unit	Description	
0	U2	-	datumNum	-	Datum Number according to Geodetic Datums	

CFG-DAT continued

Byte Offset	Number Format	Scaling	Name	Unit	Description
2	CH[6]	-	datumName	-	ASCII String with Datum Mnemonic
8	R8	-	ma jA	m	Semi-major Axis (accepted range = 6,300,000.0 to 6,500,000.0 metres).
16	R8	-	flat	-	1.0 / Flattening (accepted range is 0.0 to 500.0).
24	R4	-	dX	m	X Axis shift at the origin (accepted range is +/- 5000.0 metres).
28	R4	-	dY	m	Y Axis shift at the origin (accepted range is +/- 5000.0 metres).
32	R4	-	dZ	m	Z Axis shift at the origin (accepted range is +/- 5000.0 metres).
36	R4	-	rotX	s	Rotation about the X Axis (accepted range is +/- 20.0 milli-arc seconds).
40	R4	-	rotY	s	Rotation about the Y Axis (accepted range is +/- 20.0 milli-arc seconds).
44	R4	-	rotZ	s	Rotation about the Z Axis (accepted range is +/- 20.0 milli-arc seconds).
48	R4	-	scale	ppm	Scale change (accepted range is 0.0 to 50.0 parts per million).

CFG-TP (0x06 0x07)

Poll TimePulse Parameters

Message	CFG-TP				
Description	Poll TimePulse Parameters				
Firmware	Supported on u-blox 5 from firmware version 4.00 up to version 6.02.				
Type	Poll Request				
Comment	Sending this (empty / no-payload) message to the receiver results in the receiver returning a message of type CFG-TP with a payload as defined below				
Message Structure	Header	ID	Length (Bytes)	Payload	Checksum
	0xB5 0x62	0x06 0x07	0	see below	CK_A CK_B
No payload					

Get/Set TimePulse Parameters

Message	CFG-TP				
Description	Get/Set TimePulse Parameters				
Firmware	Supported on u-blox 5 from firmware version 4.00 up to version 6.02.				
Type	Get/Set				
Comment	-				
Message Structure	Header	ID	Length (Bytes)	Payload	Checksum
	0xB5 0x62	0x06 0x07	20	see below	CK_A CK_B
Payload Contents:					
Byte Offset	Number Format	Scaling	Name	Unit	Description
0	U4	-	interval	us	Time interval for time pulse
4	U4	-	length	us	Length of time pulse
8	I1	-	status	-	Time pulse config setting +1 = positive 0 = off -1 = negative
9	U1	-	timeRef	-	Alignment to reference time: 0 = UTC time, 1 = GPS time 2 = Local time
10	U1	-	flags	-	Bitmask (see graphic below)
11	U1	-	res	-	Reserved
12	I2	-	antennaCableDelay	ns	Antenna Cable Delay
14	I2	-	rfGroupDelay	ns	Receiver RF Group Delay
16	I4	-	userDelay	ns	User Time Function Delay (positive delay results in earlier pulse)

Bitfield flags

This Graphic explains the bits of flags

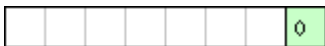

syncMode

- signed value
- unsigned value
- reserved

Name	Description
syncMode	0=Time pulse always synchronized and only available if time is valid 1=Time pulse allowed to be asynchronous and available even when time is not valid

CFG-RATE (0x06 0x08)

Poll Navigation/Measurement Rate Settings

Message	CFG-RATE				
Description	Poll Navigation/Measurement Rate Settings				
Firmware	Supported on u-blox 5 from firmware version 4.00 up to version 6.02.				
Type	Poll Request				
Comment	Sending this (empty / no-payload) message to the receiver results in the receiver returning a message of type CFG-RATE with a payload as defined below				
Message Structure	Header	ID	Length (Bytes)	Payload	Checksum
	0xB5 0x62	0x06 0x08	0	see below	CK_A CK_B
No payload					

Navigation/Measurement Rate Settings

Message	CFG-RATE				
Description	Navigation/Measurement Rate Settings				
Firmware	Supported on u-blox 5 from firmware version 4.00 up to version 6.02.				
Type	Get/Set				
Comment	<p>The u-blox positioning technology supports navigation update rates higher or lower than 1 update per second. The calculation of the navigation solution will always be aligned to the top of a second.</p> <ul style="list-style-type: none"> The update rate has a direct influence on the power consumption. The more fixes that are required, the more CPU power and communication resources are required. For most applications a 1 Hz update rate would be sufficient. 				
Message Structure	Header	ID	Length (Bytes)	Payload	Checksum
	0xB5 0x62	0x06 0x08	6	see below	CK_A CK_B
Payload Contents:					
Byte Offset	Number Format	Scaling	Name	Unit	Description
0	U2	-	measRate	ms	Measurement Rate, GPS measurements are taken every measRate milliseconds
2	U2	-	navRate	cycles	Navigation Rate, in number of measurement cycles. On u-blox 5 and u-blox 6, this parameter cannot be changed, and is always equals 1.
4	U2	-	timeRef	-	Alignment to reference time: 0 = UTC time, 1 = GPS time

CFG-CFG (0x06 0x09)

Clear, Save and Load configurations

Message	CFG-CFG				
Description	Clear, Save and Load configurations				
Firmware	Supported on u-blox 5 from firmware version 4.00 up to version 6.02.				
Type	Command				
Comment	See the Receiver Configuration chapter for a detailed description on how Receiver Configuration should be used. The three masks are made up of individual bits, each bit indicating the sub-section of all configurations on which the corresponding action shall be carried out. Please note that commands can be combined. The sequence of execution is Clear, Save, Load				
Message Structure	Header	ID	Length (Bytes)	Payload	Checksum
	0xB5 0x62	0x06 0x09	(12) or (13)	see below	CK_A CK_B
Payload Contents:					
Byte Offset	Number Format	Scaling	Name	Unit	Description
0	X4	-	clearMask	-	Mask with configuration sub-sections to Clear (=Load Default Configurations to Permanent Configurations in non-volatile memory) (see graphic below)
4	X4	-	saveMask	-	Mask with configuration sub-section to Save (=Save Current Configuration to Non-volatile Memory), see ID description of clearMask
8	X4	-	loadMask	-	Mask with configuration sub-sections to Load (=Load Permanent Configurations from Non-volatile Memory to Current Configurations), see ID description of clearMask
Start of optional block					
12	X1	-	deviceMask	-	Mask which selects the devices for this command. (see graphic below)
End of optional block					

Bitfield clearMask

This Graphic explains the bits of clearMask

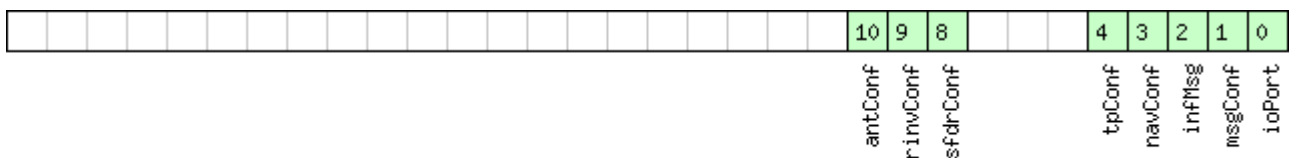

- signed value
- unsigned value
- reserved

Name	Description
ioPort	I/O Port Assignments, Protocols and Baud Rates (See messages UBX-CFG-PRT and UBX-CFG-USB)
msgConf	Message Configuration (See message UBX-CFG-MSG)

Bitfield clearMask Description continued

Name	Description
infMsg	INF Message Configuration (See UBX-CFG-INF)
navConf	NAV Configuration (See UBX-CFG-DAT , UBX-CFG-NAV5 , UBX-CFG-RATE , UBX-CFG-SBAS , UBX-CFG-NMEA , UBX-CFG-TMODE)
tpConf	Timepulse Configuration (See UBX-CFG-TP)
sfdrConf	SFDR Configuration
rinvConf	Remote Inventory Configuration (See UBX-CFG-RINV), only U5R6 and later
antConf	Antenna Configuration (See UBX-CFG-ANT)

Bitfield deviceMask

This Graphic explains the bits of deviceMask

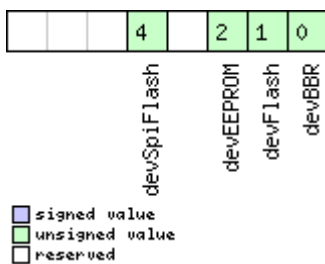

Name	Description
devBBR	device battery backed RAM
devFlash	device Flash
devEEPROM	device EEPROM
devSpiFlash	device SPI Flash (only U5R6 and later)

CFG-FXN (0x06 0x0E)

Poll FXN configuration

Message	CFG-FXN				
Description	Poll FXN configuration				
Firmware	Supported on u-blox 5 from firmware version 6.00 up to version 6.02.				
Type	Poll Request				
Comment	Upon sending of this message, the receiver returns CFG-FXN configuration, as defined below				
Message Structure	Header	ID	Length (Bytes)	Payload	Checksum
	0xB5 0x62	0x06 0x0E	0	see below	CK_A CK_B
No payload					

RXM FixNOW configuration.

Message	CFG-FXN				
Description	RXM FixNOW configuration.				
Firmware	Supported on u-blox 5 from firmware version 6.00 up to version 6.02.				
Type	Command				
Comment	<p>This message is outdated and supported on u-blox 5 only for easier migration from Antaris 4. Please use CFG-PM instead.</p> <p>This message only configures the FixNOW Mode, it does not enable it. To enable FixNOW, please use CFG-RXM.</p>				
Message Structure	Header	ID	Length (Bytes)	Payload	Checksum
	0xB5 0x62	0x06 0x0E	36	see below	CK_A CK_B
Payload Contents:					
Byte Offset	Number Format	Scaling	Name	Unit	Description
0	X4	-	flags	-	FXN configuration flags. Bitmask, Combination of the following flags. (see graphic below)
4	U4	-	tReacq	ms	Time the receiver tries to re-acquire satellites, before going to off state.
8	U4	-	tAcq	ms	Time the receiver tries to acquire satellites, before going to off state.
12	U4	-	tReacqOff	ms	Time the receiver stays in Off-State, if re-acquisition failed.
16	U4	-	tAcqOff	ms	Time the receiver stays in Off-State, if acquisition failed.
20	U4	-	tOn	ms	On time (starts with first fix)
24	U4	-	tOff	ms	Sleep time after normal ontime (actual off time may vary due to data download)
28	U4	-	res	-	Reserved
32	U4	-	baseTow	ms	Base TOW to which t_on/t_sleep are aligned if ABSOLUTE_ALIGN is set

Bitfield flags

This Graphic explains the bits of flags

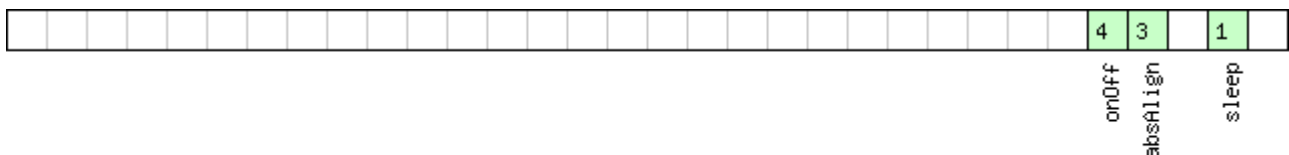

- signed value
- unsigned value
- reserved

Name	Description
sleep	If this bit is set, the unit will enter Sleep Mode. Otherwise, it will enter CPU only mode. In Sleep Mode, the RF section and the CPU are shut down. In CPU only Mode, the RF section is shut down, but the CPU continues to run - this mode is suitable for SCK applications, only.
absAlign	Absolute Alignment (only with on/off time)

Bitfield flags Description continued

Name	Description
onOff	Use on/off time Remaining bits shall never be set.

CFG-RXM (0x06 0x11)

RXM configuration

Message	CFG-RXM				
Description	RXM configuration				
Firmware	Supported on u-blox 5 from firmware version 4.01 up to version 6.02.				
Type	Set/Get				
Comment	For a detailed description see section Power Management .				
Message Structure	Header	ID	Length (Bytes)	Payload	Checksum
	0xB5 0x62	0x06 0x11	2	see below	CK_A CK_B
Payload Contents:					
Byte Offset	Number Format	Scaling	Name	Unit	Description
0	U1	-	reserved	-	reserved
1	U1	-	lpMode	-	Low Power Mode 0: Max. performance mode 1: Power Save Mode (FW 6.00 only) 4: Eco mode 5-255: reserved

CFG-ANT (0x06 0x13)

Poll Antenna Control Settings

Message	CFG-ANT				
Description	Poll Antenna Control Settings				
Firmware	Supported on u-blox 5 from firmware version 4.00 up to version 6.02.				
Type	Poll Request				
Comment	Sending this (empty / no-payload) message to the receiver results in the receiver returning a message of type CFG-ANT with a payload as defined below				
Message Structure	Header	ID	Length (Bytes)	Payload	Checksum
	0xB5 0x62	0x06 0x13	0	see below	CK_A CK_B
No payload					

Get/Set Antenna Control Settings

Message	CFG-ANT				
Description	Get/Set Antenna Control Settings				
Firmware	Supported on u-blox 5 from firmware version 5.00 up to version 6.02.				
Type	Get/Set				
Comment	-				
Message Structure	Header	ID	Length (Bytes)	Payload	Checksum
	0xB5 0x62	0x06 0x13	4	see below	CK_A CK_B
Payload Contents:					
Byte Offset	Number Format	Scaling	Name	Unit	Description
0	X2	-	flags	-	Antenna Flag Mask (see graphic below)
2	X2	-	pins	-	Antenna Pin Configuration (see graphic below)

Bitfield flags

This Graphic explains the bits of flags

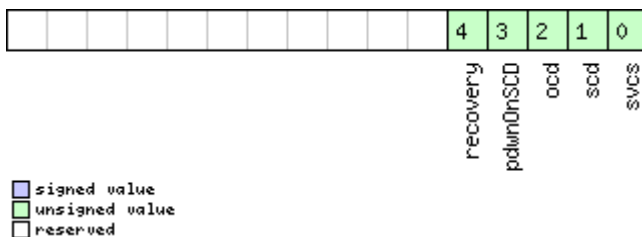

Name	Description
svcs	Enable Antenna Supply Voltage Control Signal
scd	Enable Short Circuit Detection
ocd	Enable Open Circuit Detection
pdwnOnSCD	Power Down Antenna supply if Short Circuit is detected. (only in combination with Bit 1)
recovery	Enable automatic recovery from short state

Bitfield pins

This Graphic explains the bits of pins

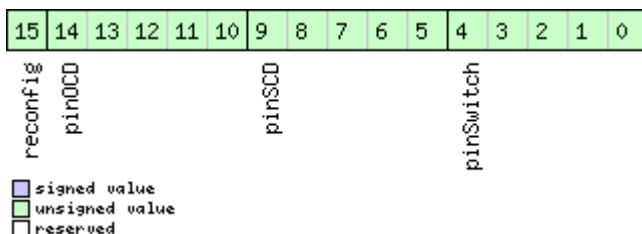

Name	Description
pinSwitch	PIO-Pin used for switching antenna supply (internal to TIM-LP/TIM-LF)
pinSCD	PIO-Pin used for detecting a short in the antenna supply
pinOCD	PIO-Pin used for detecting open/not connected antenna
reconfig	if set to one, and this command is sent to the receiver, the receiver will reconfigure the pins as specified.

Get/Set Antenna Control Settings

Message	CFG-ANT				
Description	Get/Set Antenna Control Settings				
Firmware	Supported on u-blox 5 firmware version 4.00.				
Type	Get/Set				
Comment	-				
Message Structure	Header	ID	Length (Bytes)	Payload	Checksum
	0xB5 0x62	0x06 0x13	4	see below	CK_A CK_B
Payload Contents:					
Byte Offset	Number Format	Scaling	Name	Unit	Description
0	X2	-	flags	-	Antenna Flag Mask (see graphic below)
2	X2	-	pins	-	Antenna Pin Configuration (READ-ONLY) This field is only valid, when data is received from the receiver (Get). If you use this message to configure the antenna control, set all bits of this field to zero. (see graphic below)

Bitfield flags

This Graphic explains the bits of flags

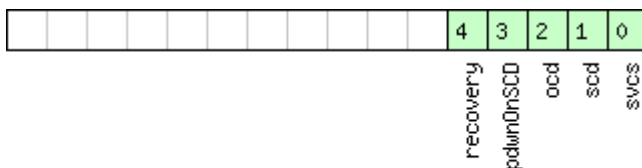

- signed value
- unsigned value
- reserved

Name	Description
svcs	Enable Antenna Supply Voltage Control Signal
scd	Enable Short Circuit Detection
ocd	Enable Open Circuit Detection
pdwnOnSCD	Power Down Antenna supply if Short Circuit is detected. (only in combination with Bit 1)
recovery	Enable automatic recovery from short state

Bitfield pins

This Graphic explains the bits of pins

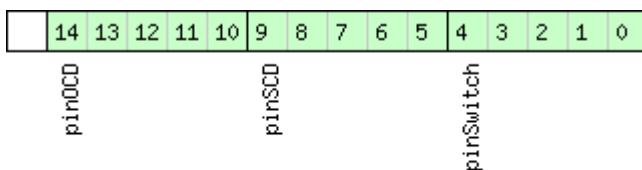

- signed value
- unsigned value
- reserved

Name	Description
pinSwitch	PIO-Pin used for switching antenna supply (internal to TIM-LP/TIM-LF)
pinSCD	PIO-Pin used for detecting a short in the antenna supply

Bitfield pins Description continued

Name	Description
pinOCD	PIO-Pin used for detecting open/not connected antenna

CFG-SBAS (0x06 0x16)

SBAS Configuration

Message	CFG-SBAS				
Description	SBAS Configuration				
Firmware	Supported on u-blox 5 from firmware version 4.00 up to version 6.02.				
Type	Command				
Comment	This message configures the SBAS receiver subsystem (i.e. WAAS, EGNOS, MSAS). See the SBAS Configuration Settings Description for a detailed description of how these settings affect receiver operation.				
Message Structure	Header	ID	Length (Bytes)	Payload	Checksum
	0xB5 0x62	0x06 0x16	8	see below	CK_A CK_B
Payload Contents:					
Byte Offset	Number Format	Scaling	Name	Unit	Description
0	X1	-	mode	-	SBAS Mode (see graphic below)
1	X1	-	usage	-	SBAS Usage (see graphic below)
2	U1	-	maxSBAS	-	Maximum Number of SBAS prioritized tracking channels (valid range: 0 - 3) to use
3	X1	-	scanmode2	-	Continuation of scanmode bitmask below (see graphic below)
4	X4	-	scanmode1	-	Which SBAS PRN numbers to search for (Bitmask) If all Bits are set to zero, auto-scan (i.e. all valid PRNs) are searched. Every bit corresponds to a PRN number (see graphic below)

Bitfield mode

This Graphic explains the bits of mode

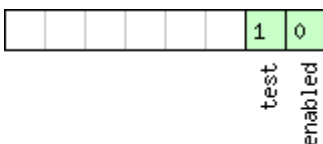

- signed value
- unsigned value
- reserved

Name	Description
enabled	SBAS Enabled (1) / Disabled (0)
test	SBAS Testbed: Use data anyhow (1) / Ignore data when in Test Mode (SBAS Msg 0)

Bitfield usage

This Graphic explains the bits of usage

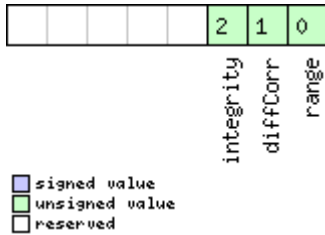

Name	Description
range	Use SBAS GEOs as a ranging source (for navigation)
diffCorr	Use SBAS Differential Corrections
integrity	Use SBAS Integrity Information

Bitfield scanmode2

This Graphic explains the bits of scanmode2

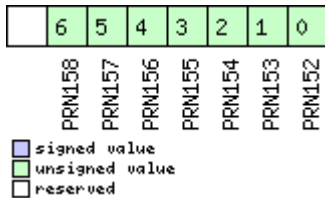

Bitfield scanmode1

This Graphic explains the bits of scanmode1

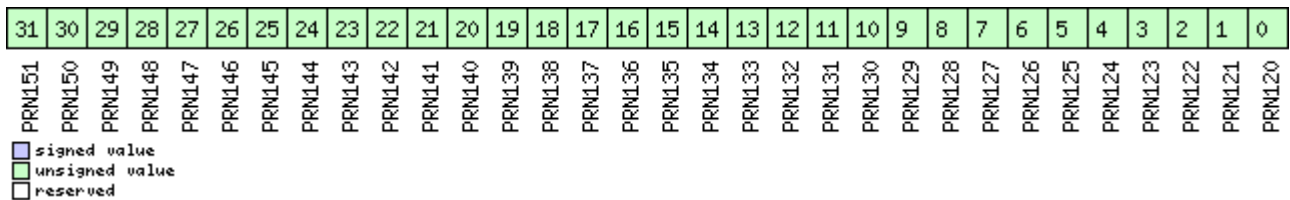

CFG-NMEA (0x06 0x17)

Poll the NMEA protocol configuration

Message	CFG-NMEA				
Description	Poll the NMEA protocol configuration				
Firmware	Supported on u-blox 5 from firmware version 4.00 up to version 6.02.				
Type	Poll Request				
Comment	-				
Message Structure	Header	ID	Length (Bytes)	Payload	Checksum
	0xB5 0x62	0x06 0x17	0	see below	CK_A CK_B
No payload					

Set/Get the NMEA protocol configuration

Message	CFG-NMEA				
Description	Set/Get the NMEA protocol configuration				
Firmware	Supported on u-blox 5 from firmware version 4.00 up to version 6.02.				
Type	Set/Get				
Comment	Set/Get the NMEA protocol configuration. See section NMEA Protocol Configuration for a detailed description of the configuration effects on NMEA output.				
Message Structure	Header	ID	Length (Bytes)	Payload	Checksum
	0xB5 0x62	0x06 0x17	4	see below	CK_A CK_B
Payload Contents:					
Byte Offset	Number Format	Scaling	Name	Unit	Description
0	X1	-	filter	-	filter flags (see graphic below)
1	U1	-	version	-	0x23 = NMEA version 2.3 0x21 = NMEA version 2.1
2	U1	-	numSV	-	Maximum Number of SVs to report in NMEA protocol. This does not affect the receiver's operation. It only limits the number of SVs reported in NMEA mode (this might be needed with older mapping applications which only support 8- or 12-channel receivers).
3	X1	-	flags	-	flags (see graphic below)

Bitfield filter

This Graphic explains the bits of filter

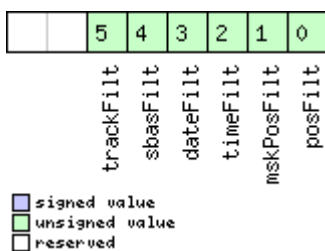

Name	Description
posFilt	disable position filtering
mskPosFilt	disable masked position filtering
timeFilt	disable time filtering
dateFilt	disable date filtering
sbasFilt	enable SBAS filtering
trackFilt	disable track filtering

Bitfield flags

This Graphic explains the bits of flags

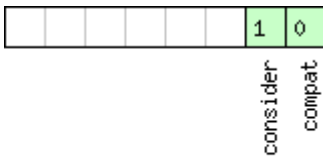

signed value
 unsigned value
 reserved

Name	Description
compat	enable compatibility mode. This might be needed for certain applications when customer's NMEA parser expects a fixed number of digits in position coordinates
consider	enable considering mode.

CFG-USB (0x06 0x1B)

Poll a USB configuration

Message	CFG-USB				
Description	Poll a USB configuration				
Firmware	Supported on u-blox 5 from firmware version 4.00 up to version 6.02.				
Type	Poll Request				
Comment	-				
Message Structure	Header	ID	Length (Bytes)	Payload	Checksum
	0xB5 0x62	0x06 0x1B	0	see below	CK_A CK_B
No payload					

Get/Set USB Configuration

Message	CFG-USB				
Description	Get/Set USB Configuration				
Firmware	Supported on u-blox 5 from firmware version 4.00 up to version 6.02.				
Type	Get/Set				
Comment	-				
Message Structure	Header	ID	Length (Bytes)	Payload	Checksum
	0xB5 0x62	0x06 0x1B	108	see below	CK_A CK_B
Payload Contents:					
Byte Offset	Number Format	Scaling	Name	Unit	Description
0	U2	-	vendorID	-	Vendor ID. This field shall only be set to registered Vendor IDs. Changing this field requires special Host drivers.
2	U2	-	productID	-	Product ID. Changing this field requires special Host drivers.
4	U2	-	reserved1	-	This field is reserved. Always set to 0

CFG-USB continued

Byte Offset	Number Format	Scaling	Name	Unit	Description
6	U2	-	reserved2	-	This field is reserved for special use. Always set to 1
8	U2	-	powerConsumption	-	Power consumed by the device in mA
10	X2	-	flags	-	various configuration flags (see graphic below)
12	CH[32]	-	vendorString	-	String containing the vendor name. 32 ASCII bytes including 0-termination.
44	CH[32]	-	productString	-	String containing the product name. 32 ASCII bytes including 0-termination.
76	CH[32]	-	serialNumber	-	String containing the serial number. 32 ASCII bytes including 0-termination. Changing the String fields requires special Host drivers.

Bitfield flags

This Graphic explains the bits of flags

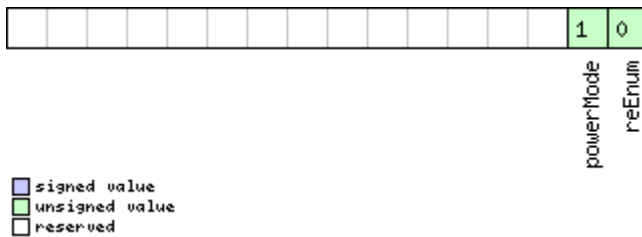

Name	Description
reEnum	force re-enumeration
powerMode	self-powered (1), bus-powered (0)

CFG-TMODE (0x06 0x1D)

Poll Time Mode Settings

Message	CFG-TMODE				
Description	Poll Time Mode Settings				
Firmware	Supported on u-blox 5 from firmware version 5.00 up to version 6.02 (only available with premium feature timing).				
Type	Poll Request				
Comment	This message is available only for timing receivers Sending this (empty / no-payload) message to the receiver results in the receiver returning a message of type CFG-TMODE with a payload as defined below				
Message Structure	Header	ID	Length (Bytes)	Payload	Checksum
	0xB5 0x62	0x06 0x1D	0	see below	CK_A CK_B
No payload					

Time Mode Settings

Message	CFG-TMODE				
Description	Time Mode Settings				
Firmware	Supported on u-blox 5 from firmware version 5.00 up to version 6.02 (only available with premium feature timing).				
Type	Get/Set				
Comment	This message is available only for timing receivers See the Time Mode Description for details.				
Message Structure	Header	ID	Length (Bytes)	Payload	Checksum
	0xB5 0x62	0x06 0x1D	28	see below	CK_A CK_B
Payload Contents:					
Byte Offset	Number Format	Scaling	Name	Unit	Description
0	U4	-	timeMode	-	Time Transfer Mode: 0 Disabled 1 Survey In 2 Fixed Mode (true position information required) 3-255 Reserved
4	I4	-	fixedPosX	cm	Fixed Position ECEF X coordinate
8	I4	-	fixedPosY	cm	Fixed Position ECEF Y coordinate
12	I4	-	fixedPosZ	cm	Fixed Position ECEF Z coordinate
16	U4	-	fixedPosVar	mm ²	Fixed position 3D variance
20	U4	-	svinMinDur	s	Survey-in minimum duration
24	U4	-	svinVarLimit	mm ²	Survey-in position variance limit

CFG-NAVX5 (0x06 0x23)

Poll Navigation Engine Expert Settings

Message	CFG-NAVX5				
Description	Poll Navigation Engine Expert Settings				
Firmware	Supported on u-blox 5 from firmware version 4.00 up to version 6.02.				
Type	Poll Request				
Comment	Sending this (empty / no-payload) message to the receiver results in the receiver returning a message of type CFG-NAVX5 with a payload as defined below.				
Message Structure	Header	ID	Length (Bytes)	Payload	Checksum
	0xB5 0x62	0x06 0x23	0	see below	CK_A CK_B
No payload					

Get/Set Navigation Engine Expert Settings

Message	CFG-NAVX5				
Description	Get/Set Navigation Engine Expert Settings				
Firmware	Supported on u-blox 5 from firmware version 4.00 up to version 6.02.				
Type	Get/Set				
Comment	-				
Message Structure	Header	ID	Length (Bytes)	Payload	Checksum
	0xB5 0x62	0x06 0x23	40	see below	CK_A CK_B
Payload Contents:					
Byte Offset	Number Format	Scaling	Name	Unit	Description
0	U2	-	version	-	Message version. Current version is 0.
2	X2	-	mask1	-	First Parameters Bitmask. Only the flagged parameters will be applied, unused bits must be set to 0. (see graphic below)
4	X4	-	mask2	-	Second Parameters Bitmask. Currently unused, must be set to 0.
8	U1	-	res1	-	reserved, set to 0
9	U1	-	res2	-	reserved, set to 0
10	U1	-	minSVs	#SVs	Minimum number of satellites for navigation
11	U1	-	maxSVs	#SVs	Maximum number of satellites for navigation
12	U1	-	minCNO	dbHz	Minimum satellite signal level for navigation
13	U1	-	res3	-	reserved, set to 0
14	U1	-	iniFix3D	-	Initial Fix must be 3D flag (0=false/1=true)
15	U1	-	res4	-	reserved, set to 0
16	U1	-	res5	-	reserved, set to 0
17	U1	-	res6	-	reserved, set to 0
18	U2	-	wknRollover	-	GPS week rollover number; GPS week numbers will be set correctly from this week up to 1024 weeks after this week. Setting this to 0 reverts to firmware default.
20	U4	-	res7	-	reserved, set to 0
24	U4	-	res8	-	reserved, set to 0
28	U4	-	res9	-	reserved, set to 0
32	U4	-	res10	-	reserved, set to 0
36	U4	-	res11	-	reserved, set to 0

Bitfield mask1

This Graphic explains the bits of mask1

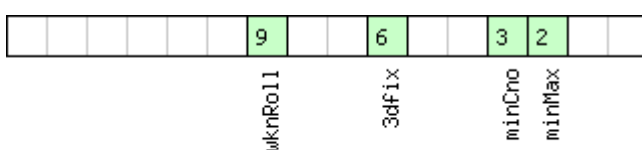

signed value
 unsigned value
 reserved

Bitfield mask1 Description continued

Name	Description
<i>Name</i>	<i>Description</i>
minMax	Apply min/max SVs settings
minCno	Apply minimum C/N0 setting
3dfix	Apply initial 3D fix settings
wknRoll	Apply GPS weeknumber rollover settings

CFG-NAV5 (0x06 0x24)

Poll Navigation Engine Settings

Message	CFG-NAV5				
Description	Poll Navigation Engine Settings				
Firmware	Supported on u-blox 5 from firmware version 4.00 up to version 6.02.				
Type	Poll Request				
Comment	Sending this (empty / no-payload) message to the receiver results in the receiver returning a message of type CFG-NAV5 with a payload as defined below.				
Message Structure	Header	ID	Length (Bytes)	Payload	Checksum
	0xB5 0x62	0x06 0x24	0	see below	CK_A CK_B
No payload					

Get/Set Navigation Engine Settings

Message	CFG-NAV5				
Description	Get/Set Navigation Engine Settings				
Firmware	Supported on u-blox 5 from firmware version 4.00 up to version 6.02.				
Type	Get/Set				
Comment	See the Navigation Configuration Settings Description for a detailed description of how these settings affect receiver operation.				
Message Structure	Header	ID	Length (Bytes)	Payload	Checksum
	0xB5 0x62	0x06 0x24	36	see below	CK_A CK_B
Payload Contents:					
Byte Offset	Number Format	Scaling	Name	Unit	Description
0	X2	-	mask	-	Parameters Bitmask. Only the masked parameters will be applied. (see graphic below)
2	U1	-	dynModel	-	Dynamic Platform model: - 0 Portable - 2 Stationary - 3 Pedestrian - 4 Automotive - 5 Sea - 6 Airborne with <1g Acceleration - 7 Airborne with <2g Acceleration - 8 Airborne with <4g Acceleration

CFG-NAV5 continued

Byte Offset	Number Format	Scaling	Name	Unit	Description
3	U1	-	fixMode	-	Position Fixing Mode. - 1: 2D only - 2: 3D only - 3: Auto 2D/3D
4	I4	0.01	fixedAlt	m	Fixed altitude (mean sea level) for 2D fix mode.
8	U4	0.0001	fixedAltVar	m ²	Fixed altitude variance for 2D mode.
12	I1	-	minElev	deg	Minimum Elevation for a GNSS satellite to be used in NAV
13	U1	-	drLimit	s	Maximum time to perform dead reckoning (linear extrapolation) in case of GPS signal loss
14	U2	0.1	pDop	-	Position DOP Mask to use
16	U2	0.1	tDop	-	Time DOP Mask to use
18	U2	-	pAcc	m	Position Accuracy Mask
20	U2	-	tAcc	m	Time Accuracy Mask
22	U1	-	staticHoldThreshold	cm/s	Static hold threshold
23	U1	-	res1	-	reserved, set to 0
24	U4	-	res2	-	reserved, set to 0
28	U4	-	res3	-	reserved, set to 0
32	U4	-	res4	-	reserved, set to 0

Bitfield mask

This Graphic explains the bits of mask

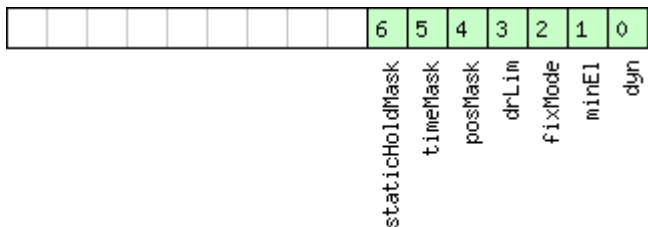

- signed value
- unsigned value
- reserved

Name	Description
dyn	Apply dynamic model settings
minElev	Apply minimum elevation settings
fixMode	Apply fix mode settings
drLim	Apply DR limit settings
posMask	Apply position mask settings
timeMask	Apply time mask settings
staticHoldMask	Apply static hold settings

CFG-PM (0x06 0x32)

Power Management configuration

Message		CFG-PM			
Description		Power Management configuration			
Firmware		Supported on u-blox 5 from firmware version 6.00 up to version 6.02.			
Type		Set/Get			
Comment		-			
Message Structure	Header	ID	Length (Bytes)	Payload	Checksum
	0xB5 0x62	0x06 0x32	24	see below	CK_A CK_B
Payload Contents:					
Byte Offset	Number Format	Scaling	Name	Unit	Description
0	U1	-	version	-	Message version (currently 0)
1	U1	-	res1	-	Reserved
2	U1	-	res2	-	Reserved
3	U1	-	res3	-	Reserved
4	X4	-	flags	-	LPM configuration flags (see graphic below)
8	U4	-	updatePeriod	ms	Position update period. If set to 0, the receiver will never retry a fix
12	U4	-	searchPeriod	ms	Acquisition retry period. If set to 0, the receiver will never retry a startup
16	U4	-	gridOffset	ms	Grid offset relative to GPS start of week
20	U2	-	onTime	s	on time after first successful fix
22	U2	-	minAcqTime	s	minimal search time

Bitfield flags

This Graphic explains the bits of flags

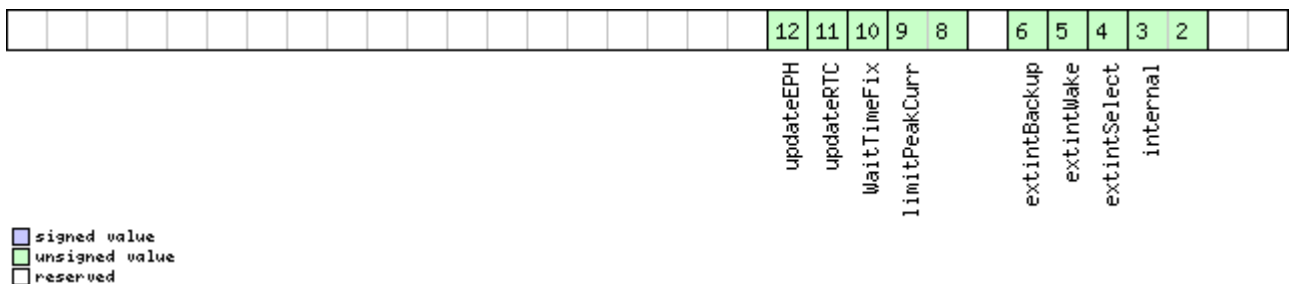

Name	Description
internal	Internal Flag: Must be set to '01'
extintSelect	EXTINT Pin Select 0 EXTINT0 1 EXTINT1
extintWake	EXTINT Pin Control 0 disabled 1 enabled, keep receiver awake as long as selected EXTINT pin is 'high'

Bitfield flags Description continued

Name	Description
extintBackup	EXTINT Pin Control 0 disabled 1 enabled, force receiver into BACKUP mode when selected EXTINT pin is 'low'
limitPeakCurr	Limit Peak Current 00 disabled 01 enabled, peak current is limited 10 reserved 11 reserved
waitTimeFix	Wait for Timefix 0 wait for normal Fix ok, before starting on-time 1 wait for time fix ok, before starting on-time
updateRTC	Update Real Time Clock 0 Do not wake-up to update RTC. RTC is updated during normal on-time. 1 Update RTC. The receiver adds extra wake-up cycles to update the RTC.
updateEPH	Update Ephemeris 0 Do not wake-up to update Ephemeris data 1 Update Ephemeris. The receiver adds extra wake-up cycles to update the Ephemeris data

CFG-RINV (0x06 0x34)

Set/Get contents of Remote Inventory

Message	CFG-RINV				
Description	Set/Get contents of Remote Inventory				
Firmware	Supported on u-blox 5 from firmware version 6.00 up to version 6.02.				
Type	Set/Get				
Comment	If n is greater than 30, the excess bytes are discarded. In future firmware versions, this limit may change.				
Message Structure	Header	ID	Length (Bytes)	Payload	Checksum
	0xB5 0x62	0x06 0x34	1 + 1*n	see below	CK_A CK_B
Payload Contents:					
Byte Offset	Number Format	Scaling	Name	Unit	Description
0	X1	-	flags	-	Flags (see graphic below)
Start of repeated block (n times)					
1 + 1*N	U1	-	data	-	Data to store/stored in Remote Inventory
End of repeated block					

Bitfield flags

This Graphic explains the bits of flags

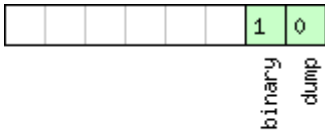

- signed value
- unsigned value
- reserved

Name	Description
dump	Dump data at startup. Does not work if flag binary is set.
binary	Data is binary

MON (0x0A)

Monitoring Messages: i.e. Communication Status, CPU Load, Stack Usage, Task Status.

Messages in this class are sent to report GPS receiver status, such as CPU load, stack usage, I/O subsystem statistics etc.

MON-IO (0x0A 0x02)

I/O Subsystem Status

Message	MON-IO				
Description	I/O Subsystem Status				
Firmware	Supported on u-blox 5 from firmware version 4.00 up to version 6.02.				
Type	Periodic/Polled				
Comment	The size of the message is determined by the NPRT number of ports the receiver supports, i. e. on ANTARIS this is always 4, on u-blox 5 the number of ports is 6.				
Message Structure	Header	ID	Length (Bytes)	Payload	Checksum
	0xB5 0x62	0x0A 0x02	0 + 20*NPRT	see below	CK_A CK_B
Payload Contents:					
Byte Offset	Number Format	Scaling	Name	Unit	Description
Start of repeated block (NPRT times)					
N*20	U4	-	rxBytes	bytes	Number of bytes ever received
4 + 20*N	U4	-	txBytes	bytes	Number of bytes ever sent
8 + 20*N	U2	-	parityErrs	-	Number of 100ms timeslots with parity errors
10 + 20*N	U2	-	framingErrs	-	Number of 100ms timeslots with framing errors
12 + 20*N	U2	-	overrunErrs	-	Number of 100ms timeslots with overrun errors
14 + 20*N	U2	-	breakCond	-	Number of 100ms timeslots with break conditions
16 + 20*N	U1	-	rxBusy	-	Flag is receiver is busy
17 + 20*N	U1	-	txBusy	-	Flag is transmitter is busy
18 + 20*N	U2	-	res	-	reserved
End of repeated block					

MON-VER (0x0A 0x04)

Receiver/Software Version

Message		MON-VER				
Description		Receiver/Software Version				
Firmware		Supported on u-blox 5 from firmware version 4.00 up to version 5.00.				
Type		Answer to Poll				
Comment		-				
Message Structure		Header	ID	Length (Bytes)	Payload	Checksum
		0xB5 0x62	0x0A 0x04	40 + 30*Num	see below	CK_A CK_B
Payload Contents:						
Byte Offset	Number Format	Scaling	Name	Unit	Description	
0	CH[30]	-	swVersion	-	Zero-terminated Software Version String	
30	CH[10]	-	hwVersion	-	Zero-terminated Hardware Version String	
Start of repeated block (Num times)						
40 + 30*N	CH[30]	-	extension	-	Installed Extension Package Version	
End of repeated block						

Receiver/Software/ROM Version

Message		MON-VER				
Description		Receiver/Software/ROM Version				
Firmware		Supported on u-blox 5 from firmware version 6.00 up to version 6.02.				
Type		Answer to Poll				
Comment		-				
Message Structure		Header	ID	Length (Bytes)	Payload	Checksum
		0xB5 0x62	0x0A 0x04	70 + 30*Num	see below	CK_A CK_B
Payload Contents:						
Byte Offset	Number Format	Scaling	Name	Unit	Description	
0	CH[30]	-	swVersion	-	Zero-terminated Software Version String	
30	CH[10]	-	hwVersion	-	Zero-terminated Hardware Version String	
40	CH[30]	-	romVersion	-	Zero-terminated ROM Version String	
Start of repeated block (Num times)						
70 + 30*N	CH[30]	-	extension	-	Installed Extension Package Version	
End of repeated block						

MON-MSGPP (0x0A 0x06)

Message Parse and Process Status

<i>Message</i>	MON-MSGPP				
<i>Description</i>	Message Parse and Process Status				
<i>Firmware</i>	Supported on u-blox 5 from firmware version 4.00 up to version 6.02.				
<i>Type</i>	Periodic/Polled				
<i>Comment</i>	-				
<i>Message Structure</i>	<i>Header</i>	<i>ID</i>	<i>Length (Bytes)</i>	<i>Payload</i>	<i>Checksum</i>
	0xB5 0x62	0x0A 0x06	120	see below	CK_A CK_B
<i>Payload Contents:</i>					
<i>Byte Offset</i>	<i>Number Format</i>	<i>Scaling</i>	<i>Name</i>	<i>Unit</i>	<i>Description</i>
0	U2[8]	-	msg1	msgs	Number of successfully parsed messages for each protocol on target0
16	U2[8]	-	msg2	msgs	Number of successfully parsed messages for each protocol on target1
32	U2[8]	-	msg3	msgs	Number of successfully parsed messages for each protocol on target2
48	U2[8]	-	msg4	msgs	Number of successfully parsed messages for each protocol on target3
64	U2[8]	-	msg5	msgs	Number of successfully parsed messages for each protocol on target4
80	U2[8]	-	msg6	msgs	Number of successfully parsed messages for each protocol on target5
96	U4[6]	-	skipped	bytes	Number skipped bytes for each target

MON-RXBUF (0x0A 0x07)

Receiver Buffer Status

<i>Message</i>	MON-RXBUF				
<i>Description</i>	Receiver Buffer Status				
<i>Firmware</i>	Supported on u-blox 5 from firmware version 4.00 up to version 6.02.				
<i>Type</i>	Periodic/Polled				
<i>Comment</i>	-				
<i>Message Structure</i>	<i>Header</i>	<i>ID</i>	<i>Length (Bytes)</i>	<i>Payload</i>	<i>Checksum</i>
	0xB5 0x62	0x0A 0x07	24	see below	CK_A CK_B
<i>Payload Contents:</i>					
<i>Byte Offset</i>	<i>Number Format</i>	<i>Scaling</i>	<i>Name</i>	<i>Unit</i>	<i>Description</i>
0	U2[6]	-	pending	bytes	Number of bytes pending in receiver buffer for each target

MON-RXBUF continued

Byte Offset	Number Format	Scaling	Name	Unit	Description
12	U1[6]	-	usage	%	Maximum usage receiver buffer during the last sysmon period for each target
18	U1[6]	-	peakUsage	%	Maximum usage receiver buffer for each target

MON-TXBUF (0x0A 0x08)

Transmitter Buffer Status

Message	MON-TXBUF				
Description	Transmitter Buffer Status				
Firmware	Supported on u-blox 5 from firmware version 4.00 up to version 6.02.				
Type	Periodic/Polled				
Comment	-				
Message Structure	Header	ID	Length (Bytes)	Payload	Checksum
	0xB5 0x62	0x0A 0x08	28	see below	CK_A CK_B
Payload Contents:					
Byte Offset	Number Format	Scaling	Name	Unit	Description
0	U2[6]	-	pending	bytes	Number of bytes pending in transmitter buffer for each target
12	U1[6]	-	usage	%	Maximum usage transmitter buffer during the last sysmon period for each target
18	U1[6]	-	peakUsage	%	Maximum usage transmitter buffer for each target
24	U1	-	tUsage	%	Maximum usage of transmitter buffer during the last sysmon period for all targets
25	U1	-	tPeakusage	%	Maximum usage of transmitter buffer for all targets
26	X1	-	errors	-	Error bitmask (see graphic below)
27	U1	-	res	-	reserved

Bitfield errors

This Graphic explains the bits of errors

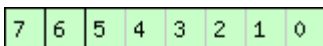

alloc
 mem
 limit

signed value
 unsigned value
 reserved

Name	Description
limit	Buffer limit of corresponding target reached
mem	Memory Allocation error
alloc	Allocation error (TX buffer full)

MON-HW (0x0A 0x09)

Hardware Status

<i>Message</i>	MON-HW				
<i>Description</i>	Hardware Status				
<i>Firmware</i>	Supported on u-blox 5 from firmware version 4.00 up to version 5.00.				
<i>Type</i>	Periodic/Polled				
<i>Comment</i>	Status of different aspect of the hardware, such as Antenna, PIO/Peripheral Pins, Noise Level, Automatic Gain Control (AGC)				
<i>Message Structure</i>	<i>Header</i>	<i>ID</i>	<i>Length (Bytes)</i>	<i>Payload</i>	<i>Checksum</i>
	0xB5 0x62	0x0A 0x09	68	see below	CK_A CK_B
<i>Payload Contents:</i>					
<i>Byte Offset</i>	<i>Number Format</i>	<i>Scaling</i>	<i>Name</i>	<i>Unit</i>	<i>Description</i>
0	X4	-	pinSel	-	Mask of Pins Set as Peripheral/PIO
4	X4	-	pinBank	-	Mask of Pins Set as Bank A/B
8	X4	-	pinDir	-	Mask of Pins Set as Input/Output
12	X4	-	pinVal	-	Mask of Pins Value Low/High
16	U2	-	noisePerMS	-	Noise Level as measured by the GPS Core
18	U2	-	agcCnt	-	AGC Monitor (counts SIGHI xor SIGLO, range 0 to 8191)
20	U1	-	aStatus	-	Status of the Antenna Supervisor State Machine (0=INIT, 1=DONTKNOW, 2=OK, 3=SHORT, 4=OPEN)
21	U1	-	aPower	-	Current PowerStatus of Antenna (0=OFF, 1=ON, 2=DONTKNOW)
22	X1	-	flags	-	Flags (see graphic below)
23	U1	-	res1	-	Reserved
24	X4	-	usedMask	-	Mask of Pins that are used by the Virtual Pin Manager
28	U1[25]	-	VP	-	Array of Pin Mappings for each of the 25 Physical Pins
53	U1[3]	-	res2	-	Reserved
56	X4	-	pinIrq	-	Mask of Pins Value using the PIO Irq
60	X4	-	pullH	-	Mask of Pins Value using the PIO Pull High Resistor
64	X4	-	pullL	-	Mask of Pins Value using the PIO Pull Low Resistor

Bitfield flags

This Graphic explains the bits of flags

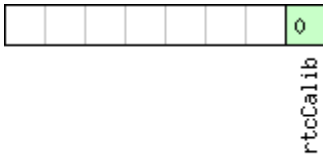

signed value
 unsigned value
 reserved

Name	Description
rtcCalib	RTC is calibrated

Hardware Status

Message	MON-HW				
Description	Hardware Status				
Firmware	Supported on u-blox 5 from firmware version 6.00 up to version 6.02.				
Type	Periodic/Polled				
Comment	Status of different aspect of the hardware, such as Antenna, PIO/Peripheral Pins, Noise Level, Automatic Gain Control (AGC)				
Message Structure	Header	ID	Length (Bytes)	Payload	Checksum
	0xB5 0x62	0x0A 0x09	68	see below	CK_A CK_B
Payload Contents:					
Byte Offset	Number Format	Scaling	Name	Unit	Description
0	X4	-	pinSel	-	Mask of Pins Set as Peripheral/PIO
4	X4	-	pinBank	-	Mask of Pins Set as Bank A/B
8	X4	-	pinDir	-	Mask of Pins Set as Input/Output
12	X4	-	pinVal	-	Mask of Pins Value Low/High
16	U2	-	noisePerMS	-	Noise Level as measured by the GPS Core
18	U2	-	agcCnt	-	AGC Monitor (counts SIGHI xor SIGLO, range 0 to 8191)
20	U1	-	aStatus	-	Status of the Antenna Supervisor State Machine (0=INIT, 1=DONTKNOW, 2=OK, 3=SHORT, 4=OPEN)
21	U1	-	aPower	-	Current PowerStatus of Antenna (0=OFF, 1=ON, 2=DONTKNOW)
22	X1	-	flags	-	Flags (see graphic below)
23	U1	-	res1	-	Reserved
24	X4	-	usedMask	-	Mask of Pins that are used by the Virtual Pin Manager
28	U1[25]	-	VP	-	Array of Pin Mappings for each of the 25 Physical Pins
53	U1	-	jamInd	-	Jamming indicator, scaled (0 = no jamming, 255 = strong jamming)
54	U1[2]	-	res2	-	Reserved
56	X4	-	pinIrq	-	Mask of Pins Value using the PIO Irq
60	X4	-	pullH	-	Mask of Pins Value using the PIO Pull High Resistor

MON-HW continued

Byte Offset	Number Format	Scaling	Name	Unit	Description
64	X4	-	pullL	-	Mask of Pins Value using the PIO Pull Low Resistor

Bitfield flags

This Graphic explains the bits of flags

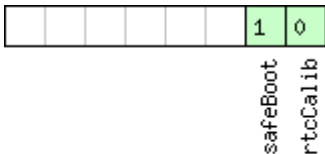

- signed value
- unsigned value
- reserved

Name	Description
rtcCalib	RTC is calibrated
safeBoot	safeBoot mode (0 = inactive, 1 = active)

MON-HW2 (0x0A 0x0B)

Extended Hardware Status

Message	MON-HW2				
Description	Extended Hardware Status				
Firmware	Supported on u-blox 5 from firmware version 6.00 up to version 6.02.				
Type	Periodic/Polled				
Comment	Status of different aspects of the hardware such as Imbalance, Low-Level Configuration and POST Results. The first four parameters of this message represent the complex signal from the RF front end. The following rules of thumb apply: <ul style="list-style-type: none"> The smaller the absolute value of the variable $ofsI$ and $ofsQ$ respectively, the better. Ideally, the magnitude of the I-part ($magI$) and the Q-part ($magQ$) of the complex signal should be the same. 				
Message Structure	Header	ID	Length (Bytes)	Payload	Checksum
	0xB5 0x62	0x0A 0x0B	28	see below	CK_A CK_B
Payload Contents:					
Byte Offset	Number Format	Scaling	Name	Unit	Description
0	I1	-	$ofsI$	-	Imbalance of I-part of complex signal, scaled (-128 = max. negative imbalance, 127 = max. positive imbalance)
1	U1	-	$magI$	-	Magnitude of I-part of complex signal, scaled (0 = no signal, 255 = max. magnitude)
2	I1	-	$ofsQ$	-	Imbalance of Q-part of complex signal, scaled (-128 = max. negative imbalance, 127 = max. positive imbalance)

MON-HW2 continued

Byte Offset	Number Format	Scaling	Name	Unit	Description
3	U1	-	magQ	-	Magnitude of Q-part of complex signal, scaled (0 = no signal, 255 = max. magnitude)
4	U1	-	cfgSource	-	Source of low-level configuration (114 = ROM, 111 = OTP, 112 = config pins, 102 = flash image)
5	U1[3]	-	pad1	-	Reserved
8	X4	-	lowLevCfg	-	Low-level configuration
12	X4[2]	-	res1	-	Reserved
20	X4	-	postStatus	-	POST status word
24	U4	-	res2	-	Reserved

MON-RXR (0x0A 0x21)

Receiver Status Information

Message	MON-RXR				
Description	Receiver Status Information				
Firmware	Supported on u-blox 5 from firmware version 6.00 up to version 6.02.				
Type	Get				
Comment	The receiver ready message is sent when the receiver changes from or to backup mode.				
Message Structure	Header	ID	Length (Bytes)	Payload	Checksum
	0xB5 0x62	0x0A 0x21	1	see below	CK_A CK_B
Payload Contents:					
Byte Offset	Number Format	Scaling	Name	Unit	Description
0	U1	-	flags	-	Receiver status flags (see graphic below)

Bitfield flags

This Graphic explains the bits of flags

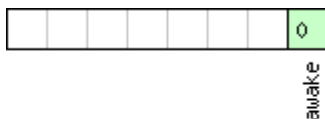

- signed value
- unsigned value
- reserved

Name	Description
awake	not in Backup mode

AID (0x0B)

AssistNow Aiding Messages: i.e. Ephemeris, Almanac, other A-GPS data input. Messages in this class are used to send aiding data to the receiver.

AID-REQ (0x0B 0x00)

Sends a poll (AID-DATA) for all GPS Aiding Data

<i>Message</i>	AID-REQ				
<i>Description</i>	Sends a poll (AID-DATA) for all GPS Aiding Data				
<i>Firmware</i>	Supported on u-blox 5 from firmware version 4.00 up to version 6.02.				
<i>Type</i>	Virtual				
<i>Comment</i>	AID-REQ is not a message but a placeholder for configuration purposes. If the virtual AID-REQ is configured to be output (see CFG-MSG), the receiver will output a request for aiding data (AID-DATA) after a start-up if its internally stored data (position, time) don't allow it to perform a hot start. If position and time information could be retrieved from internal storage, no AID-REQ will be sent, even when the receiver is missing valid ephemeris data.				
<i>Message Structure</i>	<i>Header</i>	<i>ID</i>	<i>Length (Bytes)</i>	<i>Payload</i>	<i>Checksum</i>
	0xB5 0x62	0x0B 0x00	0	see below	CK_A CK_B
<i>No payload</i>					

AID-INI (0x0B 0x01)

Poll GPS Initial Aiding Data

<i>Message</i>	AID-INI				
<i>Description</i>	Poll GPS Initial Aiding Data				
<i>Firmware</i>	Supported on u-blox 5 from firmware version 4.00 up to version 6.02.				
<i>Type</i>	Poll Request				
<i>Comment</i>	This message has an empty payload! -				
<i>Message Structure</i>	<i>Header</i>	<i>ID</i>	<i>Length (Bytes)</i>	<i>Payload</i>	<i>Checksum</i>
	0xB5 0x62	0x0B 0x01	0	see below	CK_A CK_B
<i>No payload</i>					

Aiding position, time, frequency, clock drift

Message	AID-INI				
Description	Aiding position, time, frequency, clock drift				
Firmware	Supported on u-blox 5 from firmware version 4.00 up to version 6.02.				
Type	Polled				
Comment	This message contains position, time and clock drift information. The position can be input in either the ECEF X/Y/Z coordinate system or as lat/lon/height. The time can either be input as inexact value via the standard communication interface, suffering from latency depending on the baudrate, or using hardware time synchronization where an accurate time pulse is input on the external interrupts. It is also possible to supply hardware frequency aiding by connecting a continuous signal to an external interrupt.				
Message Structure	Header	ID	Length (Bytes)	Payload	Checksum
	0xB5 0x62	0x0B 0x01	48	see below	CK_A CK_B
Payload Contents:					
Byte Offset	Number Format	Scaling	Name	Unit	Description
0	I4	-	ecefXOrLat	cm_or_deg*1e-7	WGS84 ECEF X coordinate or latitude, depending on flags below
4	I4	-	ecefYOrLon	cm_or_deg*1e-7	WGS84 ECEF Y coordinate or longitude, depending on flags below
8	I4	-	ecefZOrAlt	cm	WGS84 ECEF Z coordinate or altitude, depending on flags below
12	U4	-	posAcc	cm	Position accuracy (stddev)
16	X2	-	tmCfg	-	Time mark configuration (see graphic below)
18	U2	-	wn	-	Actual week number
20	U4	-	tow	ms	Actual time of week
24	I4	-	towNs	ns	Sub-millisecond part of time of week
28	U4	-	tAccMs	ms	Milliseconds part of time accuracy
32	U4	-	tAccNs	ns	Nanoseconds part of time accuracy
36	I4	-	clkDOrFreq	ns/s_or_Hz*1e-2	Clock drift or frequency, depending on flags below
40	U4	-	clkDAccOrFreqAcc	ns/s_or_ppb	Accuracy of clock drift or frequency, depending on flags below
44	X4	-	flags	-	Bitmask with the following flags (see graphic below)

Bitfield tmCfg

This Graphic explains the bits of tmCfg

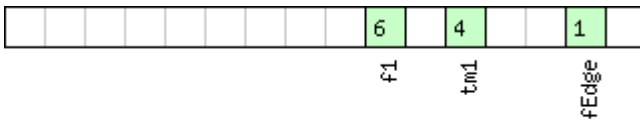

- signed value
- unsigned value
- reserved

Name	Description
fEdge	use falling edge (default rising)
tm1	time mark on extint 1 (default extint 0)
f1	frequency on extint 1 (default extint 0)

Bitfield flags

This Graphic explains the bits of flags

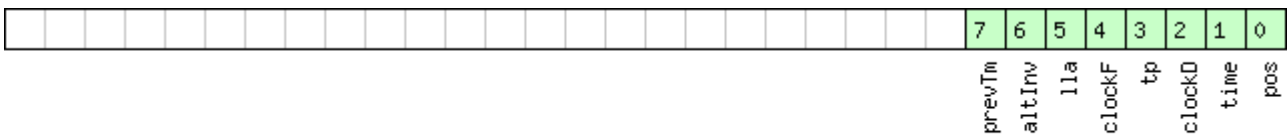

- signed value
- unsigned value
- reserved

Name	Description
pos	Position is valid
time	Time is valid
clockD	Clock drift data contains valid clock drift, must not be set together with clockF
tp	Use time pulse
clockF	Clock drift data contains valid frequency, must not be set together with clockD
lla	Position is given in LAT/LON/ALT (default is ECEF)
altInv	Altitude is not valid, in case lla was set
prevTm	Use time mark received before AID-INI message (default uses mark received after message)

AID-HUI (0x0B 0x02)

Poll GPS Health, UTC and ionosphere parameters

Message	AID-HUI				
Description	Poll GPS Health, UTC and ionosphere parameters				
Firmware	Supported on u-blox 5 from firmware version 4.00 up to version 6.02.				
Type	Poll Request				
Comment	This message has an empty payload! -				
Message Structure	Header	ID	Length (Bytes)	Payload	Checksum
	0xB5 0x62	0x0B 0x02	0	see below	CK_A CK_B
No payload					

GPS Health, UTC and ionosphere parameters

Message		AID-HUI				
Description		GPS Health, UTC and ionosphere parameters				
Firmware		Supported on u-blox 5 from firmware version 4.00 up to version 6.02.				
Type		Input/Output Message				
Comment		This message contains a health bit mask, UTC time and Klobuchar parameters. For more information on these parameters, please see the ICD-GPS-200 documentation.				
Message Structure		Header	ID	Length (Bytes)	Payload	Checksum
		0xB5 0x62	0x0B 0x02	72	see below	CK_A CK_B
Payload Contents:						
Byte Offset	Number Format	Scaling	Name	Unit	Description	
0	X4	-	health	-	Bitmask, every bit represent a GPS SV (1-32). If the bit is set the SV is healthy.	
4	R8	-	utcA1	-	UTC - parameter A1	
12	R8	-	utcA0	-	UTC - parameter A0	
20	I4	-	utcTOW	-	UTC - reference time of week	
24	I2	-	utcWNT	-	UTC - reference week number	
26	I2	-	utcLS	-	UTC - time difference due to leap seconds before event	
28	I2	-	utcWNF	-	UTC - week number when next leap second event occurs	
30	I2	-	utcDN	-	UTC - day of week when next leap second event occurs	
32	I2	-	utcLSF	-	UTC - time difference due to leap seconds after event	
34	I2	-	utcSpare	-	UTC - Spare to ensure structure is a multiple of 4 bytes	
36	R4	-	klobA0	s	Klobuchar - alpha 0	
40	R4	-	klobA1	s/semicircle	Klobuchar - alpha 1	
44	R4	-	klobA2	s/semicircle ²	Klobuchar - alpha 2	
48	R4	-	klobA3	s/semicircle ³	Klobuchar - alpha 3	
52	R4	-	klobB0	s	Klobuchar - beta 0	
56	R4	-	klobB1	s/semicircle	Klobuchar - beta 1	
60	R4	-	klobB2	s/semicircle ²	Klobuchar - beta 2	
64	R4	-	klobB3	s/semicircle ³	Klobuchar - beta 3	
68	X4	-	flags	-	flags (see graphic below)	

Bitfield flags

This Graphic explains the bits of flags

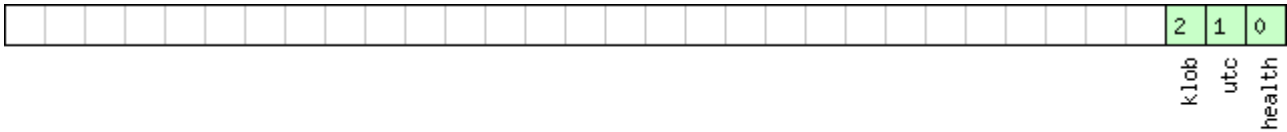

- signed value
- unsigned value
- reserved

Name	Description
health	Healthmask field in this message is valid
utc	UTC parameter fields in this message are valid
klob	Klobuchar parameter fields in this message are valid

AID-DATA (0x0B 0x10)

Polls all GPS Initial Aiding Data

Message	AID-DATA				
Description	Polls all GPS Initial Aiding Data				
Firmware	Supported on u-blox 5 from firmware version 4.00 up to version 6.02.				
Type	Poll				
Comment	If this poll is received, the messages AID-INI, AID-HUI, AID-EPH and AID-ALM are sent.				
Message Structure	Header	ID	Length (Bytes)	Payload	Checksum
	0xB5 0x62	0x0B 0x10	0	see below	CK_A CK_B
No payload					

AID-ALM (0x0B 0x30)

Poll GPS Aiding Almanac Data

Message	AID-ALM				
Description	Poll GPS Aiding Almanac Data				
Firmware	Supported on u-blox 5 from firmware version 4.00 up to version 6.02.				
Type	Poll Request				
Comment	This message has an empty payload! Poll GPS Aiding Data (Almanac) for all 32 SVs by sending this message to the receiver without any payload. The receiver will return 32 messages of type AID-ALM as defined below.				
Message Structure	Header	ID	Length (Bytes)	Payload	Checksum
	0xB5 0x62	0x0B 0x30	0	see below	CK_A CK_B
No payload					

Poll GPS Aiding Almanac Data for a SV

Message	AID-ALM				
Description	Poll GPS Aiding Almanac Data for a SV				
Firmware	Supported on u-blox 5 from firmware version 4.00 up to version 6.02.				
Type	Poll Request				
Comment	Poll GPS Aiding Data (Almanac) for an SV by sending this message to the receiver. The receiver will return one message of type AID-ALM as defined below.				
Message Structure	Header	ID	Length (Bytes)	Payload	Checksum
	0xB5 0x62	0x0B 0x30	1	see below	CK_A CK_B
Payload Contents:					
Byte Offset	Number Format	Scaling	Name	Unit	Description
0	U1	-	svid	-	SV ID for which the receiver shall return its Almanac Data (Valid Range: 1 .. 32 or 51, 56, 63).

GPS Aiding Almanac Input/Output Message

Message	AID-ALM				
Description	GPS Aiding Almanac Input/Output Message				
Firmware	Supported on u-blox 5 from firmware version 4.00 up to version 6.02.				
Type	Input/Output Message				
Comment	<ul style="list-style-type: none"> If the WEEK Value is 0, DWRD0 to DWRD7 are not sent as the Almanac is not available for the given SV. DWORD0 to DWORD7 contain the 8 words following the Hand-Over Word (HOW) from the GPS navigation message, either pages 1 to 24 of sub-frame 5 or pages 2 to 10 of subframe 4. See IS-GPS-200 for a full description of the contents of the Almanac pages. In DWORD0 to DWORD7, the parity bits have been removed, and the 24 bits of data are located in Bits 0 to 23. Bits 24 to 31 shall be ignored. Example: Parameter e (Eccentricity) from Almanac Subframe 4/5, Word 3, Bits 69-84 within the subframe can be found in DWRD0, Bits 15-0 whereas Bit 0 is the LSB. 				
Message Structure	Header	ID	Length (Bytes)	Payload	Checksum
	0xB5 0x62	0x0B 0x30	(8) or (40)	see below	CK_A CK_B
Payload Contents:					
Byte Offset	Number Format	Scaling	Name	Unit	Description
0	U4	-	svid	-	SV ID for which this Almanac Data is (Valid Range: 1 .. 32 or 51, 56, 63).
4	U4	-	week	-	Issue Date of Almanac (GPS week number)
Start of optional block					
8	U4[8]	-	dwrđ	-	Almanac Words
End of optional block					

AID-EPH (0x0B 0x31)

Poll GPS Aiding Ephemeris Data

<i>Message</i>	AID-EPH				
<i>Description</i>	Poll GPS Aiding Ephemeris Data				
<i>Firmware</i>	Supported on u-blox 5 from firmware version 4.00 up to version 6.02.				
<i>Type</i>	Poll Request				
<i>Comment</i>	This message has an empty payload! Poll GPS Aiding Data (Ephemeris) for all 32 SVs by sending this message to the receiver without any payload. The receiver will return 32 messages of type AID-EPH as defined below.				
<i>Message Structure</i>	<i>Header</i>	<i>ID</i>	<i>Length (Bytes)</i>	<i>Payload</i>	<i>Checksum</i>
	0xB5 0x62	0x0B 0x31	0	see below	CK_A CK_B
No payload					

Poll GPS Aiding Ephemeris Data for a SV

<i>Message</i>	AID-EPH				
<i>Description</i>	Poll GPS Aiding Ephemeris Data for a SV				
<i>Firmware</i>	Supported on u-blox 5 from firmware version 4.00 up to version 6.02.				
<i>Type</i>	Poll Request				
<i>Comment</i>	Poll GPS Constellation Data (Ephemeris) for an SV by sending this message to the receiver. The receiver will return one message of type AID-EPH as defined below.				
<i>Message Structure</i>	<i>Header</i>	<i>ID</i>	<i>Length (Bytes)</i>	<i>Payload</i>	<i>Checksum</i>
	0xB5 0x62	0x0B 0x31	1	see below	CK_A CK_B
<i>Payload Contents:</i>					
<i>Byte Offset</i>	<i>Number Format</i>	<i>Scaling</i>	<i>Name</i>	<i>Unit</i>	<i>Description</i>
0	U1	-	svid	-	SV ID for which the receiver shall return its Ephemeris Data (Valid Range: 1 .. 32).

GPS Aiding Ephemeris Input/Output Message

Message	AID-EPH				
Description	GPS Aiding Ephemeris Input/Output Message				
Firmware	Supported on u-blox 5 from firmware version 4.00 up to version 6.02.				
Type	Input/Output Message				
Comment	<ul style="list-style-type: none"> SF1D0 to SF3D7 is only sent if ephemeris is available for this SV. If not, the payload may be reduced to 8 Bytes, or all bytes are set to zero, indicating that this SV Number does not have valid ephemeris for the moment. SF1D0 to SF3D7 contain the 24 words following the Hand-Over Word (HOW) from the GPS navigation message, subframes 1 to 3. See IS-GPS-200 for a full description of the contents of the Subframes. In SF1D0 to SF3D7, the parity bits have been removed, and the 24 bits of data are located in Bits 0 to 23. Bits 24 to 31 shall be ignored. 				
Message Structure	Header	ID	Length (Bytes)	Payload	Checksum
	0xB5 0x62	0x0B 0x31	(8) or (104)	see below	CK_A CK_B
Payload Contents:					
Byte Offset	Number Format	Scaling	Name	Unit	Description
0	U4	-	svid	-	SV ID for which this ephemeris data is (Valid Range: 1 .. 32).
4	U4	-	how	-	Hand-Over Word of first Subframe. This is required if data is sent to the receiver. 0 indicates that no Ephemeris Data is following.
Start of optional block					
8	U4[8]	-	sf1d	-	Subframe 1 Words 3..10 (SF1D0..SF1D7)
40	U4[8]	-	sf2d	-	Subframe 2 Words 3..10 (SF2D0..SF2D7)
72	U4[8]	-	sf3d	-	Subframe 3 Words 3..10 (SF3D0..SF3D7)
End of optional block					

AID-ALPSRV (0x0B 0x32)

ALP client requests AlmanacPlus data from server

Message	AID-ALPSRV				
Description	ALP client requests AlmanacPlus data from server				
Firmware	Supported on u-blox 5 from firmware version 4.00 up to version 6.02.				
Type	Output Message				
Comment	This message is sent by the ALP client to the ALP server in order to request data. The given identifier must be prepended to the requested data when submitting the data.				
Message Structure	Header	ID	Length (Bytes)	Payload	Checksum
	0xB5 0x62	0x0B 0x32	16	see below	CK_A CK_B
Payload Contents:					
Byte Offset	Number Format	Scaling	Name	Unit	Description

AID-ALPSRV continued

Byte Offset	Number Format	Scaling	Name	Unit	Description
0	U1	-	idSize	bytes	Identifier size. This data, beginning at message start, must prepend the returned data.
1	U1	-	type	-	Requested data type. Must be different from 0xff, otherwise this is not a data request.
2	U2	-	ofs	-	Requested data offset [16bit words]
4	U2	-	size	-	Requested data size [16bit words]
6	U2	-	fileId	-	Unused when requesting data, filled in when sending back the data
8	U2	-	dataSize	bytes	Actual data size. Unused when requesting data, filled in when sending back the data.
10	U1	-	id1	-	Identifier data
11	U1	-	id2	-	Identifier data
12	U4	-	id3	-	Identifier data

ALP server sends AlmanacPlus data to client

Message	AID-ALPSRV				
Description	ALP server sends AlmanacPlus data to client				
Firmware	Supported on u-blox 5 from firmware version 4.00 up to version 6.02.				
Type	Input Message				
Comment	This message is sent by the ALP server to the ALP client and is usually sent in response to a data request. The server copies the identifier from the request and fills in the dataSize and fileId fields.				
Message Structure	Header	ID	Length (Bytes)	Payload	Checksum
	0xB5 0x62	0x0B 0x32	16 + 1*dataSize	see below	CK_A CK_B
Payload Contents:					
Byte Offset	Number Format	Scaling	Name	Unit	Description
0	U1	-	idSize	bytes	Identifier size
1	U1	-	type	-	Requested data type
2	U2	-	ofs	-	Requested data offset [16bit words]
4	U2	-	size	-	Requested data size [16bit words]
6	U2	-	fileId	-	Corresponding ALP file ID, must be filled in by the server!
8	U2	-	dataSize	bytes	Actual data contained in this message, must be filled in by the server!
10	U1	-	id1	-	Identifier data
11	U1	-	id2	-	Identifier data
12	U4	-	id3	-	Identifier data
Start of repeated block (dataSize times)					
16 + 1*N	U1	-	data	-	Data for the ALP client
End of repeated block					

ALP client sends AlmanacPlus data to server.

Message	AID-ALPSRV				
Description	ALP client sends AlmanacPlus data to server.				
Firmware	Supported on u-blox 5 from firmware version 4.00 up to version 6.02.				
Type	Output Message				
Comment	This message is sent by the ALP client to the ALP server in order to submit updated data. The server can either replace the current data at this position or ignore this new data (which will result in degraded performance).				
Message Structure	Header	ID	Length (Bytes)	Payload	Checksum
	0xB5 0x62	0x0B 0x32	8 + 2*size	see below	CK_A CK_B
Payload Contents:					
Byte Offset	Number Format	Scaling	Name	Unit	Description
0	U1	-	idSize	bytes	Identifier size
1	U1	-	type	-	Set to 0xff to mark that is *not* a data request
2	U2	-	ofs	-	Data offset [16bit words]
4	U2	-	size	-	Data size [16bit words]
6	U2	-	fileId	-	Corresponding ALP file id
Start of repeated block (size times)					
8 + 2*N	U2	-	data	-	16bit word data to be submitted to the ALP server
End of repeated block					

AID-ALP (0x0B 0x50)

ALP file data transfer to the receiver

Message	AID-ALP				
Description	ALP file data transfer to the receiver				
Firmware	Supported on u-blox 5 from firmware version 4.00 up to version 6.02.				
Type	Input message				
Comment	This message is used to transfer a chunk of data from the AlmanacPlus file to the receiver. Upon reception of this message, the receiver will write the payload data to its internal non-volatile memory, eventually also erasing that part of the memory first. Make sure that the payload size is even sized (i.e. always a multiple of 2). Do not use payloads larger than ~ 700 bytes, as this would exceed the receiver's internal buffering capabilities. The receiver will (not-) acknowledge this message using the message alternatives given below. The host shall wait for an acknowledge message before sending the next chunk.				
Message Structure	Header	ID	Length (Bytes)	Payload	Checksum
	0xB5 0x62	0x0B 0x50	0 + 2*Variable	see below	CK_A CK_B
Payload Contents:					
Byte Offset	Number Format	Scaling	Name	Unit	Description
Start of repeated block (Variable times)					

AID-ALP continued

Byte Offset	Number Format	Scaling	Name	Unit	Description
N*2	U2	-	alpData	-	ALP file data
<i>End of repeated block</i>					

Mark end of data transfer

<i>Message</i>	AID-ALP				
<i>Description</i>	Mark end of data transfer				
<i>Firmware</i>	Supported on u-blox 5 from firmware version 4.00 up to version 6.02.				
<i>Type</i>	Input message				
<i>Comment</i>	This message is used to indicate that all chunks have been transferred, and normal receiver operation can resume. Upon reception of this message, the receiver will verify all chunks received so far, and enable AssistNow Offline and GPS receiver operation if successful. This message could also be sent to cancel an incomplete download.				
<i>Message Structure</i>	<i>Header</i>	<i>ID</i>	<i>Length (Bytes)</i>	<i>Payload</i>	<i>Checksum</i>
	0xB5 0x62	0x0B 0x50	1	see below	CK_A CK_B
<i>Payload Contents:</i>					
<i>Byte Offset</i>	<i>Number Format</i>	<i>Scaling</i>	<i>Name</i>	<i>Unit</i>	<i>Description</i>
0	U1	-	dummy	-	Value is ignored

Acknowledges a data transfer

<i>Message</i>	AID-ALP				
<i>Description</i>	Acknowledges a data transfer				
<i>Firmware</i>	Supported on u-blox 5 from firmware version 4.00 up to version 6.02.				
<i>Type</i>	Output message				
<i>Comment</i>	This message from the receiver acknowledges successful processing of a previously received chunk of data with the "Chunk Transfer" Message. This message will also be sent once a "Stop" message has been received, and the integrity of all chunks received so far has been checked successfully.				
<i>Message Structure</i>	<i>Header</i>	<i>ID</i>	<i>Length (Bytes)</i>	<i>Payload</i>	<i>Checksum</i>
	0xB5 0x62	0x0B 0x50	1	see below	CK_A CK_B
<i>Payload Contents:</i>					
<i>Byte Offset</i>	<i>Number Format</i>	<i>Scaling</i>	<i>Name</i>	<i>Unit</i>	<i>Description</i>
0	U1	-	ack	-	Set to 0x01

Indicate problems with a data transfer

<i>Message</i>	AID-ALP				
<i>Description</i>	Indicate problems with a data transfer				
<i>Firmware</i>	Supported on u-blox 5 from firmware version 4.00 up to version 6.02.				
<i>Type</i>	Output message				
<i>Comment</i>	This message from the receiver indicates that an error has occurred while processing and storing the data received with the "Chunk Transfer" message. This message will also be sent once a stop command has been received, and the integrity of all chunks received failed.				
<i>Message Structure</i>	<i>Header</i>	<i>ID</i>	<i>Length (Bytes)</i>	<i>Payload</i>	<i>Checksum</i>
	0xB5 0x62	0x0B 0x50	1	see below	CK_A CK_B
<i>Payload Contents:</i>					
<i>Byte Offset</i>	<i>Number Format</i>	<i>Scaling</i>	<i>Name</i>	<i>Unit</i>	<i>Description</i>
0	U1	-	nak	-	Set to 0x00

Poll the AlmanacPlus status

<i>Message</i>	AID-ALP				
<i>Description</i>	Poll the AlmanacPlus status				
<i>Firmware</i>	Supported on u-blox 5 from firmware version 4.00 up to version 5.00.				
<i>Type</i>	Periodic/Polled				
<i>Comment</i>	-				
<i>Message Structure</i>	<i>Header</i>	<i>ID</i>	<i>Length (Bytes)</i>	<i>Payload</i>	<i>Checksum</i>
	0xB5 0x62	0x0B 0x50	24	see below	CK_A CK_B
<i>Payload Contents:</i>					
<i>Byte Offset</i>	<i>Number Format</i>	<i>Scaling</i>	<i>Name</i>	<i>Unit</i>	<i>Description</i>
0	U4	-	predTow	s	Prediction start time of week
4	U4	-	predDur	s	Prediction duration from start of first data set to end of last data set
8	I4	-	age	s	Current age of ALP data
12	U2	-	predWno	-	Prediction start week number
14	U2	-	almWno	-	Truncated week number of reference almanac
16	U4	-	res1	-	Reserved for future use
20	U1	-	svs	-	Number of satellite data sets contained in the ALP data
21	U1	-	res2	-	Reserved for future use
22	U1	-	res3	-	Reserved for future use
23	U1	-	res4	-	Reserved for future use

Poll the AlmanacPlus status

Message	AID-ALP				
Description	Poll the AlmanacPlus status				
Firmware	Supported on u-blox 5 from firmware version 6.00 up to version 6.02.				
Type	Periodic/Polled				
Comment	-				
Message Structure	Header	ID	Length (Bytes)	Payload	Checksum
	0xB5 0x62	0x0B 0x50	24	see below	CK_A CK_B
Payload Contents:					
Byte Offset	Number Format	Scaling	Name	Unit	Description
0	U4	-	predTow	s	Prediction start time of week
4	U4	-	predDur	s	Prediction duration from start of first data set to end of last data set
8	I4	-	age	s	Current age of ALP data
12	U2	-	predWno	-	Prediction start week number
14	U2	-	almWno	-	Truncated week number of reference almanac
16	U4	-	res1	-	Reserved
20	U1	-	svs	-	Number of satellite data sets contained in the ALP data
21	U1	-	res2	-	Reserved
22	U2	-	res3	-	Reserved

TIM (0x0D)

Timing Messages: i.e. Timepulse Output, Timemark Results.

Messages in this class are output by the receiver, giving information on Timepulse and Timemark measurements.

TIM-TP (0x0D 0x01)

Timepulse Timedata

Message	TIM-TP				
Description	Timepulse Timedata				
Firmware	Supported on u-blox 5 from firmware version 4.00 up to version 6.02.				
Type	Periodic/Polled				
Comment	This message contains information for high precision timing. Note that contents are correct only if the timepulse is set to one pulse per second.				
Message Structure	Header	ID	Length (Bytes)	Payload	Checksum
	0xB5 0x62	0x0D 0x01	16	see below	CK_A CK_B
Payload Contents:					
Byte Offset	Number Format	Scaling	Name	Unit	Description
0	U4	-	towMS	ms	Timepulse time of week according to time base
4	U4	2 ⁻³²	towSubMS	ms	Submillisecond part of TOWMS
8	I4	-	qErr	ps	Quantization error of timepulse.
12	U2	-	week	weeks	Timepulse week number according to time base
14	X1	-	flags	-	bitmask (see graphic below)
15	U1	-	res	-	unused

Bitfield flags

This Graphic explains the bits of flags

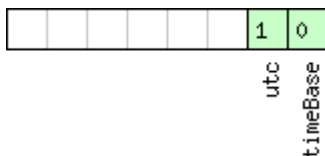

- signed value
- unsigned value
- reserved

Name	Description
timeBase	0=Time base is GPS 1=Time base is UTC
utc	0=UTC not available 1=UTC available

TIM-TM2 (0x0D 0x03)

Time mark data

Message	TIM-TM2				
Description	Time mark data				
Firmware	Supported on u-blox 5 from firmware version 4.00 up to version 6.02.				
Type	Periodic/Polled				
Comment	This message contains information for high precision time stamping / pulse counting. The delay figures and timebase given in CFG-TP are also applied to the time results output in this message.				
Message Structure	Header	ID	Length (Bytes)	Payload	Checksum
	0xB5 0x62	0x0D 0x03	28	see below	CK_A CK_B
Payload Contents:					
Byte Offset	Number Format	Scaling	Name	Unit	Description
0	U1	-	ch	time	marker channel 0 or 1
1	X1	-	flags	-	Bitmask (see graphic below)
2	U2	-	count	-	edge counter.
4	U2	-	wnR	-	week number of last rising edge
6	U2	-	wnF	-	week number of last falling edge
8	U4	-	towMsR	ms	tow of rising edge
12	U4	-	towSubMsR	ns	millisecond fraction of tow of rising edge in nanoseconds
16	U4	-	towMsF	ms	tow of falling edge
20	U4	-	towSubMsF	ns	millisecond fraction of tow of falling edge in nanoseconds
24	U4	-	accEst	ns	Accuracy estimate

Bitfield flags

This Graphic explains the bits of flags

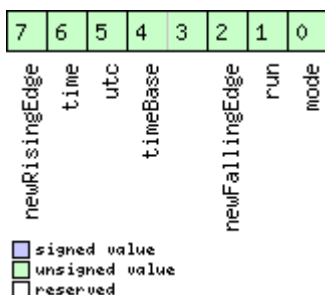

Name	Description
mode	0=single 1=running
run	0=armed 1=stopped
newFallingEdge	new falling edge detected

Bitfield flags Description continued

Name	Description
timeBase	0=Time base is Receiver Time 1=Time base is GPS 2=Time base is UTC
utc	0=UTC not available 1=UTC available
time	0=Time is not valid 1=Time is valid (Valid GPS fix)
newRisingEdge	new rising edge detected

TIM-SVIN (0x0D 0x04)

Survey-in data

Message	TIM-SVIN				
Description	Survey-in data				
Firmware	Supported on u-blox 5 from firmware version 5.00 up to version 6.02 (only available with premium feature timing).				
Type	Periodic/Polled				
Comment	This message is only supported on timing receivers This message contains information about survey-in parameters. For details about the Time Mode see section Time Mode Configuration .				
Message Structure	Header	ID	Length (Bytes)	Payload	Checksum
	0xB5 0x62	0x0D 0x04	28	see below	CK_A CK_B
Payload Contents:					
Byte Offset	Number Format	Scaling	Name	Unit	Description
0	U4	-	dur	s	Passed survey-in observation time
4	I4	-	meanX	cm	Current survey-in mean position ECEF X coordinate
8	I4	-	meanY	cm	Current survey-in mean position ECEF Y coordinate
12	I4	-	meanZ	cm	Current survey-in mean position ECEF Z coordinate
16	U4	-	meanV	mm ²	Current survey-in mean position 3D variance
20	U4	-	obs	-	Observations used during survey-in
24	U1	-	valid	-	Survey-in position validity flag
25	U1	-	active	-	Survey-in in progress flag
26	U2	-	reserved	-	Reserved

Appendix

u-blox 5 Default Settings

The default settings listed in this section apply to u-blox 5 ROM-based receivers with ROM version 4.00 and above. These values assume that the default levels of the configuration pins have been left unchanged. Default settings are dependent on the configuration pin settings, for information regarding these settings, consult the applicable Data Sheet.

Antenna Supervisor Settings (UBX-CFG-ANT)

For parameter and protocol description see section [UBX-CFG-ANT](#).

Antenna Settings

<i>Parameter</i>	<i>Default Setting</i>	<i>Unit</i>
Enable Control Signal	Enabled	
Enable Short Circuit Detection	Enabled	
Enable Short Circuit Power Down logic	Enabled	
Enable Automatic Short Circuit Recovery logic	Enabled	
Enable Open Circuit Detection	Disabled	

Datum Settings (UBX-CFG-DAT)

For parameter and protocol description see section [UBX-CFG-DAT](#).

Datum Default Settings

<i>Parameter</i>	<i>Default Setting</i>	<i>Unit</i>
Datum	0 – WGS84	

Navigation Settings (UBX-CFG-NAV5)

For parameter and protocol description see section [UBX-CFG-NAV5](#).

Navigation Default Settings

<i>Parameter</i>	<i>Default Setting</i>	<i>Unit</i>
Dynamic Platform Model	0 – Portable	
Fix Mode	Auto 2D/3D	#
Fixed Altitude	N/A	m
Fixed Altitude Variance	N/A	m ²
Min SV Elevation	5	deg
DR Timeout	0	s
PDOP Mask	25	-
TDOP Mask	25	-
P Accuracy	100	m
T Accuracy	300	m
Static Hold Threshold	0.00	m/s

Navigation Settings (UBX-CFG-NAVX5)

For parameter and protocol description see section [UBX-CFG-NAVX5](#).

Navigation Default Settings

<i>Parameter</i>	<i>Default Setting</i>	<i>Unit</i>
Apply min/max SVs settings	Enabled	
Apply minimum C/N0 settings	Enabled	
Apply initial 3D fix settings	Enabled	
Apply GPS weeknumber rollover settings	Enabled	
Minimum number of SV	3	
Maximum number of SV	16	
Minimum C/N0 for navigation	10	dBHz
Initial Fix must be 3D	Disabled	
Weeknumber rollover	1528 (u-blox 5 FW6)	

Output Rates (UBX-CFG-RATE)

For parameter and protocol description see section [UBX-CFG-RATE](#).

Output Rate Default Settings

<i>Parameter</i>	<i>Default Setting</i>	<i>Unit</i>
Time Source	1 – GPS time	
Measurement Period	1000	ms
Measurement Rate	1	Cycles

Fix Now Configuration (UBX-CFG-FXN)

For parameter and protocol description see section [UBX-CFG-FXN](#).

Fix Now Configuration Default Settings

<i>Parameter</i>	<i>Default Setting</i>	<i>Unit</i>
Sleep	Disabled	
Absolute Alignment	Enabled	
Use on/off time	Disabled	
Re-acquire time	0	ms
Acquire time	0	ms
Off time if re-acquisition failed	10000	ms
Off time if acquisition failed	10000	ms
On time	2000	ms

Fix Now Configuration Default Settings continued

Parameter	Default Setting	Unit
Off time	4294966200	ms
Base Tow	0	ms

Power Management Configuration (UBX-CFG-PM)

For parameter and protocol description see section [UBX-CFG-PM](#).

Power Management Default Settings

Parameter	Default Setting	Unit
External input selection	0	
External input control - wake-up	Disabled	
External input control - backup	Disabled	
Limit peak current	Disabled	
Wait for time fix	Disabled	
Update Real Time Clock	Disabled	
Update ephemeris	Enabled	
Update period	1000	ms
Search period	10000	ms
Grid offset	0	ms
On time	2	s
Minimum acquisition time	0	s

Receiver Manager Configuration (UBX-CFG-RXM)

For parameter and protocol description see section [UBX-CFG-RXM](#).

Power Management Default Settings

Parameter	Default Setting	Unit
Low power mode	0 - max performance mode	

SBAS Configuration (UBX-CFG-SBAS)

For parameter and protocol description see section [UBX-CFG-SBAS](#).

SBAS Configuration Default Settings

Parameter	Default Setting	Unit
SBAS Subsystem	Enabled	
Allow test mode usage	Disabled	
Ranging (Use SBAS for navigation)	Enabled	
Apply SBAS Correction Data	Enabled	
Apply integrity information	Disabled	

SBAS Configuration Default Settings continued

Parameter	Default Setting	Unit
Number of search channels	3	
PRN Codes	120, 122, 124, 126-127, 129, 131, 134-135, 137-138	

Port Setting (UBX-CFG-PRT)

For parameter and protocol description see section [UBX-CFG-PRT](#).

Port Default Settings

Parameter	Default Setting	Unit
DDC/I2C (Target0)		
Protocol in	0+1 – UBX+NMEA	
Protocol out	0+1 – UBX+NMEA	
USART1 (Target1)		
Protocol in	0+1 – UBX+NMEA	
Protocol out	0+1 – UBX+NMEA	
Baudrate	9600	baud
USART2 (Target2)		
Protocol in	None	
Protocol out	None	
Baudrate	9600	baud
USB (Target3)		
Protocol in	0+1 – UBX+NMEA	
Protocol out	0+1 – UBX+NMEA	
SPI (Target4)		
Protocol in	0+1 – UBX+NMEA	
Protocol out	0+1 – UBX+NMEA	

Port Setting (UBX-CFG-USB)

For parameter and protocol description see section [UBX-CFG-USB](#).

USB default settings

Parameter	Default Setting	Unit
Power Mode		
Power Mode	Bus powered	
Bus Current required	120	mA

Message Settings (UBX-CFG-MSG)

For parameter and protocol description see section [UBX-CFG-MSG](#).

Enabled output messages

Message	Type	All Targets
NMEA - GGA	Out	1
NMEA - GLL	Out	1
NMEA - GSA	Out	1

Enabled output messages continued

Message	Type	All Targets
NMEA - GSV	Out	1
NMEA - RMC	Out	1
NMEA - VTG	Out	1

NMEA Protocol Settings (UBX-CFG-NMEA)

For parameter and protocol description see section [UBX-CFG-NMEA](#).

NMEA Protocol Default Settings

Parameter	Default Setting	Unit
Enable position output even for invalid fixes	Disabled	
Enable position even for masked fixes	Disabled	
Enable time output even for invalid times	Disabled	
Enable time output even for invalid dates	Disabled	
Version	2.3	
Compatibility Mode	Disabled	
Consideration Mode	Enabled	
Number of SV	Unlimited	

INF Messages Settings (UBX-CFG-INF)

For parameter and protocol description see section [UBX-CFG-INF](#).

NMEA default enabled INF msg

Message	Type	All Targets	Range/Remark
INF-Error	Out	1	In NMEA Protocol only (GPTXT)
INF-Warning	Out	1	In NMEA Protocol only (GPTXT)
INF-Notice	Out	1	In NMEA Protocol only (GPTXT)
INF-Test	Out		
INF-Debug	Out		
INF-User	Out	1	In NMEA Protocol only (GPTXT)

Power Save Mode configuration settings (UBX-CFG-PM)

Power Save Mode configuration defaults

Configuration parameter	Default Value
Update Period	1000 [ms]
ON-Time	2 [s]
Search Period	10'000 [ms]
Min Acq. Time	0 [s]
Grid Offset	0 [ms]
Wait for Timefix	Disabled
Update RTC	Disabled
Update Ephemeris	Enabled
EXTINT Selection	EXTINT0

Power Save Mode configuration defaults continued

Configuration parameter	Default Value
EXTINT Forces ON	Disabled
EXTINT Forces OFF	Disabled
Limit Peak Current	Disabled

Timepulse Settings (UBX-CFG-TP)

For parameter and protocol description see section [UBX-CFG-TP](#).

Timepulse default settings

Parameter	Default Setting	Unit
Pulse Mode	+1 – rising	
Pulse Period	1000	ms
Pulse Length	100	ms
Time Source	1 – GPS time	
Cable Delay	50	ns
User Delay	0	ns
SyncMode	0 (no time pulse in case of no fix)	

u-blox 5 Standard firmware versions

Standard FW version strings

Version	String
FW 6.00	EXT CORE 6.00 (33247) May 13 2009 17:35:46 ROM BASE x.xx (xxxxx) xxx xx xxxx xx:xx:xx
FW 5.00	ROM CORE 5.00 (28483) Jun 6 2008 14:45:11
	EXT CORE 5.00 (29857) Sep 18 2008 08:45:02 ROM BASE x.xx (xxxxx) xxx xx xxxx xx:xx:xx
	EXT CORE 5.00 (28483) Jun 6 2008 14:42:32 ROM BASE 4.00
	EXT CORE 5.00 (28483) Jun 6 2008 14:41:05 ROM BASE 0.30
FW 4.00	ROM CORE 4.00 (25682) Jan 14 2008 16:29:23
	EXT CORE 4.00 (25775) Jan 17 2008 13:21:05 ROM BASE 0.30

Geodetic Datum

Predefined Datum

The following, predefined Datum Values are available and can be configured using UBX message [CFG-DAT](#).

For the ellipsoid parameters, see [ellipsoid section](#) below. For the rotation and scale parameters, see [rotation and scale section](#) below.



The receiver defaults to WGS84 datum

Geodetic Datum Defined in Firmware

Index	Description	Short	Ellipsoid Index	Rotation, Scale	dX [m]	dY [m]	dZ [m]
0	World Geodetic System - 84	WGS84	0	0	0.0	0.0	0.0

Geodetic Datum Defined in Firmware continued

Index	Description	Short	Ellipsoid Index	Rotation, Scale	dX [m]	dY [m]	dZ [m]
1	World Geodetic System - 72	WGS72	23	1	0.0	0.0	4.5
2	Earth-90 - GLONASS Coordinate system	ETH90	8	0	0.0	0.0	4.0
3	Adindan - Mean Solution (Ethiopia & Sudan)	ADI-M	7	0	-166.0	-15.0	204.0
4	Adindan - Burkina Faso	ADI-E	7	0	-118.0	-14.0	218.0
5	Adindan - Cameroon	ADI-F	7	0	-134.0	-2.0	210.0
6	Adindan - Ethiopia	ADI-A	7	0	-165.0	-11.0	206.0
7	Adindan - Mali	ADI-C	7	0	-123.0	-20.0	220.0
8	Adindan - Senegal	ADI-D	7	0	-128.0	-18.0	224.0
9	Adindan - Sudan	ADI-B	7	0	-161.0	-14.0	205.0
10	Afgooye - Somalia	AFG	21	0	-43.0	-163.0	45.0
11	ARC 1950 - Mean (Botswana, Lesotho, Malawi, Swaziland, Zaire, Zambia, Zimbabwe)	ARF-M	7	0	-143.0	-90.0	-294.0
12	ARC 1950 - Botswana	ARF-A	7	0	-138.0	-105.0	-289.0
13	ARC 1950 - Burundi	ARF-H	7	0	-153.0	-5.0	-292.0
14	ARC 1950 - Lesotho	ARF-B	7	0	-125.0	-108.0	-295.0
15	ARC 1950 - Malawi	ARF-C	7	0	-161.0	-73.0	-317.0
16	ARC 1950 - Swaziland	ARF-D	7	0	-134.0	-105.0	-295.0
17	ARC 1950 - Zaire	ARF-E	7	0	-169.0	-19.0	-278.0
18	ARC 1950 - Zambia	ARF-F	7	0	-147.0	-74.0	-283.0
19	ARC 1950 - Zimbabwe	ARF-G	7	0	-142.0	-96.0	-293.0
20	ARC 1960 - Mean (Kenya, Tanzania)	ARS	7	0	-160.0	-6.0	-302.0
21	Ayabelle Lighthouse - Djibouti	PHA	7	0	-79.0	-129.0	145.0
22	Bissau - Guinea-Bissau	BID	20	0	-173.0	253.0	27.0
23	Cape - South Africa	CAP	7	0	-136.0	-108.0	-292.0
24	Carthage - Tunisia	CGE	7	0	-263.0	6.0	431.0
25	Dabola - Guinea	DAL	7	0	-83.0	37.0	124.0
26	Leigon - Ghana	LEH	7	0	-130.0	29.0	364.0
27	Liberia 1964	LIB	7	0	-90.0	40.0	88.0
28	Massawa - Eritrea (Ethiopia)	MAS	5	0	639.0	405.0	60.0
29	Merchich - Morocco	MER	7	0	31.0	146.0	47.0
30	Minna - Cameroon	MIN-A	7	0	-81.0	-84.0	115.0
31	Minna - Nigeria	MIN-B	7	0	-92.0	-93.0	122.0
32	M'Poraloko - Gabon	MPO	7	0	-74.0	-130.0	42.0
33	North Sahara 1959 - Algeria	NSD	7	0	-186.0	-93.0	310.0
34	Old Egyptian 1907 - Egypt	OEG	17	0	-130.0	110.0	-13.0
35	Point 58 - Mean Solution (Burkina Faso & Niger)	PTB	7	0	-106.0	-129.0	165.0
36	Pointe Noire 1948 - Congo	PTN	7	0	-148.0	51.0	-291.0
37	Schwarzeck - Namibia	SCK	5	0	616.0	97.0	-251.0
38	Voirol 1960 - Algeria	VOR	7	0	-123.0	-206.0	219.0
39	Ain El Abd 1970 - Bahrain Island	AIN-A	20	0	-150.0	-250.0	-1.0
40	Ain El Abd 1970 - Saudi Arabia	AIN-B	20	0	-143.0	-236.0	7.0
41	Djakarta (Batavia)- Sumatra (Indonesia)	BAT	5	0	-377.0	681.0	-50.0
42	Hong Kong 1963 - Hong Kong	HKD	20	0	-156.0	-271.0	-189.0
43	Hu-Tzu-Shan - Taiwan	HTN	20	0	-637.0	-549.0	-203.0
44	Indian - Bangladesh	IND-B	9	0	282.0	726.0	254.0

Geodetic Datum Defined in Firmware continued

Index	Description	Short	Ellipsoid Index	Rotation, Scale	dX [m]	dY [m]	dZ [m]
45	Indian - India & Nepal	IND-I	11	0	295.0	736.0	257.0
46	Indian 1954 - Thailand	INF-A	9	0	217.0	823.0	299.0
47	Indian 1960 - Vietnam (near 16N)	ING-A	9	0	198.0	881.0	317.0
48	Indian 1960 - Con Son Island (Vietnam)	ING-B	9	0	182.0	915.0	344.0
49	Indian 1975 - Thailand	INH-A	9	0	209.0	818.0	290.0
50	Indonesian 1974	IDN	19	0	-24.0	-15.0	5.0
51	Kandawala - Sri Lanka	KAN	9	0	-97.0	787.0	86.0
52	Kertau 1948 - West Malaysia & Singapore	KEA	13	0	-11.0	851.0	5.0
53	Nahrwan - Masirah Island (Oman)	NAH-A	7	0	-247.0	-148.0	369.0
54	Nahrwan - United Arab Emirates	NAH-B	7	0	-249.0	-156.0	381.0
55	Nahrwan - Saudi Arabia	NAH-C	7	0	-243.0	-192.0	477.0
56	Oman	FAH	7	0	-346.0	-1.0	224.0
57	Qatar National - Qatar	QAT	20	0	-128.0	-283.0	22.0
58	South Asia - Singapore	SOA	15	0	7.0	-10.0	-26.0
59	Timbalai 1948 - Brunei & East Malaysia (Sarawak & Sabah)	TIL	10	0	-679.0	669.0	-48.0
60	Tokyo - Mean Solution (Japan, Okinawa & South Korea)	TOY-M	5	0	-148.0	507.0	685.0
61	Tokyo - Japan	TOY-A	5	0	-148.0	507.0	685.0
62	Tokyo - Okinawa	TOY-C	5	0	-158.0	507.0	676.0
63	Tokyo - South Korea	TOY-B	5	0	-146.0	507.0	687.0
64	Australian Geodetic 1966 - Australia & Tasmania	AUA	3	0	-133.0	-48.0	148.0
65	Australian Geodetic 1984 - Australia & Tasmania	AUG	3	0	-134.0	-48.0	149.0
66	European 1950 - Mean (AU, B, DK, FN, F, G, GR, I, LUX, NL, N, P, E, S, CH)	EUR-M	20	0	-87.0	-98.0	-121.0
67	European 1950 - Western Europe (AU, DK, FR, G, NL, CH)	EUR-A	20	0	-87.0	-96.0	-120.0
68	European 1950 - Cyprus	EUR-E	20	0	-104.0	-101.0	-140.0
69	European 1950 - Egypt	EUR-F	20	0	-130.0	-117.0	-151.0
70	European 1950 - England, Wales, Scotland & Channel Islands	EUR-G	20	0	-86.0	-96.0	-120.0
71	European 1950 - England, Wales, Scotland & Ireland	EUR-K	20	0	-86.0	-96.0	-120.0
72	European 1950 - Greece	EUR-B	20	0	-84.0	-95.0	-130.0
73	European 1950 - Iran	EUR-H	20	0	-117.0	-132.0	-164.0
74	European 1950 - Italy - Sardinia	EUR-I	20	0	-97.0	-103.0	-120.0
75	European 1950 - Italy - Sicily	EUR-J	20	0	-97.0	-88.0	-135.0
76	European 1950 - Malta	EUR-L	20	0	-107.0	-88.0	-149.0
77	European 1950 - Norway & Finland	EUR-C	20	0	-87.0	-95.0	-120.0
78	European 1950 - Portugal & Spain	EUR-D	20	0	-84.0	-107.0	-120.0
79	European 1950 - Tunisia	EUR-T	20	0	-112.0	-77.0	-145.0
80	European 1979 - Mean Solution (AU, FN, NL, N, E, S, CH)	EUS	20	0	-86.0	-98.0	-119.0

Geodetic Datum Defined in Firmware continued

Index	Description	Short	Ellipsoid Index	Rotation, Scale	dX [m]	dY [m]	dZ [m]
81	Hjorsey 1955 - Iceland	HJO	20	0	-73.0	46.0	-86.0
82	Ireland 1965	IRL	2	0	506.0	-122.0	611.0
83	Ordnance Survey of GB 1936 - Mean (E, IoM, S, ShI, W)	OGB-M	1	0	375.0	-111.0	431.0
84	Ordnance Survey of GB 1936 - England	OGB-A	1	0	371.0	-112.0	434.0
85	Ordnance Survey of GB 1936 - England, Isle of Man & Wales	OGB-B	1	0	371.0	-111.0	434.0
86	Ordnance Survey of GB 1936 - Scotland & Shetland Isles	OGB-C	1	0	384.0	-111.0	425.0
87	Ordnance Survey of GB 1936 - Wales	OGB-D	1	0	370.0	-108.0	434.0
88	Rome 1940 - Sardinia Island	MOD	20	0	-225.0	-65.0	9.0
89	S-42 (Pulkovo 1942) - Hungary	SPK	21	0	28.0	-121.0	-77.0
90	S-JTSK Czechoslovakia (prior to 1 Jan 1993)	CCD	5	0	589.0	76.0	480.0
91	Cape Canaveral - Mean Solution (Florida & Bahamas)	CAC	6	0	-2.0	151.0	181.0
92	N. American 1927 - Mean Solution (CONUS)	NAS-C	6	0	-8.0	160.0	176.0
93	N. American 1927 - Western US	NAS-B	6	0	-8.0	159.0	175.0
94	N. American 1927 - Eastern US	NAS-A	6	0	-9.0	161.0	179.0
95	N. American 1927 - Alaska (excluding Aleutian Islands)	NAS-D	6	0	-5.0	135.0	172.0
96	N. American 1927 - Aleutian Islands, East of 180W	NAS-V	6	0	-2.0	152.0	149.0
97	N. American 1927 - Aleutian Islands, West of 180W	NAS-W	6	0	2.0	204.0	105.0
98	N. American 1927 - Bahamas (excluding San Salvador Island)	NAS-Q	6	0	-4.0	154.0	178.0
99	N. American 1927 - San Salvador Island	NAS-R	6	0	1.0	140.0	165.0
100	N. American 1927 - Canada Mean Solution (including Newfoundland)	NAS-E	6	0	-10.0	158.0	187.0
101	N. American 1927 - Alberta & British Columbia	NAS-F	6	0	-7.0	162.0	188.0
102	N. American 1927 - Eastern Canada (Newfoundland, New Brunswick, Nova Scotia & Quebec)	NAS-G	6	0	-22.0	160.0	190.0
103	N. American 1927 - Manitoba & Ontario	NAS-H	6	0	-9.0	157.0	184.0
104	N. American 1927 - Northwest Territories & Saskatchewan	NAS-I	6	0	4.0	159.0	188.0
105	N. American 1927 - Yukon	NAS-J	6	0	-7.0	139.0	181.0
106	N. American 1927 - Canal Zone	NAS-O	6	0	0.0	125.0	201.0
107	N. American 1927 - Caribbean	NAS-P	6	0	-3.0	142.0	183.0
108	N. American 1927 - Central America	NAS-N	6	0	0.0	125.0	194.0
109	N. American 1927 - Cuba	NAS-T	6	0	-9.0	152.0	178.0
110	N. American 1927 - Greenland (Hayes Peninsula)	NAS-U	6	0	11.0	114.0	195.0
111	N. American 1927 - Mexico	NAS-L	6	0	-12.0	130.0	190.0

Geodetic Datum Defined in Firmware continued

Index	Description	Short	Ellipsoid Index	Rotation, Scale	dX [m]	dY [m]	dZ [m]
112	N. American 1983 - Alaska (excluding Aleutian Islands)	NAR-A	16	0	0.0	0.0	0.0
113	N. American 1983 - Aleutian Islands	NAR-E	16	0	-2.0	0.0	4.0
114	N. American 1983 - Canada	NAR-B	16	0	0.0	0.0	0.0
115	N. American 1983 - Mean Solution (CONUS)	NAR-C	16	0	0.0	0.0	0.0
116	N. American 1983 - Hawaii	NAR-H	16	0	1.0	1.0	-1.0
117	N. American 1983 - Mexico & Central America	NAR-D	16	0	0.0	0.0	0.0
118	Bogota Observatory - Colombia	BOO	20	0	307.0	304.0	-318.0
119	Campo Inchauspe 1969 - Argentina	CAI	20	0	-148.0	136.0	90.0
120	Chua Astro - Paraguay	CHU	20	0	-134.0	229.0	-29.0
121	Corrego Alegre - Brazil	COA	20	0	-206.0	172.0	-6.0
122	Prov S. American 1956 - Mean Solution (Bol, Col, Ecu, Guy, Per & Ven)	PRP-M	20	0	-288.0	175.0	-376.0
123	Prov S. American 1956 - Bolivia	PRP-A	20	0	-270.0	188.0	-388.0
124	Prov S. American 1956 - Northern Chile (near 19S)	PRP-B	20	0	-270.0	183.0	-390.0
125	Prov S. American 1956 - Southern Chile (near 43S)	PRP-C	20	0	-305.0	243.0	-442.0
126	Prov S. American 1956 - Colombia	PRP-D	20	0	-282.0	169.0	-371.0
127	Prov S. American 1956 - Ecuador	PRP-E	20	0	-278.0	171.0	-367.0
128	Prov S. American 1956 - Guyana	PRP-F	20	0	-298.0	159.0	-369.0
129	Prov S. American 1956 - Peru	PRP-G	20	0	-279.0	175.0	-379.0
130	Prov S. American 1956 - Venezuela	PRP-H	20	0	-295.0	173.0	-371.0
131	Prov South Chilean 1963	HIT	20	0	16.0	196.0	93.0
132	South American 1969 - Mean Solution (Arg, Bol, Bra, Chi, Col, Ecu, Guy, Par, Per, Tri & Tob, Ven)	SAN-M	22	0	-57.0	1.0	-41.0
133	South American 1969 - Argentina	SAN-A	22	0	-62.0	-1.0	-37.0
134	South American 1969 - Bolivia	SAN-B	22	0	-61.0	2.0	-48.0
135	South American 1969 - Brazil	SAN-C	22	0	-60.0	-2.0	-41.0
136	South American 1969 - Chile	SAN-D	22	0	-75.0	-1.0	-44.0
137	South American 1969 - Colombia	SAN-E	22	0	-44.0	6.0	-36.0
138	South American 1969 - Ecuador (excluding Galapagos Islands)	SAN-F	22	0	-48.0	3.0	-44.0
139	South American 1969 - Baltra, Galapagos Islands	SAN-J	22	0	-47.0	26.0	-42.0
140	South American 1969 - Guyana	SAN-G	22	0	-53.0	3.0	-47.0
141	South American 1969 - Paraguay	SAN-H	22	0	-61.0	2.0	-33.0
142	South American 1969 - Peru	SAN-I	22	0	-58.0	0.0	-44.0
143	South American 1969 - Trinidad & Tobago	SAN-K	22	0	-45.0	12.0	-33.0
144	South American 1969 - Venezuela	SAN-L	22	0	-45.0	8.0	-33.0
145	Zanderij - Suriname	ZAN	20	0	-265.0	120.0	-358.0
146	Antigua Island Astro 1943 - Antigua, Leeward Islands	AIA	7	0	-270.0	13.0	62.0
147	Ascension Island 1958	ASC	20	0	-205.0	107.0	53.0

Geodetic Datum Defined in Firmware continued

Index	Description	Short	Ellipsoid Index	Rotation, Scale	dX [m]	dY [m]	dZ [m]
148	Astro Dos 71/4 - St Helena Island	SHB	20	0	-320.0	550.0	-494.0
149	Bermuda 1957 - Bermuda Islands	BER	6	0	-73.0	213.0	296.0
150	Deception Island, Antarctica	DID	7	0	260.0	12.0	-147.0
151	Fort Thomas 1955 - Nevis, St Kitts, Leeward Islands	FOT	7	0	-7.0	215.0	225.0
152	Graciosa Base SW 1948 - Faial, Graciosa, Pico, Sao Jorge, Terceira Islands (Azores)	GRA	20	0	-104.0	167.0	-38.0
153	ISTS 061 Astro 1968 - South Georgia Islands	ISG	20	0	-794.0	119.0	-298.0
154	L.C. 5 Astro 1961 - Cayman Brac Island	LCF	6	0	42.0	124.0	147.0
155	Montserrat Island Astro 1958 - Montserrat Leeward Islands	ASM	7	0	174.0	359.0	365.0
156	Naparima, BWI - Trinidad & Tobago	NAP	20	0	-10.0	375.0	165.0
157	Observatorio Meteorologico 1939 - Corvo and Flores Islands (Azores)	FLO	20	0	-425.0	-169.0	81.0
158	Pico De Las Nieves - Canary Islands	PLN	20	0	-307.0	-92.0	127.0
159	Porto Santo 1936 - Porto Santo and Madeira Islands	POS	20	0	-499.0	-249.0	314.0
160	Puerto Rico - Puerto Rico & Virgin Islands	PUR	6	0	11.0	72.0	-101.0
161	Qornoq - South Greenland	QUO	20	0	164.0	138.0	-189.0
162	Sao Braz - Soa Miguel, Santa Maria Islands (Azores)	SAO	20	0	-203.0	141.0	53.0
163	Sapper Hill 1943 - East Falkland Island	SAP	20	0	-355.0	21.0	72.0
164	Selvagem Grande 1938 - Salvage Islands	SGM	20	0	-289.0	-124.0	60.0
165	Tristan Astro 1968 - Tristan du Cunha	TDC	20	0	-632.0	438.0	-609.0
166	Anna 1 Astro 1965 - Cocos Islands	ANO	3	0	-491.0	-22.0	435.0
167	Gandajika Base 1970 - Republic of Maldives	GAA	20	0	-133.0	-321.0	50.0
168	ISTS 073 Astro 1969 - Diego Garcia	IST	20	0	208.0	-435.0	-229.0
169	Kerguelen Island 1949 - Kerguelen Island	KEG	20	0	145.0	-187.0	103.0
170	Mahe 1971 - Mahe Island	MIK	7	0	41.0	-220.0	-134.0
171	Reunion - Mascarene Islands	RUE	20	0	94.0	-948.0	-1262.0
172	American Samoa 1962 - American Samoa Islands	AMA	6	0	-115.0	118.0	426.0
173	Astro Beacon E 1945 - Iwo Jima	ATF	20	0	145.0	75.0	-272.0
174	Astro Tern Island (Frig) 1961 - Tern Island	TRN	20	0	114.0	-116.0	-333.0
175	Astronomical Station 1952 - Marcus Island	ASQ	20	0	124.0	-234.0	-25.0
176	Bellevue (IGN) - Efate and Erromango Islands	IBE	20	0	-127.0	-769.0	472.0
177	Canton Astro 1966 - Phoenix Islands	CAO	20	0	298.0	-304.0	-375.0
178	Chatham Island Astro 1971 - Chatham Island (New Zeland)	CHI	20	0	175.0	-38.0	113.0
179	DOS 1968 - Gizo Island (New Georgia Islands)	GIZ	20	0	230.0	-199.0	-752.0
180	Easter Island 1967 - Easter Island	EAS	20	0	211.0	147.0	111.0
181	Geodetic Datum 1949 - New Zealand	GEO	20	0	84.0	-22.0	209.0
182	Guam 1963 - Guam Island	GUA	6	0	-100.0	-248.0	259.0
183	GUX 1 Astro - Guadalcanal Island	DOB	20	0	252.0	-209.0	-751.0
184	Indonesian 1974 - Indonesia	IDN	19	0	-24.0	-15.0	5.0

Geodetic Datum Defined in Firmware continued

Index	Description	Short	Ellipsoid Index	Rotation, Scale	dX [m]	dY [m]	dZ [m]
185	Johnston Island 1961 - Johnston Island	JOH	20	0	189.0	-79.0	-202.0
186	Kusaie Astro 1951 - Caroline Islands, Fed. States of Micronesia	KUS	20	0	647.0	1777.0	-1124.0
187	Luzon - Philippines (excluding Mindanao Island)	LUZ-A	6	0	-133.0	-77.0	-51.0
188	Luzon - Mindanao Island (Philippines)	LUZ-B	6	0	-133.0	-79.0	-72.0
189	Midway Astro 1961 - Midway Islands	MID	20	0	912.0	-58.0	1227.0
190	Old Hawaiian - Mean Solution	OHA-M	6	0	61.0	-285.0	-181.0
191	Old Hawaiian - Hawaii	OHA-A	6	0	89.0	-279.0	-183.0
192	Old Hawaiian - Kauai	OHA-B	6	0	45.0	-290.0	-172.0
193	Old Hawaiian - Maui	OHA-C	6	0	65.0	-290.0	-190.0
194	Old Hawaiian - Oahu	OHA-D	6	0	58.0	-283.0	-182.0
195	Pitcairn Astro 1967 - Pitcairn Island	PIT	20	0	185.0	165.0	42.0
196	Santo (Dos) 1965 - Espirito Santo Island	SAE	20	0	170.0	42.0	84.0
197	Viti Levu 1916 - Viti Levu Island (Fiji Islands)	MVS	7	0	51.0	391.0	-36.0
198	Wake-Eniwetok 1960 - Marshall Islands	ENW	18	0	102.0	52.0	-38.0
199	Wake Island Astro 1952 - Wake Atoll	WAK	20	0	276.0	-57.0	149.0
200	Bukit Rimpah - Bangka and Belitung Islands (Indonesia)	BUR	5	0	-384.0	664.0	-48.0
201	Camp Area Astro - Camp McMurdo Area, Antarctica	CAZ	20	0	-104.0	-129.0	239.0
202	European 1950 - Iraq, Israel, Jordan, Kuwait, Lebanon, Saudi Arabia & Syria	EUR-S	20	0	-103.0	-106.0	-141.0
203	Gunung Segara - Kalimantan (Indonesia)	GSE	5	0	-403.0	684.0	41.0
204	Herat North - Afghanistan	HEN	20	0	-333.0	-222.0	114.0
205	Indian - Pakistan	IND-P	9	0	283.0	682.0	231.0
206	Pulkovo 1942 - Russia	PUK	21	0	28.0	-130.0	-95.0
207	Tananarive Observatory 1925 - Madagascar	TAN	20	0	-189.0	-242.0	-91.0
208	Yacare - Uruguay	YAC	20	0	-155.0	171.0	37.0
209	Krassovsky 1942 - Russia	KRA42	21	0	26.0	-139.0	-80.0
210	Lommel Datum 1950 - Belgium & Luxembourg	BLG50	20	0	-55.0	49.0	-158.0
211	Reseau National Belge 1972 - Belgium	RNB72	20	0	-104.0	80.0	-75.0
212	NTF - Nouvelle Triangulation de la France	NTF	7	0	-168.0	-60.0	320.0
213	Netherlands 1921 - Netherlands	NL21	5	0	719.0	47.0	640.0
214	European Datum 1987, IAG RETrig Subcommision.	ED87	20	2	-82.5	-91.7	-117.7
215	Swiss Datum 1903+ (LV95)	CH95	5	0	674.374	15.056	405.346

Ellipsoids

Ellipsoids

Index	Description	Semi Major Axis [m]	Flattening
0	WGS 84	6378137.000	298.257223563
1	Airy 1830	6377563.396	299.3249646
2	Modified Airy	6377340.189	299.3249646

Ellipsoids continued

Index	Description	Semi Major Axis [m]	Flattening
3	Australian National	6378160.000	298.25
4	Bessel 1841 (Namibia)	6377483.865	299.1528128
5	Bessel 1841	6377397.155	299.1528128
6	Clarke 1866	6378206.400	294.9786982
7	Clarke 1880	6378249.145	293.465
8	Earth-90	6378136.000	298.257839303
9	Everest (India 1830)	6377276.345	300.8017
10	Everest (Sabah Sarawak)	6377298.556	300.8017
11	Everest (India 1956)	6377301.243	300.8017
12	Everest (Malaysia 1969)	6377295.664	300.8017
13	Everest (Malay. & Singapore 1948)	6377304.063	300.8017
14	Everest (Pakistan)	6377309.613	300.8017
15	Modified Fischer 1960	6378155.000	298.3
16	GRS 80	6378137.000	298.257222101
17	Helmert 1906	6378200.000	298.3
18	Hough 1960	6378270.000	297.0
19	Indonesian 1974	6378160.000	298.247
20	International 1924	6378388.000	297.0
21	Krassovsky 1940	6378245.000	298.3
22	South American 1969	6378160.000	298.25
23	WGS 72	6378135.000	298.26

Rotation and Scale

Rotation and Scale

Index	Description	Rot X [seconds]	Rot Y [seconds]	Rot Z [seconds]	Scale
0		+0.0000	+0.0000	+0.0000	0.000
1		+0.0000	+0.0000	-0.5540	0.220
2	European Datum 1987 IAG RETrig Subcommision.	+0.1338	-0.0625	-0.0470	0.045