

DATA SHEET

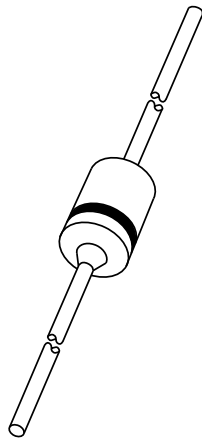

BYD71 series Ultra fast low-loss controlled avalanche rectifiers

Product specification
Supersedes data of 1996 May 24
File under Discrete Semiconductors, SC01

1996 Sep 19

Ultra fast low-loss controlled avalanche rectifiers

BYD71 series

FEATURES

- Glass passivated
- High maximum operating temperature
- Low leakage current
- Excellent stability
- Guaranteed avalanche energy absorption capability
- Available in ammo-pack.

DESCRIPTION

Cavity free cylindrical SOD91 glass package through Implotec™(1) technology. This package is

hermetically sealed and fatigue free as coefficients of expansion of all used parts are matched.

(1) Implotec is a trademark of Philips.

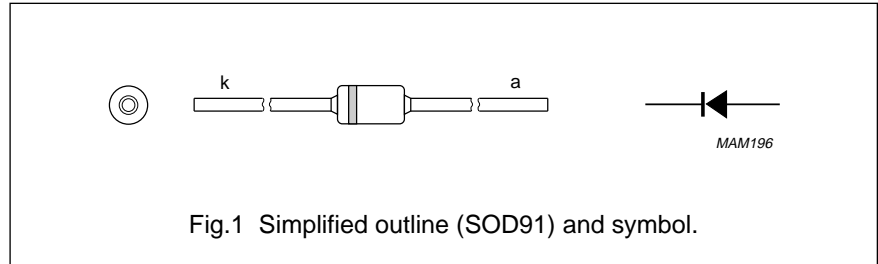

LIMITING VALUES

In accordance with the Absolute Maximum Rating System (IEC 134).

SYMBOL	PARAMETER	CONDITIONS	MIN.	MAX.	UNIT
V _{RRM}	repetitive peak reverse voltage				
	BYD71A		–	50	V
	BYD71B		–	100	V
	BYD71C		–	150	V
	BYD71D		–	200	V
	BYD71E		–	250	V
	BYD71F		–	300	V
	BYD71G		–	400	V
V _R	continuous reverse voltage				
	BYD71A		–	50	V
	BYD71B		–	100	V
	BYD71C		–	150	V
	BYD71D		–	200	V
	BYD71E		–	250	V
	BYD71F		–	300	V
	BYD71G		–	400	V
I _{F(AV)}	average forward current	T _{tp} = 55 °C; lead length = 10 mm; see Figs 2 and 3;	–	0.56	A
	BYD71A to D	averaged over any 20 ms period; see also Figs 10 and 11	–	0.54	A
I _{F(AV)}	average forward current	T _{amb} = 60 °C; PCB mounting (see Fig.16); see Figs 4 and 5;	–	0.43	A
	BYD71A to D	averaged over any 20 ms period; see also Figs 10 and 11	–	0.41	A
	BYD71E to G				

FOR REPLACEMENT TYPE SEE INDEX SECTION OF HANDBOOK SC01

Ultra fast low-loss controlled avalanche rectifiers

BYD71 series

SYMBOL	PARAMETER	CONDITIONS	MIN.	MAX.	UNIT
I_{FRM}	repetitive peak forward current	$T_{tp} = 55\text{ °C}$; see Figs 6 and 7	–	4.7	A
	BYD71A to D			5.0	
I_{FRM}	repetitive peak forward current	$T_{amb} = 60\text{ °C}$; see Figs 8 and 9	–	3.7	A
	BYD71E to G			3.9	
I_{FSM}	non-repetitive peak forward current	$t = 10\text{ ms}$ half sine wave; $T_j = T_{j,max}$ prior to surge; $V_R = V_{RRMmax}$	–	7	A
P_{RSM}	non-repetitive peak reverse power dissipation	$t = 20\text{ }\mu\text{s}$ half sine wave; $T_j = T_{j,max}$ prior to surge	–	250	W
	BYD71A to D			150	
T_{stg}	storage temperature		–65	+175	°C
T_j	junction temperature		–65	+175	°C

ELECTRICAL CHARACTERISTICS

$T_j = 25\text{ °C}$ unless otherwise specified.

SYMBOL	PARAMETER	CONDITIONS	MIN.	TYP.	MAX.	UNIT	
V_F	forward voltage	$I_F = 0.5\text{ A}$; $T_j = T_{j,max}$; see Figs 12 and 13	–	–	0.84	V	
	BYD71A to D				0.90		
V_F	forward voltage	$I_F = 0.5\text{ A}$; see Figs 12 and 13	–	–	1.05	V	
	BYD71E to G				1.11		
$V_{(BR)R}$	reverse avalanche breakdown voltage	$I_R = 0.1\text{ mA}$				V	
	BYD71A						55
	BYD71B						110
	BYD71C						165
	BYD71D						220
	BYD71E						275
	BYD71F						330
BYD71G	440						
I_R	reverse current	$V_R = V_{RRMmax}$; see Fig 14	–	–	1	μA	
		$V_R = V_{RRMmax}$; $T_j = 165\text{ °C}$; see Fig 14	–	–	75	μA	
t_{rr}	reverse recovery time	when switched from $I_F = 0.5\text{ A}$ to $I_R = 1\text{ A}$; measured at $I_R = 0.25\text{ A}$ see Fig 18	–	–	25	ns	
	BYD71A to D				50		
	BYD71E to G						

Ultra fast low-loss controlled avalanche rectifiers

BYD71 series

SYMBOL	PARAMETER	CONDITIONS	MIN.	TYP.	MAX.	UNIT
C _d	diode capacitance	f = 1 MHz; V _R = 0 V; see Fig.15	–	25	–	pF
	BYD71A to D					
	BYD71E to G		–	20	–	pF
$\left \frac{dI_R}{dt} \right $	maximum slope of reverse recovery current	when switched from I _F = 1 A to V _R ≥ 30 V and dI _F /dt = –1 A/μs; see Fig.17	–	–	4	A/μs
	BYD71A to D					
	BYD71E to G		–	–	5	A/μs

THERMAL CHARACTERISTICS

SYMBOL	PARAMETER	CONDITIONS	VALUE	UNIT
R _{th j-tp}	thermal resistance from junction to tie-point	lead length = 10 mm	180	K/W
R _{th j-a}	thermal resistance from junction to ambient	note 1	250	K/W

Note

1. Device mounted on an epoxy-glass printed-circuit board, 1.5 mm thick; thickness of Cu-layer ≥40 μm, see Fig.16. For more information please refer to the 'General Part of Handbook SC01'.

Ultra fast low-loss
controlled avalanche rectifiers

BYD71 series

GRAPHICAL DATA

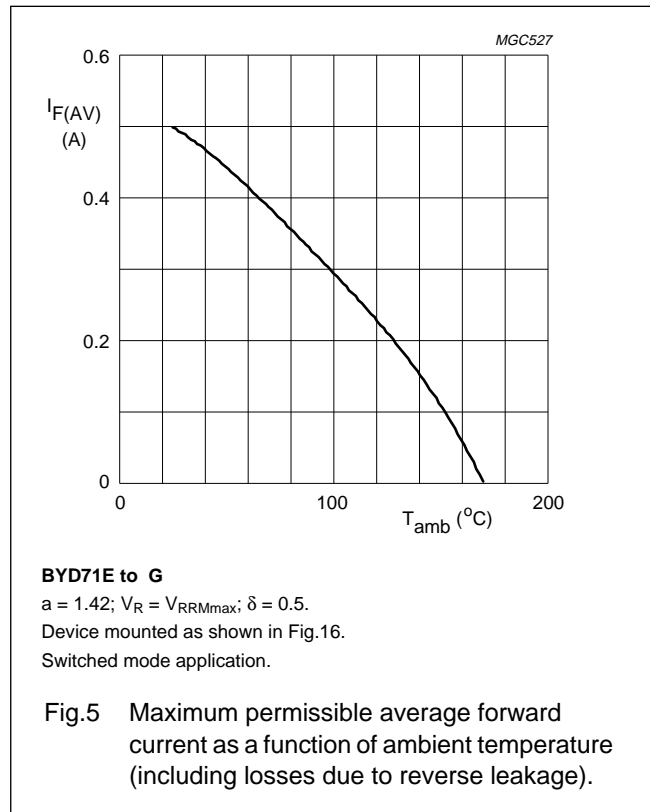
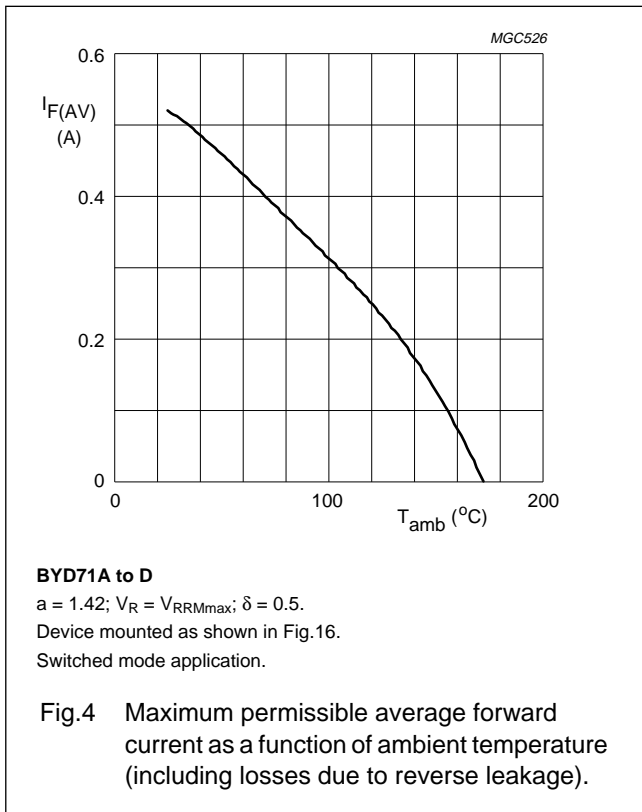
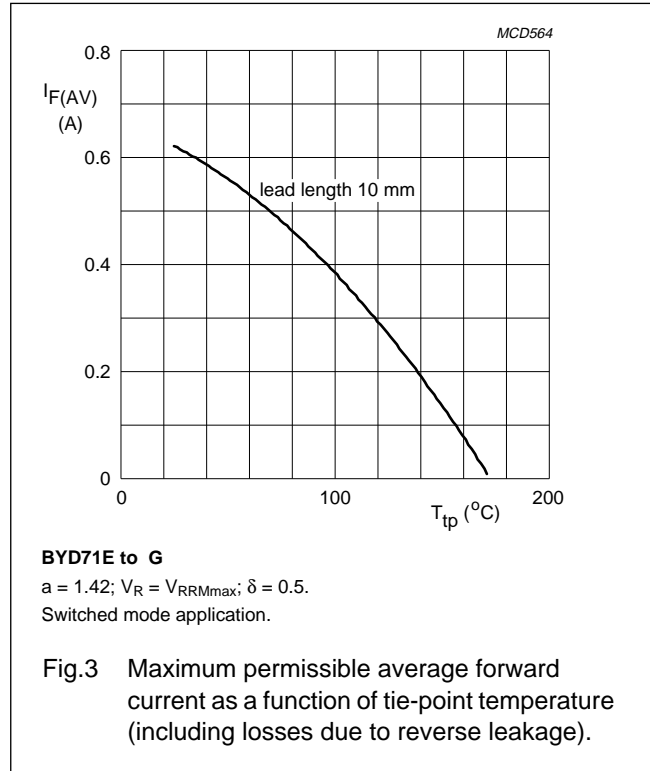
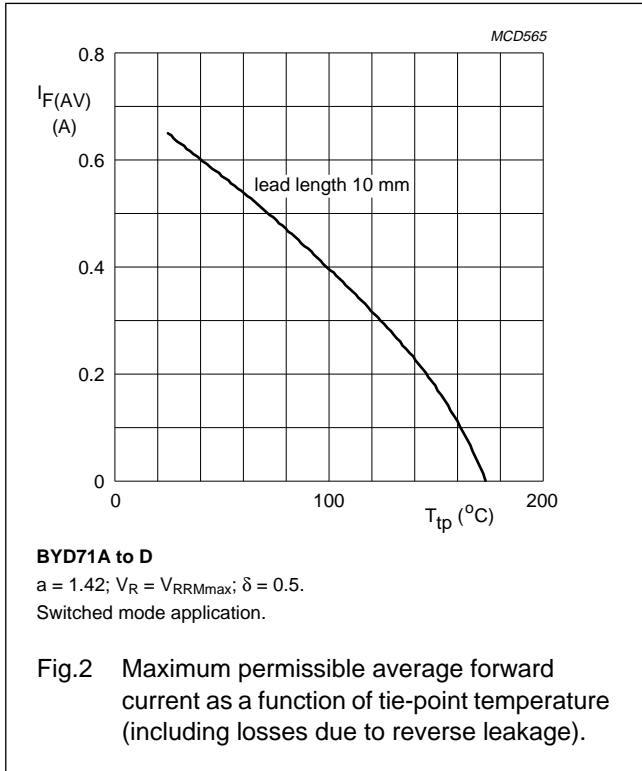

Ultra fast low-loss
controlled avalanche rectifiers

BYD71 series

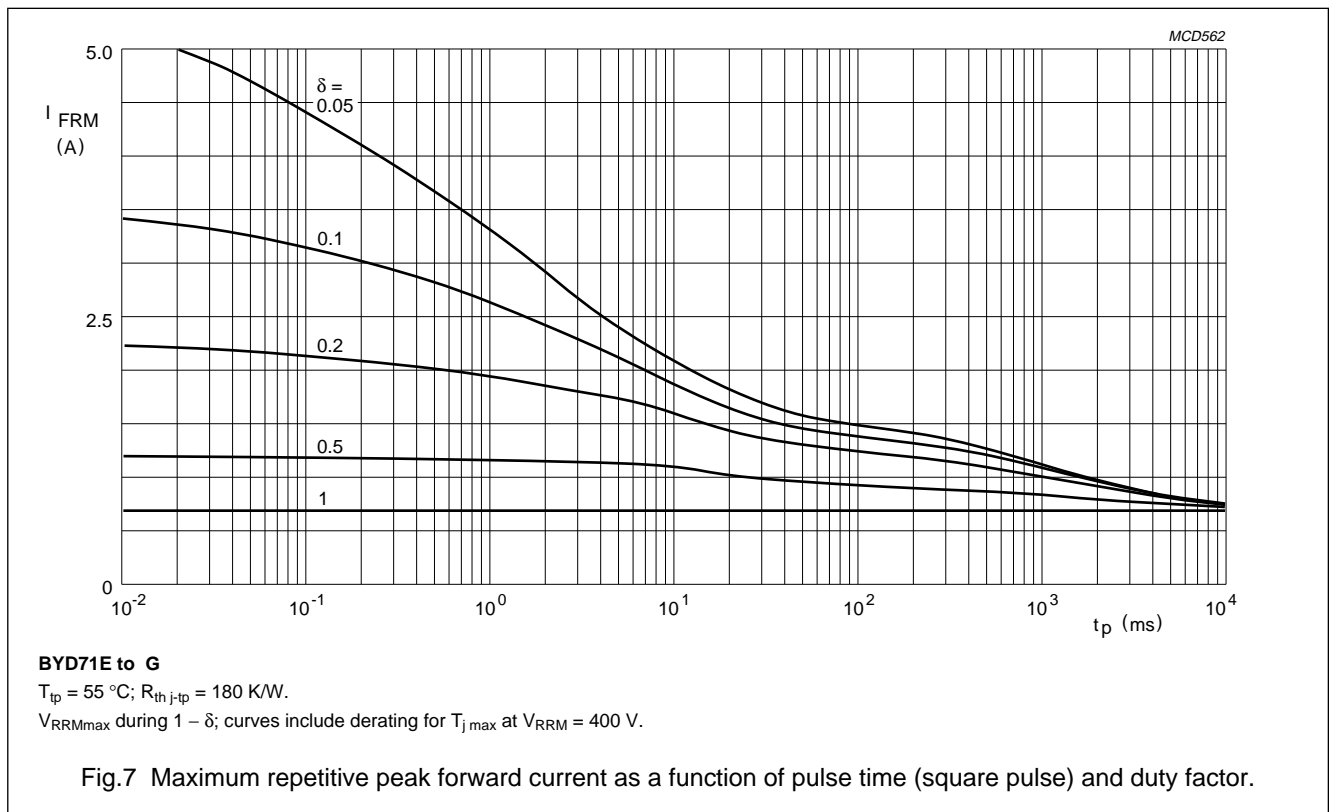
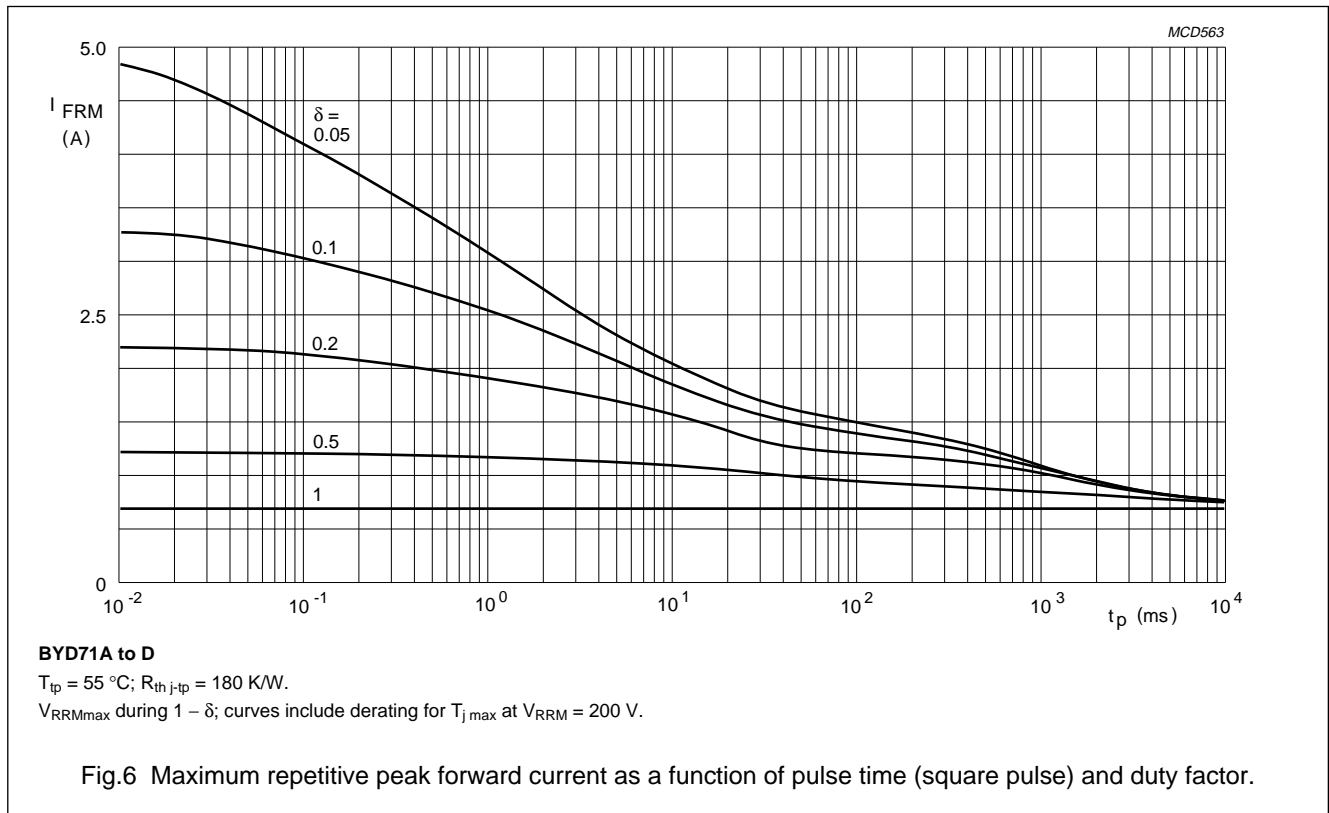

Ultra fast low-loss controlled avalanche rectifiers

BYD71 series

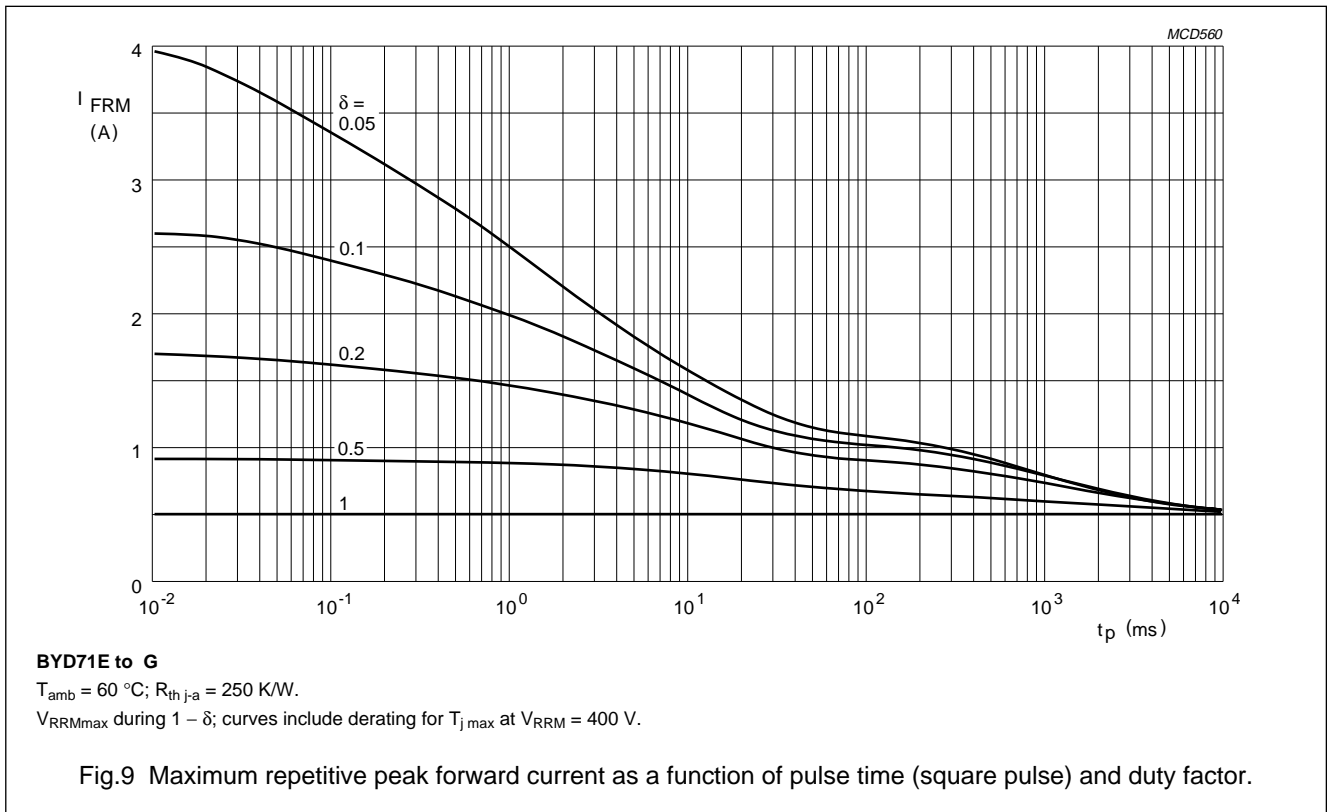
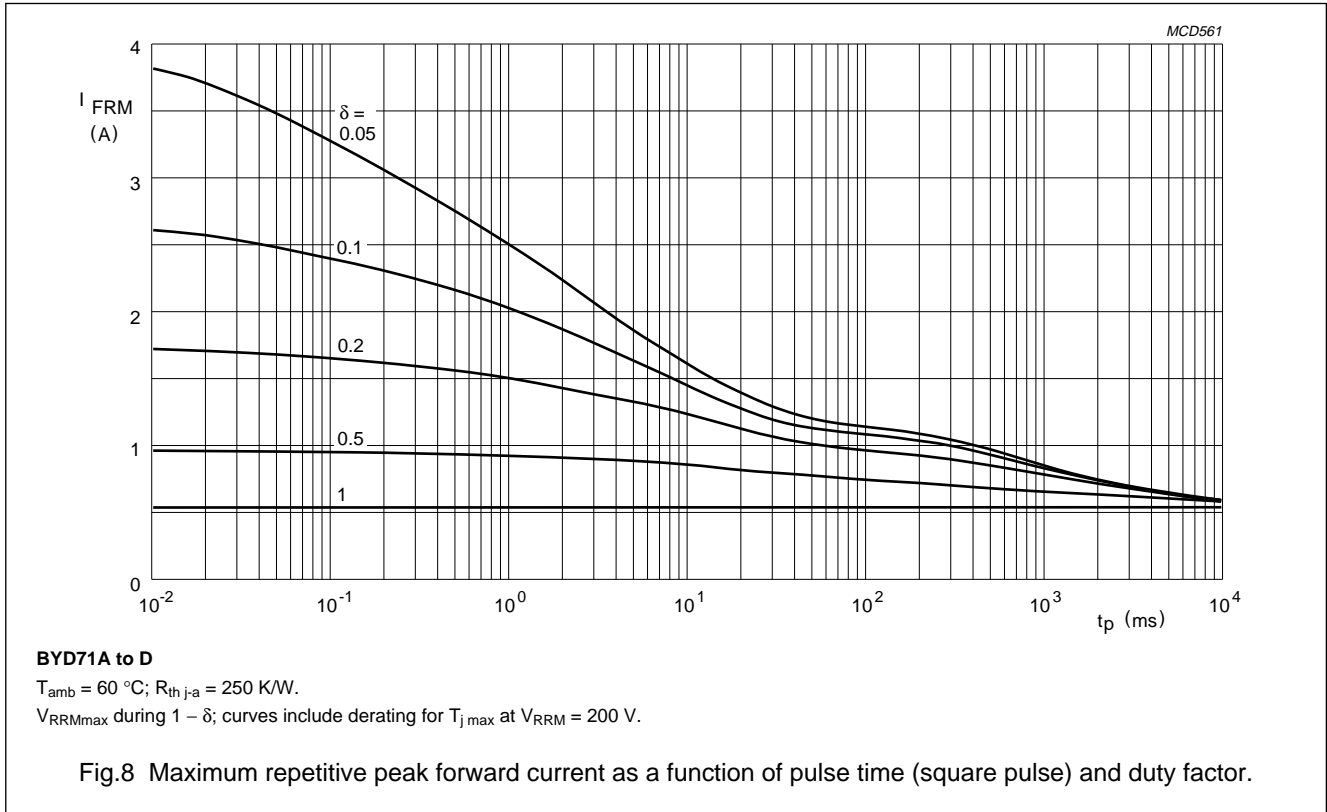

Ultra fast low-loss
controlled avalanche rectifiers

BYD71 series

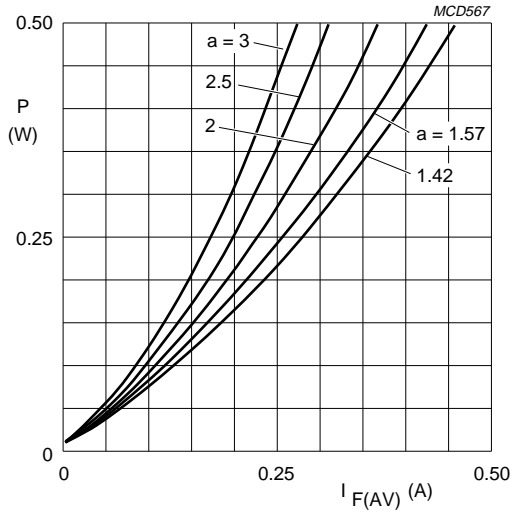

BYD71A to D

$a = I_{F(RMS)}/I_{F(AV)}$; $V_R = V_{RRMmax}$; $\delta = 0.5$.

Fig.10 Maximum steady state power dissipation (forward plus leakage current losses, excluding switching losses) as a function of average forward current.

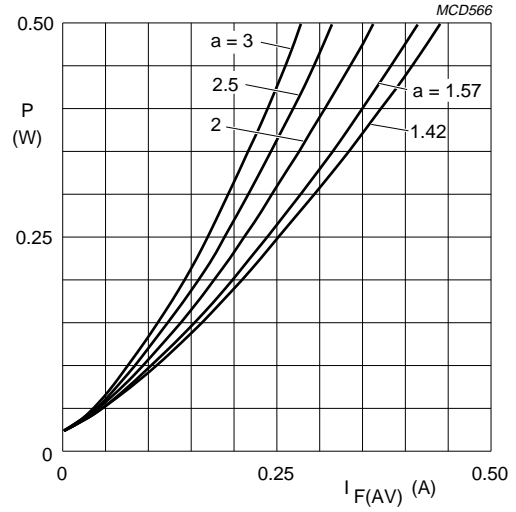

BYD71E to G

$a = I_{F(RMS)}/I_{F(AV)}$; $V_R = V_{RRMmax}$; $\delta = 0.5$.

Fig.11 Maximum steady state power dissipation (forward plus leakage current losses, excluding switching losses) as a function of average forward current.

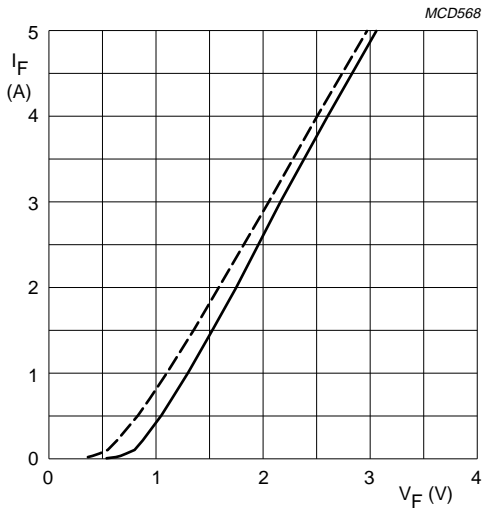

BYD71A to D

Dotted line: $T_j = 175 \text{ }^\circ\text{C}$.
Solid line: $T_j = 25 \text{ }^\circ\text{C}$.

Fig.12 Forward current as a function of forward voltage; maximum values.

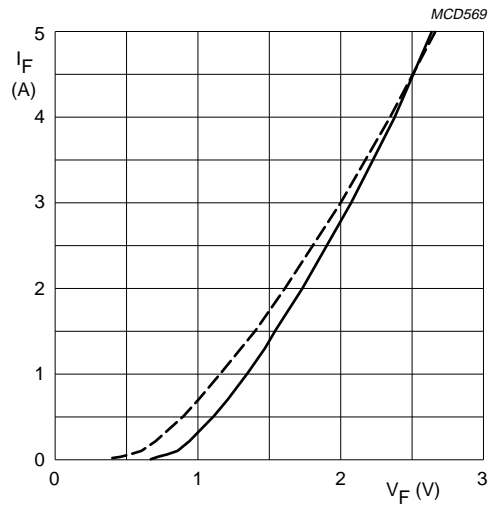

BYD71E to G

Dotted line: $T_j = 175 \text{ }^\circ\text{C}$.
Solid line: $T_j = 25 \text{ }^\circ\text{C}$.

Fig.13 Forward current as a function of forward voltage; maximum values.

Ultra fast low-loss
controlled avalanche rectifiers

BYD71 series

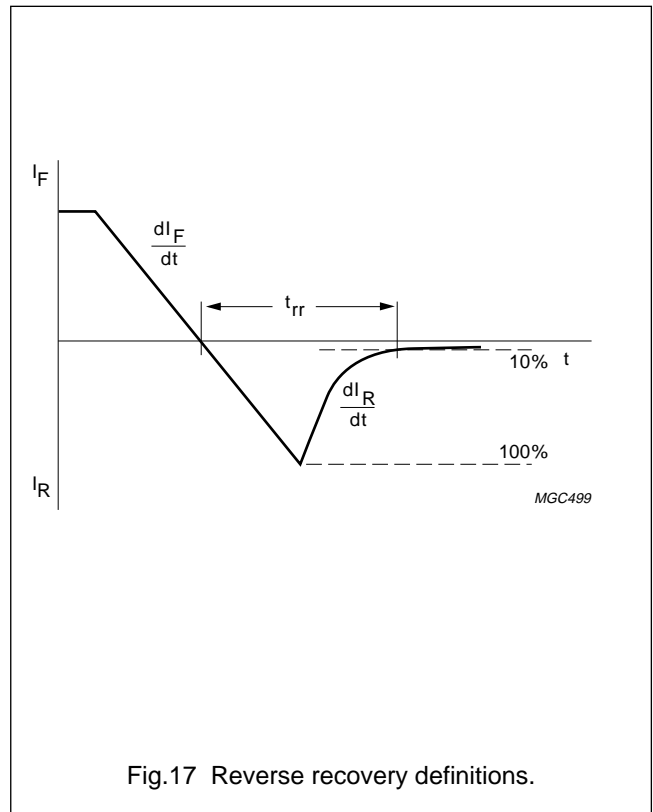
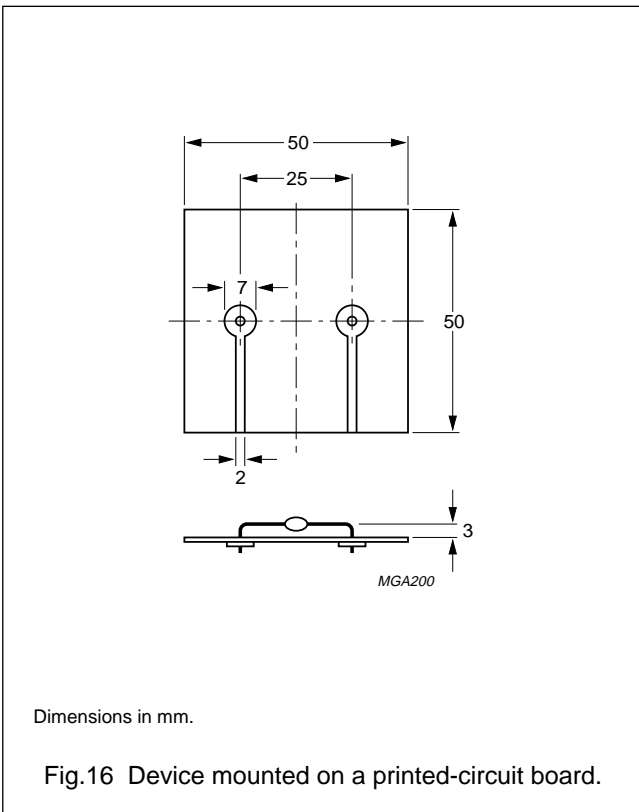
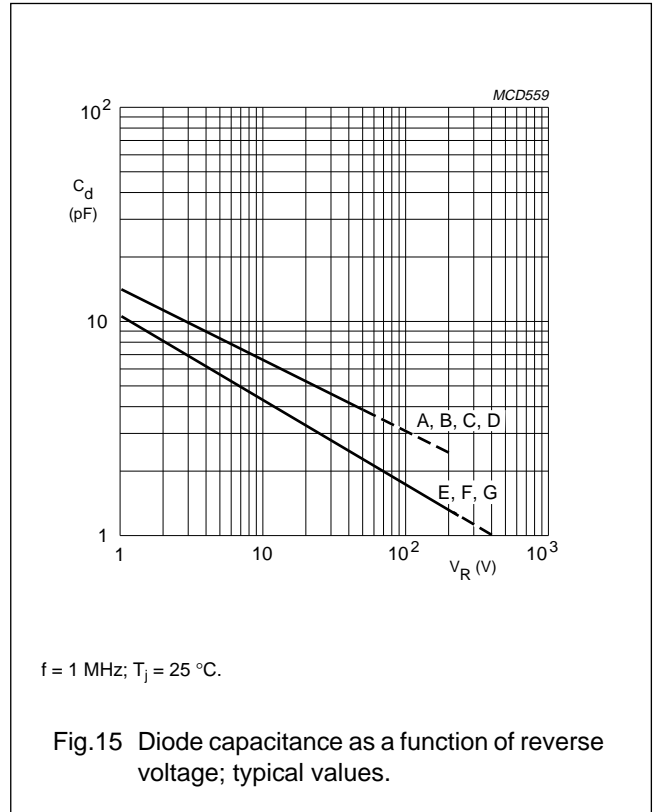
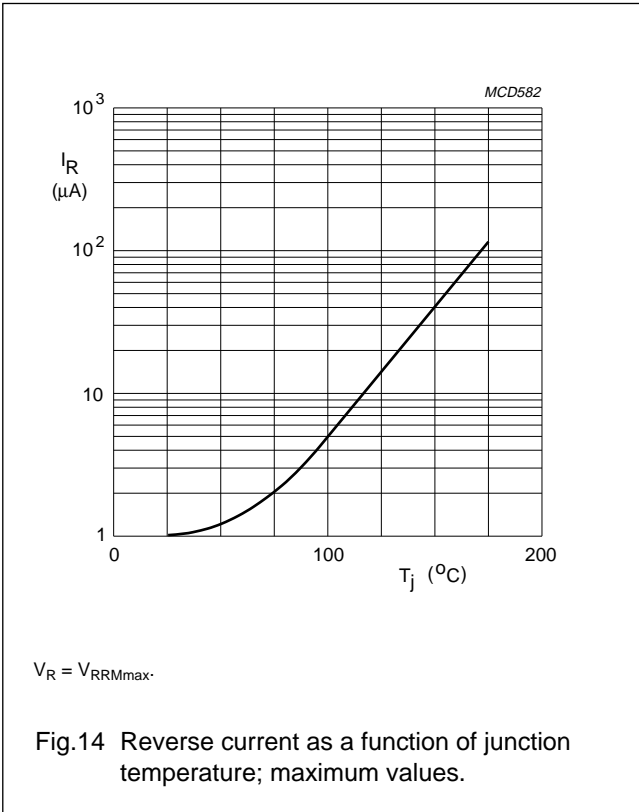

Ultra fast low-loss controlled avalanche rectifiers

BYD71 series

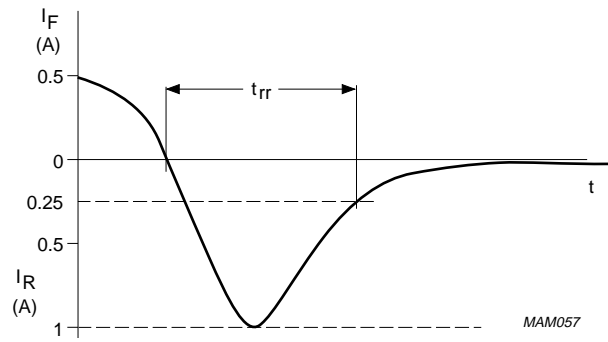
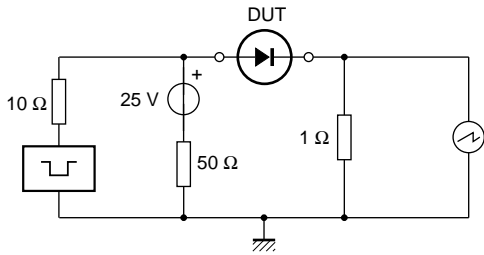

Input impedance oscilloscope: 1 MΩ, 22 pF; $t_r \leq 7$ ns.
Source impedance: 50 Ω; $t_r \leq 15$ ns.

Fig.18 Test circuit and reverse recovery time waveform and definition.

Ultra fast low-loss
controlled avalanche rectifiers

BYD71 series

PACKAGE OUTLINE

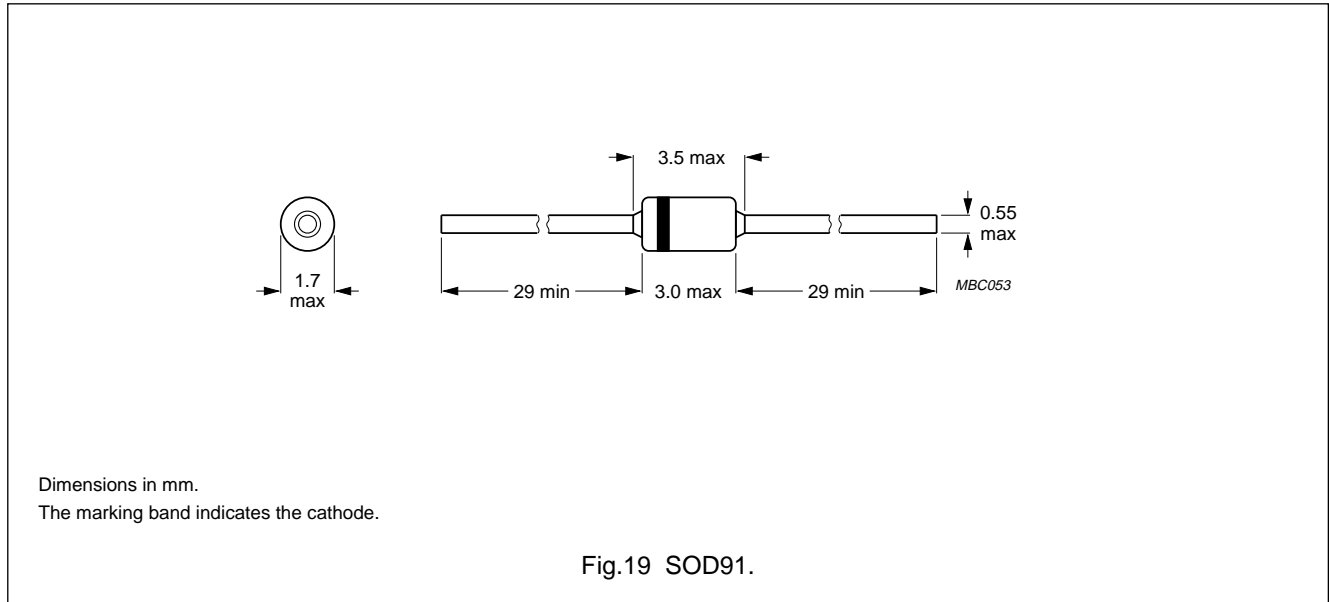

DEFINITIONS

Data Sheet Status	
Objective specification	This data sheet contains target or goal specifications for product development.
Preliminary specification	This data sheet contains preliminary data; supplementary data may be published later.
Product specification	This data sheet contains final product specifications.
Limiting values	
Limiting values given are in accordance with the Absolute Maximum Rating System (IEC 134). Stress above one or more of the limiting values may cause permanent damage to the device. These are stress ratings only and operation of the device at these or at any other conditions above those given in the Characteristics sections of the specification is not implied. Exposure to limiting values for extended periods may affect device reliability.	
Application information	
Where application information is given, it is advisory and does not form part of the specification.	

LIFE SUPPORT APPLICATIONS

These products are not designed for use in life support appliances, devices, or systems where malfunction of these products can reasonably be expected to result in personal injury. Philips customers using or selling these products for use in such applications do so at their own risk and agree to fully indemnify Philips for any damages resulting from such improper use or sale.