

## FRONTEND 4062 FY5

**3X 8501**

**3X 9957**

## TARGET - SPECIFICATION ELECTRICAL DATA

### 1. Description:

The frontend 4062 FY5 is specially designed for multimedia applications. Reception standard is Pal I . The frontend includes a hyperband tuner which covers the frequency range from 45 to 860 MHz and an IF-part with SAW-filter, IF-amplifier, video and sound demodulator. So the CVBS signal is available at the video output terminal, the audio signal at the audio output terminal. Also a 2nd IF output is provided, which allows external sound demodulation for NICAM reception.

The reception frequency range is divided in VHF low, VHF high and UHF. Bandselection and tuning is done via I<sup>2</sup>C-bus, completely.

Also a digital AFC-function can be realized, because the AFC-voltage, generated by the IF-demodulator is fed to an analog/digital converter which is included in the PLL-IC and readable via I<sup>2</sup>C-bus.

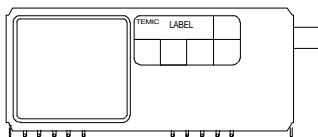
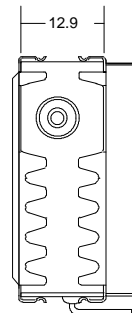
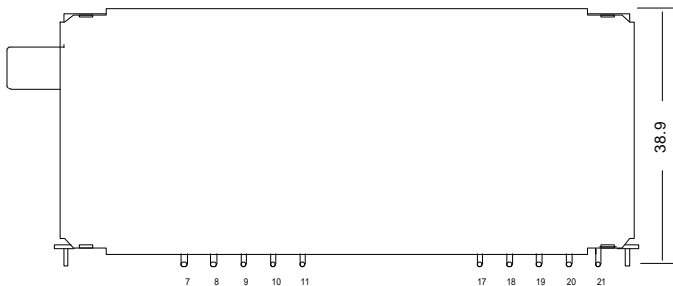
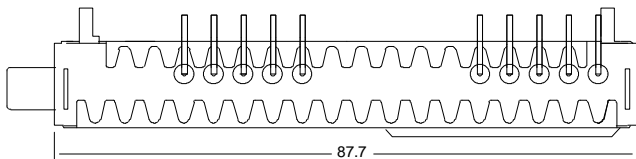

PIN	
4	
5	
6	
7	SUPPLY VOLTAGE VS2 33V
8	SUPPLY VOLTAGE VS1 FOR TUNER 5V
9	IIC BUS SIGNAL SCL
10	IIC BUS SIGNAL SDA
11	ADDRESS SELECTION FOR IIC BUS
12	
13	
14	
15	
16	
17	NOT CONNECTED
18	2nd IF
19	VIDEO OUTPUT CVBS
20	SUPPLY VOLTAGE VS1 FOR IF PART 5V
21	AF1 SOUND OUTPUT

### 2. Mechanical Characteristics:

#### 2.1. Dimensions:

according drawing 3X 8501GZ

#### 2.2. Weight: ca. 51 g

## 2.3. Types

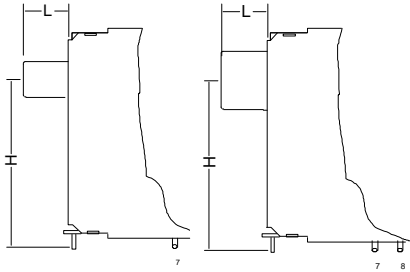

Tunertyp	3X 8501	3X 9957
Sockettyp	MINI PHONO	IEC
Socketlength	8.5 mm	14.0 mm
Height	29.1 mm	29.1 mm

## 3. Working Data:

### 3.1. Reception Standard:

Pal I

### 3.2. Frequency Range:

VHF low	ch A ... S 6	45.75 MHz ... 140.25 MHz
VHF high	ch S 7 ... S 41	147.25 MHz ... 463.25 MHz
UHF	ch 21 ... E 69	471.25 MHz ... 855.25 MHz

### Margin:

VHF low	ch A ... S 6	-0.5 MHz / +1 MHz
VHF high	ch S 7 ... S 41	-7 MHz / +2 MHz
UHF	ch 21 ... E 69	-8 MHz / +3 MHz

### Recommended take over frequencies:

VHF low / VHF high	144 MHz
VHF high / UHF	467 MHz

Frequency referred to channel center.

### IF:

picture carrier:	38.90 MHz
sound carrier :	32.90 MHz
NICAM sound carrier:	32.35 MHz

Oscillator operates above received frequency.

### 3.3. Supply voltage:

Supply voltage $V_{S1}$	5 V +/- 5%	max. 200 mA
Supply voltage $V_{S2}$	33V +/- 5%	max. 1.7 mA

### 3.4. Input impedance:

VHF/UHF common	75 $\Omega$ , unbalanced
----------------	--------------------------

### 3.5. Temperature:

(measured in slowly moved air)

Operating temperature:	0 ... 60 °C
Storage temperature:	-25 ... 60 °C

## 4. Test conditions:

If not otherwise noticed all data are hold under following conditions:

Measurement tolerance:	10 % or 1 dB
Ambient temperature:	25 °C +/- 3°
Supply voltages:	$V_{S1}, V_{S2}$ +/- 5%

## 5. Tuner Data:

### 5.1. Voltage Gain:

Voltage gain is measured between antenna input and IF1-Mp and IF2-Mp.  
For this measurement the input is loaded with 75 $\Omega$ , the output is loaded with a test circuit according diagram.

	min.	typ.	max.	unit
ch A ... ch 69	40		52	dB

### 5.2. Noise Figure:

VHF low	8.0	dB
VHF high	8.0	dB
UHF	10.0	dB

### 5.3. VSWR:

VHF low	4.0
VHF high	4.0
UHF	4.0

Referred to channel center frequency.

### 5.4. AGC-Range:

	min.	typ.	max.	unit
VHF low	50			dB
VHF high	45			dB
UHF	40			dB

### 5.5. IF-Rejection:

	min.	typ.	max.	unit
VHF low	50			dB
VHF high	60			dB
UHF	60			dB

### 5.6. Image-Rejection:

	min.	typ.	max.	unit
ch A ... ch S 6	60			dB
ch S 7 ... ch S 20	60			dB
ch S 21... ch S 41	60			dB
ch 21 ... ch E 69	53			dB

### 5.7. RF Tilt:

The amplitude difference between top of frequency response curve and any frequency between picture and sound carrier will not exceed 4 dB at nominal gain.

### 5.8. Test circuit for voltage gain:

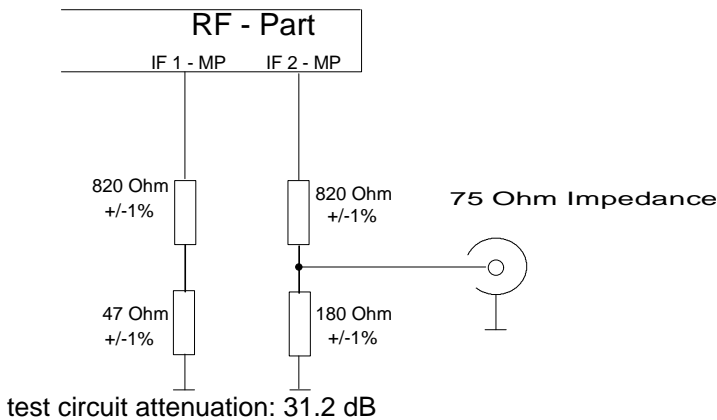

## 5.9. Test circuit for noise figure:

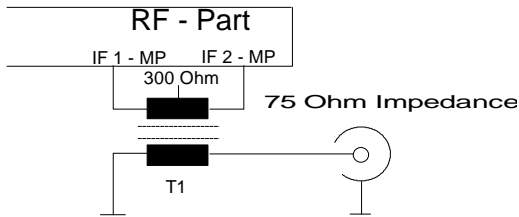

## 6. Output parameter:

### 6.1. Video output:

Output signal type: CVBS

Conditions:	Testsignal	min.	typ.	max.	unit
Ant. input level 66 dB $\mu$ V 20% residual carrier					
CVBS - Output level:		1.5	1.8	2.1	V (p-p)
Sync bottom dc level:			1.35		V
Load impedance		1			k $\Omega$
Load capacitance				20	pF
Video S/N (unweighted):					
	Black burst				
VHF		43			dB
UHF (70dB $\mu$ V input level)	43			dB	
Frequency response:	(sin x)/x				
Ref.: 0.2 MHz					
1 MHz		-1.0		1.5	dB
2 MHz		-1.5		2.0	dB
3 MHz		-2.5		2.0	dB
4 MHz		-3.5		1.0	dB
4.43 MHz		-7.0		-1.0	dB
5 MHz			-12		dB
Differential gain	Modulated 5 step staircase				5 % (p-p)
Differential phase	Modulated 5 step staircase			5	$^{\circ}$ (p-p)

## 6.2. Sound output:

Conditions: Ant.input level: 66 dB $\mu$ V Video signal: color bar PC / SC : 10dB	Testsignal  AF1: 1kHz, 27 kHz deviation, 50 $\mu$ s preemphasis	min.	typ.	max.	unit
Output level AF1:	AC DC		1.2 2.0		V (p-p) V
Load impedance:		1.5			k $\Omega$
Measurements with 50 $\mu$ s deemphasis:					
AF1 - level :		250	300	350	V rms
THD :				0.4	%
S/N (CCIR weighted) :		44			dB
SINAD (22Hz ... 22kHz) :			50		dB
Frequency response: (6 kHz deviation) 40 Hz ... 15 kHz		-1		1	dB

## 6.3. 2nd IF output

AC level of 6.0 MHz:		100		mV (p-p)
6.55 MHz: (PC / NICAM-Carrier : 20dB)		50		mV (p-p)
Load impedance		0.5		k $\Omega$

Note: Short circuit at pin 18 or pin 21 can damage internal circuits.

## 7. I<sup>2</sup>C bus

### 7.1 Write data format

	MSB							LSB	
Address byte	1	1	0	0	0	MA1	MA0	R/W	A
Divider byte 1	0	n14	n13	n12	n11	n10	n9	n8	A
Divider byte 2	n7	n6	n5	n4	n3	n2	n1	n0	A
Control byte 1	1	CP	T2	T1	T0	RSA	RSB	OS	A
Control byte 2	P7	P6	P5	P4	P3	P2	P1	P0	A

A : Acknowledge

### 7.1.1 Address selection

R/W : Read / Write mode      0 : Write mode

MA1	MA0	Address	Voltage at Pin 11
0	0	C0	$(0 \text{ to } 0.1) * V_{S1}$
0	1	C2	always valid
1	0	C4	$(0.4 \text{ to } 0.6) * V_{S1}$
1	1	C6	$(0.9 \text{ to } 1) * V_{S1}$

## 7.1.2 Oscillator frequency and divider byte calculation:

n14, ... n0          Divider bits (**Scaling Factor**)

$f_{osc} = f_w + 38.9 \text{ MHz}$                       ( $f_{osc}$  : Local oscillator frequency;  $f_w$  : wanted frequency )

**SF** =  $f_{osc} / (f_{ref} * 8)$                       ( $f_{ref}$  : Reference divider )

RSA	RSB	Reference divider	Min. tuning step [kHz]	$f_{ref}$ [kHz]
1	1	512	62.5	7.8125
X	0	640	50.0	6.25
0	1	1024	31.25	3.90625

$$\mathbf{SF} = 16348 * n14 + 8192 * n13 + 4096 * n12 + 2048 * n11 + 1024 * n10 + 512 * n9 + 256 * n8 + 128 * n7 + 64 * n6 + 32 * n5 + 16 * n4 + 8 * n3 + 4 * n2 + 2 * n1 + n0$$

## 7.1.3. Control byte settings

**Control byte 1 :**

CP	: Charge pump	<b>1</b>	: fastest tuning
T2	: Test mode bit	<b>0</b>	: normal mode
T1	: Test mode bit	<b>0</b>	: normal mode
T0	: Test mode bit	<b>1</b>	: normal mode
RSA	: Reference divider		: according 7.1.2
RSB	: Reference divider		: according 7.1.2
OS	: PLL disabling	<b>0</b>	: normal mode

**Control byte 2 (Bandselection) :**

Band	P7	P6	P5	P4	P3	P2	P1	P0
------	----	----	----	----	----	----	----	----

# TEMIC

TELEFUNKEN Hochfrequenztechnik GmbH

UHF	X	0	X	X	0	0	0	1
VHF high	X	0	X	X	0	1	0	0
VHF low	X	0	X	X	0	0	1	0

## 7.2. Read data format

	MSB					LSB			
Address byte	1	1	0	0	0	MA1	MA0	R/W	A
Status byte	POR	FL	I2	I1	I0	A2	A1	A0	A

R/W : Read / Write mode                      1 : Read mode  
POR : Power on reset flag                      1 : at power on  
FL : In lock flag                                 1 : PLL is locked  
I2,I1, I0 : Digital levels for I/O ports P7, P5 and P4  
A2, A1, A0 : Digital output of 5-level ADC for AFC function  
Value for correct tuning:                      A2 = 0, A1= 1, A0 = 0

We reserve the right to make changes to improve technical design without further notice

TEMIC TELEFUNKEN Hochfrequenztechnik GmbH, Regensburgerstr.145, D - 85055 Ingolstadt GERMANY

Phone: +49 (0)841 90151 - 20

Fax: +49 (0)841 90151 - 92

NAME	Zahm					
DATE	06.12.95					
REV.:	01	02				
FÄM.- NO.	559	54/96				
DATE	7.12.95	19.04.96				
NAME	Zahm	Zahm				
SIGNATURE						