

MSO

MUSIC WORKSTATION



EDS Enhanced Definition
Synthesis

TouchView
Graphical User Interface

REMS GENERAL
MIDI

Owner's Manual

KORG

Precautions

Location

Using the unit in the following locations can result in a malfunction.

- In direct sunlight
- Locations of extreme temperature or humidity
- Excessively dusty or dirty locations
- Locations of excessive vibration
- Close to magnetic fields

Power supply

Please connect the designated AC adapter to an AC outlet of the correct voltage. Do not connect it to an AC outlet of voltage other than that for which your unit is intended.

Interference with other electrical devices

Radios and televisions placed nearby may experience reception interference. Operate this unit at a suitable distance from radios and televisions.

Handling

To avoid breakage, do not apply excessive force to the switches or controls.

Care

If the exterior becomes dirty, wipe it with a clean, dry cloth. Do not use liquid cleaners such as benzene or thinner, or cleaning compounds or flammable polishes.

Keep this manual

After reading this manual, please keep it for later reference.

Keeping foreign matter out of your equipment

Never set any container with liquid in it near this equipment. If liquid gets into the equipment, it could cause a breakdown, fire, or electrical shock.

Be careful not to let metal objects get into the equipment. If something does slip into the equipment, unplug the AC adapter from the wall outlet. Then contact your nearest Korg dealer or the store where the equipment was purchased.

THE FCC REGULATION WARNING (for USA)

This equipment has been tested and found to comply with the limits for a Class B digital device, pursuant to Part 15 of the FCC Rules. These limits are designed to provide reasonable protection against harmful interference in a residential installation. This equipment generates, uses, and can radiate radio frequency energy and, if not installed and used in accordance with the instructions, may cause harmful interference to radio communications. However, there is no guarantee that interference will not occur in a particular installation. If this equipment does cause harmful interference to radio or television reception, which can be determined by turning the equipment off and on, the user is encouraged to try to correct the interference by one or more of the following measures:

- Reorient or relocate the receiving antenna.
- Increase the separation between the equipment and receiver.
- Connect the equipment into an outlet on a circuit different from that to which the receiver is connected.
- Consult the dealer or an experienced radio/TV technician for help.

Unauthorized changes or modification to this system can void the user's authority to operate this equipment.

Notice regarding disposal (for EU)



If this "crossed-out wheeled bin" symbol is shown on the product or in the operating manual, you must dispose of the product in an appropriate way. Do not dispose of this product along with your household trash. By disposing of this product correctly, you can avoid environmental harm or health risk. The correct method

of disposal will depend on your locality, so please contact the appropriate local authorities for details.

Handling of this product

This product contains precision components, and may malfunction if you fail to observe the following precautions.

- Do not subject this product to vibration or impact.
Doing so may damage internal components and cause malfunctions.
- Do not use or store this product in locations of extremely low or high temperatures, such as outdoors in winter or in direct sunlight in summer. Avoid moving this product between locations of dramatically different temperatures.
If a temperature difference occurs, water droplets may form inside the product. Continuing to use the product in this state may cause malfunctions, so you should wait several hours before using the product.
- Do not use or store this product in locations of extremely high humidity.
- Do not use or store this product in excessively dusty or smoky locations.

Data handling

Incorrect operation or malfunction may cause the contents of memory to be lost, so we recommend that you save important data on media. Please be aware that Korg will accept no responsibility for any damages which may result from loss of data.

-
- * This product uses the T-Kernel source code in compliance with the T-License of the T-Engine forum (www.t-engine.org).
 - * Apple and Mac are trademarks of Apple Inc., registered in the US. and other countries.
 - * Windows XP and Windows Vista are registered trademarks of Microsoft Corporation in the U.S. and other counties.
 - * All other product and company names are trademarks or registered trademarks of their respective holders.

Thank you for purchasing the Korg M50 Music Workstation. To help you get the most out of your new instrument, please read this manual carefully.

About this manual

The owner's manuals and how to use them

The manuals and how to use them

The M50 comes with the following operation manuals.

- M50 Owner's Manual
- M50 Parameter Guide (PDF)
- M50 Installation Guide (PDF)
- M50 Editor/Plug-In Editor Manual (PDF)

The above PDF files are located in the "MANUALS" folder of the included CD-ROM. Driver operating manuals such as for the KORG USB-MIDI driver are located in the same folder as the drivers.

M50 Owner's Manual

Please read this first. It explains the names and functions of each part of the M50, how to make connections, basic operation, an overview of each mode, how to edit sounds, and how to record on the sequencer. This guide also explains the arpeggiator, effects, drum track, and drum kits.

This also explains items you should check before suspecting a malfunction, error messages, and specifications.

M50 Parameter Guide

This explains details of the M50's parameters, organized by mode and page. Refer to this guide when you want to learn more about an unfamiliar parameter.

M50 Installation Guide

This explains installation of KORG USB-MIDI Driver, and setup of the M50.

M50 Editor/Plug-In Editor Manual

This explains setup and use of M50 Editor and M50 Plug-In Editor.

Conventions in this manual

The M50 is available as two models: the 88-key M50-88 and the 61-key M50-61. References in these manuals to "the M50" refer to all of these models collectively.

Abbreviations for the manuals: OM, PG

In the documentation, references to the manuals are abbreviated as follows.

OM: Owner's Manual

PG: Parameter Guide

Procedure steps 1. 2. 3. ...

These indicate the steps of a procedure.

Symbols , , Note, Tips

These symbols respectively indicate a caution, a MIDI-related explanation, a supplementary note, or a tip.

Example screen displays

The parameter values shown in the example screens of this manual are only for explanatory purposes, and may not necessarily match the values that appear in the Display of your instrument.

MIDI-related explanations

CC# is an abbreviation for Control Change Number.

In explanations of MIDI messages, numbers in square brackets [] always indicate hexadecimal numbers.

What is REMs ?

REMS (Resonant structure and Electronic circuit Modeling System) is Korg's proprietary technology for digitally recreating the numerous factors that produce and influence a sound, ranging from the sound-production mechanisms of acoustic instruments and electric/electronic musical instruments, to the resonances of an instrument body or speaker cabinet, the sound field in which the instrument is played, the propagation route of the sound, the electrical and acoustic response of mics and speakers, and the changes produced by vacuum tubes and transistors.

Table of Contents

Handling of this product	ii
Data handling	ii
About this manual	iii

Quick Start 1

Setup.....	1
Playing Programs and Combinations	2
Listening to the demo songs	5

Introduction to the M50 7

Main Features 7

Front and rear panels 9

Front panel	9
Rear panel	11
Objects in the display	12

Basic Information..... 14

About the M50's modes.....	14
Basic operations	16
Using Controllers	19

Setup 23

Turning the power on/off 23

Connecting the AC adapter.....	23
Turning the power on.....	23
Turning the power off.....	23

Connections..... 24

Connecting audio equipment	25
Connecting a damper pedal, foot switch, or foot pedal	25
Connecting the M50 to a computer.....	26
Connecting MIDI devices.....	26

Playing and editing Programs... 27

Playing Programs 27

Selecting Programs	27
Using Controllers	29
Performing with the arpeggiator or drum track ...	29

Easy Program editing..... 30

Simple editing using the sliders and knobs	30
Using Tone Adjust	32
Restoring settings you've edited	32
Saving your edits	33

Detailed Editing with Programs 34

Basic oscillator settings	34
Using LFOs and Envelopes (EGs).....	36
Using Alternate Modulation (AMS) and the AMS Mixers.....	37
Controlling Pitch.....	37
Using Filters	38
Using the Amp section.....	40
Arpeggiator settings.....	42
Drum Track settings	42
Effects.....	42
Automatically importing a Program into Sequence mode.....	42

Playing and editing Combinations..... 43

Playing combinations 43

Selecting Combinations.....	43
Performing with the arpeggiator or drum track ...	44
Using controllers to modify the sound.....	44

Easy Combination editing..... 45

Changing the program assigned to a timbre.....	45
Adjusting the mix.....	45
Simple editing using the knobs.....	45
Saving a Combination you've edited	46

Detailed Editing with Combinations 47

A suggested approach for editing	47
Restoring edited settings.....	47
Layers, Splits, and Velocity Switches	48
MIDI settings	49
Altering Programs to fit within a Combination ...	50
Arpeggiator settings.....	50
Drum Track settings	50
Effects.....	50
Automatically importing a Combination into Sequencer mode.....	50

Creating songs (Sequencer mode) 51

Overview	51
About the M50's Sequencer	51
Sequencer mode structure	51
Functions of each switch	52

Playing Songs 53

Playback	53
--------------------	----

MIDI recording 55

Preparations for recording	55
Recording MIDI in real time	57
Step recording	58
Recording variation	60
Recording patterns in real time	61

Song editing 62

Creating an RPPR pattern 63

Creating RPPR data	63
RPPR playback	64
Realtime-recording an RPPR performance	64

Creating and playing a Cue List 65

Creating a cue list	65
Converting a cue list to a song	66

Saving your song 66

Using Effects 67

An overview of the M50's effects 67

Effect I/O	67
Effects in each mode	68

Routing effect settings 69

Program Effects settings	69
Using effects in Combinations and Songs	71
Dynamic modulation (Dmod)	72
Common FX LFO	72

Arpeggiator function 73

Using the arpeggiator while you play 73

Using the arpeggiator in Program mode	73
Using the arpeggiator in Combination mode	76
Other settings for the arpeggiator	77
Linking the arpeggiator to program, combinations	77
Arpeggiator synchronization	77
Creating a user arpeggio pattern	77

Drum Track function 79

Performing with the Drum Track function . . 79

Using the Drum Track function in Program mode	79
Using the Drum Track function in Combination mode	80
Other settings for the drum track	81
Drum track synchronization	81
Creating drum track patterns	81

Settings for the entire M50 83

How Global mode is structured 83

Global settings 83

Basic setup	83
MIDI Basic/Routing	84
Pedal and other controller settings	84
Setting Category Names	84

External control 85

Using Drum Kits 85

What's a Drum Kit?	85
------------------------------	----

Loading & saving data 87

Saving data 87

Types of data that can be saved	87
Writing to internal memory	88
Editing names	91
Saving to media (Media-Save)	91
Using the M50 as a data filer	92

Loading data 93

Data that can be loaded	93
Loading data from media (Media-Load)	93

Media utility 96

Formatting media	96
Specifying the save date and time	96

Appendices	97
Restoring the factory settings	97
Loading the preloaded data	97
Troubleshooting	98
Power supply	98
Display	98
Audio output	98
Programs and Combinations	99
Songs.....	99
Arpeggiator.....	100
Drum Track function	100
Drum Kits.....	100
Effects	100
MIDI	101
Damper pedal does not respond correctly	101
Media	101
Connections with a computer	101
Included CD-ROM.....	102
Initialization	102
Error messages	103
Error and confirmation messages.....	103
Specifications and options	107
Specifications.....	107
Options.....	108
Operating requirements	109
MIDI Implementation Chart	110
Index	111

Quick Start

This Quick Start is provided for those who just want to get started trying out the sounds right away.

It explains how to set up the M50, how to select programs and control the sound, and how to listen to the demo songs.

After you've finished reading this Quick Start section, please also take a look at the full explanations that follow.

Setup

Here's how to connect the power cable and audio cables, and how to turn on the power.

⚠ You must use only the included AC adapter. Using any other AC adapter may cause malfunctions.

Note: Make sure that the M50's power switch is set to STANDBY (the outward position).

1. Connect the plug of the included AC adapter to the power connector on the M50's rear panel.
2. Connect the power cable to the AC adapter.
3. Plug the power cable into an AC outlet.
4. To prevent the plug from being pulled out accidentally, wrap the AC adapter cable through the cable hook located on the rear of the M50. Be careful not to bend the base of the plug unnecessarily.

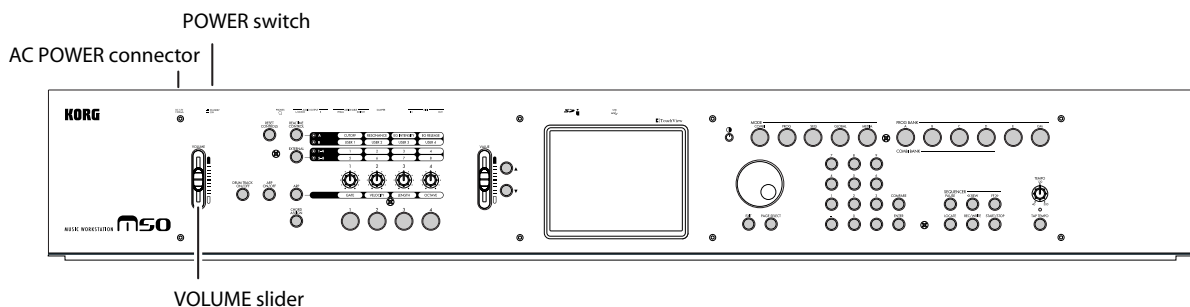
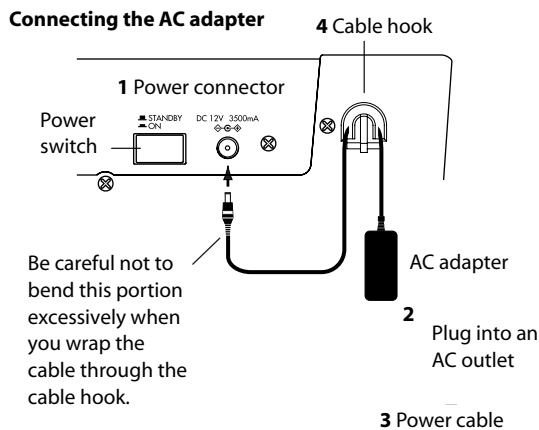

Example of removing the cable from the cable hook

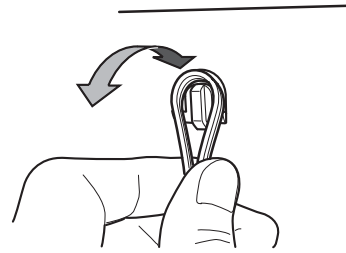

5. Connect the M50 to your mixer or monitor system.

Connect the M50's AUDIO OUTPUT L/MONO and R jacks to your mixer or amplified monitor speakers.

If you're monitoring through headphones, connect them to the headphone jack located on the rear of the M50. The headphones will output the same sound as the AUDIO OUTPUT L/MONO and R jacks.

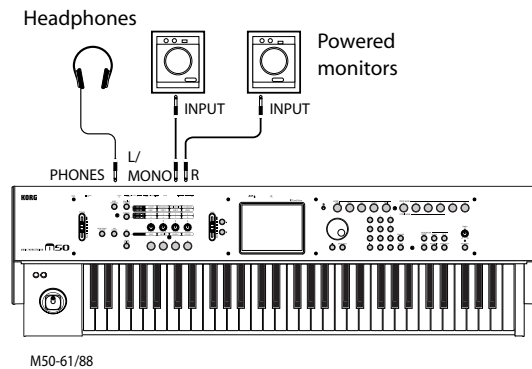

6. Lower the M50's VOLUME slider.

Turn on your audio monitor system and set the volume to a normal level.

7. Turn on the M50 by pressing the power switch located on the rear panel.

8. Raise the volume of the connected equipment to an appropriate level. Then gradually raise the M50's VOLUME slider to adjust the volume as desired.

Playing Programs and Combinations

With the factory settings, Program mode will be selected when you turn on the power. When you play the keyboard, you'll hear the sound of program number 000 in PROG Bank A.

Note: If you don't hear any sound when you play the keyboard or press a chord trigger switches: Check the connections once again. Also make sure that the M50's VOLUME slider and the volume of your powered speakers or stereo amp are turned up appropriately.

Selecting Programs

If the display indicates a different mode, press the MODE PROG switch (LED lit) to enter Program mode.

1. The upper left of the display shows the name of the current page, Prog P0: Play. This is the page in which you will normally play programs.

Play the keyboard or press a chord trigger switches to hear the sound.

Note: If you are viewing a different page in the display, press the EXIT switch one or two times to take you back to the program name selection.

2. The large characters in the upper part of the display will be highlighted.

These are the program number and program name ("Program Select").

In this state, you can press the Δ switch or ∇ switch to select the program with the next higher or lower number.

You can also turn the VALUE dial to rapidly scroll through the programs.

3. Use the BANK SELECT A-GM switches to select other banks of programs.

With the factory settings, contain preloaded programs. Select and play these programs to hear their sounds.

For details on the programs in each bank, please see "Overview: Program Banks" on page 28.

4. Press the popup button located at the left of "Program Select" in the display.

A list of the programs in each bank will appear.

Use the tabs located at the left to select the desired bank.

Then press a program within the menu to select it. By using the scroll bar located below the menu you can view the other programs in that bank that are not currently displayed.

You can press the Δ switch or ∇ switch to select the program with the next higher or lower number.

When you've chosen the program you want to play, press the OK button or the ENTER switch.



5. There are several other ways to select programs, but here we'll explain how to select programs using categories such as "keyboard," "organ," "bass," or "drums."

Press the Category Select popup button in the display. This is the rectangular button located above the program name.



The Category/Program Select menu will appear, showing a list of the programs for each category. Press the tabs located at the left and right to select the desired category.

Then press a program in the menu to select it.

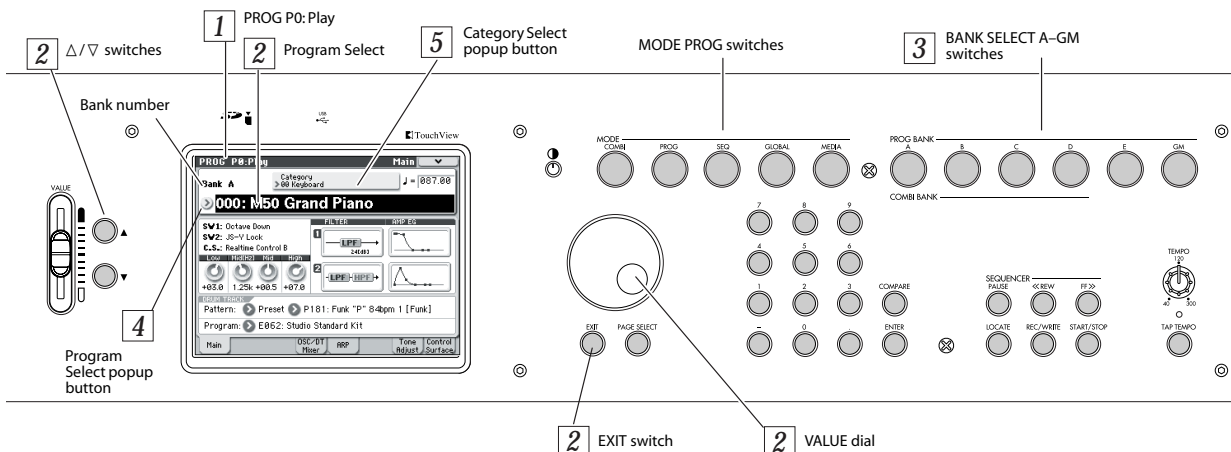

You can press the Δ switch or ∇ switch to select the program with the next higher or lower number.

When you've chosen the program you want to play, press the OK button or the ENTER switch.

Categories also have sub-categories, and you can press the Jump to Sub button of the Category/Program Select menu to choose programs from a sub-category list.

Selecting combinations

A combination consists of up to sixteen programs that are split and/or layered. A combination also allows you to use two arpeggiators (a program allows only one), letting you hear more complex sounds than a program.

1. Press the MODE COMBI switch (the LED will light) to enter Combination mode.
2. The upper left of the display shows the name of the current page, Combi P0: Play. This is the page in which you will normally play combinations.

Play the keyboard or press a chord trigger switches to hear the sound.

Note: If you are viewing a different page in the display, press the EXIT switch one or two times to take you back to the combination name selection.

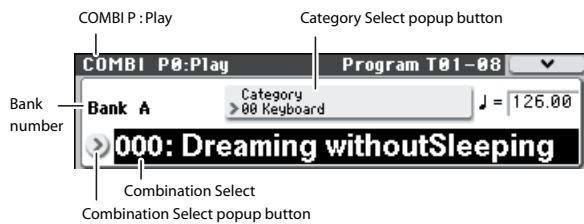

3. The large characters in the upper part of the display will be highlighted.

These are the combination number and combination name ("Combination Select").

In this state, you can press the Δ switch or ∇ switch to select the program with the next higher or lower number.

You can turn the VALUE dial to rapidly scroll through the programs.

4. Use the BANK SELECT A-D switches to select combinations of other banks.

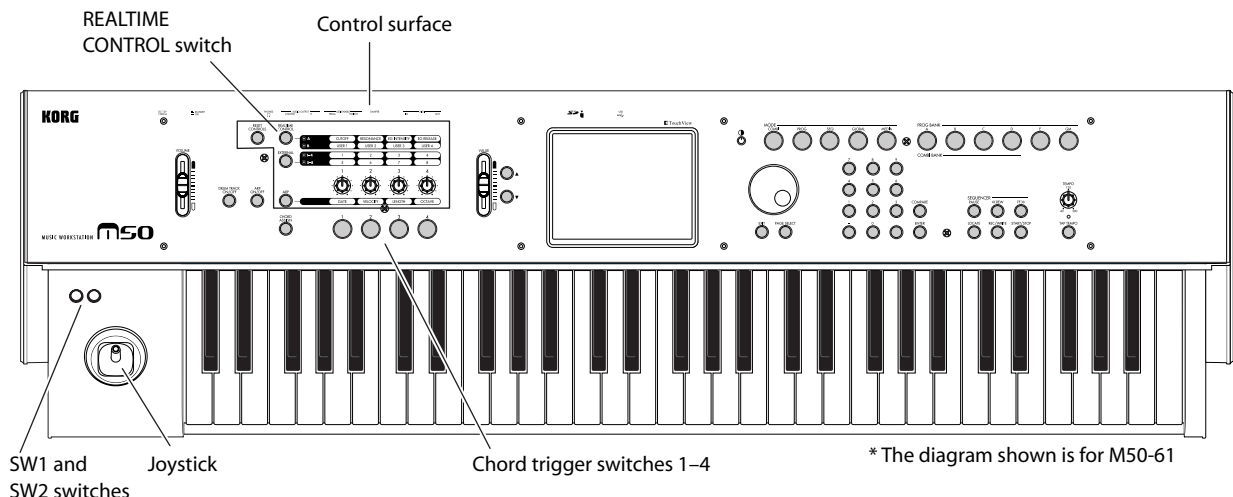

* The diagram shown is for M50-61

With the factory settings, contain preloaded programs. Select and play these combinations to hear their sounds.

5. As in Program mode, you can select combinations from the menu by bank or by category.

As described in steps 4 and 5 of "Selecting Programs" on page 2, go ahead and select and play combinations in the same way as you did for programs.

Using controllers to modify the sound

The M50 has numerous controllers.

The result will differ for each Program and Combination, so try them out to hear what happens. For details on these controllers, please see "Using Controllers" on page 29.

1. In the left side of the M50's panel, there are four switches and four knobs.

This is called the "control surface," and lets you perform various types of control such as editing sounds, or sending MIDI messages to external devices.

For example, go ahead and press the REALTIME CONTROL switch (the LED will light).

Operating the each knobs will control the frequency cutoff, resonance, and intensity, or any other parameters you specify.

The display can show the function and values of the control surface. To view this, press the Control Surface tab located in the lower right of the display.

When you operate the controllers, the objects in the display will move accordingly.

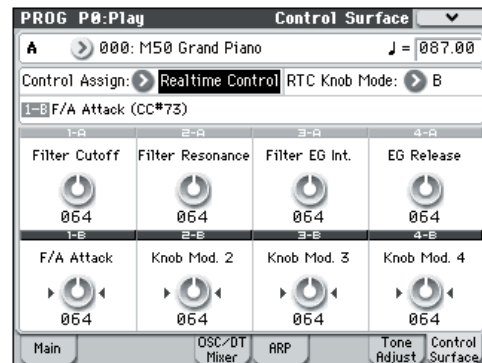

Note: Even if you've modified the sound, you can restore the program to its saved condition.

You can recall the saved settings by holding down the RESET CONTROLS switch and turning each knob of the control surface (see page 21).

2. Below the control surface there are four chord trigger switches.

You can use these to trigger chords (of up to eight notes).

This is a useful way to play chords, or to use the arpeggiator. You can easily assign notes or chords to the switches (see page 21).

Performing with the arpeggiator

The arpeggiator is a function that automatically generates arpeggios (broken chords). A typical arpeggiator generates an arpeggio from a chord that you play on the keyboard.

You can use the four knobs of the control surface to modify the arpeggio that is generated.

1. Press the ARP ON/OFF switch (the key will light).

When you play the keyboard, the arpeggiator will generate an arpeggio.

Note: With the factory settings, the arpeggiator will automatically turn on when you select certain programs.

2. Press the control surface ARP switch, and operate knob 1 (Gate), knob 2 (Velocity), knob 3 (Length), and knob 4 (Octave).

Knob 1 (GATE) changes the duration of the arpeggiated notes.

Knob 2 (VELOCITY) changes the loudness of the arpeggiated notes.

Knob 3 (LENGTH) changes the length of the arpeggio pattern.

Knob 4 (OCTAVE) changes the range of pitches in which the arpeggio is generated.

When a knob is in the center position (12 o'clock), the settings will have the values that are stored in the program.

Note: Depending on the program that's selected, operating knob 4 may not produce any effect.

3. Adjust the tempo of the arpeggio.

You can adjust the tempo either by turning the TEMPO knob or by pressing the TAP TEMPO switch several times at the desired interval.

Performing with the Drum Track

This feature provides an easy way to play a wide variety of Drum Track patterns using the M50's high-quality drum programs. Playing a Program or Combination along with Drum Track patterns is a convenient way to come up with phrases or work out the structure of your song.

1. Select Combination mode or Program mode.

For this example, press the MODE PROG switch to select Program mode, and access the Prog P0: Play-Main page. If another page is displayed, you'll need to press the EXIT switch one or two times.



2. Press the DRUM TRACK ON/OFF switch.

The ON/OFF switch will be lit or blinking. This will depend on the setting of the program.

If it's lit, the Drum Track pattern has begun playing. Press the ON/OFF switch once again to stop.

If it's blinking, the Drum Track pattern will start when you play the keyboard, touch a chord switch, or when a MIDI note-on is received.

3. To change the Drum Track pattern, use "Pattern Bank" and "Pattern No." to select the desired pattern.

Note: You can create your own original Drum Track patterns (see PG page 208).

4. Use "Drum Track Program" to select the program that will be played by the Drum Track pattern.

Note: Only programs in category number 15 (Drums) can be selected.

Listening to the demo songs

Loading the demo song data

1. Press the MODE GLOBAL switch (the LED will light) to enter Global mode.
2. Access the Global P0: Basic Setup page.
If another page is displayed, press the EXIT switch.
3. Press the menu button in the upper right of the display, and choose “Load Preload/Demo Data.”

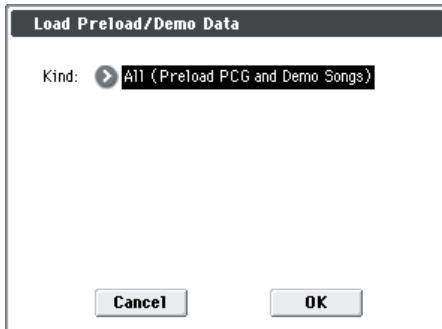

4. In the “Kind” field, choose “All (Preload PCG and Demo Songs).”

When you execute loading, the preloaded data and the demo song data will be loaded.

- ⚠ If you've edited a preloaded program or combination, or created one from scratch, executing this Load operation will overwrite your data; i.e., your changes will be lost. Before loading the Preload PCG data, save your programs on an SD card (commercially available). (See PG page 260)

5. Press the OK button or ENTER switch.

A dialog box will ask you for confirmation.

Press the OK button or ENTER switch once again to load the data.

- ⚠ Never turn off the power while data is being loaded.

If the Memory Protected dialog appears, press the System Pref. tab and clear the check mark from the Memory Protect **Song** setting. Then load the data again.

Playing the demo songs

1. Press the MODE SEQ switch (the LED will light) to enter Sequencer mode.
2. Access the P0: Play/REC- Program T01-08 page.
If this page is not displayed, you'll need to press the EXIT switch a few times.

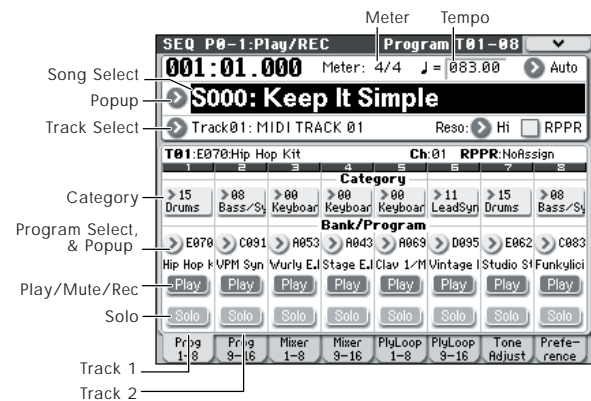

3. Let's start by listening to song S000.

Verify that song S000 is selected. If another song is selected, press the song name display area (**Song Select**) to highlight it. Then press the numeric key 0, and then the ENTER switch.

4. Press the SEQUENCER START/STOP switch.

The LED will blink, and the song will begin playing back.

5. If you want to stop playback mid-way through the song, press the START/STOP switch once again.

6. Let's listen to the next song.

Press the song name display area (**Song Select**). Press the numeric key 1, and then press the ENTER switch. (Song “S001” will be selected.)

Alternatively, you can press the round button (Song Select popup) located to the left of the song name, and a list of song names will appear. Press one of the song names to select a song.

7. Press the SEQUENCER START/STOP switch to begin playback. To stop playback, press the START/STOP switch once again.

- ⚠ The demo song will not be retained when the power is turned off, but you can load it again at any time.

Playing back a cue list

Songs can be assigned to a cue list, and will playback in the specified order. You can also specify the number of times that each song will be repeated. Here's how to play back the demo songs assigned to a cue list.

1. Access the P11: Cue List page.

Press the PAGE SELECT switch to access the Seq Page Select page. Press "P11 Cue List" in the display.

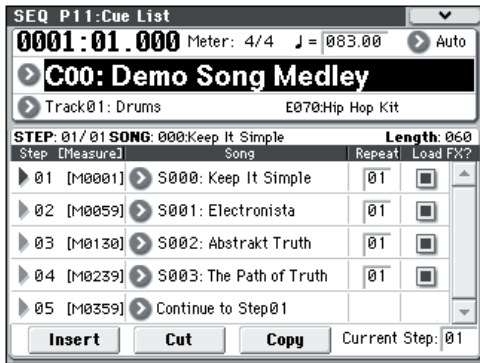

2. Press the SEQUENCER START/STOP switch.

You will hear the songs in the list in the assigned order. If you want to stop playback before you reach the end of the list, press the START/STOP switch once again.

Performing with RPPR

In Sequencer mode, the RPPR (Realtime Pattern Play/Recording) function allows you to assign a preset pattern or user pattern (and a track to play it) to each key.

This way, you can play a pattern simply by pressing the key to which it is assigned. You can also record the resulting playback.

The demo songs you loaded contain data that uses the RPPR function. Here's how you can use it.

1. Access the P0: Play/REC- Program T01-08 page, and select S001: Electronista.

For details, refer to steps 6 and 7 on the preceding page.



2. Make sure that the "RPPR" check box is checked.

If this is checked, RPPR will operate.

If this is unchecked, RPPR will not operate.

3. Press a key C#2 or above.

The pattern assigned to that key will begin playing. A pattern such as a drum pattern or bass phrase etc. can be assigned to each of the seventy-two keys C#2-C8 (indicated in the illustration as Pattern Assignable). Keys that are not assigned will play normally.

In some cases, the pattern will continue playing even after you release the key. If so, you can stop playback by pressing that key once again, or by playing any key C2 or below (indicated in the illustration as Shutdown Keys).

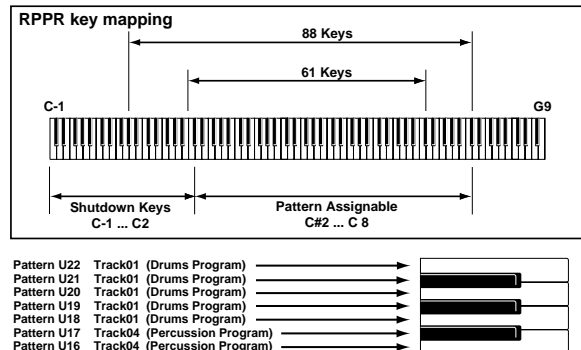

This completes our quick start.

Of the M50's wide range of functionality, this operation guide explains how to use some of the most typical operations. We highly recommend that you take the time to read it completely.

Introduction to the M50

Main Features

EDS (Enhanced Definition Synthesis)

The M50 is based on the same EDS (Enhanced Definition Synthesis) found in the M3, delivering rich and vivid sound.

Each voice has two oscillators (allowing four-stage velocity switching/crossfading/layering) and can use up to eight (stereo) multisamples, up to four filters (two filters per oscillator with four modes and four routings), two amps, five LFOs, and five EGs, all available simultaneously.

The oscillator section provides a total of 1,077 multisamples (including seven stereo multisamples) sampled at 48 kHz, as well as 1,609 drum samples (including 116 stereo drum samples), giving you a total of 256 Mbytes of sample data (when considered as 16-bit linear data). These PCM sources are available for use in the oscillator section via four-way velocity switching/crossfading/layering to create a broad range of expressive, high-quality sounds.

The filter section - so vital to creative sound design - lets you simultaneously use two filters for each oscillator. Filter types include low-pass, high-pass, band-pass, and band-reject (notch). You can use the two filters in any of four routings: single, serial, parallel, or 24 dB mode.

The amp section provides a driver circuit that adds edge and character to the sound.

The key tracking generator allows the filtering to vary according to the keyboard range; you can apply subtle filtering for convincing simulation sounds, or aggressive filtering that produces drastic changes in filtering as you play up or down the keyboard.

The M50 takes advantage of its lavish amount of available processing power to produce ultra-fast and ultra-smooth EGs (envelope generators) and LFOs.

EGs allow you to specify how the sound develops over time, from its onset to its end. Each EG stage (attack, decay, slope, and release), gives you detailed control over how the tone and volume change over time, and make it possible to program anything from simulated acoustic sounds to vintage synthesizer sounds with the utmost detail.

Korg's AMS (Alternate Modulation Sources) provides a rich array of modulation possibilities, with 50 different modulation sources that you can use to control the sound in complex ways. The M50 takes this classic Korg feature even further, via the AMS Mixers. These let you create even more detailed modulation designs by mixing two modulation sources together, multiplying one modulation source by another, or modifying the shape of the modulation source in various ways.

Programs, Drum Tracks, and each of the sixteen timbres/tracks has its own three-band EQ, letting you make detailed adjustments to the tonal character.

To let you shape the final character of the overall sound, the effect section provides up to five insert effects, two master effects, and one total effect. In

addition to delay and reverb, a total of 170 high-quality effects are available, including modulation-type effects such as chorus, phaser, and flanger; dynamic-type effects such as compressor and limiter; and amp-modeling effects generated using Korg's proprietary "REMS" modeling technology. There are also two common LFOs that can be shared between different modulation effects. For example, you can create sophisticated effects such as using a single common LFO to synchronize the modulation frequency of a phaser and a flanger used on different timbres. Effect dynamic modulation (Dmod) lets you control the sound or the effects in a wide variety of ways, ranging from the subtle to the dramatic.

Drum Track function

The Drum Track function lets you listen to drum patterns while you construct the outline of your song. You can easily select the M50's built-in patterns or create your own, and then start the pattern from a specified region of the keyboard or by playing a velocity higher than a specified threshold.

This function is also useful for anything from realtime performance to generating sketches for song production

Enhanced Sequencing

The heart of any music production system is the sequencer. The M50's sequencer lets you record 16 MIDI tracks, up to 128 songs, and 210,000 notes. With a high resolution of 1/480, every timing nuance of your performance will be captured accurately. You can use the Cue List function to create your song section by section and then play it back as a medley in the form you want.

Auto Song Setup function

Auto Song Setup takes care of many assignment and routing tasks automatically, so that the sequencer is armed with programs, combinations, effects, drum track and arpeggiator settings making it easy to create the basic tracks at the core of your song.

Dual polyphonic arpeggiator

Five preset arpeggio patterns (UP, DOWN, ALT1, ALT2, RANDOM) and 1,028 user arpeggio patterns are built-in.

In addition to providing conventional arpeggiator functions, the polyphonic arpeggiator of the M50 can respond to the pitches or timing at which you play the keyboard, and produce a diverse range of chords or phrases. This can be used to play a variety of drum phrases (the "Fixed Note Mode" is ideal for drums), bass phrases, or guitar and keyboard backing riffs. The arpeggiator is also effective for use with subtly moving pads, synth sounds, or sound effects.

In Combination mode, and Sequencer mode, the M50 provides dual arpeggiators so you can simultaneously play two arpeggio patterns. You can apply separate arpeggio patterns to the drum and bass programs, or use keyboard splits or velocity to switch between arpeggio patterns for an even more dynamic performance.

Display

The M50 features Korg's exclusive TouchView graphical user interface. By simply touching the display, you can efficiently and intuitively access the M50's enormous wealth of parameters. The crisp 320 x 240 pixel display provides excellent visibility.

Chord trigger switch

The four chord trigger switches can trigger single notes or chords (of up to eight notes), and are a useful way to play chords, or to control the arpeggiator performance. You can easily assign notes or chords to the chord trigger switches as desired.

Control surface

The four knobs of the control surface give you greater expressive power when using realtime control functions to create and control your sounds. Along with the chord trigger switches, you can use these knobs as an external mode setup for controlling an external MIDI device.

Editor, Plug-In Editor

The bundled "M50 Editor" and "M50 Plug-In Editor" software are applications that let you edit M50 sounds such as programs, combinations, and drum kits from your computer.

"M50 Editor" is a stand-alone editor. "M50 Plug-In Editor" supports VST, Audio Units, and RTAS formats, allowing you to use the M50 as if it were a plug-in instrument in your DAW (Digital Audio Workstation) software or other host application.

Note: The multisample and preset pattern list have been updated in version 1.0.1 of M50 Editor/Plug-In Editor. In order to maintain compatibility of the display in the edit window, please download and use the most recent version of the editor.

You can download the most recent versions of the editor, plug-in editor, and Korg USB-MIDI driver from the following website.

Korg website: "<http://www.korg.com/>"

Front and rear panels

Front panel

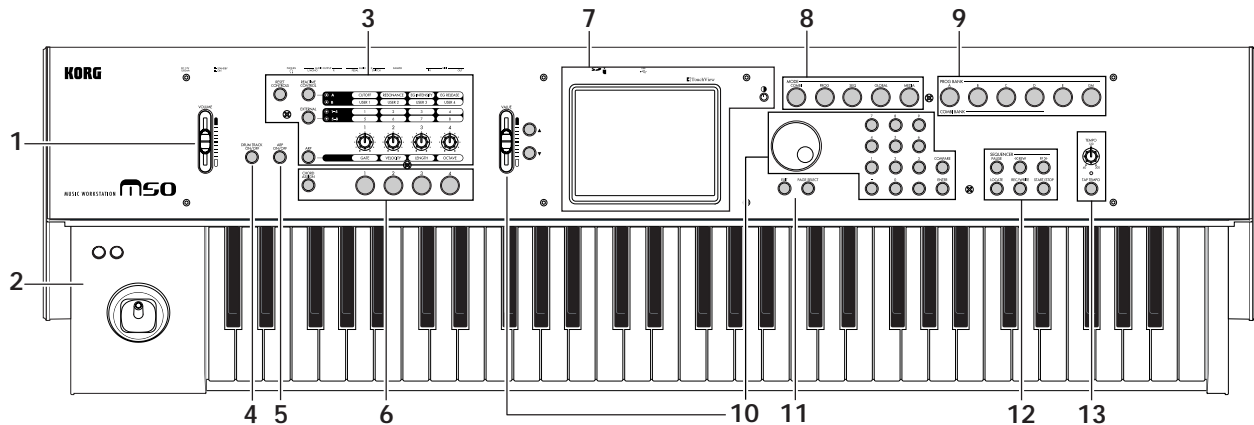

*The diagram shown is for M50-61

1. Volume

VOLUME slider

This slider adjusts the volume of the AUDIO OUTPUT L/MONO, R outputs, as well as the volume of the headphone jack. (See page 23)

2. SW1, 2 and Joystick

SW1 and SW2

These switches are used to control the programs or effect parameters, or to turn the joystick lock function on/off. (See page 19)

Joystick

You can control synthesis parameters or effect parameters by moving the joystick up/down/left/right. (See page 19)

3. Control Surface

The control surface consists of the four knobs located to the left of the display, the three REALTIME CONTROL, EXTERNAL, and ARP switches, and the RESET CONTROLS switch that resets the function of these controls.

You can use these as realtime controllers to modify the sound, as external controllers to transmit MIDI messages to an external MIDI device, or to control the arpeggiator.

As explained below, you can use the front panel CONTROL ASSIGN switches to switch between the various control surface functions. You can also view and edit the control surface settings in the display (P0-8: Control Surface page in each mode).

CONTROL ASSIGN:

Knobs 1-4

The functions of these four knobs will change based on the REALTIME CONTROL, EXTERNAL, and ARP switches, as described below.

For more details, please see “Control Surface knobs” on page 20.

REALTIME CONTROL switch

When you press this switch, knobs 1-4 will modify the sound and effects. You can press this switch repeatedly to cycle between different control functions. (See page 20, and page 30)

EXTERNAL switch

When you press this switch, knobs 1-4 and chord trigger switches 1-4 will transmit MIDI messages to an external MIDI device. You can press this switch repeatedly to cycle between different control functions. (See page 85, and PG page 224)

ARP switch

When you press this switch, knobs 1-4 will control the arpeggiator settings. (See page 73)

RESET CONTROLS switch

This resets the controllers of the control surface, returning them to the saved values or default values.

For details, please see “Resetting the controller settings” on page 21.

4. DRUM TRACK

DRUM TRACK ON/OFF switch

This switch turns the Drum Track function on or off. When the DRUM TRACK ON/OFF switch is off (the LED will go dark), pressing this switch will make the LED light or blink. (See page 79)

5. Arpeggiator

ARP ON/OFF switch

This switch turns the arpeggiator on/off. The switch will be lit if the arpeggiator is on. (See page 73)

6. Chord trigger switch

SW 1...4

When you press a chord trigger switch, the assigned single note or chord (up to eight notes) will sound. (See page 21)

CHORD ASSIGN switch

Use this switch to assign single notes or chords to the chord trigger switches. (See page 21)

7. Display

Display

The TouchView display features simple touch control and selection of numerous features and parameters. (See page 12)

Contrast knob

This knob adjusts the contrast of the display for the best viewing from any angle or under changing light conditions.

8. Mode

COMBI, PROG, SEQ, GLOBAL, MEDIA switches

M50 has five different operational modes, each one optimized for a specific set of functions.

Press one of these switches to enter the corresponding mode.

For details, please see “Selecting modes” on page 16.

9. PROG/COMBI BANK

A, B, C, D, E, GM switches

These switches select program banks A–GM and combination banks A–D (see page 28, and page 44). You can also use these switches to select the bank of timbre programs in a combination, or the bank of track programs in a song (see page 45, and page 55).

10. VALUE controller

Use this controller to edit the parameter that's selected in the display.

VALUE slider

Inc Δ and Dec ∇ switches

VALUE dial

0–9, -, ., and ENTER switches

ENTER switch

Together, these controls specify and confirm the value of the selected parameter. (See page 17)

COMPARE switch

Compares your current sound edits to the sound before it was edited.

For details, please see “Compare function” on page 18.

11. PAGE SELECT, EXIT

PAGE SELECT switch

When you press this switch, a list of the pages within the selected mode will appear in the display. Press the button of the desired page. (See page 16)

EXIT switch

Press this switch to return to the main page of the current mode. (See page 17)

12. Sequencer

The switches in this section are used for operations in Sequencer mode, such as recording and playback (see page 52). The REC/WRITE switch is also used to save a program or combination (see page 88), or when using the Auto Song Setup function (see page 60).

PAUSE switch

<<REW switch

FF>> switch

LOCATE switch

REC/WRITE switch

START/STOP switch

13. TEMPO controls

TEMPO knob

This knob adjusts the tempo of the arpeggiator, drum track, or internal sequencer.

TEMPO LED

This LED will blink at quarter-note intervals of the current tempo.

TAP TEMPO switch

By pressing (or tapping) this switch on the beat, you can enter the tempo used by the arpeggiator, drum track, or internal sequencer (see page 21).

Rear panel

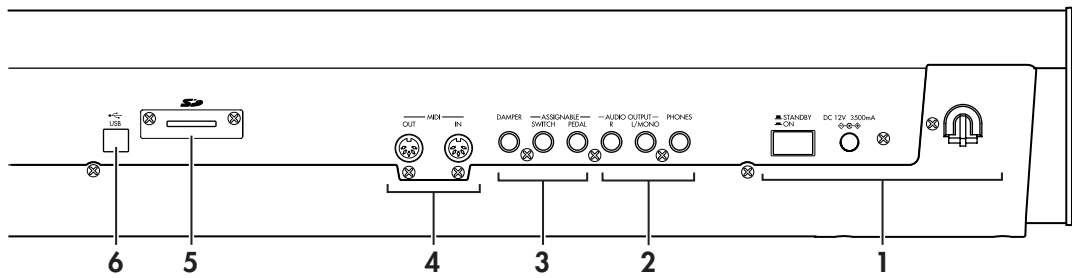

1. Power supply

Be sure to see “Turning the power on/off” on page 23 and follow the correct procedure described there.

Power switch

This switch turns the power on/off. (See page 23)

AC adapter connector

The included AC adapter is connected here. (See page 1 and page 23)

- ⚠ Connections must be made with the power turned off. Please be aware that careless operation may damage your speaker system or cause malfunctions.

Cable hook

Use this to secure the cable of the included AC adapter. After connecting the AC adapter, loop the cable around the hook located on the M50's rear panel so that the cable won't get pulled out inadvertently. Leave enough slack on the plug end so that you can disconnect it if you want to. For details, please see “Setup” on page 1.

- ⚠ Be careful not to bend the base of the plug any more than necessary.

2. AUDIO OUTPUTS

AUDIO OUTPUT L/MONO jack

These are the main stereo audio outputs. Use the VOLUME slider to adjust the volume. (See page 24)

PHONES jack

Connect your headphones here.

This jack will output the same signal as the AUDIO OUTPUT L/MONO and R jacks.

The headphone volume is controlled by the VOLUME slider.

3. PEDALS

You can connect a damper pedal, foot switch, and foot pedal to these jacks. This gives you a broader range of functions and effects to control. (See page 25)

- ASSIGNABLE PEDAL jack
- ASSIGNABLE SWITCH jack
- DAMPER jack

4. MIDI

MIDI lets you connect the M50 to a computer or other MIDI devices, for sending and receiving notes, controller gestures, sound settings, and so on. (See page 26)

- MIDI IN connector
- MIDI OUT connector

5. SD

SD card slot

You can insert an SD card here, and use it to save/load M50 programs, combinations, or song data. (See page 91)

6. USB

USB connector (for connecting to computer)

You can connect your computer to this connector. Using a single USB cable, your M50 can send and receive MIDI information directly to and from a computer, without requiring a MIDI interface. (See page 26)

Note: The USB connector of the M50 is only able to transmit and receive MIDI data.

Objects in the display

The M50 uses Korg's TouchView graphical user interface.

By touching on objects shown in the display, you can select pages, set parameter values, rename programs and combinations, write data, and perform many other operations.

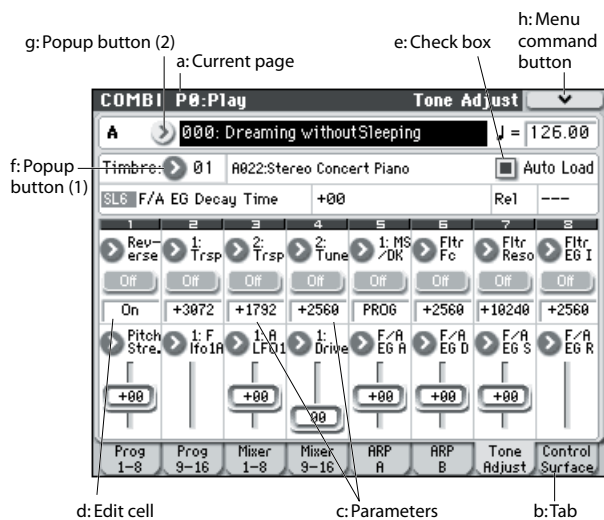

a: Current page

This indicates the current page within the selected mode.

Beginning at the left, this area shows the mode name, page number: name, and tab name.



b: Tab

Most pages are divided into two or more tabs.

c: Parameters

The parameters for various settings are shown in the display.

d: Edit cell

When you touch a parameter in the display, the parameter or parameter value will usually be highlighted (displayed in reverse highlighting). This is called the **edit cell**, and the highlighted item will be available for editing.

For details on how to edit the value, please see "Selecting a parameter and editing the value" on page 17.

e: Check box

Each time you press a check box, it alternates between the checked (red) and unchecked states.

The parameter will be active if it is checked, and inactive if it is unchecked.

f: Popup button (1)

When this button is pressed, a popup menu will appear, showing the parameter values that are available for selection.

To enter the parameter value, press the desired value in the popup menu.

* Popup menu

Pin

This switches the popup menu display between locked and unlocked.

When locked, the pin will be shown closed, and the popup menu will remain displayed even after you press a parameter value. When unlocked, the pin will be shown opened, and the popup menu will close immediately when you press a parameter value.

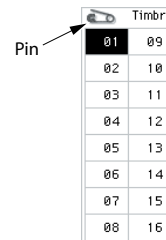

g: Popup button (2)

When you press this button, a tabbed menu will appear.

To close a tabbed menu, press the OK button or Cancel button.

Scroll bar

Use this when you need to see parameter values that extend beyond what can be shown in the display at one time.

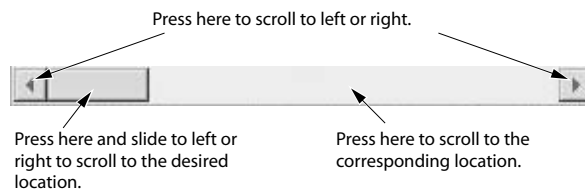

h: Menu command button

* Menu

When this button is pressed, a list of menu commands will appear.

The menu commands that appear will differ depending on the currently selected page.

You can also select up to ten menu commands by holding down the ENTER switch and pressing a numeric key 0-9. The menu will close when you press the display at a location other than the menu, or when you press the EXIT switch.

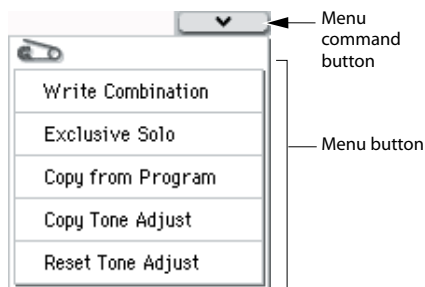

* Dialog box

A dialog box may appear, depending on the currently selected menu command.

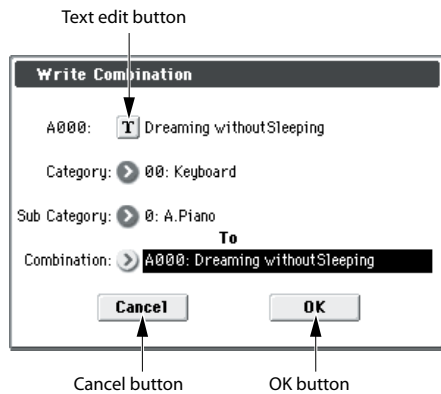

* Text edit button

When you press this button, the text edit dialog box appears for changing the names of Programs, Combinations, Songs, etc. For details, please see “Editing names” on page 91.

Cancel and OK buttons

After performing the other operations in the dialog box, you can execute the command by pressing the OK button. To cancel without executing, press the Cancel button. (The operation will occur when you press and release the button.) The dialog box will close.

The EXIT switch corresponds to the Cancel button, Done button, and Exit button.

j: Radio buttons

Press a radio button to select one value from two or more choices.

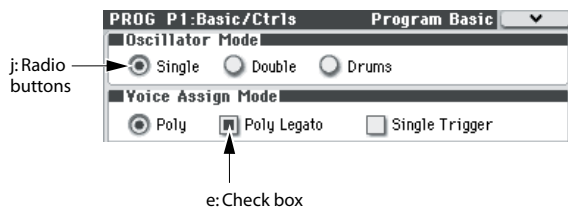

k: Other objects

To modify the parameter value of an object shaped like a slider or knob, first touch the object, and then use the VALUE controllers to modify the value. There are also buttons which execute an operation when they are pressed and released, such as Done, Copy, and Insert (similar to the OK and Cancel buttons explained under “* Dialog box,” above).

Toggle buttons

This type of button will change its function or switch on/off each time it is pressed.

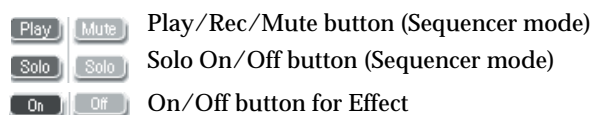

Basic Information

About the M50's modes

The M50 has numerous functions that let you play and edit programs or combinations, record and play back sequence data, and manage media. These functions are grouped into "modes." The M50 has five modes.

Program mode

Programs are the basic sounds of M50.

In Program mode, you can:

- Select and play Programs
- Use one arpeggiator in your performance.
- Play back Drum Track patterns while you perform using a Program.
- Edit Programs
You can use the control surface and the Tone Adjust function to easily edit the program. You can adjust the parameters and settings of the oscillators, filters, amps, EGs, LFOs, effects, arpeggiator, drum track, etc.
You can use up to five insert effects, two master effects, and one total effect.
The oscillators can use any of the 1,077 multisamples (including seven stereo)
- Plus, you can create drum programs using drum kits (as created in Global mode)

Combination mode

Combinations are sets of up to 16 programs that can be played simultaneously, letting you create sounds more complex than a single Program. In Combination mode, you can:

- Select and play Combinations
- Use two arpeggiators in your performance.
- Use one or more timbres to play back the patterns in the drum track.
- Use the M50 as a 16-track multitimbral tone generator
- Edit Combinations
You can assign Programs to each of the 16 Timbres, each with separate volume, pan, EQ, and keyboard and velocity zones; make settings for effects, arpeggiator, drum track.
- Plus, you can use up to five insert effects, two master effects, and one total effect.

Sequencer mode

Sequencer mode lets you record, playback, and edit MIDI tracks. You can:

- Use the sixteen-track MIDI sequencer to record and play back songs.
- Record a single MIDI track at a time, or record as many as all sixteen tracks simultaneously. You can also record exclusive messages.
- Record using two arpeggiators.
- Use one or more tracks to play back the patterns in the drum track.
- Use up to 128 songs, with 671 preset patterns and 100 user patterns for each song.
- Use the M50 as a 16-track multi-timbral sound module.
- Use the Tone Adjust function to easily edit the program of each track.
- Use up to five insert effects, two master effects, and one total effect.
- Record patterns and assign them to individual keys, using RPPR (Realtime Pattern Play/Recording)
- Create user Drum Track patterns.

Global mode

Global mode lets you make overall settings for the entire M50, and edit drum kits, arpeggio patterns. In Global mode, you can:

- Make settings that affect the entire M50, such as master tune and global MIDI channel
- Create user drum kits, and user scales
- Create drum kits using drumsamples
- Create user arpeggio patterns
- Rename program, and combination categories
- Set the function of the assignable pedals and assignable switches
- Transmit MIDI System Exclusive data dumps

Media mode

You can save or load data using an SD card. In Media mode, you can:

- Save and load Programs, Combinations, Songs, and Global setup data
- Format SD card, copy and rename files, etc.
- Export and import sequences to and from SMF (Standard MIDI Files)
- Use the Data Filer function to save or load MIDI System Exclusive data

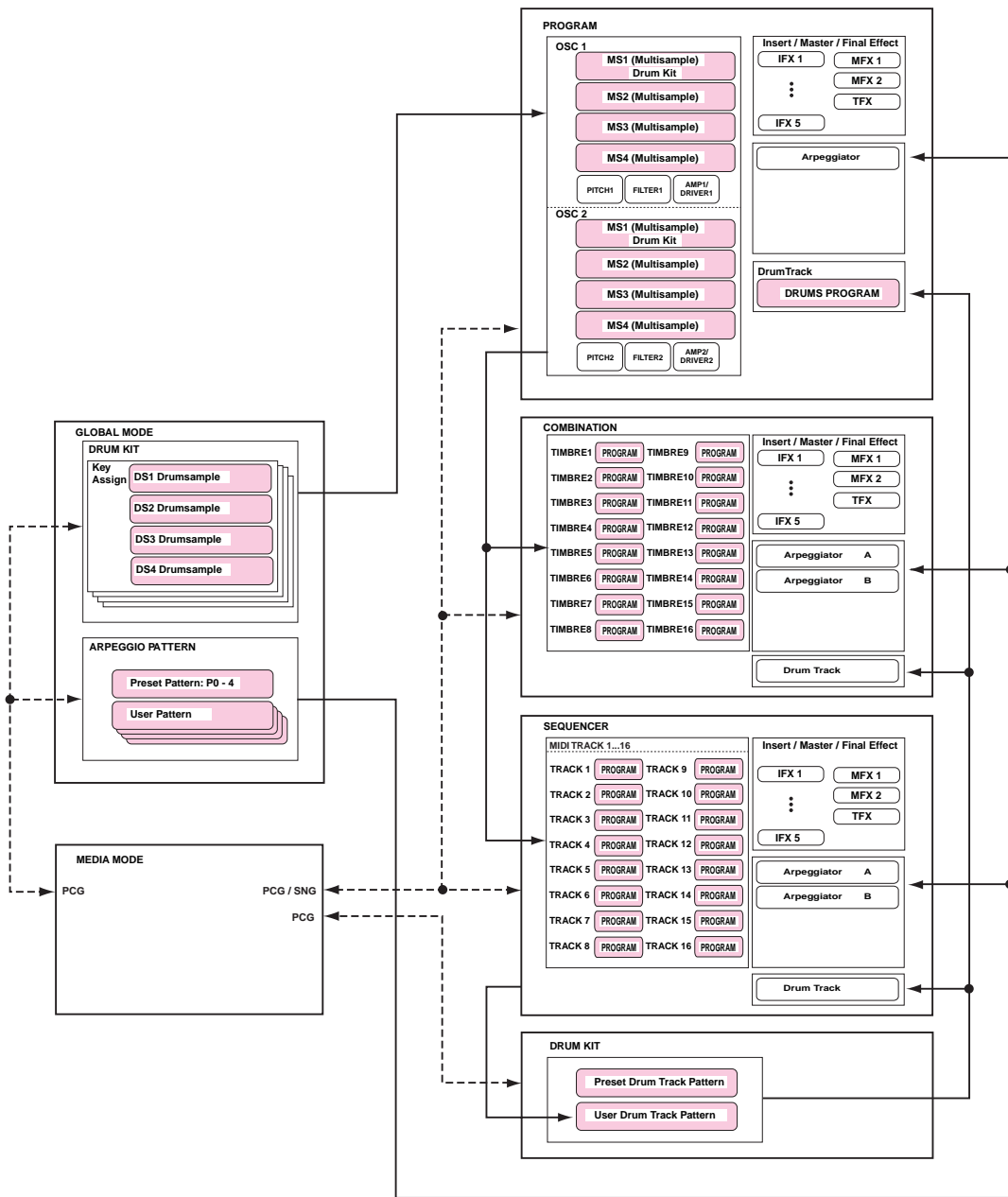

Basic operations

After you've turned on the M50, here's how to perform basic operations such as selecting modes and pages.

Selecting modes

- In order to use a particular function on the M50, you must first select the appropriate mode.

Press one of the front panel mode switches to enter the corresponding mode.

COMBI switch: Combination mode
 PROG switch: Program mode
 SEQ switch: Sequencer mode
 GLOBAL switch: Global mode
 MEDIA switch: Media mode

Selecting combinations, programs, or songs

Normally you will use the P0 screen page when you play a combination or program. This screen also lets you edit the sound in simple ways.

By pressing the EXIT switch several times you can access **Combination Select** or **Program Select**, which displays the combination name or program name. Use a VALUE controller such as the Δ ∇ switches or the VALUE dial to select a number, and use PROG BANK A–GM or COMBI BANK A–D to change banks. For details, please see “Selecting Programs” on page 27 or “Selecting Combinations” on page 43. For details on selecting songs, see “Playback” on page 53.

Selecting pages and tabs

Each mode has a large number of parameters, which are grouped into pages. These pages are further subdivided by tabs; with up to eight tabs per page.

- Make sure that the desired mode is selected. For details on selecting a mode, see “Selecting modes,” above.

In this explanation we'll use Combination mode as an example.

Press the COMBI switch.



Note: The Combi P0: Play page will appear. (This is shown in the upper left of the display.)

Selecting a page

In Combination, Program, Global, and Sequencer modes, you can press the PAGE SELECT switch to view a list of the pages that make up that mode.

- Press the PAGE SELECT switch.

The page select menu will appear.

The page selected before you pressed the PAGE SELECT switch will be greyed as an indication.

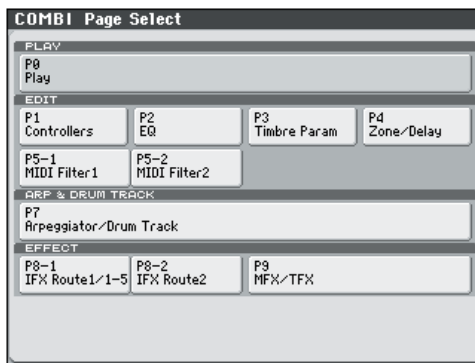

- Press the page that you want to view.

As an example here, try selecting “P4 Zone/Delay.” The P4: Zone/Delay– Key Z T01–08 page will appear.

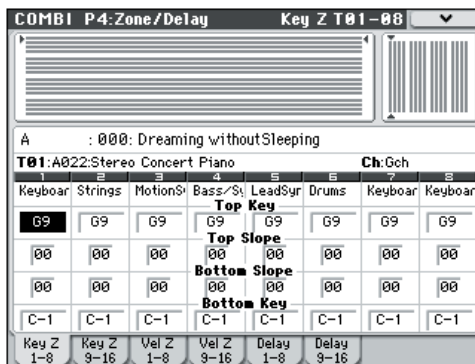

Note: The page that appears will be showing the tab that you most recently selected.

Using the PAGE SELECT switch plus the numeric keys 0–9 to access different pages

- Hold down the PAGE SELECT switch and use numeric keys 0–9 to specify the page number you want to view.

The specified page number will appear. The page that appears will be showing the tab that you most recently selected.

Note: In pages consisting of multiple pages such as P5–1, P5–2, P8–1, and P8–2, the first page (P5–1, or P8–1) will be selected.

Using the EXIT switch to move between pages

If you're in a page other than page 0 (e.g., Prog P0: Play) of each mode, pressing this switch will take you to page 0.

This switch makes it easy to return to the main page of the current mode:

- Press it once to go to the previously-selected tab on the main P0: Play page (Play/REC page in Sequencer mode).
- Press it again to go to the first tab on the main P0: Play page (such as the main Program Play page). If you had previously selected a parameter on this page, that parameter will be selected.
- Press it a third time to select the main parameter on the P0: Play page, such as the Program name in Program mode.

Wherever you are in Program, Combination, or Sequencer modes, pressing EXIT two times (or fewer) will take you back to Program/Combination/Song Select, where you can immediately use the numeric keys or Δ/∇ switches to select a Program, Combination, or Song.

When a dialog box is open, this switch cancels the settings made in the dialog box and closes the dialog box, just like pressing the Cancel button.

If a popup menu or menu is open, pressing EXIT closes the menu.

Selecting tabs

- You can access tabbed pages by pressing the tabs shown in the bottom line of the display.

This example shows the Program T01-08 page through Mixer T01-08 page of Combi P0: Play.



Selecting a parameter and editing the value

1. Press the parameter that you want to edit.

It will be highlighted. (This is called the “edit cell.”)

2. To modify the parameter value in the edit cell, use the VALUE controllers (VALUE dial, Δ/∇ switches, numeric keys 0-9, - switch, (.) switch, and ENTER switch).

Note: The way in which the value will change depends on the type of parameter or object.

For example in the case of a check box object, you can switch the value by pressing that object. You can use the PROG SELECT switches to specify the bank for

programs etc., or hold down the ENTER switch and press a note on the keyboard to enter a note or velocity value (“keyboard input”).

3. You can use knobs 1-4 to edit parameters that are assigned to the control surface.

Note: You can use the COMPARE switch to compare the sound you're editing with the original unedited sound.

VALUE slider

This edits the value of the selected parameter. This slider is convenient when you want to make large changes in the value, or for approximate editing.

You can also use the slider as a modulation source.

Δ/∇ switches

Use these when you wish to make small changes in the value.

VALUE dial

Use this dial to edit the selected parameter's value. This control is convenient when you want to scroll through a very long list of selections.

Numeric keys 0-9, ENTER switch, - switch, (.) switch

These switches are convenient when you know the exact value that you want to enter. Use the 0-9, -, and decimal (.) switches to enter the value, and then press the ENTER switch to confirm the entry.

The - switch inverts the sign (+/-) of the parameter value; the decimal (.) switch inserts a decimal, for entering fractional values.

Functions that use the ENTER switch in conjunction with another switch

ENTER has a few special functions when it is pressed in combination with other switches.

Whenever a parameter on the display lets you enter a musical note (such as G4 or C#2), or a velocity level, you can enter the note or velocity directly by holding down ENTER while playing a note on the keyboard. (This is not available in menu command dialog boxes.)

By holding down the ENTER switch while you press a numeric key (0-9), you can select up to ten menu commands from within the current page.

In Program and Combination modes, you can hold down the ENTER switch and press the SEQUENCER REC/WRITE switch to use the Auto Song Setup function. This imports the current Program or Combination into Sequencer mode for quick and easy recording.

While a dialog box is displayed, the ENTER switch corresponds to the OK button. (The EXIT switch corresponds to the Cancel button.)

In Sequencer mode, you can hold down the ENTER switch and press the LOCATE switch to operate the menu command **Set Location**.

Other

PROG BANK A, B, C, D, E, GM/ COMBI BANK A, B, C, D switches

Use these switches to change banks when selecting Programs or Combinations. The LEDs in the switches light up to show the current bank.

In Program mode, these switches select the Program bank.

In Combination mode, these switches have two functions:

- When you're selecting Combinations, they choose the Combination bank.
- When you're assigning a Program to a timbre within the Combination, they select the Program bank.

In Sequencer mode, when a track's Program name is selected, these switches change the Program bank.

TEMPO knob, TAP TEMPO switch

You can set the tempo by turning the TEMPO knob or by repeatedly pressing the TAP TEMPO switch.

Control surface

For details on using the control surface to edit values, please see page 30.

COMPARE switch

You can use this switch to return the settings of an edited program, combination, or song to their original state. Refer to the following section.

Compare function

Use this when you wish to compare the edits you have made to a program or combination's sound with the un-edited original (i.e., the sound that is written into memory).

When editing a program or combination, press this switch. The LED will light, and the last-written settings for that program number or combination number will be recalled. When you press the COMPARE switch once again, the LED will go dark and you will return to the settings that you were editing.

If you edit the settings that are recalled by pressing the COMPARE switch (i.e., the settings that are written into memory), the LED will go dark, and it will not be possible to return to the previous edits by pressing the COMPARE switch again.

In Sequencer mode, you can use the COMPARE switch to make "before and after" comparisons immediately after using realtime recording or step recording to record a song, or after performing a track edit operation.

For example, this can be used effectively when realtime-recording a MIDI track for a song.

1. **Realtime-record a MIDI track. (Take 1)**
2. **Once again, realtime-record on the same track. (Take 2)**
3. **Press the COMPARE switch. The LED will light, and take 1 will be recalled.**
4. **Press the COMPARE switch once again. The LED will go dark, and take 2 will be recalled.**

5. **If at step 3 you once again realtime-record on the same track (take 3), the object of the Compare function will now be take 1.**
6. **If at step 4 you once again realtime-record on the same track (take 3), the object of the Compare function will be take 2.**

In this way, the Compare function lets you recall the previous recording or the previous state of event editing.

Note: If you continue editing when the COMPARE switch is lit, the switch will go dark. This now becomes the musical data that will be selected when the COMPARE switch is dark.

For details, please see "The Compare function" on page 127 of the Parameter Guide.

⚠ The Compare function that brings back the settings prior to editing is not available in Global mode.

Selecting and executing menu commands

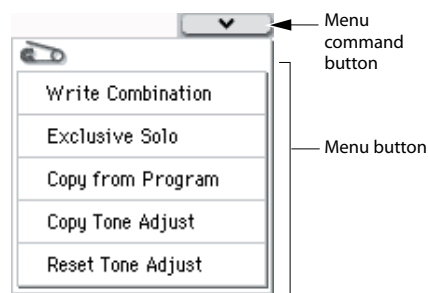

The utility functions provide commands that are specific to each page, such as Write (save) or Copy. The available utility functions will depend on the selected page.

For example, the utility functions in Program mode let you write (save) the settings, or let you perform convenient editing operations such as copying settings between oscillators or effects, or a Sync function that lets you edit two EGs together.

1. **In the upper right of the display, press the ▾ button.**

The menu command will appear.

2. **Select a menu command by touching it with your finger.**

A dialog box for the selected menu command will appear.

Check-type commands will not display a dialog box; their status will be switched, and the list will close.

By holding down the ENTER switch and pressing a numeric key 0–9 you can access the dialog box for the first ten utility functions without going through the menu.

- If you want to close the list without selecting a command, press the display somewhere other than the list, or press the EXIT switch.
3. **For a parameter in a dialog box, select it by pressing it with your finger, and use the VALUE controllers (e.g., VALUE dial or △/▽ switches) to enter its value.**

When selecting a program or combination number in a dialog box, you can also use the BANK SELECT switch to enter the bank as an alternative to using the VALUE controllers.

4. To execute, press the OK button or the ENTER switch.

If you decide not to execute, press the Cancel button or the EXIT switch.

The dialog box will close.

Writing/saving

After editing, you should write or save your changes as necessary.

For example if you've edited a program, your changes will be lost if you select another program or turn off the power. The same applies to a combination.

Settings you edit in Global mode will be remembered as long as the power is on, but your changes will be lost when you turn off the power, unless you write these changes into memory.

For details on the Write operations, see the following pages.

- Programs → p.33
- Combinations → p.46
- Effect presets → PG p.77
- Global settings (pages 0–4) → p.89
- Drum kits → p.89
- User arpeggio pattern → p.89
- User Drum Track patterns → PG p.208
Preset/user Drum Track patterns are saved in internal memory even when the power is turned off. Patterns you create in Sequencer mode can be converted into user Drum Track patterns and saved in internal memory.
- User template songs → PG p.192
Preset/user template songs are saved in internal memory even when the power is turned off. Track settings and effect settings of a song you create can be saved in internal memory by the menu command **Save Template Song**.

For details on writing to internal memory → p.88

Refer to the following pages for more about saving.

- Saving to media (Media– Save) → p.91

Note: On the M50, the action of writing to internal memory is called “Write,” and the action of saving to an SD card device is called “Save.”

Assigning a name (renaming)

You can edit the name of an edited program, combination, song, drum kit, or arpeggio pattern.

You can also change the names of the program and combination categories.

For details, please see “Editing names” on page 91.

Using Controllers

In addition to using the keyboard, the M50 lets you control the sound by using the joystick, SW1 and SW2 switches, knobs 1–4, chord trigger switches, damper pedal, and foot switch or foot pedal.

These controls let you modify the tone, pitch, volume, effects, etc. in realtime as you play.

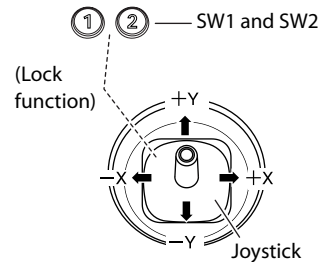

Joystick

The joystick moves in four directions: left, right, up (away from yourself), and down (towards yourself). Each of the four directions can be used to control a different function, such as modulating Program or effects parameters. These assignments can be different for every Program, but generally, they do the following:

Standard Joystick functions

Move the joystick...	Controller Name	Normally controls...
Left	JS-X	Pitch bend down
Right	JS+X	Pitch bend up
Up (away from yourself)	JS+Y	Vibrato
Down (towards yourself)	JS-Y	Filter LFO (wah)

Joystick Lock

The joystick will automatically return to the center position when you release it.

You can use the SW1/SW2 switches or a foot switch connected to the M50 to lock the current position so that the effect will continue even after the joystick returns to the center position. For details, please see “Using the Lock function” on page 20.

SW1, SW2

You can use these switches to control program parameters via AMS (Alternate Modulation), or effect parameters via DMod (Dynamic Modulation).

They can also transpose the keyboard by octaves, turn portamento on/off, or to lock the position joystick.

Each switch can work as either a **Toggle** or **Momentary** switch. In **Toggle** mode, the assigned function is switched between on and off each time the switch is pressed. In **Momentary** mode, the assigned function is active on only as long as you hold down the switch.

In Program mode, you can check the assignments of SW1 and SW2 on the Prog P0: Play– Main page.

For details, please see “Controller settings for the program” on page 29.

When you write a Program or Combination, the on/off status of the SW1 and SW2 switches is saved.

For details, please see “Setting the functions of SW1 and SW2” on page 18 of the Parameter Guide.

Using the Lock function

Locking the Joystick

1. Using the standard factory sounds, select Program A033: Mild Suitcase E.Piano, and play the keyboard.

To select a program, make sure that you are in Program mode, and press the PROG BANK A switch, numeric key 3, 3, and then the ENTER switch.

2. Move the joystick away from yourself (the +Y direction).

The vibrato effect will deepen.

3. While holding the joystick away from yourself, press the SW2 switch.

When you press the switch, its LED will light up, and the modulation effect at this point will be maintained.

4. Release the joystick, and play the keyboard.

The modulation will stay the same as it was when SW2 was pressed. Moving the joystick away from yourself will not affect the sound.

5. Press the SW2 switch once again to release the Lock function.

Keyboard

Velocity

Velocity is a measure of how hard you play a note on the keyboard. This can be used to modulate many different aspects of the sound, such as volume, brightness, or the character of the attack.

Note Number

Sounds can be programmed to change in character based on the note being played.

As you play higher or lower on the keyboard, the note number can modulate the timbre—such as becoming brighter as you play higher. Envelopes may also become faster or slower; the volume may change; and so on.

Control Surface knobs

The control surface consists of four knobs, three control assign switches REALTIME CONTROLS, EXTERNAL, and ARP that select the functions that will be controlled, and the RESET CONTROLS switch which resets each function.

- You can apply modulation to sounds or edit them.
- You can control the arpeggiator.
- You can control external MIDI devices.

1. Press one of the REALTIME, EXTERNAL, or ARP switches to select the group of functions that you want to control.

Alternatively, you can use the Prog P0: Play- Control Surface page **Control Assign** parameter to select a function. Press the Control Surface tab in the lower line of the display to access this page.

Since this parameter is linked with the front panel switches, a change you make to one will be reflected by the other.

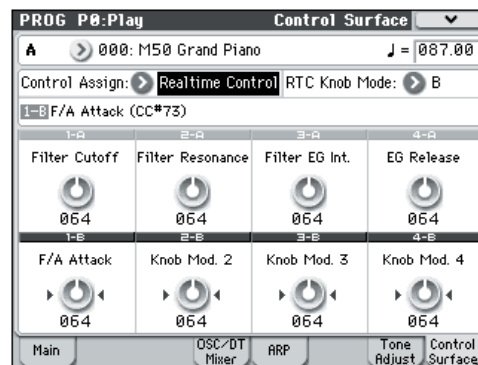

In Program mode, you can select one of three different functions:

Realtime Control: Use the knobs to modify the sound or effects. For details, please see “Setting the functions of Realtime Control B mode knobs 1–4” on page 19.

External: Use the sliders and switches to transmit MIDI messages to external MIDI devices. You can assign these functions in the Global P1: MIDI- External Mode 1/2 pages.

ARP: Use the knobs to control the arpeggiator.

You can freely switch between these functions without losing your current edits.

2. Operate knobs 1–4 to control the selected functions.

⚠ At the minimum and maximum positions of the knob, there will be a slight discrepancy between the value and the position of the knob.

For details on control surface operation in each mode, refer to the following pages.

Program mode: for details, please see “0–8: Control Surface” on page 11 of the Parameter Guide

Combination mode: for details, please see “0–8: Control Surface” on page 87 of the Parameter Guide

Sequencer mode: for details, please see “0–2–8: Control Surface” on page 143 of the Parameter Guide

Resetting the controller settings

You can reset the controllers of the control surface, or switch to saved values.

To reset an individual control, hold down the RESET CONTROLS switch and operate the control surface knob that you want to reset.

1. **While holding down the RESET CONTROLS switch, operate the knob 1–4 that you want to reset.**
2. **When the knob has been reset, release the RESET CONTROLS switch.**

Note: If you reset REALTIME CONTROL, the knob will be at the center (064).

To reset all of the knobs in a certain control assign group, hold down the RESET CONTROLS switch and press the desired CONTROL ASSIGN switch.

- While you hold down the RESET CONTROLS switch, press the REALTIME CONTROL–ARP switch that is shown in the display (the LED will be lit).

The settings will be reset to the values that are written in the program or combination. A sequencer song will be reset to its state when you entered the mode, when you selected the song, or immediately after you executed a command such as **Copy From Combi**.

Chord Trigger Switches

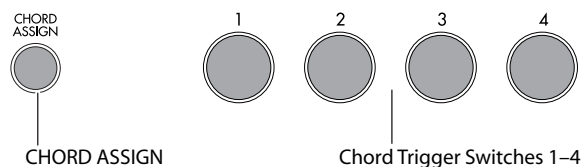

Four chord trigger switches are located below the display.

You can use these to trigger single notes or chords (up to eight notes).

These are an effective way to play chords or to play the arpeggiator. You can assign the notes and velocities transmitted by each switch.

Playing the chord trigger switches

1. **Press a chord trigger switch.**

One or more notes of the specified note number and velocity will be transmitted according to the assignment of that switch.

The assigned note numbers will also be transmitted when you use CHORD ASSIGN to assign notes to a switch.

Assigning notes and chords to chord trigger switches

You can assign single notes and chords to the chord trigger switches in three different ways.

Selecting the notes first

1. **Play a single note, or a chord of up to 8 notes.**
2. **Press the CHORD ASSIGN switch.**

3. **Press the chord trigger switch to which you'd like to assign the notes.**

That's it! The notes are now assigned to the chord trigger switch.

Press CHORD ASSIGN, and then play notes

This method lets you create a chord out of widely-spaced notes, even if you can't play all of the notes simultaneously.

1. **Press the CHORD ASSIGN switch.**
2. **Play a single note, or a chord of up to 8 notes.**

You can play a single note, or a simple chord.

If you like, you can also enter a chord by playing up to 8 notes as a legato phrase. As long as you take care that the notes overlap each other, the entire series of notes will be recorded as a single chord. You can take as long as you like to play the phrase.

3. **Press the chord trigger switch to which you'd like to assign the notes.**

After pressing the switch, you're done!

- **Editing notes and velocities using the display.** You can edit the recorded notes and velocities using the display. If you like, you can also enter new notes this way. For details, please see "1–8: Chord Trigger Setup" on page 20 of the Parameter Guide.

Copying/merging chord trigger switches

In the same way as you can assign notes to a chord trigger switch by pressing keys on the keyboard, you can also copy the existing assignments from another chord trigger switch by simply pressing that switch. You're also free to copy the assignments of two or more switches together (up to eight notes). For details, please see "Copying notes from one chord trigger switch to another" on page 20 of the Parameter Guide.

VALUE slider

When a program number is selected in Prog P0: Play page, or when a combination number is selected in Combi P0: Play page, you can use the VALUE slider to modulate Program and effects parameters.

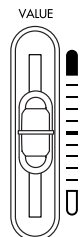

TEMPO knob and TAP TEMPO switch

This adjusts the tempo for the M50 as a whole, including:

- Arpeggiator
- Drum Track
- Songs in Sequencer mode
- Tempo-synced LFOs
- Tempo-synced ("BPM") delay effects

TEMPO knob

The LED will blink at quarter-note intervals of the current tempo.

Note: If the Global P1: MIDI– MIDI Basic page **MIDI Clock** parameter is set to External MIDI, External USB, or if it is set to **Auto** and a clock is currently being

received via MIDI, then neither the TEMPO knob nor the TAP TEMPO switch will have any effect.

TAP TEMPO switch

You can set the tempo of the Arpeggiator or Drum Track function in Program, Combination, and Sequencer modes by lightly pressing or tapping the TAP TEMPO switch several on the beat. In Sequencer mode, you can control the song tempo in this way.

To enter the tempo, use your finger to gently tap the TAP TEMPO switch. The tempo will be entered when you press the switch twice, but you should tap several times in order to increase the precision. The average of the last sixteen taps will be specified as the tempo.

During playback, lightly press the TAP TEMPO switch several times at the desired tempo. The tempo will follow your tapping in realtime. This is a convenient way to match the tempo in realtime to the beat of a different source.

 You can use tap tempo control whenever the TEMPO knob can be operated. For example in Sequencer mode, tap tempo control will not be available if you are playing a song whose **Tempo Mode** setting is set to Auto. (See PG page 130)

Note: You can also use a foot switch connected to the ASSIGNABLE FOOT SWITCH jack to control the tap tempo function (see page 84, PG page 228, and page 384).

Damper Pedal

The damper pedal is also sometimes called the sustain pedal. It acts like the similarly-named pedal on an acoustic piano; when you hold down the pedal, notes will continue to sustain even when you lift your hands off of the keyboard.

In Combination and Sequence mode, you can also make settings so that the damper will affect some sounds but not other sounds.

Foot Switch

Assignable Foot Switch

This lets you use a simple footswitch, such as the Korg PS-1, as an assignable controller. The footswitch can perform a wide variety of functions, such as:

- An assignable source for modulating sounds and effects
- Portamento on/off
- Program select up or down
- Sequencer start/stop or punch in/out
- Tap Tempo
- Arpeggiator on/off
- Switch the Drum Track on/off
- Operate various M50 controls (VALUE slider, chord trigger switches, realtime control knobs, joystick, SW1/SW2, etc.)

Assignable Foot Pedal

This lets you use a continuous controller pedal, such as the Korg EXP-2 foot controller or Korg XVP-10 EXP/VOL pedal, as an assignable controller.

Like the Assignable Foot Switch, described above, the Foot Pedal can be used for many different functions, including:

- Master Volume
- Channel Volume, Pan, or Expression
- Assignable sound modulation, as several different AMS or Dmod sources
- Effects Send level control
- Operate various M50 controls (VALUE slider, chord trigger switches, realtime control knobs, Joystick, SW1/SW2, etc.)

Setup

Turning the power on/off

Connecting the AC adapter

Connect the AC adapter to the M50. For details on this connection, please see “Setup” on page 1.

- ⚠ You must use only the included AC adapter. Using any other AC adapter may cause malfunctions.

Turning the power on

1. Lower the M50's VOLUME slider.

If you have connected powered monitor speakers or a stereo amp, turn down the volume of these devices.

2. Press the rear panel Power switch to turn on the power.

The display will show the model name and software version. (The following graphic shows the factory-set display. The version number is subject to change without notice.)

3. Turn on your powered monitors or stereo amp.
4. Raise the M50's VOLUME slider to an appropriate position, and adjust the volume of your powered monitor speakers or stereo amp.

Note: The state of M50 when the power is turned on will depend on the setting of **Power On Mode**. (See page 84)



Turning the power off

- ⚠ After you've finished editing, be sure to write (save) your changes.

If you edit a program and then select a different program or turn off the power, the changes you made will be lost. The same is true for a combination.

The settings you edit in Sequencer mode and Global mode are remembered as long as the power is on, but will be lost when you turn off the power, so be sure to save all your data before turning the power off.

1. Lower the M50's VOLUME slider.

Also turn the volume of your powered monitor speakers or stereo amp down to zero.

2. Turn off the power of your powered monitor or stereo amp.

3. Press the rear panel Power switch to turn off the power.

- ⚠ The display will indicate “Now writing into internal memory” while data is being written into internal memory. You must not turn off the power while this indication is shown.

If the power is turned off while data is being written, memory write operations will not be completed correctly. If this occurs, M50 will automatically initialize its internal memory so that it will operate correctly. This is not a malfunction. In this case, the display will indicate following message; press the OK button.

The internal memory has been corrupted, likely due to an interruption of power while the system was writing/saving data. This has been repaired and the affected Bank has been initialized.

Connections

⚠ Connections must be made with the power turned off. Please be aware that careless operation may damage your speaker system or cause malfunctions.

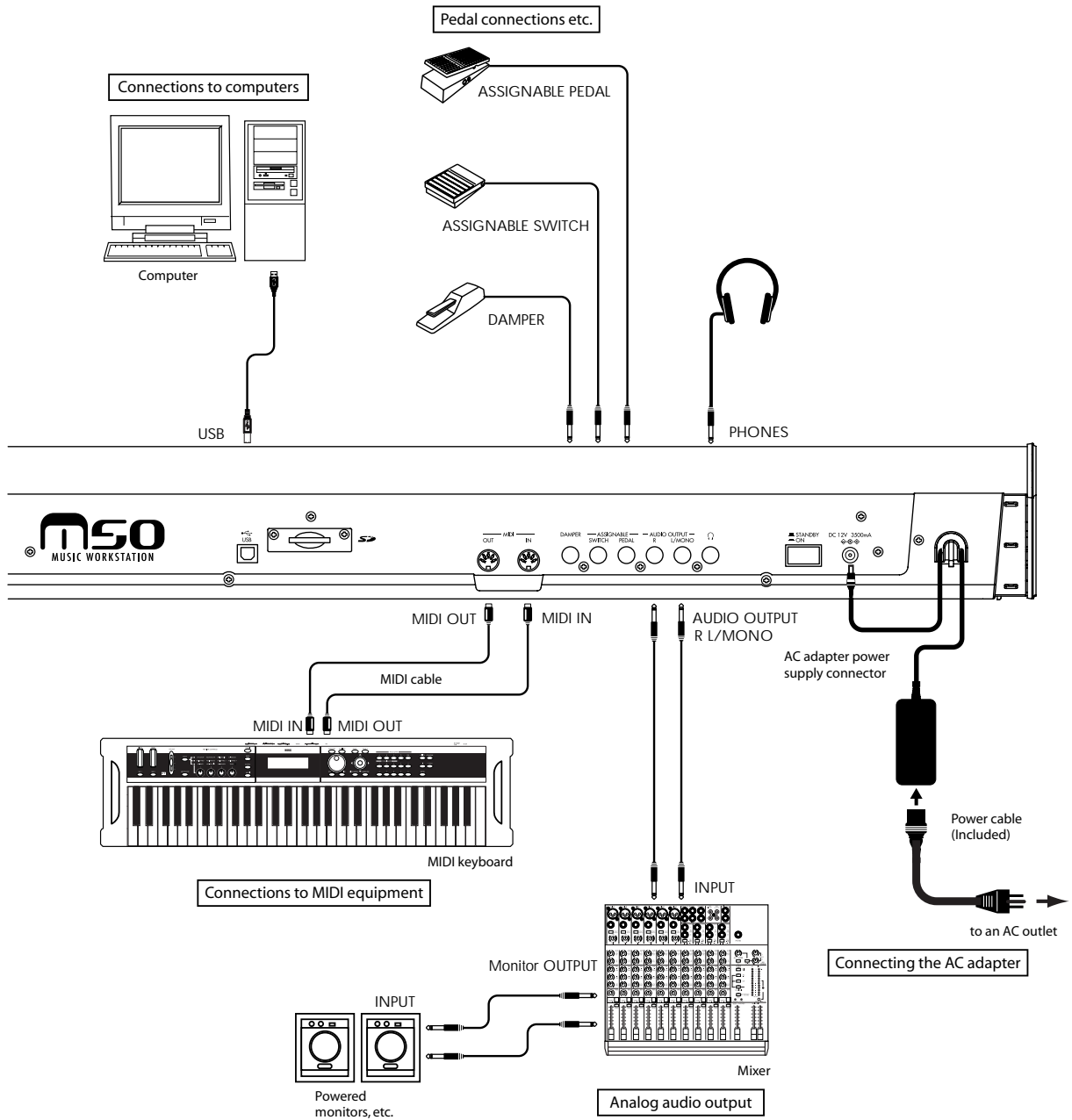

Connecting audio equipment

Here's how to connect the M50 to your analog amp or mixer.

- ▲ If you've connected a stereo audio amp, be aware that playing at high volume may damage your speaker system. Be careful not to raise the volume excessively.

AUDIO OUTPUT L/MONO and R

These are the main outputs, accessed by setting **Bus Select** to L/R. All of the factory sounds use these outputs, and the Master and Total Effect are always routed here as well.

1. **Connect the AUDIO OUTPUT L/MONO and R outputs to the inputs of your powered monitor or mixer.**

If you're using M50 in stereo, use both the L/MONO and R jacks. If you're using M50 in mono, use only the L/MONO jack.

If you're playing back through a stereo audio amp or a radio cassette recorder that has an external input jack, connect the M50 to the jack(s) labeled LINE IN, AUX IN, or external input. (Use an adapter cable with the appropriate type of plug.)

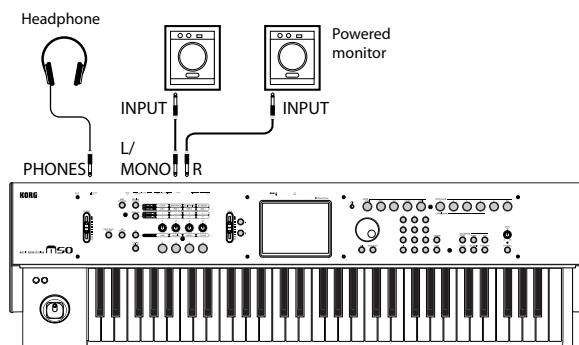

Headphones

1. **If you're using headphones, connect them to the M50's headphone jack.**
2. **Use the VOLUME slider to adjust the volume of the headphones. The M50's headphone jack outputs the same signal as the AUDIO OUTPUT L/MONO and R jacks.**

Connecting a damper pedal, foot switch, or foot pedal

By connecting an optional damper pedal, foot switch, or foot pedal, you can control even more functions and effects.

You can use the damper pedal to apply a damper effect while you play.

You can use the foot switch to turn the sostenuto or soft pedal effect on/off, to turn the arpeggiator on/off, to switch programs or combinations, or to control tap tempo.

You can use the foot pedal to control volume or modulation.

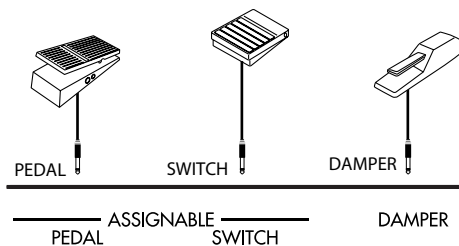

Connecting a damper pedal

This pedal can provide a damper effect as you play. This instrument also supports half-damping. Here's how to connect an optional Korg DS-1H damper pedal to the DAMPER jack and use it to control the half-damper effect.

1. **Connect an optional DS-1H damper pedal to the DAMPER jack.**

You'll be able to control the half-damper effect if you've connected the DS-1H. If you've connected a different switch-type pedal, it will function as a damper switch.

2. **After you turn on the power, set the switch polarity and adjust the half-damper response to ensure that the half-damper pedal works correctly. (See PG page 228, and page 252)**

Connecting a foot switch

If you connect an on/off-type foot switch such as the Korg PS-1 pedal switch to the ASSIGNABLE SWITCH jack, you can use it to turn the sostenuto or soft pedal effect on/off, to control tap tempo, or to apply modulation to a sound or an effect.

This switch will always function in the same way regardless of the Program, Combination, or Song you've selected. You can assign the function in the Global mode.

1. **Connect a foot switch such as the optional PS-1 to the ASSIGNABLE SWITCH jack.**
2. **After turning the power on, use Global P2: Controllers–Foot Controllers page “Foot Switch Assign” and “Foot Switch Polarity” to assign the function controlled by the foot switch and to specify the polarity. (See page 84, PG page 228, and page 384)**

Connecting a foot pedal

If you connect an optional EXP-2 foot controller or XVP-10 expression/volume pedal to the ASSIGNABLE PEDAL jack, you can use it to apply modulation to sounds or effects, or to adjust the overall volume.

This pedal will always function in the same way regardless of the Program, Combination, or Song you've selected. You can assign the function in the Global mode.

1. **Connect an optional XVP-10 or EXP-2 to the ASSIGNABLE PEDAL jacks.**
2. **After turning the power on, use Global P2: Controllers- Foot Controllers page "Foot Pedal Assign" to assign the function controlled by the foot pedal. (See page 84, PG page 228, and page 385)**

Connecting the M50 to a computer

The M50 provides both MIDI and USB connectors as standard equipment. By connecting the M50 to your computer via USB, you can use it as a controller and MIDI sound module for your DAW software with single cable convenience; and with out the need for a MIDI interface.

By using the dedicated editor, you can edit the M50 from your computer as though it were a software plug-in.

For details, see "M50 Editor/Plug-In Editor owner's manual" (PDF).

Connecting MIDI devices

By connecting the M50's MIDI connectors to an external MIDI device you can transfer sound settings and performance data such as note messages between your external MIDI device and the M50.

About MIDI

MIDI stands for Musical Instrument Digital Interface, and is a world-wide standard for exchanging various types of musical data between electronic musical instruments and computers. When MIDI cables are used to connect two or more MIDI devices, performance data can be exchanged between the devices, even if they were made by different manufacturers.

Controlling an external MIDI tone generator from M50

If you want to use the M50's keyboard, chord trigger switches and other controllers, sequencer, and arpeggiator to play or control an external MIDI sound module, use a MIDI cable to connect the M50's MIDI OUT connector to the MIDI IN connector of your external MIDI sound module.



Controlling M50's tone generator from an external MIDI device

When you wish to play or control the M50's tone generator from an external MIDI keyboard or sequencer etc., use a MIDI cable to connect the MIDI OUT connector of the external MIDI device to the MIDI IN connector of M50.

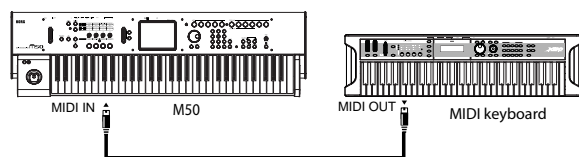

Controlling two or more external MIDI tone generators from M50

You can also use a MIDI patch bay to control multiple MIDI devices.

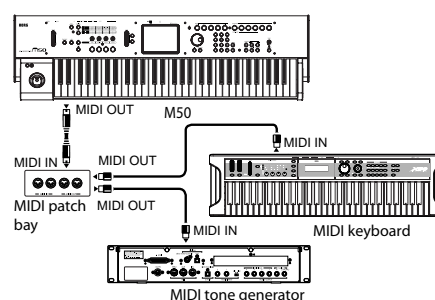

Playing and editing Programs

About the M50's Programs

Programs are the basic sounds of the M50.

You can play them by themselves, layer them together in Combinations, or play a different Program on each of the 16 MIDI tracks, either from the internal sequencer or from external computer-based sequencers.

This section of the manual takes a quick look at playing Programs, including tours of the front-panel controllers and basic editing techniques.

Playing Programs

Selecting Programs

There are several different ways to select Programs. Each one is convenient in a different way:

- Using "Program Select" and the VALUE controllers:
- Using the Bank/Program Select menu:
- Using the Category/Program Select menu:
- Using a foot-switch: PG page 228
- MIDI program change messages let you select Programs remotely: PG page 218, page 220 and page 392

Selecting a program using "Program Select" and the VALUE controllers

1. Press the MODE PROG switch. (The LED will light.)
(Refer to the illustration below for the switches.)

The M50 will enter Program mode.

2. Access the Prog P0: Play- Main page.

This is shown in the top line of the display.

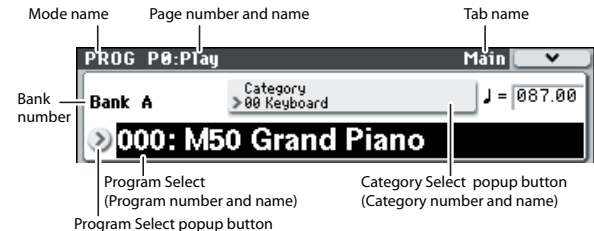

If a different page is shown, press the EXIT switch a few times to return to the Prog P0: Play- Main page.

3. Make sure that "Program Select" is selected.

If it is not, press "Program Select" in the display to highlight it.

4. Select the program you want to play.

You can use the following methods to select a program.

- Use the Δ or ∇ switches.

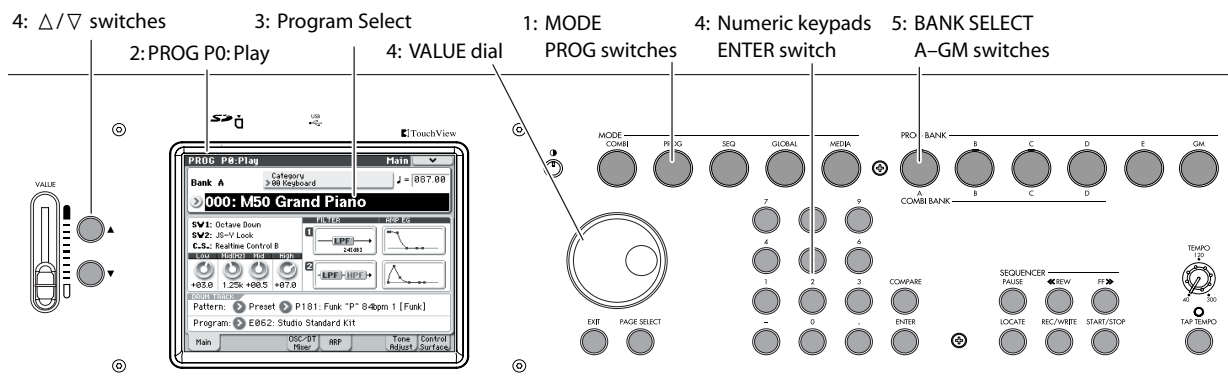

- Turn the VALUE dial.
 - Use numeric keys 0–9 to enter the program number, and press the ENTER switch.
5. Press one of the PROG BANK A–GM switches to select a bank.

When you select a different Bank, the switch’s LED will light, and the selected bank will appear on the left side of the display.

For example, to select bank B, press the PROG BANK B switch. The B switch will light, and the name Bank B will appear in the left of the display.

- Each time you press the GM switch, the bank will alternate as shown below.

GM→g(1)→g(2)→g(3)→g(4)→g(5)→g(6)→g(7)→g(8)→g(9)→g(d)→GM→g(1)→...

Auditioning the sound

Play the M50’s keyboard to audition the program you’ve selected. You can also audition the program by pressing the chord trigger switches.

Overview: Program Banks

With the factory settings, the M50 contains 608 preloaded programs, plus 256 programs and 9 drum programs that are GM2 compatible. In addition to these, you can store sounds that you create, as well as optional sound libraries, giving you a total of 640 programs.

Programs are organized into six banks as shown in the following table.

Program bank contents

Bank	Prog. No.	Explanation	
A...E	000...127 E:000...095	Factory Programs.	With the factory settings, these banks contain a wide variety of preloaded programs that use the internal multisamples, effects, and arpeggiator.
E	096...127	Initialized Programs.	Use these to create a program from scratch.
GM	001...128	GM2 main programs.	These banks contain 256 GM programs and nine GM drum programs that are compatible with the GM2 sound map. The programs of these banks are read-only. Bank GM contains the GM programs. GM lets you select 128 programs numbered from 001–128, and g(1)–g(d) lets you select nine drum programs. You can’t write (save) data to these banks.
g(1)...g(9)	001...128	GM2 variation programs.	
g(d)	001...128	GM2 drum programs.	

Selecting by Bank/Program Select menu

You can select Programs from a menu organized by Program bank.

1. Press the Program Select popup button.

The Bank/Program Select menu appears.

Bank/Program Select menu



In this illustration, Bank A is selected. The menu displays the Programs contained in that bank.

2. Press the tabs in the left of the display to select banks.
3. Press one of the program names in the center area to select a program.

The selected program will be highlighted, and the program will change.

Alternatively, you can use the Δ / ∇ switches to switch programs.

Play the keyboard or pressing the chord trigger switches to hear the program you selected.

4. If you selected Bank GM, the Variation button is shown.

By repeatedly pressing this Variation button you can cycle through the banks in the same way as you would by pressing the front panel GM switch.

5. When you are satisfied with the selected Program, press the OK button to close the menu.

If instead you press the Cancel button, the selection you made here will be discarded, and you will return to the program that had been selected before you opened the menu.

Selecting by Category/Program Select menu

You can select Programs from within a category, such as keyboard, organ, bass, and drums.

When shipped from the factory, the preloaded Programs are organized into 16 categories, each with several sub-categories.

1. Press the Category Select popup button.

The Category/Program Select menu appears.

Category/Program Select menu



In the illustration above, the Keyboard category is selected. The menu in the center column area shows the Programs which belong to that category.

2. Press the tabs to the left and right of the display to select a different category.

The name of the selected category will be displayed in full in the top right-hand corner.

3. Press one of the program names in the center area to select a program.

The selected program will be highlighted, and the program will change.

Alternatively, you can use the Δ/∇ switches to switch programs. Touch the scroll ribbon at the bottom of the screen to see all of the Programs in that category.

Play the keyboard or press a chord trigger switch to hear the program you selected.

4. If you want to select from a sub-category, press the Jump to Sub button to access the Sub Category/Prog Select menu.

Press the left tabs to select a sub-category.

Note: You can't select tabs for a sub-category that has no associated programs.

Select a program as described in step 3 above.

Press the OK button to confirm your selection, or press the Cancel button to discard it. You will return to the main category.

5. When you are satisfied with the selected program, press the OK button to close the menu.

If instead you press the Cancel button, your selection will be discarded, and you will return to the program that had been selected when you opened the popup menu.

Using Controllers

For details on performing with the joystick and the control surface, see "Using Controllers" on page 19.

Controller settings for the program

The Prog P0: Play- Main page lets you view the following information.

SW1, SW2: Indicates the functions controlled by the SW1/SW2 switches.

C.S.: Indicates the currently selected control assign setting. Control via the control surface is active in all pages.

FILTER 1, 2: Indicates the filter type setting for filter 1 and 2.

AMP EG 1, 2: Indicates the EG setting for amp 1 and 2.

EQ (Low, Mid[Hz], Mid, High): Indicates the 3-band EQ settings. You can use the VALUE controller to edit the values.

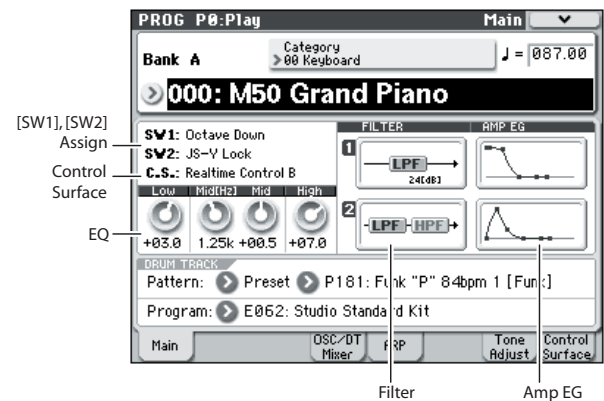

Performing with the arpeggiator or drum track

Based on note data it receives from the keyboard or from the MIDI IN connector, the arpeggiator can generate a wide range of phrases and patterns including arpeggios, guitar or keyboard backing riffs, bass phrases, or drum patterns. You can also use the front panel control surface knobs to vary the length and dynamics of the arpeggiated notes.

For more about the arpeggiator, please see page 73.

The drum track uses a rich variety of drum patterns to play the M50's high-quality drum programs. You can select any program and play along with the drum patterns.

Of course you can also synchronize the arpeggiator and the drum track patterns and use them together.

For more about the drum track, please see page 79.

Easy Program editing

Simple editing using the sliders and knobs

All of the M50's programs can be edited. You can start by editing a preloaded program, or you can initialize a program and create your own from scratch.

It is a lot of work to create the sound you want by starting with an initialized program. It's often more convenient to start with a preloaded program that's close to what you have in mind, and then edit it to your taste. On the M50, you can use the knobs of the front panel control surface to make very effective edits simply from within the Prog P0: Play page.

For example, you can vary the cutoff, resonance, or release time by operating the knobs.

Adjusting the EQ

You can adjust a mid-sweepable three-band EQ in the Prog P0: Play- Main page. This EQ will affect both oscillator 1 and oscillator 2.

1. Access the Prog P0: Play- Main page.
2. In the display, select the EQ that you want to edit.
3. Use the VALUE controllers (e.g., VALUE slider) to edit the value.



Controlling Volume, Mute, and Solo for Oscillators 1/2 and the Drum Track

In the Prog P0: Play- OSC/DrumTrk Mixer page, you can adjust the volume of the oscillators and drum track, and make mute and solo settings.

1. Access the Prog P0: Play- OSC/DrumTrk Mixer page.

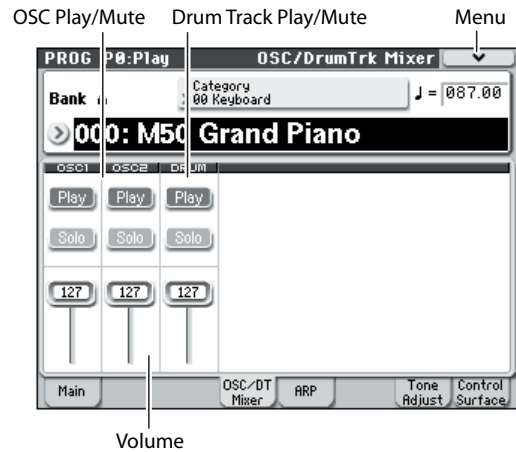

2. Select a slider in the display, and use the VALUE slider etc. to adjust the volume of oscillators 1 and 2 and the drum track.

Note: With single-oscillator programs, you won't be able to control oscillator 2.

3. You can press the Play/Mute button in the display to toggle the Play/Mute status of oscillators 1 and 2 and the drum track.
4. You can press the Solo button in the display to toggle the Solo On/Off status of oscillators 1 and 2 and the drum track.

The operation of the Solo function will switch each time you select "Exclusive Solo" in the menu (see PG page 73).

Using control surface to edit sounds or effects

You can use the control surface to control the sound or effects in real time.

1. Press the control surface REALTIME CONTROL switch (the LED will light).
2. If desired, display the Prog P0: Play- Control Surface page.

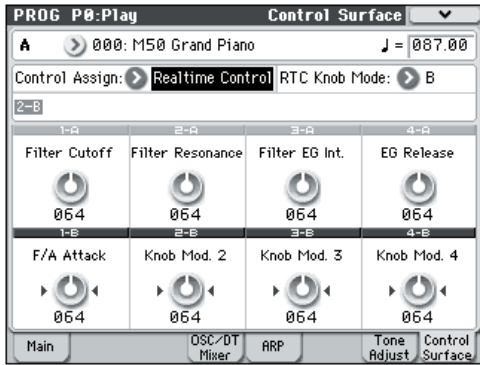

3. There are two modes of realtime control, A and B; these will alternate each time you press the REALTIME CONTROL switch. Each mode lets you use knobs 1-4 to control the assigned parameters.

In A-mode, knobs 1-4 are assigned dedicated functions corresponding to MIDI control changes.

In B-mode, knobs 1-4 can be assigned a variety of functions. Many of these have corresponding MIDI control changes.

When you move a knob, the corresponding MIDI control change message will be transmitted. When a MIDI control change message is received, the value of the knob will change to the value of that control change message.

Normally, the amount of change produced by a knob will depend on the internal settings of the program. When the knob is in the center position, the program will sound according to its own original settings. To change the setting to its maximum value, move the knob all the way to the far right. To change the setting to its minimum value, move the knob all the way to the far left.

Knob scaling

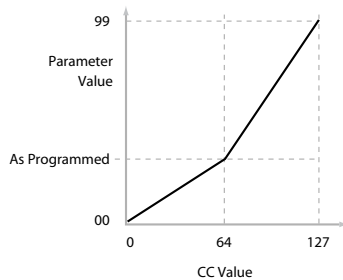

For example:

- 1. Select Program A064, "Smooth Operators."**
This is an electric piano sound; let's see what we can do to make it sound a bit different.
- 2. Press the control surface REALTIME CONTROL switch to select A-mode (the LED will light).**
- 3. While you perform, slowly raise knob 1 (filter frequency) to about three-quarters of its full range.**
Notice how the piano becomes a sort of synth sweep.
- 4. Next, raise knob 2 (filter resonance) to about three-quarters as well.**
- 5. Leaving knob 2 at that position, try raising and lowering knob 1.**

With the resonance increased, it now sounds like you're playing through a wah pedal.

Reset

Next, let's say that you decide that's not really what you wanted—so, we'll set the knobs back to their default values. Although you could return the knob to its middle position and then make fine adjustments to set it precisely to the center, there is an easier way.

- 1. Hold the RESET CONTROLS switch.**
- 2. While holding RESET CONTROLS switch, first move knob 1, and then knob 2.**

As you move the knobs, their values will be reset to the default, center positions.

- 3. Release the RESET CONTROLS switch.**

Now, you're back to the original electric piano sound.

The table below shows the standard assignments of the Control surface Realtime Control knobs:

Knob	MIDI CC	Normally controls...
A-1	74	Filter Cutoff Frequency
A-2	71	Filter Resonance
A-3	79	Filter EG Intensity
A-4	72	EG Release Time
B-1, 2	Varies for each Program	
B-3	Often Chorus Depth - but can vary per Program	
B-4	Often Reverb Depth - but can vary per Program	

Saving the edits you made by moving the knobs

The control surface Realtime Control knobs are great for modulating sounds in performance. If you like, you can also save the edited version of the sound, using the normal Write Program command. For details, please see "Saving your edits" on page 33.

However for Realtime Control B mode knobs 1-4, the edited settings can be saved only if you've assigned CC#70-79.

Internally, a single knob usually affects several different parameters. When you write a Program, the edits are saved into the individual program parameters, and not to the knob itself.

After writing the Program, you'll notice that the knobs have returned to their center positions—since the old "edited" values are now the new "saved" values.

Assigning Realtime Control B-mode functions to knobs 1-4

You can assign the functions that knobs 1-4 will perform when control surface Realtime Control B-mode is selected. (See PG page 19)

Using Tone Adjust

The Tone Adjust function lets you edit the parameters of the program. The program parameters that are most effective for editing will be assigned to the controllers in the display.

1. Access the Prog P0: Play– Tone Adjust page.

This page shows and reflects data generated by the tone adjust, letting you view the parameter assignments and their precise values. This is convenient and informative when adjusting the sound.

2. To edit the sound, select a slider (1–8) or switch (1–8) in the display, and use the VALUE slider etc. to operate it.

Note: You can assign the principal program parameters to the various controllers in the display. For details, please see “0–7: Tone Adjust” on page 6 of the Parameter Guide.

For example:

1. Select Program A064, “Smooth Operators.”

2. Access the Prog P0: Play– Tone Adjust page.

This page mirrors the Control Surface. It’s very useful with Tone Adjust, since it shows you the parameter assignments, exact values, and so on.

3. Look at the assignments for sliders 5, 6, and 8 in the display.

Slider 5 is assigned to **F/A EG Attack Time**; slider 6 is assigned to **F/A EG Decay Time**; and slider 8 is assigned to **F/A EG Release Time**.

4. Raise each of the three sliders so that they are about 4/5 of the way to the top.

The display should show their values as between +60 and +70. This means that you have edited the filter EG and amp EG attack, delay, and release to longer values.

5. Play a few notes.

Notice that the sound has changed from an electric piano into a soft pad. Next, let’s add just a bit of filter modulation, to make the sound more rich.

6. Notice the assignment of slider 2 in the display.

Slider 2 is assigned to “[OSC1] Filter LFO1 Int A” (OSC1 filter LFO1 intensity). It will adjust the amount of filter modulation produced by LFO1.

7. Lower slider 2 slightly so that the display indicates about –6.

8. Play a few more notes.

The filter modulation has added some shimmer to the sound. Now, maybe it could use a bit more edge...

9. Look at the assignments for switches 6 and 7 in the display.

These are programmed to raise the **Filter Cutoff** and **Filter Resonance**, respectively. Switches are just on/off, but you can set a specific value for the **On** position; notice the +10 and +40 in the switch’s value boxes.

10. Press each of the two switch buttons.

The sound now has a more interesting character, due to the filters. Since it’s brighter, we’ve also restored some of the electric piano character.

Pretty easy, huh? Note: depending on the parameter, you may sometimes hear glitches in the sound as you move the control.

Changing parameter assignments

The factory Programs include default assignments of Tone Adjust parameters to the sliders, and switches in the display. If you like, you can change any of the assignments. To do so:

1. Access the Prog P0: Play– Tone Adjust page.

2. Press the popup button located at the left of the assigned parameter.

A popup window will appear, with a long menu of parameters. You can tell various things about the selections, just from the way they appear in the menu:

Parameters which affect only OSC1 or OSC2 are prefixed with [OSC1] and [OSC2], respectively.

Parameters which affect both Oscillators, but which are specific to Programs, are prefixed with [OSC1&2].

The other group of parameters, at the beginning of the list, are “Common.” That is, you can use them with most Programs.

Parameters can only be assigned to one Tone Adjust control at a time. If a parameter is already assigned, it’s grayed out.

3. Select a parameter from the menu.

The parameter is now assigned to the control. To close the list without making any changes, press a location in the display outside the popup window, or press the EXIT switch.

Restoring settings you’ve edited

Using COMPARE

When you’re in the process of editing a sound, pressing the COMPARE switch will recall the last saved version of the sound, as it was before you started editing.

For details, please see “Compare function” on page 18.

Resetting individual controls

You can use the RESET CONTROLS switch to restore the settings or default values that are saved in the knobs.

For details, please see “Resetting the controller settings” on page 21.

Saving your edits

After you've edited a program, you must save it if you want to keep the changes you've made. If you re-select the program or turn off the power after editing, your edits will be lost.

For details, please see "Writing a Program or Combination" on page 88.

You can also save programs on an SD card as PCG files. For details, please see "Saving to media (Media-Save)" on page 91.

Detailed Editing with Programs

Creating your own Programs

You can create original sounds by editing a preloaded program or by editing an initialized program. The programs you create can be saved in banks A–E. For details, please see “Saving your edits” on page 33.

About the edit pages

In the Prog P0: Play page you can select and play programs. Here, you can also use the control surface’s knobs and the tone adjust function to perform quick editing, or edit the settings of the arpeggiator or drum track. In the other pages described here, you can edit the sound in greater detail.

For details on each mode and how to access each page, please see “Basic operations” on page 16.

Basic oscillator settings

Program type setting (single, double, drum kit)

Here, You can specify the type of program (whether to use one oscillator, two oscillators, or a drum kit). Use the Prog P1: Basic/Ctrls– Program Basic **Oscillator Mode** to specify the program type.

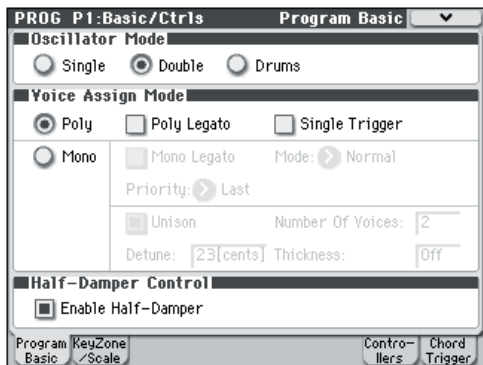

Single Programs have one oscillator, and **Double** Programs have two oscillators. Each oscillator is a multisample that is switched by a crossfade velocity

switch. You can use dual filters, EG, and LFO to create the sound.

Drums mode is a special variation of Single mode, and uses a Drum Kit (as created in Global mode) instead of Multisamples.

Polyphony

Polyphony is the number of notes that can be played simultaneously, such as in a chord. The polyphony depends on the program type.

Program type	Polyphony
Single	80
Double	40
Drums	80

Note:

- Double Programs use twice as many voices as Single Programs.
- Stereo Multisamples use twice as many voices as Mono Multisamples.
- If using velocity crossfade switching, the multisample will use twice as many voices as usual.

Polyphonic/monophonic playing

The Voice Assign Mode selects whether the Program will play polyphonically (**Poly**) or monophonically (**Mono**).

When this is set to **Poly**, you can play both chords and melody lines. When this is set to **Mono**, only one note will sound even if you play a chord.

Normally you’ll set this to **Poly**, but **Mono** is useful when playing sounds such as synth basses, synth leads, and other solo instruments.

Try switching between Poly and Mono, and listen to the results.

Working with Multisamples

What is a multisample?

A sample is a digital recording of a particular instrument or waveform (or other natural or artificially

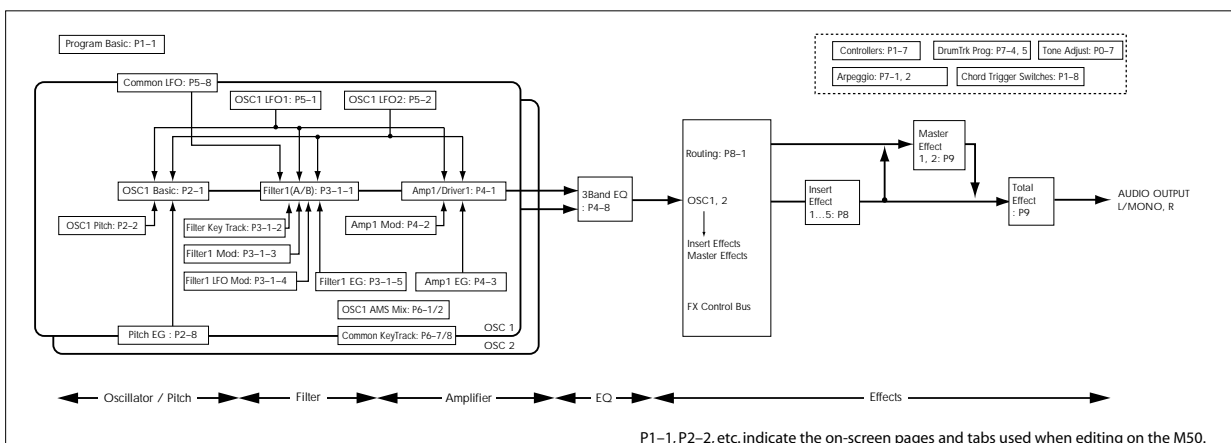

P1-1, P2-2, etc. indicate the on-screen pages and tabs used when editing on the M50.

processed sound) recorded at a specific pitch. A multisample is a collection of similarly voiced samples, used to create the same type of sound - piano, bass, guitar, strings, organ - across the entire keyboard, as the basis of a program. The oscillators of single and double programs use multisamples. There are 1,077 multisamples available in this instrument.

You can assign up to four multisamples to each oscillator and switch between them by velocity.

Multisamples and Drum Kits

Multisamples and Drum Kits allow you to play samples in different ways.

- Multisamples lay out one or more samples across the keyboard. If we use the example of a simple guitar multisample, one sample could be assigned for each string, so that the multisample would consist of six samples.
- As the name suggests, Drum Kits are optimized for playing drumsamples.

Velocity splits, crossfades, and layers

As mentioned above, unless you're in Drum mode, each Oscillator has four velocity zones, named MS1 (High) through MS4 (Low). This means that the Program can play different Multisamples, depending on how hard you play.

Each of these zones has separate settings for Level, Start Offset, and so on. Also, each of the zones can fade into the next, to create smooth velocity transitions. Zones can even be layered together, two at a time.

Selecting Multisamples

Let's create a simple velocity crossfade between two Multisamples, using just OSC1.

1. Access the Prog P2: OSC/Pitch- OSC1 Basic page.
2. Set the Multisample On/Off for MS1 and MS2 to On (checked).

Set the **Multisample On/Off** for MS3 and MS4 to Off (unchecked).

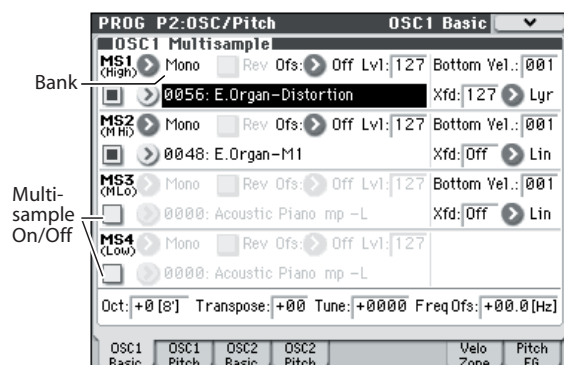

3. Select Stereo as the Multisample Bank for MS1 and MS2.

There are two main types of Multisample Banks: **Mono**, and **Stereo**. Note that stereo Multisamples will require twice as many voices as mono Multisamples.

Multisamples are organized by category such as piano, guitar, bell, etc.

4. Press the Multisample popup for MS1.

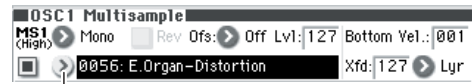

Multisample popup button

This brings up a list of Multisamples, organized by category. Use the tabs at the left of the display to browse through the different categories.

5. Select a Multisample by touching its name in the list.
6. Press the OK button to confirm your selection.
7. Perform the same steps for MS2, selecting a different Multisample than for MS1.

Now that you've assigned Multisamples to MS1 and MS2, let's set up the velocity ranges and crossfades.

Set MS2's **Bottom Vel.** to 001, and its Xfade Range to 0.

8. Set MS1's Bottom Vel. to 80.

Now, MS2 will sound when you play softly, at velocities of 79 or less—and MS1 will sound when you play harder, with velocities of 80 or more.

Next, set MS1's Xfade Range to 20, and its Curve to Linear.

9. You can view this split graphically in the Prog P2: OSC/Pitch- Velocity Zone page.

Notice that the graphic now shows the two ranges tapering into one another. Between 80 and 100, MS2 will fade out, and MS1 will fade in, creating a gradual velocity transition instead of a hard split.

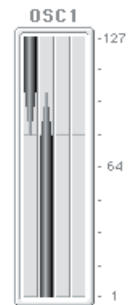

10. As necessary, adjust the "Level" of the two multisamples in the Prog P2: OSC/Pitch- OSC1 Basic page.

Assigning a drum kit

What is a drum kit?

Drum kits are created or edited in Global mode. To each note of the keyboard, you can assign up to four drum instrument samples, and use layering, crossfading, or velocity switching to switch between them. Then, in Program mode, you can make filter and amp settings, and specify effects and routing to the audio output jacks. For details, please see "Editing Drum Kits" on page 239 of the Parameter Guide.

To use a drum kit in a Program, set **Oscillator Mode** to Drums, and choose one of the 144 user drum kits or the nine GM2 drum kits.

Selecting a drum kit

1. Access the Prog P1: Basic/Ctrls- Program Basic page.
2. Set "Oscillator Mode" to Drums.



3. Select a drum kit in the Prog P2: OSC/Pitch– OSC1 Basic page.



4. Specify the basic pitch of the oscillator. For a drum kit, set “Octave” to +0 [8’].

Using LFOs and Envelopes (EGs)

Using LFOs

Each Oscillator has two LFOs: LFO1 and LFO2. There is also a single Common LFO, shared by both Oscillators. While LFO1 and LFO2 are separate for each voice, the Common LFO is shared by all voices in the Program. This makes it useful when you want all of the voices to have an identical LFO effect.

You can use these LFOs to modulate many different Program parameters, including:

- Pitch (for vibrato)
- Filters (for wah effects)
- Volume (for tremolo)
- Pan (for auto-panning)

The LFOs can modulate many other parameters, in addition to those listed above.

Using the basic LFO

1. Access the Prog P5: LFO– OSC1 LFO1 page.

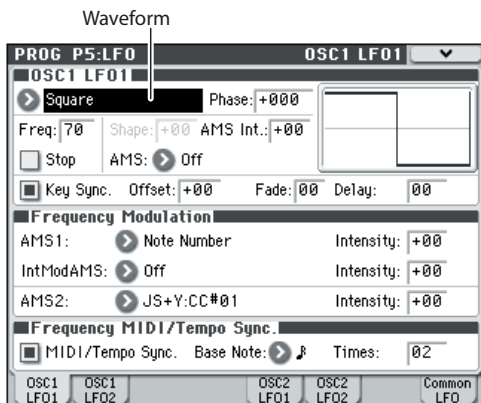

2. Select the Waveform parameter.

Use the Inc Δ and Dec ∇ switches to scroll through the different waveforms, and look at their shapes in the graphic display.

There are a number of waveforms to choose from. Each are suited to different applications:

Triangle and **Sine** are the classic LFO shapes for vibrato, tremolo, panning, and filter wah effects.

Square is useful for gated on and off filter and amp effects, and can create trills when modulating pitch.

The **Guitar** waveform is designed especially for guitar vibrato; it bends only upwards from the base value.

Saw and **Exponential Saw Down** are good for rhythmic filter and amp effects.

Random 1 (S/H) creates the classic sample-and-hold effect, which is great for modulating a resonant filter.

3. After looking at the different waveforms, select Triangle.

4. Select the Shape parameter, and use the VALUE slider to move through its different settings, from -99 to +99.

Notice how the shape of the waveform becomes more curved, and how -99 emphasizes the lower part of the shape, and +99 emphasizes the upper part.

5. Select the Phase parameter, and use the VALUE slider to sweep through its range of values.

Notice how the waveform shifts from side to side. Among other things, this lets you offset the LFOs from one another in time, which can create interesting organic effects.

6. Use the Freq (Frequency) parameter to set the speed of the LFO.

7. Use the Fade and Delay settings to control the way the LFO sounds at the beginning of the note.

For more information on LFOs, please see “PROG P5: LFO” on page 48 of the Parameter Guide.

All of these parameters control the way that the LFO works. In order for the LFO to actually affect the sound, you can use the dedicated LFO routings on the Filter, Pitch, and Amp pages, or use the LFOs as AMS sources for a wide variety of parameters.

EGs (Envelope Generators)

An envelope creates a modulation signal by moving from one level to another over a specified time, and then moving to another level over another period of time, and so on.

The Program includes three EGs, for Pitch, Filter, and Amp. These produce time-varying changes in pitch, tone, and volume respectively. They can also be used to modulate a number of other program parameters via AMS.

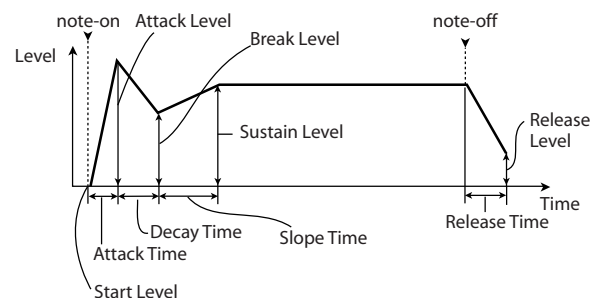

Using Alternate Modulation (AMS) and the AMS Mixers

Alternate Modulation

AMS (Alternate Modulation Source) refers to any of the assignable modulation sources in M50, including:

- Controllers of the M50 itself, such as the joystick, SW 1/2, and the realtime knobs
- Incoming MIDI controllers
- Modulators such as the Filter, Pitch, and Amp EGs, the LFOs, or the AMS Mixers

Intensity is a parameter that sets the degree (speed, depth, amount etc.) to which AMS will control the modulation.

A number of frequently-used modulation routings, such as using the joystick to vary the pitch, are provided as additional, dedicated routings, separate from AMS.

Note that not all AMS sources may be available for some modulation destinations.

For details on alternate modulation and AMS, please see below.

- “Alternate Modulation Sources (AMS)” on page 373 of the Parameter Guide
- “Creating Vibrato” on page 37
- “Pitch EG” on page 38
- “Filter EG” on page 39
- “LFO modulation” on page 39
- “AMS (Pan)” on page 42 of the Parameter Guide
- “LFO1/2” on page 41

Using the AMS Mixers

The AMS Mixers combine two AMS sources into one, or process an AMS source to make it into something new.

For instance, they can add two AMS sources together, or use one AMS source to scale the amount of another. You can also use them to change the shapes of LFOs and EGs in various ways, modify the response of realtime controllers, and more.

The AMS Mixer outputs appear in the list of AMS sources, just like the LFOs and EGs.

This also means that the original, unmodified inputs to the AMS Mixers are still available as well. For instance, if you use LFO 1 as an input to an AMS Mixer, you can use the processed version of the LFO to control one AMS destination, and the original version to control another.

Finally, you can cascade the two AMS Mixers together, by using AMS Mixer 1 as an input to AMS Mixer 2.

For details, please see “6-1: OSC1 AMS Mix1” on page 52 of the Parameter Guide.

Tips for using AMS

When making settings for alternate modulation, think of the effect that you wish to produce, what type of modulation will be necessary to produce that effect, and what parameter of the oscillator, filter, or amplifier needs to be controlled.

Next, select a source (AMS) and set the **Intensity**. If you proceed logically in this way, you will achieve the desired effect.

For example in a guitar sound program where you want to use the joystick to control the feedback, you would make assignments so that the joystick controls the filter frequency and resonance.

Controller Setup page

For each program, the function of Realtime Control knobs 1-B-4-B and the SW1 and SW2 switches can be assigned in the Prog P1: Basic/Ctrls- Controllers Setup page.

For details, please see “Setting the functions of SW1 and SW2” on page 18 of the Parameter Guide, and “Setting the functions of Realtime Control B mode knobs 1-4” on page 19 of the Parameter Guide.

Controlling Pitch

Pitch bend

The **JS (+X)** and **JS (-X)** settings specify the amount of pitch change (in semitones) that will occur when MIDI pitch bend messages are received or when the joystick is moved to left or right. A setting of **+12** allows the pitch to be controlled a maximum of one octave upward; a setting of **-12** allows the pitch to be controlled a maximum of one octave downward.

Ribbon (#16) specifies the amount of pitch change (in semitone units) that will occur when MIDI control change message #16 is received. With a setting of **+12**, a value of 127 will raise the pitch one octave, and a value of 0 will lower the pitch one octave.

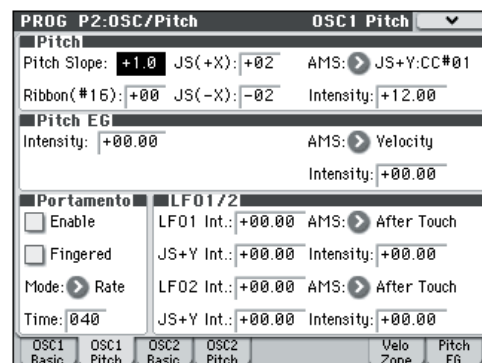

Creating Vibrato

You can use an LFO to create vibrato.

LFO1 Int. or **LFO2 Int.** sets the depth to which the selected LFO will affect the pitch. With a setting of **+12.00**, vibrato will produce a maximum of ± 1 octave of pitch change.

JS+Y Int specifies the amount of vibrato that the LFO will produce when the joystick is pushed away from you.

Intensity (AMS Intensity) specifies the depth of vibrato that will be applied by the LFO when modulated by the selected AMS (Alternate Modulation Source). For example, if the panel switch assignment for **SW1** is set to SW1 Mod. (CC#80) (Prog 1-7a), and you set **LFO1 AMS** to SW1: CC#80 and specify an appropriate value for **Intensity**, vibrato will be applied when you turn SW1 on or when MIDI control change #80 is received.

Pitch EG

When the **Intensity** value is set to +12.00, the pitch EG specified in the Pitch EG page will produce a maximum of ±1 octave of pitch change.

To realistically simulate the slight change in pitch that occurs when a string is plucked or at the attack of a brass or vocal sound, you can use the EG to create a subtle change in pitch at the attack.

Portamento

Portamento makes the pitch change smoothly when you play the next note before releasing the previous note.

The **Time** parameter controls how long it take the pitch to change. As this value is increased, the pitch will change over a longer time. With a value of 000, there will be no portamento.

You can turn Portamento on and off via SW1 or SW2, by assigning them to **Porta.SW CC#65**.

Using Filters

The filters allow you to diminish or emphasize specified frequency areas of the sound.

The tone of the sound will depend significantly on the filter settings.

The basic filter settings, including the routing, type, cutoff frequency, and resonance, are set on the P3-1: Filter1 or P3-2: Filter2 page.

Filter Routing

Each oscillator has two filters, Filter A and Filter B. The **Filter Routing** parameter controls whether one or both of the filters are used, and if both are used, it controls how they are connected to each other.

The **Single** routing uses only Filter A as a single 2-pole, 12dB/octave filter (6dB for Band Pass and Band Reject).

The **Serial** routing uses both Filter A and Filter B. The oscillator first goes through Filter A, and then the output of Filter A is processed through Filter B.

Parallel also uses both Filter A and Filter B. The oscillator feeds both filters directly (and allow independent settings for each), and the outputs of the two filters are then summed together.

The **24dB(4Pole)** routing merges both filters to create a single 4-pole, 24dB/octave filter (12dB for Band Pass

and Band Reject). In comparison to Single, this option produces a sharper roll-off of frequencies beyond the cutoff frequency, as well as a slightly more delicate resonance. Many classic analog synths used this type of filter.

Serial and Parallel Routing

Serial

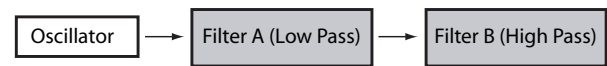

Parallel

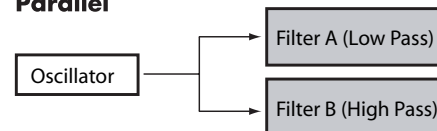

Filter Types

This selects the parts of the sound which will be affected by the filter, as described below. With the Serial and Parallel routings, you can independently set the types for Filter A and Filter B.

The filters will produce very different results depending on the selected filter type.

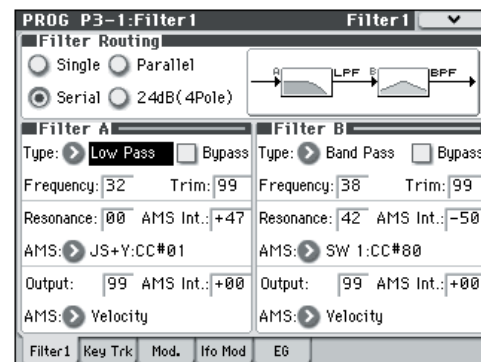

Low Pass: This cuts out the parts of the sound which are **higher** than the cutoff frequency. Low Pass is the most common type of filter, and is used to make bright timbres sound darker.

High Pass: This cuts out the parts of the sound which are **lower** than the cutoff frequency. You can use this to make timbres sound thinner or more buzzy.

Band Pass: This cuts out all parts of the sound, both highs and lows, except for the region around the cutoff frequency. Since this filter cuts out both high and low frequencies, its effect can change dramatically depending on the cutoff setting and the oscillator's multisample.

With low resonance settings, you can use the Band Pass filter to create telephone or vintage phonograph sounds. With higher resonance settings, it can create buzzy or nasal timbres.

Band Reject: This filter type—also called a notch filter—cuts only the parts of the sound directly around the cutoff frequency. Try modulating the cutoff with an LFO to create phaser-like effects.

Filter Types and Cutoff Frequency

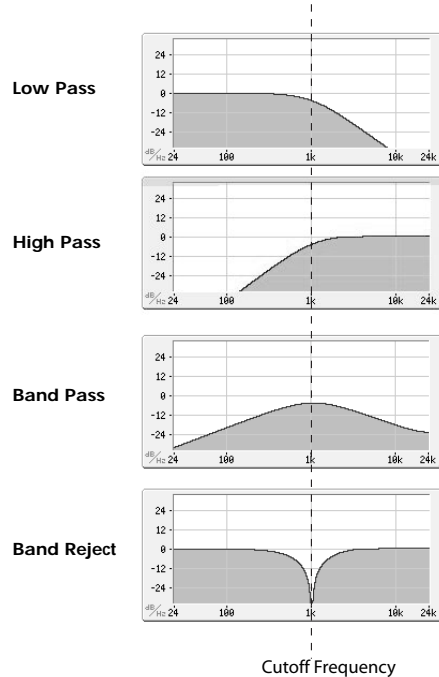

Resonance

Resonance emphasizes the frequencies around the cutoff frequency, as shown in the diagram below.

When this is set to 0, there is no emphasis, and frequencies beyond the cutoff will simply diminish smoothly.

At medium settings, the resonance will alter the timbre of the filter, making it sound more nasal, or more extreme. At very high settings, the resonance can be heard as a separate, whistling pitch.

To make the resonance track the keyboard pitch, please see “Key Follow,” on page 33 of the Parameter Guide.

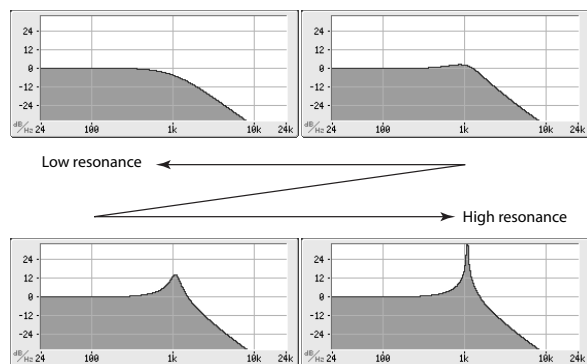

Modulating the filters

You can modulate the filter cutoff frequency using the Filter EG, the LFOs, keyboard tracking, and other built-in and MIDI controllers. This is a great way to add a rich variety of tonal change to the sound.

Filter EG

The Filter EG is a multi-stage envelope, which you can use to modulate the filter (naturally!) as well as other Program parameters. The EG itself is set up on the EG tab; the way that it affects the filters is controlled by the

parameters described below, on the Filter1/2-Modulation page:

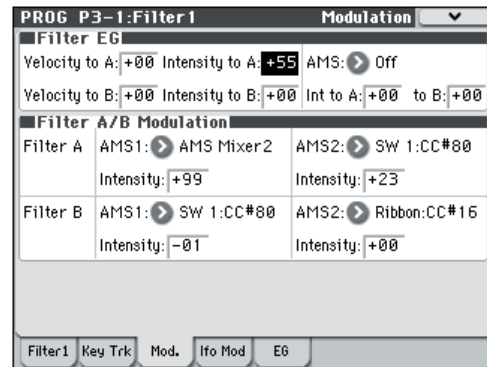

The **Intensity to A** and **Intensity to B** settings control the basic amount of EG modulation for filter frequencies A and B, respectively, before other modulation.

The **Velocity to A** and **Velocity to B** settings let you use velocity to control the amount of EG modulation.

The **AMS** setting selects an AMS modulation source to scale the amount of the Filter EG applied to Filters A and B. The two filters share a single AMS source, with separate intensity **Into A** or **to B** settings.

LFO modulation

You can modulate the filter via LFO1, LFO2, and the Common LFO. Among other applications, LFO modulation of the filter can produce the classic “auto-wah” effect.

The Filter1/2- LFO Mod. page lets you set up the following parameters separately for each LFO:

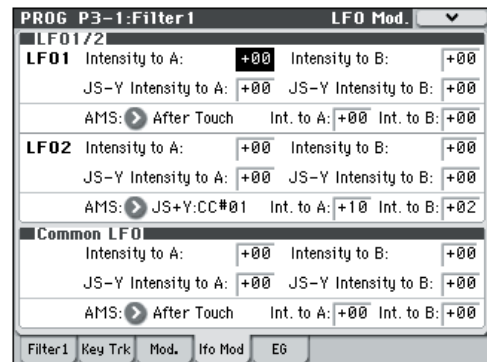

Intensity to A and **Intensity to B** specify how much the LFO changes the tone.

JS-Y Intensity to A and **JS-Y Intensity to B** specify the depth of the wah effect produced by the LFO when the joystick is moved toward yourself, or when CC#2 is received.

The **AMS** setting selects an AMS modulation source to scale the amount of the LFO applied to Filters A and B. The two filters share a single AMS source, with separate intensity settings.

For example if **AMS** is set to SW1: CC#80, turning SW1 on will apply an auto-wah effect.

Keyboard Track

Most acoustic instruments get brighter as you play higher pitches. At its most basic application, keyboard tracking re-creates this effect by increasing the cutoff frequency of a lowpass filter as you play higher on the keyboard. Usually, some amount of key tracking is necessary in order to make the timbre consistent across the entire range.

The M50 keyboard tracking can also be much more complex, since it allows you to create different rates of change over up to four different parts of the keyboard. For instance, you can:

- Make the filter cutoff frequency increase very quickly over the middle of the keyboard, and then open more slowly—or not at all—in the higher octaves.
- Make the cutoff frequency increase as you play lower on the keyboard.
- Create abrupt changes at certain keys, for split-like effects.

How Key Track works: Keys and Ramps

The keyboard tracking works by creating four ramps, or slopes, between five keys on the keyboard.

For details, please see “How it works: Keys and Ramps,” on page 32 of the Parameter Guide.

Using the Amp section

The Amp section includes controls for volume, pan, and the driver circuit.

You can control the volume using the Amp EG, LFO 1/2, Key Track, and velocity, along with other AMS sources.

Each Oscillator has its own Amp section: Amp1 for OSC1, and Amp2 for OSC2.

Background - what does “Amp” mean?

Different sounds have characteristic shapes to their volume levels.

For example, the volume of a piano note begins at a high volume the instant you play the note, and then decreases gradually.

The volume of an organ note, on the other hand, remains constant as long as you continue pressing the key.

The volume of a note on a violin or wind instrument can be varied during the note by the musician (i.e., by regulating the amount of pressure on the bow or the force of the breath).

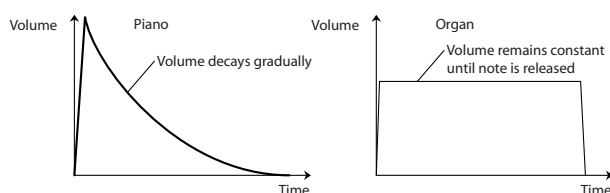

Pan

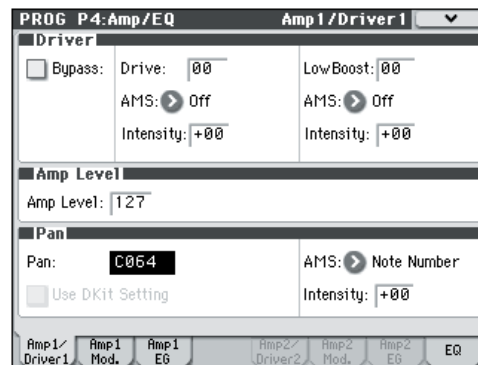

Pan

The main **Pan** parameter controls the stereo position after the signal has passed through the oscillator, filter, and amp.

Normally you'll set this to **C064**, so that the sound is centered equally between the left and right speakers.

To create a stereo effect when **Oscillator Mode** is set to **Double**, set the Amp1/Driver 1 page **Pan** to L001, and the Amp2/Driver2 page **Pan** R127. This will make OSC1 go to the left speaker, and OSC2 go to the right speaker.

With a setting of **Random**, the pan will change randomly each time you play a note on M50, producing an interesting effect.

Pan - Use DKit Setting

Use DKit Setting applies when **Oscillator Mode** is set to **Drums**.

If this is **checked**, the Program can use a different pan position for each drum sound, as specified by the Drum Kit. If this is **unchecked**, all drum sounds will use the Program's pan position.

The factory presets and GM drum kits use individual pan positions for the different drums, so normally it's best to leave this checked.

Amp modulation

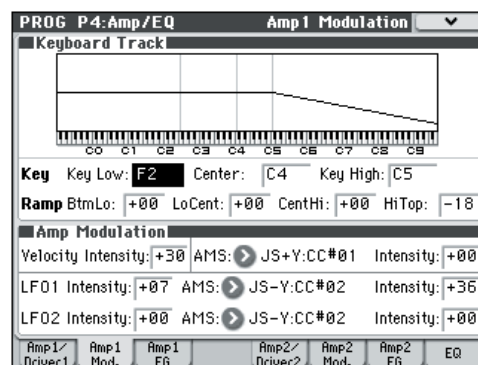

The basic volume level is set by the **Amp Level** parameter. You can then alter this using the modulation sources below:

Keyboard Track

This lets you vary the volume relative to the note you play.

For details, please see “Keyboard Track” on page 40.

Amp Modulation

Velocity Intensity is used by most programs to decrease the volume of softly played notes and increase the volume of strongly played notes, and the Amp Modulation parameter adjusts the depth of this control.

Normally you will set Amp Modulation to positive (+) values. As this setting is increased, there will be greater volume difference between softly played and strongly played notes.

LFO1/2

Specifies how the LFO's will produce cyclic changes in volume (tremolo effect).

The volume will be affected by the LFO(s) for which you set an **LFO1 Intensity**, **LFO2 Intensity** value.

Intensity (AMS Intensity) adjusts the depth by which the tremolo effect produced by the LFO will be affected when you assign an AMS (LFO1 AMS, LFO2 AMS).

For example, if you set AMS to **JS-Y: CC #02**, tremolo will be applied when you push the M50's joystick down (toward yourself), or when CC#02 is received.

Amp EG

The Amp EG lets you control how the volume changes over the course of a note.

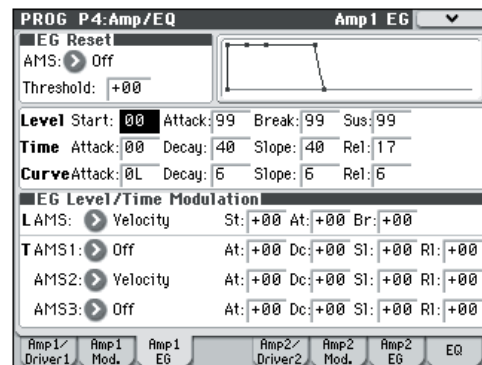

Every instrument has its own characteristic volume envelope. This is part of what gives each instrument its identifiable character.

Conversely, by changing the volume contour—for instance, applying a string-like Amp EG curve to an organ multisample—you can produce interesting and unusual sounds.

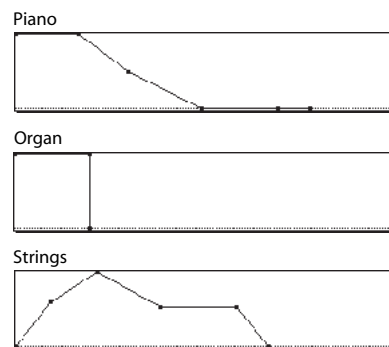

Drive

The Drive circuit adds saturation and overdrive to the sound, for everything from subtle fattening to drastic distortion. Unlike an overdrive effect, Drive processes each voice individually, so the timbre stays the same regardless of how many voices are being played.

The two main parameters, **Drive** and **Low Boost**, work together to create the overall effect.

Drive controls the amount of edge and bite in the timbre. Low settings will produce mild saturation, and higher settings create more obvious distortion.

Often, it's useful to increase the **Low Boost** along with the **Drive**.

Note: even when the **Drive** amount is set to 0, the **Drive** circuit still affects the timbre. If your goal is a completely pristine sound, use the **Bypass** control instead.

Low Boost is a special low-frequency EQ which controls the body character of the sound. The specific EQ frequencies affected will change with the **Drive** setting.

Higher amounts increase the bass boost, and will also intensify the effect of the **Drive** parameter.

Arpeggiator settings

According to the note data received from the keyboard or from the MIDI IN connector, the arpeggiator will automatically generate a wide range of phrases or patterns including arpeggios, guitar or keyboard backing riffs, bass phrases, or drum patterns. When the control surface ARP is selected, you can use the knobs to vary the duration and dynamics of the arpeggiated notes.

For more about the arpeggiator, please see page 73.

Drum Track settings

You can use the M50's rich variety of drum patterns to accompany you with high-quality drum programs while you perform using a program.

Playing along with Drum Track patterns is often a useful way to come up with new phrases.

For more about the Drum Track function, please see page 79.

Effects

For details, please see "Using Effects" on page 67.

Automatically importing a Program into Sequence mode

The Auto Song Setup feature copies the current Program into a Song, and then puts the M50 in record-ready mode.

For details, please see "Tip: Auto Song Setup" on page 126 of the Parameter Guide.

Playing and editing Combinations

About the M50's combinations

Combinations let you split and layer up to 16 Programs at once.

A Combination is made up of 16 Timbres (Note that you don't have to use all 16 Timbres!). Each Timbre is assigned a Program, along with parameters for key range and velocity zones, mixer settings, MIDI channel and controller filtering, and so on.

As with Programs, each Combination has five insert effects, two master effects, and one total effect for shaping and transforming the sounds of the individual Timbres.

This section of the manual takes a quick look at playing Combinations, including tours of the front-panel controllers and basic editing techniques.

Playing combinations

Selecting Combinations

There are several different ways to select Combinations. Each one is convenient in a different way:

- Using "Combination Select" and the VALUE controllers:
- Using the Bank/Combination Select menu:
- Using the Category/Program Select menu:
- Using a foot-switch: PG page 228
- Sending MIDI program change messages to select Programs remotely: PG page 95, page 218, page 220 and page 392

Selecting a program using "Combination Select" and the VALUE controllers

1. Press the MODE COMBI switch. (The LED will light.) (Refer to the illustration below for the switches.)

The M50 will enter Combination mode.

2. Access the Combi P0: Play- Program T01-08 page. This is shown in the top line of the display.

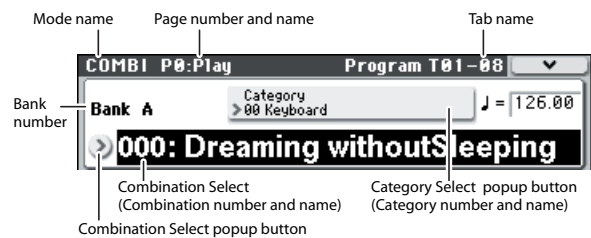

If a different page is shown, press the EXIT switch several times to move to the Combi P0: Play- Program T01-08 page.

3. Make sure that "Combination Select" is selected. If it is not, press "Combination Select" in the display to highlight it.

4. Select the combination you want to play.

You can use the following methods to select a combination.

- Use the Δ or ∇ switches.

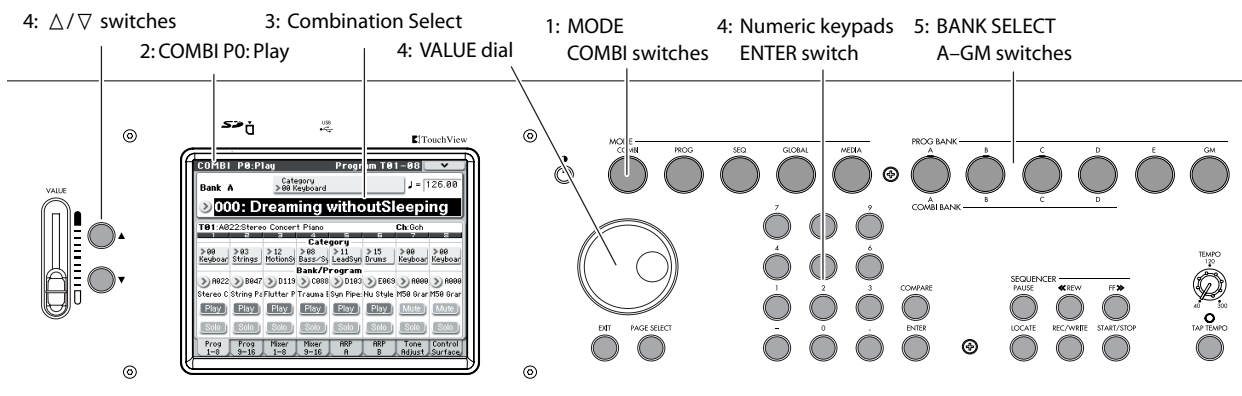

- Turn the VALUE dial.
 - Use numeric keys 0–9 to enter the combination number, and press the ENTER switch.
5. Press a COMBI BANK A–D switch to switch banks.

When you select a different Bank, the switch’s LED will light, and the selected bank will appear on the left side of the display.

For example, to select bank B, press the COMBI BANK B switch. The B switch will light, and the name Bank B will appear in the left side of the display.

Auditioning the sound

Play the M50’s keyboard to hear the combination you’ve selected. You can also audition the combination by pressing the chord trigger switches.

Overview: Combination Banks

With the factory settings, the M50 contains 384 preloaded combinations that are GM2 compatible. In addition to these, there are 128 combinations to store sounds that you create, or store optional sound libraries.

Combinations are organized into four banks as shown in the following table.

Combination bank contents

Bank	Combi. No.	Explanation
A...C	000...127	Factory Programs.
D	000...127	Initialized Programs.

Selecting by Bank/Combination Select menu

You can select Combinations from a list organized by Combination bank.

- Press the Combination Select popup button to access the menu and make your selection.

The selection method is the same as in “Selecting by Bank/Program Select menu” on page 28; Refer to that page for details.

Bank/Combination Select menu



Selecting by Category/Combination Select menu

You can select Combinations arranged by category, such as keyboard, organ, bass, and drums.

When shipped from the factory, the preloaded Combinations are organized into 16 categories, each with several sub-categories.

- Press the Category Select popup button to access the menu and make your selection.

The selection method is the same as in “Selecting by Category/Program Select menu” on page 29; refer to that page for details.

Category/Combination Select menu



Performing with the arpeggiator or drum track

Based on note data it receives from the keyboard or from the MIDI IN connector, the arpeggiator can generate a wide range of phrases and patterns including arpeggios, guitar or keyboard backing riffs, bass phrases, or drum patterns. When the control surface ARP is selected, you can use the knobs to vary the duration and dynamics of the arpeggiated notes.

For more about the arpeggiator, please see page 73.

The Drum Track function uses a rich variety of drum patterns to play the M50’s high-quality drum programs. You can perform along with the drum patterns, or synchronize Drum Track patterns with the phrases generated by arpeggiator.

For more about the Drum Track function, please see page 79.

Using controllers to modify the sound

The M50 provides a variety of controllers that you can use to vary the sound, such as the joystick, the SW1, SW2 switches, and the control surface knobs. It also provides chord trigger switches.

For details, please see the corresponding explanation for Programs: “Using Controllers” on page 29.

Easy Combination editing

You can edit any of the Combinations shipped with M50. You can create your own combinations by editing a preloaded combination, or by starting from an initialized combination.

Even without moving to the various pages for detailed editing, you can make dramatic changes just from within the Combi P0: Play page. You can also edit using the control surface's knobs on the front panel.

Changing the program assigned to a timbre

Changing the Programs assigned to timbres (1–16) is a quick way to dramatically alter the sound of the Combination.

Changing the program of each timbre

1. Access the Combi P0: Play– Program T01–08/T09–16 page.

In this page you can view the program assigned to each timbre 1–16, and the play/mute and solo status of each.

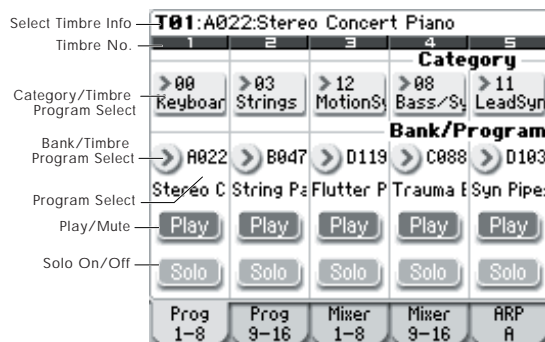

2. Use any of the following methods to select a Program for each timbre.
 - Choose **Program Select**, use numeric keys 0–9 to input the program number, and press the ENTER switch.
 - Choose **Program Select** and turn the VALUE dial, VALUE slider or use the Δ/∇ switches.
 - If the **Program Select** parameter is selected, the PROG BANK A–GM switches will switch program banks. (If Timbre Program Select is selected, the BANK switch LED of the program bank selected for that timbre will light.)
 - From the Bank/Program Select menu you can view and select programs by bank.
 - From the Category/Program Select menu you can view and select programs by category.
 - You can transmit MIDI program changes from a connected external MIDI device. (See PG page 393)

Note: To select the timbre program via MIDI program change the timbre's status must be set to "INT."

Adjusting the mix

Adjusting the volume of each timbre

1. Access the Combi P0: Play– Mixer T01–08 page.

This page shows the volume, pan, and Program assignments for all 8 Timbres.



2. Select the on-display Volume slider for Timbre 1. Use Δ/∇ , the VALUE slider, or the numeric keypad to set the volume as desired.

If you check **Hold Balance**, moving any one of the volume sliders (volume values) will cause the volume of the other timbres to change as well, maintaining the relative volume balance between timbres 1–16. This is a convenient way to adjust the overall volume.

Adjusting the pan of each timbre

1. Access the Combi P0: Play– Mixer T01–08 page.
2. Select the on-screen Pan knob for Timbre 1, and edit its value as desired.

Timbre pan interacts with the pan stored in the Program. A setting of C064 reproduces the Program's oscillator pan settings. Adjusting the Timbre Pan will move the sound to left or right while preserving the pan relationship between the oscillators. A setting of L001 is far left, and R127 is far right.

Simple editing using the knobs

You can use the Control Surface to perform a variety of edits.

For example, you can use the control surface to adjust the Filter cutoff or resonance. You can also use it to vary the depth of an effect, or to change the way in which the arpeggiator generates a phrase.

For details, please see "Control Surface knobs" on page 20.

Saving a Combination you've edited

After you've edited a combination, you must save it if you want to keep the changes you've made. If you re-select the combination or turn off the power before saving, your edits will be lost.

For details, please see "Writing a Program or Combination" on page 88.

You can also save combinations on an SD card as PCG files.

For details, please see "Saving to media (Media-Save)" on page 91.

Detailed Editing with Combinations

You can edit the preloaded combinations (Banks A–C) with which the M50 is shipped, or start with an initialized Combination to create your own original sounds.

You can use the factory Programs to create new Combinations, or use your own custom Programs.

Note: If you're in the process of editing a Program in Program mode, and you use that Program in a Combination, you'll hear the edited version in Combination mode as well.

About the edit pages

In the Combi P0: Play page you can select and play combinations. Here you can also use the control surface's knobs and the tone-adjust function for quick editing, or to edit the settings of the arpeggiator or drum track. In the other pages you can edit the sound in greater detail.

For details on each mode and how to access each page, please see "Basic operations" on page 16.

A suggested approach for editing

First, select a Program for each Timbre, on the P0: Play– Program T01–08 or T09–16 page. (Note that you don't have to use all 16 Timbres!)

Next, create any desired keyboard or velocity splits, layers, or crossfades between the different Timbres. You can do this on the P4: Zone/Delay– Keyboard Zones page.

After this, adjust the volumes of the Timbres (back on the Program Select/Mixer tab), and set up any other Timbre parameters as desired.

To add finishing touches to the sound, set up the Insert, Master, and Total Effect as desired (on the P8: IFX and P9: MFX/TFX pages, respectively.) These effects can be different from those associated with the individual Programs in Program mode, if desired.

In addition, you can make arpeggiator and drum track settings (on the P7: ART/DT page) and controller settings (on the P1: Controllers page) to create the finished Combination.

Soloing timbres

You can use the Control Surface's Solo function to hear the sound of each timbre by itself.

For details, please see "Solo On/Off" on page 82 of the Parameter Guide.

Restoring edited settings

Using COMPARE

When you're in the process of editing a sound, pressing the COMPARE switch will recall the saved version of the sound, as it was before you started editing.

For details, please see "Compare function" on page 18.

Resetting individual controls

You can use the RESET CONTROLS switch to restore the settings or default values that are saved in the knobs.

For details, please see "Resetting the controller settings" on page 21.

Combination structure and corresponding pages

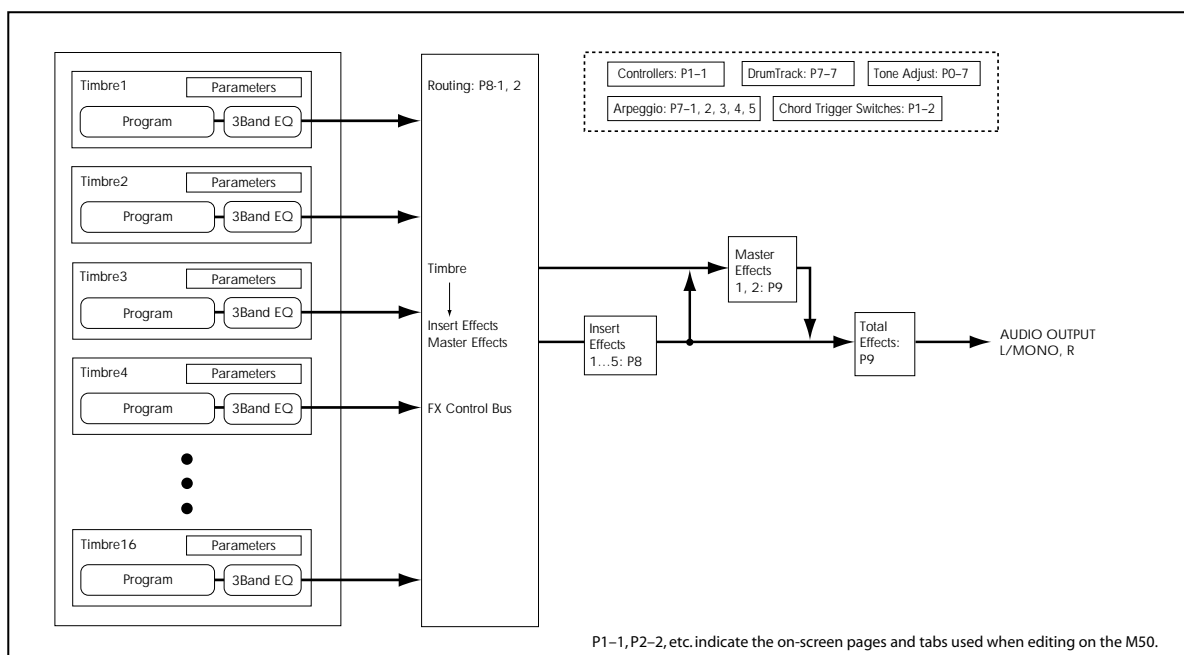

Layers, Splits, and Velocity Switches

Within a Combination, you can use note range and velocity level to define the “zone” in which a specific timbre will play.

The Programs assigned to each Timbre can be played in three ways: as part of a **layer**, a **split**, or a **velocity switch**. A Combination can be set to use any one of these methods or to use two or more of these methods simultaneously.

Layer

Layers cause two or more Programs to play simultaneously when a note is played.

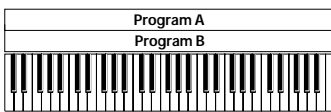

Layer:
Two or more programs sound simultaneously.

Split

Splits cause different Programs to respond on different areas of the keyboard.

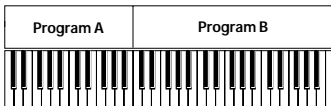

Split:
Different programs will sound in different areas of the keyboard.

Velocity Switch

Velocity Switches cause different Programs to respond depending on the velocity (how hard you play the notes).

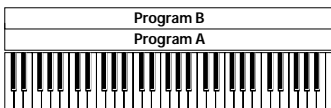

Strong ↑ Keyboard playing dynamics
Soft

Velocity Switch:
Keyboard playing dynamics (velocity) switches between different programs.

On the M50, you can use a different Program for each of up to sixteen Timbres, and combine two or more of the above methods to create even more complex setups.

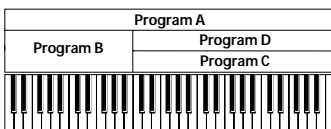

Strong ↑ Keyboard playing dynamics
Soft

Example:
B and C/D are split. In the lower keyboard range, A and B are layered. In the higher keyboard range, C and D are switched by velocity and layered with A.

As an additional possibility, you can set the slope for a key zone or velocity zone so that the volume diminishes gradually. This lets you change a split into a keyboard crossfade, or a velocity switch into a velocity crossfade.

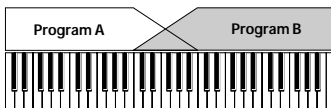

Keyboard X-Fade (keyboard crossfade):
As you play from low notes to high notes, the volume of A will fade out, and the volume of B will fade in.

Creating Key Splits and Layers

Splits and Layers

Let’s create a Combination which combines both splits and layers, like the diagram below:

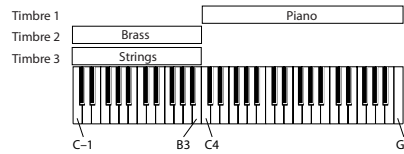

1. Access the Combi P0: Play– Program T01–08 page.
2. Select a piano sound for Timbre 1, a brass sound for Timbre 2, and a strings sound for Timbre 3.
3. Access the P3: Timbre Param– MIDI T01–08 page.
4. For Timbres 1–3, set Status to INT and MIDI Channel to Gch (the Global Channel).

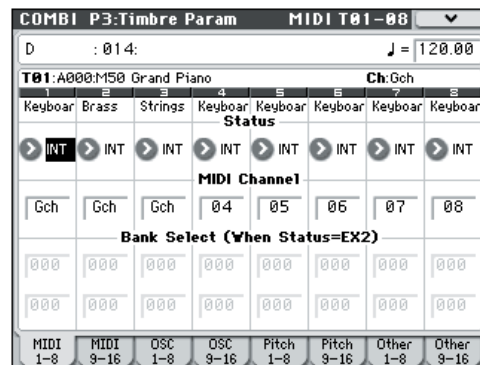

5. Access the P4: Zone/Delay– Key Z T01–08 page.
6. Set Timbre 1’s Top Key to G9, and its Bottom Key to C4.

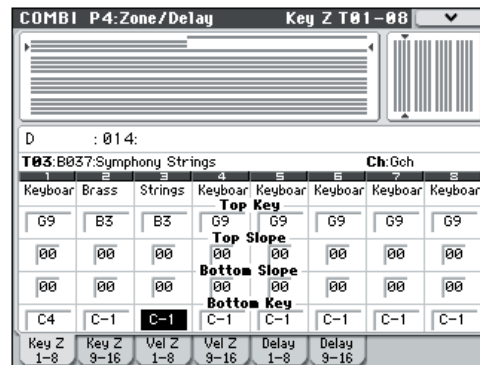

You can also enter a note value by selecting the parameter and then playing the desired note on the keyboard while holding down the ENTER switch.

7. Set Timbres 2 and 3 to a Top Key of B3, and a Bottom Key of C-1.

Key Zone Slope

In addition to “hard” splits, in which the sound changes abruptly, you can use the Slope parameters to gradually fade a sound in or out over a range of keys.

In the example above, you could set the Bottom Key of timbre 1 to G3, and set the Top Key of timbre 2 to G4, so that these two timbres overlap.

Next, if you set the **Bottom Slope** of timbre 1 to 12, and set the **Top Slope** of timbre 2 to 12, the sound will change gradually instead of changing suddenly.

Creating Velocity Switches

Next, let's create a simple velocity switched Combination, like the diagram below:

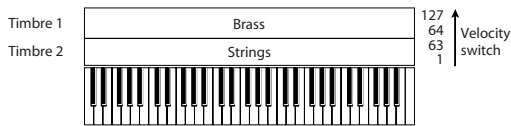

1. Access the Combi P0: Play- Program T01-08 page.
2. Select a brass sound for Timbre 1, and a strings sound for Timbre 2.
3. Access the P3: Timbre Param- MIDI T01-08 page.
4. For Timbres 1 and 2, set Status to INT and MIDI Channel to Gch (the Global Channel).
5. Access the P4: Zone/Delay- Vel Z T01-08 page.
6. Set Timbre 1's Top Velocity to 127, and its Bottom Velocity to 64.

You can also enter a velocity value by selecting the parameter and then playing a note with the desired velocity on the keyboard while holding down the ENTER switch.

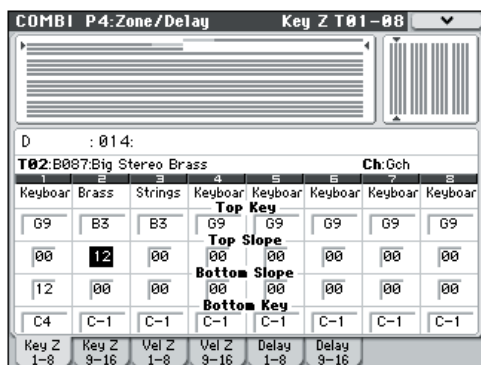

7. Set Timbre 2 to a Top Velocity of 63, and a Bottom Velocity of 1.

Velocity Zone Slope

Similar to Key Zone Slopes, as described above, these let you fade in and fade out sounds gradually over a velocity range, instead of a simple hard switch.

In the case of the above example, you could set the velocity zones of the two Timbres so that they partially overlap. Then, set the Top Slope and Bottom Slope so that the sound changes gradually, instead of changing suddenly between velocity values of 63 and 64.

MIDI settings

Timbre Parameters MIDI page

Status

This controls the status of MIDI and the internal tone generator for each Timbre. Normally, if you're playing an internal Program, this should be set to INT.

If the status is set to Off, EXT, or EX2, that Timbre's internal sounds will not be played. Off simply disables

the Timbre entirely. The EXT and EX2 settings allow the Timbre to control an external MIDI device.

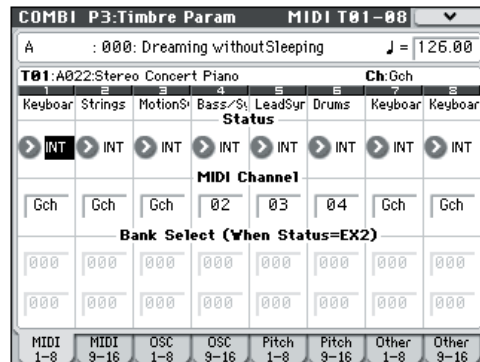

For details, please see "Status" on page 95 of the Parameter Guide.

Bank Select (when status=EX2)

When the Status is set to EX2, these parameters allow you to transmit MIDI Bank Select messages to external MIDI devices.

MIDI Channel

Timbres that you wish to play from the M50's keyboard must be set to the global MIDI channel. Your playing on the keyboard is transmitted on the global MIDI channel, and will trigger any timbre that matches this channel. Normally you will set this to Gch. When this is set to Gch, the MIDI channel of the timbre will always match the global MIDI channel, even if you change the global MIDI channel.

On some preloaded Combinations, Timbres used by the arpeggiator may have their MIDI Channels set to something other than Gch. These will be timbres that play only when the arpeggiator is on- a very useful technique for creating "arpeggiator-used" Combinations.

For details, please see "Arpeggiator settings in Combination and Sequencer modes" on page 109 of the Parameter Guide. In particular, note the relationships between arpeggiator A/B assignments and MIDI Channel.

MIDI filter settings

For each MIDI Filter item, you can specify whether or not the corresponding MIDI message will be transmitted and received. The checked items will be transmitted and received.

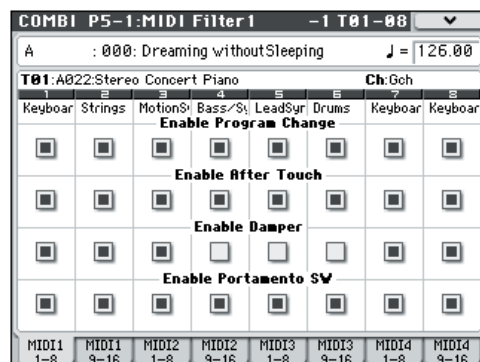

Creating songs (Sequencer mode)

Overview

About the M50's Sequencer

The M50's 16-track MIDI sequencer can hold up to 128 songs and 210,000 MIDI events.

You can record and play back MIDI data using sixteen MIDI tracks and one master track (containing tempo data, etc.) to control the internal sound generator and your external sound modules.

With its broad range of capabilities such as the arpeggiators, high-quality effects, and controllers, the M50 is the ideal environment for music production or live performance.

⚠ When you turn off the power, the settings made in Sequencer mode, the song data, and any user pattern data that you recorded will not be backed up. If you wish to keep this data, you must save it on an SD card before turning off the power, or perform a MIDI data dump to save the data on an external data filer etc.

If you wish to write the programs, track parameters, effects, and arpeggiator settings etc. selected for a song as a template song, use the menu command **Save Template Song**.

Immediately after the power is turned on, M50 will not contain any song data, so if you wish to play a song on the sequencer, you must first load data from SD card, or receive a MIDI data dump from a MIDI filer. For details, please see "Loading data" on page 93, and "Dump Sequencer" on page 253 of the Parameter Guide.

Sequencer mode structure

Sequencer mode is structured as follows.

For details on each mode and how to access each page, please see "Basic operations" on page 16.

Songs

A song consists of MIDI tracks 1–16, a master track, song parameters such as the song name, arpeggiator, Drum Track function, effect and RPPR parameters, and 100 user patterns.

A maximum of 128 such songs can be created on M50.

MIDI tracks 1–16 each consist of setup parameters located at the start location, and musical data within the track. The master track consists of tempo and time signature data.

For details, please see "Setup parameters & Musical data" on page 126 of the Parameter Guide.

Song recording and editing

Song recording is performed on tracks.

You can record MIDI tracks in either of two ways; realtime recording or step recording. For realtime recording you can choose one of six recording modes.

You can edit MIDI tracks by using Event Edit operations to modify the recorded data or insert new data, and by using Track Edit operations such as Create Control Data, which generates and inserts pitch bend, aftertouch, or control change data.

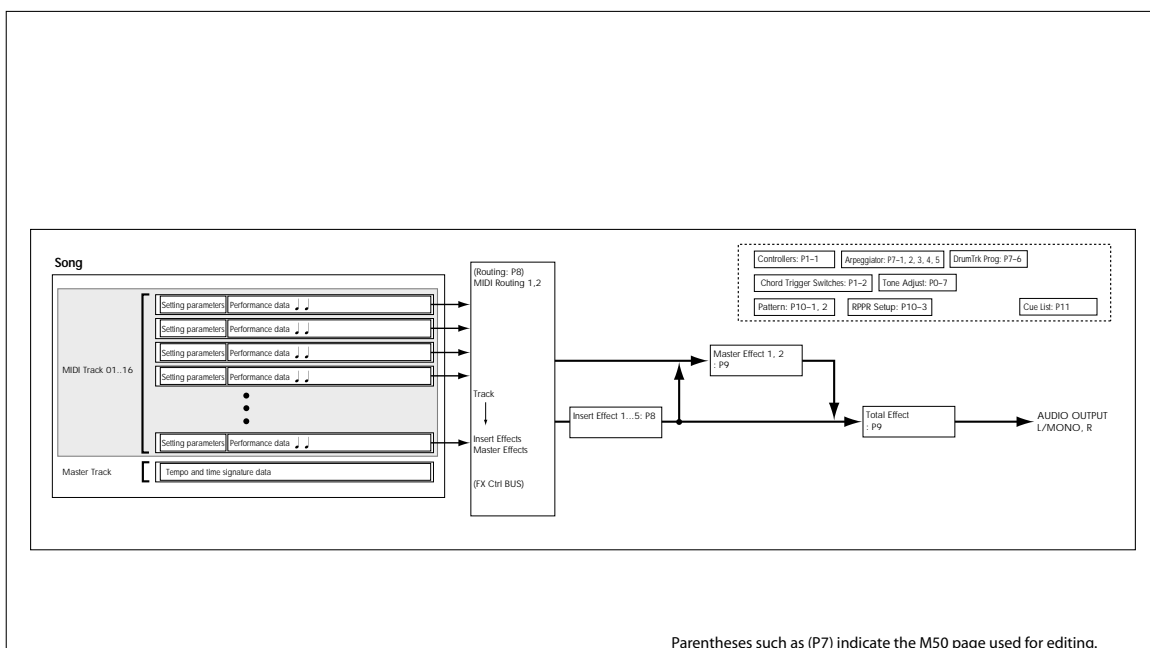

Patterns

There are two types of patterns: preset patterns and user patterns.

Preset patterns: Patterns suitable for drum tracks are preset in internal memory, and can be selected for any song.

User patterns: Each song can have up to 100 patterns. When using a pattern in a different song, use the Utility menu commands **Copy Pattern** or **Copy From Song** etc. to copy the pattern. The pattern length can be specified in units of a measure.

Each pattern consists of musical data for one track. It is not possible to create patterns that contain multiple tracks.

You can use these patterns by placing them in a MIDI track (**Put to Track** menu command) or by copying them (**Copy to Track** menu command). You can also use patterns with the RPPR function of a song.

Recording and editing a pattern

You can record a pattern in either of two ways: realtime recording or step recording. However, unlike realtime-recording to a track, you can select only one recording type (loop recording) when realtime-recording to a pattern.

You can edit the pattern to correct mistakes in the recorded data, or use event editing to insert new data.

You can use the **Get From Track** menu command to obtain a desired region of performance data from a MIDI track and use it as pattern data. Conversely, you can use the **Put to Track** or **Copy to Track** menu commands to place or copy a pattern's performance data into a MIDI track.

How Sequencer patterns are related to Drum Track patterns

The patterns of the Drum Track function you use with a Program or Combination are related to Sequencer mode patterns as follows.

Preset patterns are a common library that can also be used by the Drum Track function.

User patterns cannot be directly used by the Drum Track function, but they can be converted to user Drum Track patterns and used with a Program or Combination. If you convert a user pattern, it will be stored in internal memory, and this data will not disappear even when you turn off the power.

Cue List

The cue list allows you to playback multiple songs in succession. The M50 lets you create twenty cue lists. Each cue list lets you connect up to 99 songs and specify the number of times that each song will repeat.

The menu command **Convert to Song** lets you convert the songs in a cue list into a single song.

For example you can use a cue list to create the backing, convert the cue list to a song, and then add solo phrases on unused tracks.

Functions of each switch

PAUSE switch

This switch pauses the playback of the song. When paused, the switch's LED will light up. Press PAUSE once again to resume playback, and the LED will turn off.

<<REW switch

When the Song is playing or paused, this switch will rewind the song. When you press and hold this switch, its LED will light up, and the playback will rewind. (Rewind is disabled during recording, and while the Song is stopped.)

Note: You can use the **FF/REW Speed** menu command to specify the fast-forward and rewind speed.

FF>> switch

When the Song is playing or paused, this switch will fast-forward the song. When you press and hold this switch, the switch will light, and the playback will fast-forward. (Fast-forward is disabled during recording, and while the Song is stopped.)

LOCATE switch

This switch will advance or rewind the song to the specified locate point. This lets you jump immediately to any point in the current Song. The default locate point is the first beat of measure 1.

To set the locate point to the current position, hold down the ENTER switch and then press the LOCATE switch. You can also set the Locate point directly via the display menu.

START/STOP switch

This starts or stops recording and playback in Sequencer mode.

REC/WRITE switch

Pressing this switch will enter record-ready mode. Once you're in record-ready mode (shown by the switch's lit LED), you can begin recording by pressing the SEQUENCER START/STOP switch. For details, please see "Recording MIDI in real time" on page 57.

Playing Songs

Playback

In order to play back song data in the sequencer, you must first record, load or dump song data into the M50.

Let's start by loading and playing the demo song data. For details, please see "Listening to the demo songs" on page 5.

1. Press the **MODE SEQ** switch to enter **Sequencer mode**.

The P0-1: Play/REC- Program T01-08 or T09-16 page will appear. If this is not displayed, press the **EXIT** switch three times.

2. Use "**Song Select**" to select the song you want to play back.

You can press the Song Select popup button and choose from a list. If you select an empty list, a new song will be created.

You can also select a song by using the **VALUE** controllers. However if there is no song, you can't make a selection using the **VALUE** controllers.

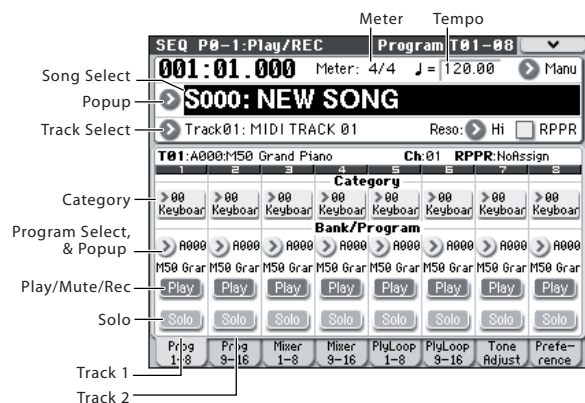

3. Press the **SEQUENCER START/STOP** switch.

The song you selected in step 2 will begin playing.

The song will begin playing if you press the **SEQUENCER START/STOP** switch in a page other than P10: Pattern/RPPR. If you press this switch while you're in P10: Pattern/RPPR, the currently-selected pattern will begin playing. (In P11: Cue List, the songs of the cue list will be played.)

4. **During playback, you can press the SEQUENCER START/STOP switch to stop playback.**

If you press the **START/STOP** switch once again, playback will resume from where you stopped.

For details on the functions of the **LOCATE**, **PAUSE**, **<<REW**, and **FF>>** switches, please see page 52.

You can use the **FF/REW Speed** menu command to specify the fast-forward and rewind speed.

- To set the tempo, turn the **TEMPO** knob or press the **TAP TEMPO** switch at the desired interval.

Changing the volume, mute, and solo settings of each track

In the SEQ P0-1: Play/REC Prog T01-08, T09-16, Mixer T01-08, and T09-16 pages you can change the volume, mute, and solo settings of each track.

For details, please see "SEQ P0: Play/REC" on page 129 of the Parameter Guide.

Muting just a specific track/ Monitoring just a specific track (Mute/Solo functions)

The M50 provides a Mute function that lets you silence specified MIDI tracks 1-16, and a Solo function that lets you hear the specified track or channel by itself. These functions can be used in various ways. For example you can intentionally mute or solo specific tracks, or listen only to the rhythm section of the previously-recorded tracks while you record new tracks. Let's try out the Mute and Solo functions.

1. Use "**Song Select**" to select the song that you want to play back.

2. Press the **SEQUENCER START/STOP** switch.

3. Press track 1 **Play/Rec/Mute**.

The display will change from **Play** to **Mute**, and the playback of track 1 will no longer be heard. In this way, the "mute" function allows you to silence a specified track until the track is un-muted.

Press track 2 **Play/Rec/Mute**. The display will change, and the playback of track 2 will also be muted. To cancel muting, press **Play/Rec/Mute** once again.



4. Press track 1 "**Solo On/Off**."

"Solo" will be highlighted, and this time, only the performance of track 1 will be heard. To play back only a specified track by itself in this way is known as "soling" the track (turning Solo on).

If both Mute and Solo are used, the Solo function will be given priority.

Press track 2 "**Solo On/Off**."

The display will change, and you will hear the playback of tracks 1 and 2. You won't hear the sound of MIDI tracks 3-16.



5. To switch Solo off, press **Solo On/Off** once again. Press **Solo On/Off** for both MIDI tracks 1 and 2.

The display will change, and the playback of tracks 1 and 2 will be muted. If the Solo function is turned off for all tracks, playback will be according to the **Play/Rec/Mute** settings.

Exclusive Solo

Normally, the Solo function operates in “Exclusive Solo off” mode, where you can solo more than one track at a time (as in the example above). In contrast, “Exclusive Solo on” mode allows only one track/channel to be soloed at a time, making it easy to switch between soloed tracks.

Use the **Exclusive Solo** menu command to specify how the Solo function will operate.

Exclusive Solo off: You will be able to solo more than one track at a time. The status of a track will change each time you press its Solo On/Off button.

Exclusive Solo on: When you press a Solo On/Off button, only that track will be soloed.

 The **SOLO** setting is not stored when you save the song.

Tip: You can turn Exclusive Solo on/off by holding down the ENTER switch and pressing numeric key 1.

If you play back from the first measure with the settings shown in the screenshot above, the specified region of measures will repeat as follows.

Measures	1	2	3	4	5	6	7	8	9	10	11	12	13
Track 1	1	2	3	4	5	6	7	8	5	6	7	8	5
Track 2	9	10	9	10	9	10	9	10	9	10	9	10	9

If **Play Intro** is unchecked, the specified region of measures will repeat as follows.

Measures	1	2	3	4	5	6	7	8	9	10	11	12	13
Track 1	5	6	7	8	5	6	7	8	5	6	7	8	5
Track 2	9	10	9	10	9	10	9	10	9	10	9	10	9

LOCATE settings

You can press the LOCATE switch to move to the registered location. Initially, this will move to 001:01.000.

To change the registered location, use the **Set Location** menu command. Alternatively, you can register a location during playback by holding down the ENTER switch and pressing the LOCATE switch.

When you select a song, the **LOCATE** setting is automatically initialized to 001:01.000.

For details, please see “Set Location (Set Location for Locate Key)” on page 192 of the Parameter Guide.

Loop playback

When recording or playing back a song, you can loop individual MIDI tracks that are playing.

In the P0-1: Play/REC- Play Loop T01-08 or T09-16 page, check **Track Play Loop** for the MIDI tracks you want to loop, and use **Loop Start Measure** and **Loop End Measure** to specify the starting and ending measure of the region that will play back as a loop.

If you check **Play Intro**, the measures preceding the loop will be played back as an introduction before the loop begins.

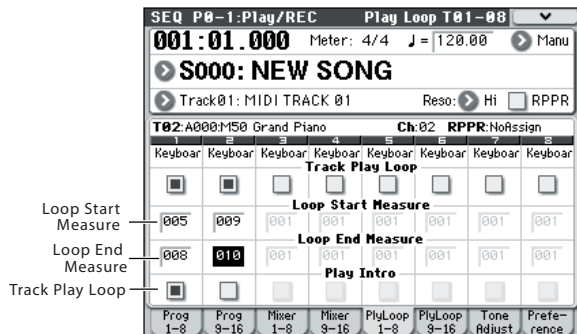

MIDI recording

Preparations for recording

-  Before you begin recording, make sure that the memory protect setting in Global mode is turned off. For details, please see “Memory protect” on page 90.

Creating a Song

Before we can begin this example, we need to select an empty song where we can record.

1. Press the **MODE SEQ** switch to enter Sequencer mode.
2. Choose “Song Select” (e.g., in the **P0-1: Play/REC-Program T01-08** page).

You can press the Song Select popup button, and choose from a list.

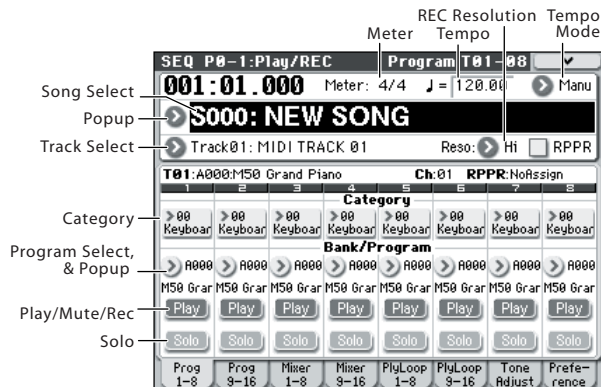

3. Use the numeric keys to input the number of the new song you want to create, and press the **ENTER** switch. (For example, press the 1 switch and then the **ENTER** switch.) A dialog box will appear.

If you pressed the Song Select popup to access the Song No. dialog box, press the desired song number to open the dialog box.



4. Use “Set Length” to input the desired number of measures and press the **OK** button.

You can change the number of measures later if desired. For details, please see “Set Song Length” on page 198 of the Parameter Guide.

5. Press the **OK** button to create the song.

Tip: You can use the **ENTER** switch instead of the **OK** button.

Track settings

Since we’re going to record a new song in this example, we will start by explaining how to assign a program to each MIDI track, and make basic settings such as volume.

1. Assign a program to each MIDI track.

Use “Program Select” to assign a program to each MIDI track. The method is the same as when assigning a program to a timbre in a combination (see page 45).

You can copy various settings from Programs or Combinations. (See PG page 126, page 120, and page 194)

2. When assigning a program, you can use **Track Select** to choose the track to which you wish to assign a program, and audition the sound.

3. Set the pan and volume of each MIDI track.

Press the **Mixer 1-8** tab (or the **Mixer 9-16** tab) to access the **Mixer T01-08** page (**Mixer T09-16** page).

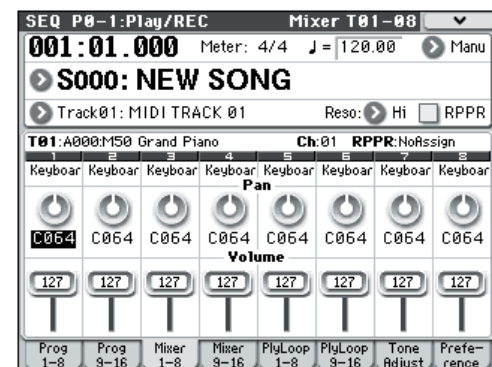

- **Pan** sets the pan position of each track, and **Volume** sets the volume level of each track.
4. Specify the tone generator and MIDI channel that will be played by each MIDI track.

Press the **PAGE SELECT** switch to access **SEQ Page Select**, and press “**P3 Track Param.**” The **P3: Track Param** page will appear. Press the **MIDI 1-8** tab (or the **MIDI 9-16** tab) to access the **MIDI T01-08** page (**MIDI T09-16** page).

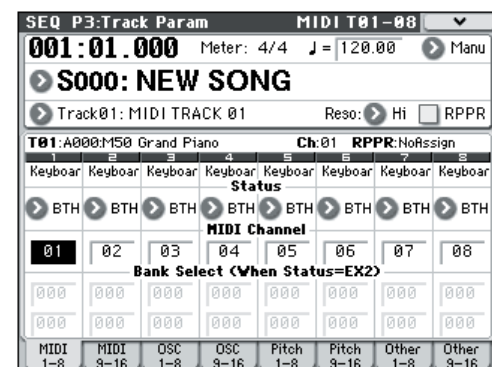

- Use **Status** to specify whether each track will play the internal and/or external sound generator.

Normally when using the M50 as a 16-timbre sound module, you will select **INT** or **BTH**.

INT: During playback, the M50's internal tone generator will play the MIDI data recorded on that track. When you operate the M50's keyboard or controllers, you will be playing and controlling the track selected by **Track Select**. MIDI data will not be transmitted to an external device.

EXT, EX2, BTH: During playback, the MIDI data recorded on that track will be transmitted from MIDI OUT to play an external sound module. When you operate the M50's keyboard or controllers, MIDI data will be transmitted to play and control the external sound module selected by **Track Select**. (The MIDI channel of the external tone generator must be set to match the **MIDI Channel** of M50 tracks that are set to EXT, EX2 or BTH.)

If **Status** is set to BTH, both the external tone generator and internal tone generator will be played and controlled.

- Use **MIDI Channel** to specify the MIDI channel for each track.
Normally you will set **MIDI Channel** to a different channel: 1–16 for each track. Tracks that are set to the same MIDI channel will sound simultaneously when you record or play back either of the tracks.

5. Adjust the effect settings.

Make settings for each effect in P8: IFX and P9: MFX/TFX.

For details, please see “Using effects in Combinations and Songs” on page 71.

6. Set the tempo and time signature.

- To set the tempo, you can turn the TEMPO knob or press the TAP TEMPO switch at the desired interval. Alternatively, you can select **♩ (Tempo)** in the P0–1: Play/REC– Program T01–08 page (or similar page), and use the VALUE controllers to set the tempo. Set **Tempo Mode** to Manual.
- Next you will set the time signature. In this example, we'll explain how to set the time signature using the “Meter” field. Normally, you specify the time signature before recording the first track, and then begin recording.
 - a) Press the SEQUENCER REC/WRITE switch, and set “Meter” to **/**.
 - b) Press **/** to highlight it, and use the VALUE controllers to set the time signature.
 - c) Press the SEQUENCER START/STOP switch to begin recording. When the pre-count has ended and Locate reaches 001:01:000, press the SEQUENCER START/STOP switch to stop recording. The time signature you specified has now been recorded on the Master track.
If you press the SEQUENCER START/STOP switch during the pre-count, the time signature won't be recorded.

7. Set the “REC Resolution” if necessary.

When you record in real time on a MIDI track, this parameter specifies how the timing of the recorded MIDI data will be corrected. The timing will also be corrected when you record automation data in real time on an audio track. (Already-recorded data will not be corrected.)

For example, let's suppose that you recorded some eighth notes in real time, but your timing was not quite perfect, as shown in part 1 of the illustration below. If **REC Resolution** were set to **♩** when you recorded, the timing would automatically be corrected as shown in part 2 of the illustration. If **REC Resolution** is set to **Hi**, the notes will be recorded with the timing at which you play them.



8. Make other settings as necessary.

Make settings for the arpeggiator (P7: ARP/DT), MIDI filtering (P5: MIDI Filter/Zone), etc.

For details, please see “Arpeggiator settings in Combination and Sequencer modes” on page 109 of the Parameter Guide.

You may also wish to use Tone Adjust to tweak the sound. When you are finished making these settings, the basic setup is complete.

Saving your song parameter settings

The song parameter settings you make here can be saved as a template. If you use these settings frequently, you can simply load one of the templates you've saved.

For details, please see “Save Template Song (Save as User Template Song)” on page 192 of the Parameter Guide.

Using template songs

Loading a template song is an easy way to make settings appropriate for a particular musical style. You can also assign a drum pattern to a track at the same time.

1. In the P0–1: Play/REC page, press the menu button and choose “Load Template Song.”

A dialog box will appear.

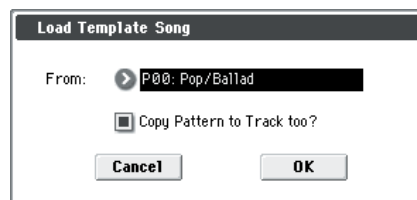

2. In the “From” field, choose the template song you want to load.
3. If you check “Copy Pattern to Track too?”, a dialog box for copying a pattern will automatically appear after you execute “Load Template Song.”

If you execute without checking this, only the template song you selected in step 2 will be loaded.

4. Press the OK button to load the template song, or press the Cancel button if you decide to cancel.

When you execute this operation, song settings other than MIDI Track Loop and RPPR will be copied.

If you executed this operation with **Copy Pattern to Track too?** checked in step 3, the **Copy Pattern To Track** dialog box will appear.

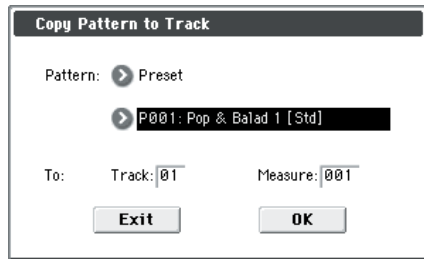

This dialog box is the same as the one that appears for the **Copy To Track** (P10: Pattern/RPPR- Pattern Edit) menu command.

5. In the “Pattern” field, select the pattern that you want to copy.

In the **To Track** field, select the copy-destination track. In the **Measure** field, specify the starting measure of the copy-destination.

Following the pattern name for each of the 671 preset patterns, the musical style and the name of the most suitable Drums category program are partially displayed.

By loading a drums track and the corresponding preset pattern, you can instantly set up a drum track appropriate for each preset template song.

6. To execute, press the OK button.

When you execute this operation, the **Measure** field will count up automatically, showing how many measures of the selected pattern have been placed in the selected song. You can then copy another pattern if desired, or add more measures of the same pattern. When you're finished, press the Exit button.

Copying the settings of a combination or program

You can copy the settings of a combination or program, and assign these settings to a track.

For details, please see “Recording the sound of a Combination or Program” on page 60.

Recording MIDI in real time

When you've finished with “Preparations for recording,” you can start recording.

This is a method of recording in which your playing on the keyboard and your operations of controllers such as the joystick are recorded in real time. This method of recording is normally used one track at a time, and is called single track recording.

As an alternative, multitrack recording allows you to simultaneously record multiple channels of data onto multiple tracks. This is the method you will use when using the Drum Track function, the RPPR function, and the arpeggiator to record multiple tracks of musical data at once, or when you play back existing sequence data on an external sequencer and record it onto M50's sequencer in real time.

Recording setup

In P0-1: Play/REC- Preference page **Recording Setup**, select the realtime recording method you want to use.

Overwrite

When recording for the first time, you will normally select this method.

If you use this method to record on a track on which data has already been recorded, all data will be replaced for the measure at which you began recording and at all subsequent measures.

Normally you will use this method to record, and then modify the results by using other types of real-time recording or MIDI event editing.

1. Use **Track Select** to choose the track that you want to record.
2. Set the **Recording Setup** to **Overwrite**.

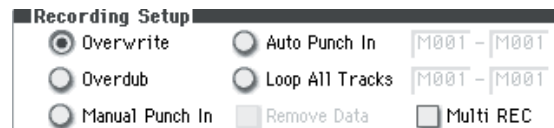

3. In “**Location**,” specify the location at which you wish to begin recording.
4. Press the **SEQUENCER REC/WRITE** switch, and then press the **START/STOP** switch.

If the **Metronome Setup** is still set to the default settings, the metronome will sound for a two-measure pre-count, and then recording will begin. Play the keyboard and move controllers such as the joystick to record your performance.

5. When you finish playing, press the **START/STOP** switch.

Recording will end, and the location will return to the point at which you begin recording.

If you press the **PAUSE** switch instead of the **START/STOP** switch, recording will pause. When you press the **PAUSE** switch once again, recording will resume where you left off before pausing. When you are finished, press the **START/STOP** switch to stop recording.

The following recording setup parameters are also available. For details, please see PG page 137.

Overdub

Select this method when you wish to add data to a previously-recorded track. (except for audio events)

If you use this method to record on a track on which data has already been recorded, the previously-recorded data will remain, and the newly-recorded data will be added to it.

Manual punch-in

Select this method when you wish to use the **SEQUENCER REC/WRITE** switch or a foot switch to re-record selected portions of a previously-recorded track.

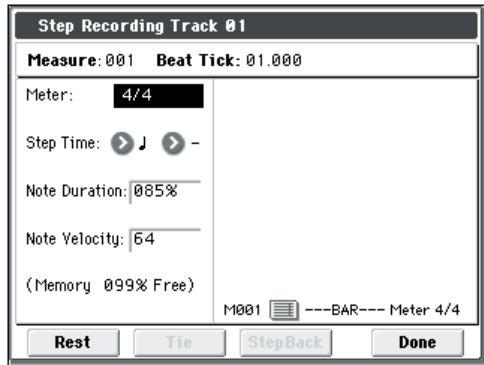

5. In “Step Time,” use “Select” to specify the basic timing value at which you will input notes and rests.

Input the first C3 note as ♩. (dotted eighth note).

Use the popup button at the left to select ♩. .

You can choose a note value ranging from a whole note (♩) to a 32nd note (♩).

Input a dotted note by selecting “.” with the popup buttons at right.

You can specify “3” to input a triplet. If you want to use the unmodified length of the note that’s selected at the left, choose “-”.

“Note Duration” indicates the length that the note itself will sound. Smaller values will produce a staccato note, and larger values will produce a legato note. For this example, leave this setting unchanged.

“Note Velocity” is the velocity (playing strength), and larger values will produce a louder volume. Set this to Key.

If you select Key for this parameter, the velocity with which you actually play the keyboard will be input.

6. On the keyboard, press and then release the first C3 note that you want to input.

The data you input will appear in the display as numerical values. In the upper right, Measure 001 Beat Tick 01.000 will change to Measure 001 Beat Tick 01.360. The next note you input will be placed at this location.

7. Input the remaining notes as described in steps 5 and 6. (You’ve already input the first C3 note.)

In addition to the methods described in steps 5 and 6, you can also use the following input methods.

- To input a rest, press the Rest button. This will input a rest of the selected **Step Time** value.
- To modify the length of a note, you can modify the **Step Time** value before you input the note. However if you want to extend the length (tie) of the note, press the Tie button. At this time, the previously-input note will be extended by the **Step Time** length.
- To delete a note or rest that you input, press the Step Back button. The previously-input note will be deleted.
- To input a chord, simultaneously press the notes of the desired chord. Even if you do not press them simultaneously, notes that are pressed before you fully remove your hand from all keys on the keyboard will be input at the same location.

- If you want to verify the pitch of the note that you will input next, press the PAUSE switch. In this state, playing a key will produce a sound, but will not input a note. Press the PAUSE switch once again to cancel the record-pause state, and resume inputting notes.

Note	Step Time: Select	Step Time: . 3 -	Key, Button	Measure/ Beat Tick
C3	♩.	.	C3 key	001 / 01.000
G3	♩.	-	G3 key	001 / 01.360
♩	♩.	-	Rest button	001 / 02.000
C4	♩.	-	C4 key	001 / 02.240
♩	♩.	-	Rest button	001 / 02.360
C4	♩.	-	C4 key	001 / 03.120
D3	♩.	-	D3 key	001 / 03.240
Eb3	♩.	-	Eb3 key	001 / 04.000
E3	♩.	-	E3 key	001 / 04.240
F3	♩.	-	F3 key	002 / 01.000
♩	♩.	-	Rest button	002 / 01.120
C3	♩.	-	C3 key	002 / 01.360
♩	♩.	-	Rest button	002 / 02.000
F2	♩.	-	F2 key	002 / 02.240
Tie	♩.	-	Tie button	002 / 03.000
F2	♩.	-	F2 key	002 / 03.240
♩	♩.	-	Rest button	002 / 03.360
A2	♩.	-	A2 key	002 / 04.000
A3	♩.	-	A3 key	002 / 04.240
♩	♩.	-	Rest button	002 / 04.360

8. When you are finished recording, press the Done button.

Press the SEQUENCER START/STOP switch to play back.

Access the P0: Play/REC- Play Loop T01-08 page, check **Track Play Loop** for MIDI Track 02, set **Loop Start Measure** to 001, and **Loop End Measure** to 002. MIDI track 02 will play measures 1-2 repeatedly.

9. If you’re not satisfied with the result, press the COMPARE switch to return to the state prior to recording, and then re-record from step 4.

⚠ When you begin step recording, all data in the MIDI track that follows the measure where you began recording will be erased. You need to be aware of this if you begin step recording from a measure mid-way through the song.

If you want to copy data into a measure that already contains data, perform step recording in an empty MIDI track, and use the **Move Measure** or **Copy Measure** menu commands. For details, please see “Copy Measure” on page 200 of the Parameter Guide, and “Move Measure” on page 201 of the Parameter Guide.

If you want to edit or add to the recorded data, you can use the **Event Edit** function. For details, please see “Event Edit” on page 196 of the Parameter Guide.

Recording variation

Recording the sound of a Combination or Program

Here's how you can easily copy the settings of a Combination or Program, and then record using that sound.

When you're performing in Program or Combination mode, you can use the Auto Song Setup function to automatically transfer the settings of that program or combination into a song. Alternatively, you can use the Sequencer mode menu commands **Copy From Combi** and **Copy from Program** to set up a song in a similar way.

Auto Song Setup function

The explanation of the Auto Song Setup function given here follows the procedure from Combination mode.

1. Enter Combination mode.
2. If you change any of the settings in the combination in the Combi P0: Play- Program T01-08 page.

Such as panning, volume and arpeggiator setting you must first save the edited settings using **Update Combination** or **Write Combination**.

3. Hold down the ENTER switch and press the SEQUENCER REC/WRITE switch.

The Setup to Record dialog box will appear.

4. Press the OK button to perform the Auto Song Setup.

The M50 will automatically switch to Sequencer mode, and the combination's settings will be applied to a new song. The new song will be the first unused song.

5. You will automatically enter record-ready mode, and the metronome will begin sounding according to the settings in P0-1: Play/REC- Preference page.
6. Press the SEQUENCER START/STOP switch, and real-time recording will begin.

When you're finished recording, press the START/STOP switch once again.

Setup in Sequencer mode (Copy From Combination/Copy From Program)

In Sequencer mode, you can use the **Copy From Combi** and **Copy From Program** menu commands to set up a sequencer song based on a combination or program. In this example, we'll explain how to set up a song based on a combination.

Note: Make sure that the global MIDI channel (Global P1: MIDI- MIDI Basic page, **MIDI Channel**) is set to 01.

1. Create a new song.

For details, please see "Creating a Song" on page 55.

2. Select the menu command "Copy From Combi."

A dialog box will appear.

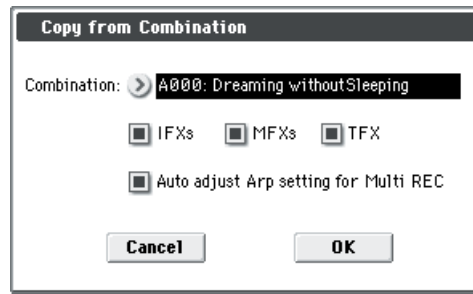

Select the program or combination that you want to copy (i.e., the copy source).

We will copy the effect settings of the combination as well, so check the **IFXs**, **MFXs** and **TFX** check boxes.

Check **Auto adjust Arp setting for Multi REC**. The **Status** will be automatically set to REC for the MIDI tracks needed to record that combination.

Press the OK button to execute the copy.

Notice that when you execute this command, the **Play/Rec/Mute** setting of each track will be set automatically. The **Multi REC** check box will be checked.

3. Begin recording.

Press the LOCATE switch to set the location to 001:01.000.

Press the SEQUENCER REC/WRITE switch, and then press the SEQUENCER START/STOP switch.

Note: If you play the keyboard during the pre-count before recording, the phrase generated by the Drum Track function, and arpeggiator will start playing the moment recording begins. Record your performance.

4. When you are finished performing, press the SEQUENCER START/STOP switch.

If you made a mistake or want to re-record, you can use the Compare function (press the COMPARE switch) to re-record as many times as you want. (The **Multi REC** check box will be unchecked when you use Compare, so you will need to check it again.)

Using the Drum Track function and the arpeggiator to record on multiple MIDI tracks simultaneously

You can use multi-recording to simultaneously record a multi-track performance using the Drum Track function and arpeggiator.

For details, please see "Arpeggiator settings in Combination and Sequencer modes" on page 109 of the Parameter Guide.

Using the RPPR function to record on multiple MIDI tracks simultaneously

You can use multi-recording to simultaneously record a multi-track performance using the RPPR function.

For details, please see "Creating an RPPR pattern" on page 63.

Recording multiple MIDI tracks from an external sequencer

The playback from an external MIDI sequencer connected to the M50 can be recorded simultaneously using multi-recording.

For details, please see “Recording multiple MIDI tracks from an external sequencer” on page 140 of the Parameter Guide.

Recording System Exclusive events

Exclusive messages received from an external MIDI device or the parameter changes produced when you edit a MIDI track parameter or effect parameter can be recorded in real time on any MIDI track.

During playback, the exclusive messages you recorded will control the track parameters and effect parameters of the song, and can be sent to external MIDI devices.

Note: You can use the menu command **Put Effect Setting to Track** to insert an exclusive event containing the parameter settings for an insert effect, master effect or total effect into the desired location of a track, so that these settings will automatically switch during playback.

MIDI GM, XG, and GS exclusive messages can be recorded on a track, but the M50's tone generator will not respond to these messages.

For details, please see “Recording internal parameter changes” on page 212 of the Parameter Guide.

Using the control surface to record changes in the pan, EQ, volume, and tone adjust settings of a MIDI track

While performing real-time recording, you can use the control surface to modify the pan, EQ, volume, and tone adjust settings to record these changes so that they will be reflected during the playback.

Use multi-track recording if you want to modify the settings of multiple tracks simultaneously.

Note: Controlling these parameters will transmit control change or system exclusive messages. In order for this data to be recorded, the Global P1: MIDI- MIDI Routing **Enable Control Change** and **Enable Exclusive** settings must be checked. Go to Global mode and verify that these items are checked.

Note: Use **Param. MIDI Out** in Global P1: MIDI Basic page to specify whether control change messages or system exclusive messages will be transmitted when you edit the Pan (CC#10), Volume (CC#7), or Send 1/2 level (CC#93 and CC#91) parameters.

In this case, the Global P1: MIDI- MIDI Routing settings **Enable Control Change** and **Enable Exclusive** must be checked respectively.

Recording patterns in real time

Here's how you can use real-time recording to create a pattern. User patterns can be accessed by the RPPR function in the same way as preset patterns, and can be copied to or placed in a song. Playback data from a track can also be copied to a pattern.

In addition, you can use the menu command **Convert to Drum Trk Pattern** to convert a user pattern to a user Drum Track pattern for use with the Drum Track function. (See page 60)

When realtime-recording a pattern, a pattern of the specified number of measures will play back repeatedly, allowing you to continue adding musical data to it.

1. Create a new song, and as described in “Preparations for recording” on page 55, set the track to the program that will be used by the pattern.
2. Access the P10: Pattern/RPPR- Pattern Edit page.

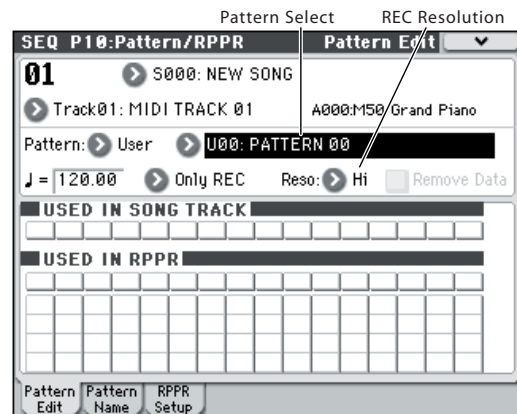

3. Use Track Select to choose the track that you will use to record the pattern.

The pattern will play back with the program and other settings of the selected track.

4. Set “Pattern (Pattern Bank)” to User, and set “Pattern Select” to U00.

User patterns U00–U99 can be created for each song.

5. Select the menu command “Pattern Parameter”.

A dialog box will appear.

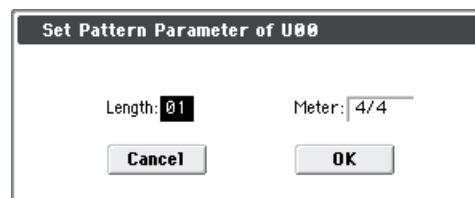

6. Set the number of measures in the pattern to a “Length” of 04 (four measures), and set “Meter” to a time signature of 4/4. Press the OK button.

7. As necessary, set “REC Resolution” to apply realtime quantization.

8. Begin realtime recording.

You can record in the same way as you did when recording tracks with Loop All Tracks. (See “Loop All Tracks” on page 58)

Press the SEQUENCER REC/WRITE switch, and then press the SEQUENCER START/STOP switch.

After the pre-count, pattern recording will begin. Play the keyboard and operate the joystick and other controllers to record your performance.

When you reach the end of the pattern, the sequencer will return to the beginning of the pattern and continue recording. If you continue recording, the newly recorded data will be added to the previously-recorded data.

9. If you want to delete specific data while you continue pattern recording, you can press the SEQUENCER REC/WRITE switch or check the "Remove Data" check box.

For details refer to step 6 of "Loop All Tracks" on page 58.

10. Press the SEQUENCER START/STOP switch to stop recording.

If you made a mistake or decide to re-record, press the SEQUENCER START/STOP switch to stop recording, and press the COMPARE switch. Then begin the pattern recording procedure again as in step 8.

Song editing

You can apply a variety of editing operations to a song. For details, please see PG page 191.

Creating an RPPR pattern

RPPR stands for Realtime Pattern Play/Recording, and is a function that lets you assign pattern data to each key, and then play back that pattern simply by pressing the key to which it is assigned. You can realtime-record this performance.

For details, please see “10–3: RPPR Setup” on page 184 of the Parameter Guide.

Creating RPPR data

1. Create a new song, and choose a drum program for MIDI track 1.
 2. Access the P10: Pattern/RPPR– RPPR Setup page. In this page, the RPPR function is automatically turned on.
 3. Select the key to which the pattern will be assigned.
 4. Select C#2.
- Hold down the ENTER switch and play a key.
- Note:** C2 and lower keys are used to stop playback, and cannot be assigned patterns.
5. Check “Assign” for C#2.
 6. Set “Pattern Bank” to Preset, and set “Pattern Select” to P001.
 7. Set “Track” to Track01.

The selected pattern will be played according to the settings (program, etc.) of the track you select here.

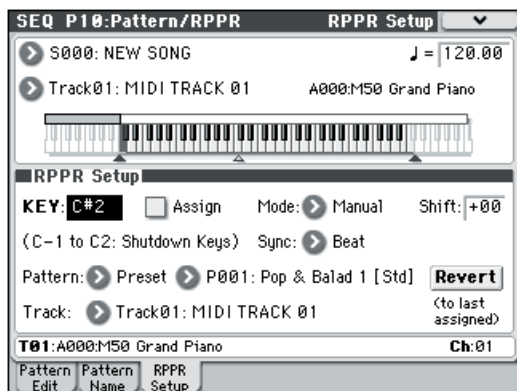

8. Assign patterns to other keys. For “KEY,” press the Δ switch to select D2.
9. Press the Revert button. The Assign, Pattern Bank, Pattern Select, and Track settings will be given the previously (steps 5–7) specified values.
10. Choose “Pattern Select,” and press the Δ switch to select P002.

By using Revert in this way, you can work efficiently when assigning contiguous (or nearby) pattern numbers or tracks.

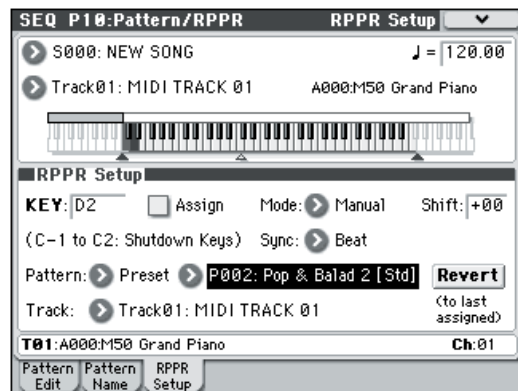

- As described above, assign several other patterns such as P003 and higher.
11. Press the C#2 key. The assigned pattern will play.
 12. Take your finger off the C#2 key, and press the D2 key. The pattern will change, and playback will begin. At this time, the pattern operation will depend on the Sync and Mode setting.
 13. Set KEY to C#2, and set Sync to Measure. Make the same setting for D2 (see the diagram above).

Now press the notes consecutively. Notice that the patterns operate in a different way.

With the Measure setting, patterns will be handled in one-measure units. The second and subsequent patterns will start in sync with the end of previously played pattern.

If you change the Mode setting to Once, the entire pattern will playback to the end even if you release your finger from the keyboard immediately.

- To stop playback, either press the same key once again, or press the C2 or lower key.

For details on Sync, Mode, and Shift, please see PG page 185.

- The assigned keys are also shown in the keyboard graphic in the display.
- Keys to which no pattern is assigned can be played normally. Use Track Select to select the track you want to play. For example you could assign backing patterns for drums or bass to keys C#2–B2 and use these keys to control the pattern playback, while using the keys C3 and above to play a solo performance in realtime. It’s a good idea to keep your RPPR assignments within a specific range of keys.

RPPR playback

Let's use the RPPR you created to perform in the P0-1: Play/REC- Program T01-08 page.

1. Access the P0-1: Play/REC- Program T01-08 page.



2. Check the “RPPR” check box.

The RPPR function will be turned on. Set the RPPR on/off for each song.

3. Play the keyboard, and patterns will begin playing according to the RPPR settings.

If you wish to trigger the RPPR function from an external MIDI device, use the MIDI channel that is selected for **Track Select**.

- Pattern playback for keys whose **Sync** setting is Beat or Measure will synchronize to the pattern playback of the very first key played.
- If you are playing the pattern in synchronization (when **Sync** is Beat, Measure, or SEQ), the pattern will start accurately if you play the note slightly earlier than the timing of the beat or measure. Even if you play the note slightly later than the beat or measure (but no later than a 32nd note), it will be considered to have started at the beat or measure, and the beginning of the pattern will be compressed so that the remainder of the playback will be correct.

4. To turn off the RPPR function, uncheck the RPPR check box.

Play RPPR while a song plays back

RPPR can be played in synchronization with the playback of a song.

Pattern playback for a key with a **Sync** setting of SEQ will synchronize to the playback of the song. (See “Sync” on page 173 of the Parameter Guide) Start the song playback, and then press the key. The pattern playback will start in synchronization with the measures of the song.

⚠ Synchronization will be lost if you use the << REW or FF >> switches while a song is playing.

Note: If you want RPPR pattern playback to begin at the moment that song playback begins, it is a good idea to insert an empty measure containing no musical data before the song playback begins.

Note: If the song is stopped, the pattern will synchronize to the timing of the arpeggiator.

Realtime-recording an RPPR performance

You can record the realtime performance generated by RPPR.

For details, please see “Recording an RPPR performance” on page 186 of the Parameter Guide.

Creating and playing a Cue List

A cue list allows you to play multiple songs in succession. For example you can create a separate song for each portion (introduction, melody A, melody B, chorus, and ending) of a composition, and use the cue list to specify the order of each portion and the number of times that it will be repeated to complete the song. If you want to change the structure of the song, the cue list lets you do so in an efficient way.

You can also use this as a jukebox function that will play back completed songs in the order you specify. For details, please see “SEQ P11: Cue List” on page 188 of the Parameter Guide.

Step	Song	Repeat
01	S000: Intro	02
02	S001: A	02
03	S002: B	01
04	S003: Chorus	02
05	S001: A	02
06	S002: B	01
07	S003: Chorus	02
08	S001: A (Solo)	01
09	S003: Chorus	03
10	S004: Ending	02

Intro	Intro	A	A	B	Chorus
Chorus	A	A	B	Chorus	Chorus
A(Solo)	Chorus	Chorus	Chorus	Ending	Ending

3. Set the last step to End.

If you set this to Continue to Step01, the cue list will play back repeatedly.

4. In “Repeat,” specify the number of times that the song for that step will be repeated. For this example, set Step 02 S001: VERSE to 02.

5. Specify whether effect settings will also be switched when the song at each step is played back. If you want to effect settings to change, check the “FX” check box.

For this example, check the “FX” check box for Step 01, which loads the effects.

6. To play back at the tempo that was specified for each song, set “Tempo Mode” to Auto.

If this is set to Manu (Manual), playback will use the tempo specified by “J=”.

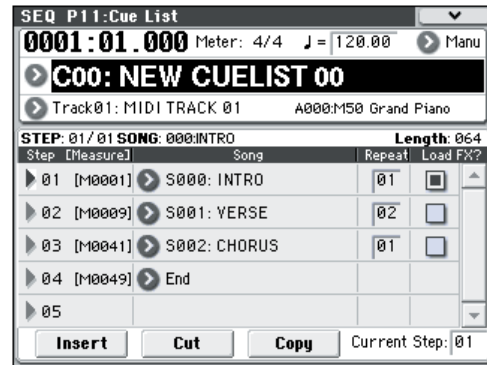

7. When you press the SEQUENCER START/STOP switch, playback will begin from the step that is specified as the “Current Step.”

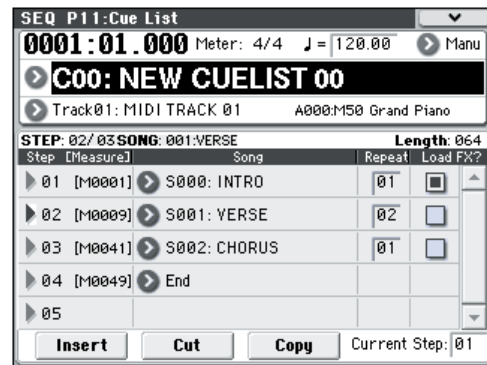

Creating a cue list

Each unit in a cue list is called a “step,” and each step contains a song number and the number of repeats.

For example, suppose you’ve created the songs S000: INTRO, S001: VERSE, and S002: CHORUS. Let’s use a cue list to connect these songs together.

1. Access the Seq P11: Cue List page.

With the default settings, song S000 will be selected for “Step” 01, and End will be selected for “Step” 02.

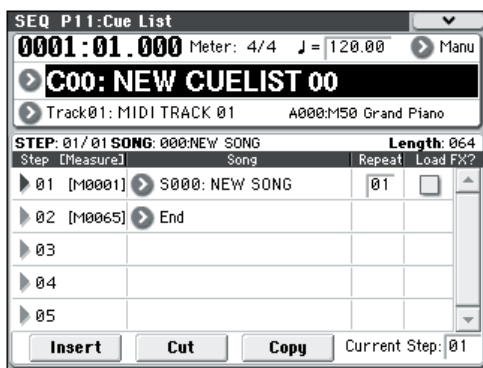

2. Add a song to the Step area.

Select the “Song” for Step 02, and press the Insert button. A song will be added to step 02. Use the VALUE controller to select S001: VERSE.

In the same way, select the Step 03 “Song,” and press the Insert button to add a song to Step 03. Set this to S002: CHORUS.

If you press Cut button, the selected step will be deleted. If you press the Insert button, the deleted step will be inserted.

If you press the Copy button, the selected step will be copied. If you press the Insert button, the copied step will be inserted.

- **Step:** The arrow will indicate the currently playing step. ▶ indicates the currently selected “Step.” If you set **Current Step** while stopped, the display will change.
- **M***:** Indicates the starting measure of that step.
- **Meter:** Indicates the currently-playing time signature. This cannot be changed.
- The name of a cue list can be specified by the **Rename Cue List** menu command.
- When you play the keyboard, the program of the track selected by **Track Select** will sound. If a different program is selected for each song, the program specified for the currently playing song will play.

Converting a cue list to a song

The **Convert to Song** menu command lets you convert a cue list to a single song.

For details, please see “Convert to Song (Convert Cue List to Song)” on page 209 of the Parameter Guide.

Saving your song

To ensure that the data you’ve created will be reproduced faithfully, we recommend that you use **Save All** to save it.

For details, please see “Saving to media” on page 87.

 When you turn off the power, the Sequencer mode settings, the recorded songs, and the user pattern data will be lost.

Saving a template song

If you want the programs, track parameters, effect settings, and arpeggiator settings etc. used by a song to be saved as a Template song, use the **Save Template Song** menu command to save these settings.

Using Effects

An overview of the M50's effects

You can choose from 170 different types of high-quality digital effects. The M50 provides five insert effects, two master effects, and one total effect, together with a mixer section that controls the routing of these effects. All of these are stereo in/out.

Specific parameters of these effects can also be controlled in real time from the M50's controllers or via MIDI messages using Dynamic Modulation (Dmod), by MIDI/Tempo Sync, or by using a common LFO to apply synchronized changes to multiple modulation effects.

Total Effect

The total effect (TFX) is stereo-in/stereo-out. The Dry (unprocessed) side of the **Wet/Dry** parameter sends the stereo input sound directly to the stereo output. The way in which the Wet (processed) side is output depends on the type of effect, as follows.

Wet	Mono In - Mono Out	
	Mono In - Stereo Out	
	Stereo In - Stereo Out	

Note: The Parameter Guide includes block diagrams for each individual effect, which include the effect's input/output structure. (See PG page 287)

Effect I/O

Insert Effects

Insert Effects (IFX 1-5) are stereo-in/stereo-out. If you select Dry (unprocessed) for the **Wet/Dry** parameter, the stereo input signal will be output in stereo without being processed by the effect. If you select Wet (effect applied), the processed signal will be output in one of the following ways:

Wet	Mono In - Mono Out	
	Mono In - Stereo Out	
	Stereo In - Stereo Out	

Master Effects

Master Effects MFX1 and MFX2 are stereo-in/stereo-out. **Send1** and **Send2** determine the send level to the Master Effects.

With Master effects, only the Wet (processed) signal will be output. The output signals from the Master Effects are routed to the L/R bus with the output level specified by **Return1** and **Return2**. These output signals are mixed with the output signals from the bus specified by **Bus (IFX/Output) Select** (P8- Routing page in each mode) L/R, or with the output signals from the bus specified by **Bus (IFX/Output) Select** (P8- Insert FX Setup page in each mode) L/R, then routed to the total effect.

Selecting "000: No Effect" will mute the output. The processed signal will be output in one of the following ways, according to the type of effects.

Wet	Mono In - Mono Out	
	Mono In - Stereo Out	
	Stereo In - Stereo Out	

Effects in each mode

Program mode

For programs, you can use insert effects to process the final sound in the same way that you use the Filter, Driver, Amplifier, and EQ (equalizer) to process the sound from the oscillators (OSC 1 & 2). Next, the master effects are used to create overall ambience such as reverb, and you use the total effect to make final adjustments. You can apply an effect in the same way to the output of a drum track program. All of these settings can be made independently for each program.

Combination and Sequencer modes

In Combination and Sequencer modes, you can use the track EQ and insert effects to process the sound of each timbre/track program. Then you can use the master effects to create overall ambience, and use the total effect to make final adjustments.

In Combination mode, you can make these settings for each combination, and in Sequencer mode you can make them for each song.

In Sequencer mode, you can switch between effects or modify the effect parameters and record these changes, so that effects will switch automatically or effect parameters will be modified automatically as the song plays back.

Program mode

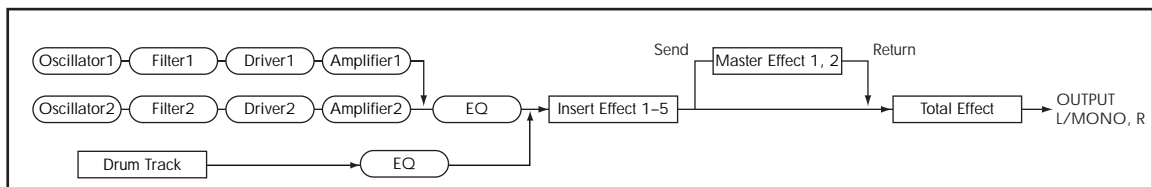

Combination and Sequencer modes

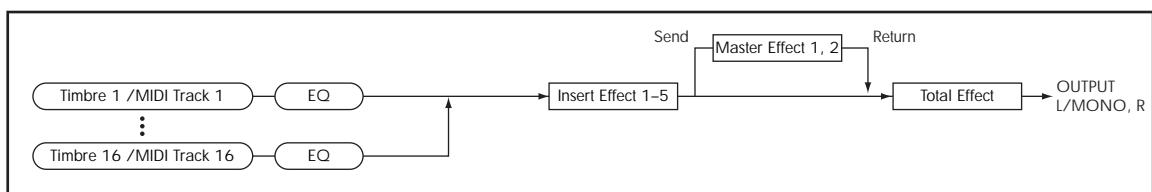

Routing effect settings

The insert effects, master effects, and total effect have the same structure in all modes, but the routing settings will determine how the oscillators of a program or the timbres of a combination or track of a song will be sent to each insert effect, master effect or total effect. In the pages that follow, we will explain how you can make routing settings and effect settings in each mode.

Program Effects settings

Routing

1. Access the Prog P8: IFX– Routing page.

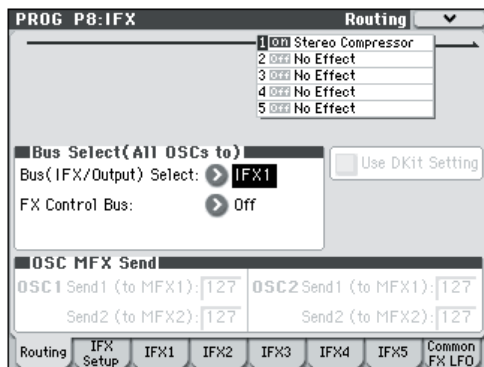

2. Use Bus (IFX/Output) Select to specify the bus to which the oscillator output will be sent. If you want the oscillator output to be input to insert effect 1, choose IFX1.

L/R: The output will not be sent to the total effect. After bypassing the total effect, the sound will be sent to AUDIO OUTPUT L/MONO and R.

IFX1–5: The output will be sent to insert effect IFX 1–5.

Off: Choose this if you want the signal to be connected in series to the master effects at the send levels specified by **Send 1 (to MFX1)** and **Send 2 (to MFX2)**.

3. OSC MFX Send specifies the send level from each oscillator to the master effects.

This can be set only when **Bus (IFX/Output) Select** is either L/R or Off.

If **Bus (IFX/Output) Select** is set to IFX1–5, the send level to the master effects is set by **Send1** and **Send2** (Insert FX Setup page) after the signal passes through the insert effects.

4. FX Ctrl sends the oscillator 1 and 2 output to the FX Control bus. Use this if you want the audio input to the effect to be controlled by a different sound.

You can use the two FX Control buses to control effects freely. For details, please see “FX Control Buses” on page 274 of the Parameter Guide.

Insert effects

5. Access the Prog P8: IFX– Insert FX Setup page.

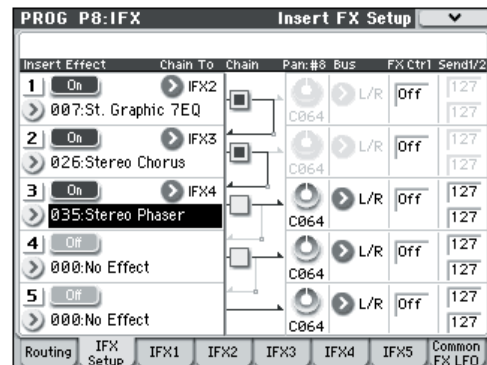

6. Choose the effect type that you want to use for each insert effect IFX1–5.

When you press the popup button, all effects will be displayed, organized into ten categories. Use the pages located at the left and right to select a category, and choose an effect from the desired category on the display.

You can use the **Copy Insert Effect** menu command to copy effect settings from another program etc. Also, you can use **Swap Insert Effect** to exchange (for example) IFX1 and IFX5.

7. Press the On/Off button to turn on the insert effect.

Each time you press this button, the insert effect will toggle on/off. When Off, the result will be the same as when 000: No Effect is selected; the sound will be output without being processed by the insert effect.

8. Make Chain settings.

If the **Chain** check box is checked, the insert effect will be connected in series. Since the output of the oscillator is being sent to IFX1 in step 2, making settings as shown in the diagram step 6 would connect all five insertion effects IFX1 → IFX2 → IFX3 in series, so that these effects would be inserted into the output of the oscillator.

9. Make settings for Pan: #8, Bus (Bus Select), Send 1, Send 2 and FX Ctrl for the sound after it has passed through the insert effects.

If you've specified a chain, the settings that follow the last IFX in the chain will be valid (except for **FX Ctrl**).

Pan: #8: Sets the pan of the IFX output.

Bus (Bus Select): Specifies the output destination. Normally you will set this to L/R.

Send 1, Send 2: Sets the send levels to the master effects. For this example, set this to 127.

FX Ctrl: The FX Control Buses lets you create effects “sidechains.” Sidechains let you control an effect with one audio signal (the sidechain), while the effect processes a completely different audio signal. This is convenient for use with vocoders, compressors and limiters, gates, etc. For details, please see “FX Control Buses” on page 274 of the Parameter Guide.

10. Access the P8: IFX- IFX page, and edit the parameters of the insert effect you selected.

Press the IFX 1-5 tabs and edit the parameters.

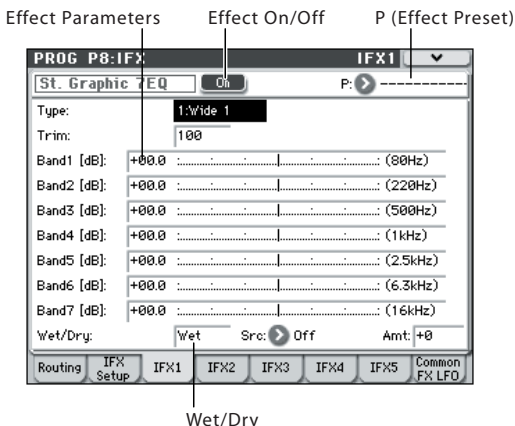

Effect 1 On/Off: Turns the insert effect on/off. This is linked with the on/off setting in the Insert FX Setup page.

P (Effect Preset): Selects an effect preset. The M50's internal memory contains "effect presets" which are parameter settings for each effect from 001: Stereo Compressor through 170: Early Reflections.

Effect parameters you edit are saved as part of each program, but effect presets allow you to save and recall your favorite parameter settings for each effect. If you've come up with an effect setting you like, use the menu command **Write FX Preset** to save it as a preset so that you can easily recall it in a different program or mode.

Double-size effects

Double-size effects (154: St.Mltband Limiter - 170: Early Reflections) use twice as much space as other effects.

You can use double-size effects for insert effects IFX1-IFX4 and master effect MFX1. However, because it takes up two units of effects power, the next-numbered effect will be unavailable. For example, if you've selected a double-size effect for IFX1, you won't be able to use IFX2. If you've selected a double-size effect for MFX1, you won't be able to use MFX2.

An example of when a double-size effect is selected for IFX1 and IFX4

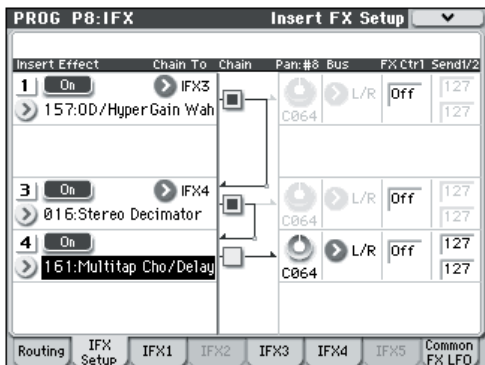

Master effects

11. The input levels to the master effects are set by the Send 1, 2 levels (step 3 or 9). If Send 1, 2 are zero, the master effects will not apply. Send 1 corresponds to MFX1, and Send 2 corresponds to MFX2.

12. Access the Prog P9: MFX/TFX- Routing page.

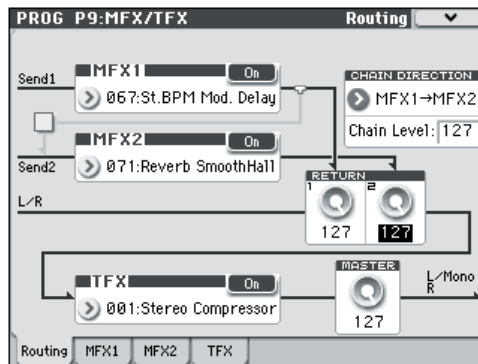

13. In MFX1 and MFX2, select the type of each master effect.

The procedure is the same as when selecting an insertion effect (see step 6).

Note: You can only select a double-size effect for MFX1. For details, please see "Double-size effects" on page 70.

14. Press the On/Off button to turn on the master effect.

Each time you press this button, the master effect will toggle on/off. When Off, the output of the master effect will be muted.

15. Use Return 1 and Return 2 to adjust the output levels of the master effects.

Note: For each effect, the Wet value of the **Wet/Dry** parameter is the output level of the effect. The return value is multiplied with this ("Return" = 127 will be x1.0) to determine the actual output level of the master effect.

16. Select the MFX1 and MFX2 pages, and set the parameters for each selected effect.

For details on the "Program Effects settings" step 10.

Total Effect

17. If you use Bus (IFX/Output) Select to choose L/R as the oscillator output, or if you set the post-IFX Bus to L/R, the signal will be input to the total effect.

The output from the master effects is input to the total effect via the Return 1 and Return 2 settings of the Prog P9: MFX/TFX- Routing page.

After being processed through the total effect, the signal is output from the AUDIO OUTPUT L/MONO and R outputs.

18. Access the Prog P9: MFX/TFX- Routing page.

19. Choose the desired total effect for TFX. The procedure is the same as when selecting an insert effect. (See step 6)

You can't use a double-size effect as the total effect.

For details, please see “Double-size effects” on page 70.

20. Press the On/Off button to turn the total effect on.

The total effect will toggle on/off each time you press the button. If this is Off, the result will be the same as if 000: No Effect is selected. The input sound will be output without being processed by the total effect.

21. Access the TFX page, and edit the parameters of each effect to adjust the final sound as desired.

For details on the “Program Effects settings”, see step 10.

Using effects in Combinations and Songs

In Combination, and Sequencer modes, you can specify the routing of each timbre/track to the insert effects, master effects and total effect. These settings are made in the same way in each of these modes. We will be using the example of Combination mode in our explanation here.

Routing

1. Access the Combi P8-1: IFX- Routing1 T01-08 page.

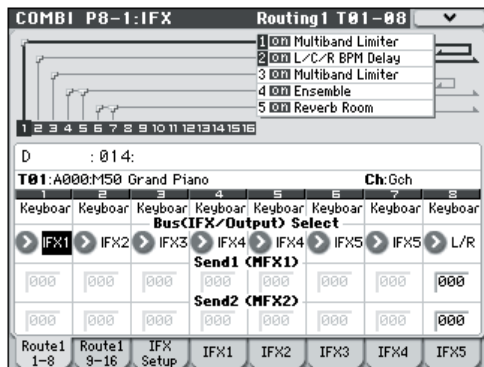

2. Use “Bus (IFX/Output) Select” to specify the bus to which each timbre will be output. Choose IFX1 if you want to send the output of a timbre to insert effect 1.

The routing, insert effects, and chain settings are shown graphically in the upper part of the page. In this example, T01 (timbre 1) uses IFX1 and 2. T02 uses IFX2, T03 uses IFX3 and 4, T02 and T05 use IFX4, and T06 and T07 use IFX5.

3. Use Send1 and Send2 to specify the send level of each timbre to the master effects.

This can be set only if **Bus (IFX/Output) Select** is set to L/R or Off.

Note: The actual send level is determined by multiplying this by the **Send 1** or **Send 2** settings for oscillators 1 and 2 within the program selected by the timbre. If the program parameter **Send 1** or **Send 2** is set to 0, the resulting level will still be 0 even if you raise this send level.

If **Bus (IFX/Output) Select** is set to IFX1-5, the send levels to the master effects are set by **Send1** and **Send2** (Insert FX Setup page) following the insert effects.

4. Access the Combi P8-2: IFX- Routing2 page.

Bus (IFX/Output) Select is the same as in the Routing 1 page. You can set it from either page.

FX Ctrl sends the output of the timbre to an FX Control bus. Use this when you want the audio input to an effect to be controlled by another sound. There are two FX Control buses, which gives you a great deal of freedom for controlling effects freely. For details, please see “FX Control Buses” on page 274 of the Parameter Guide.

Insert effects

5. Access the Combi P8-1: IFX- Insert FX Setup page.

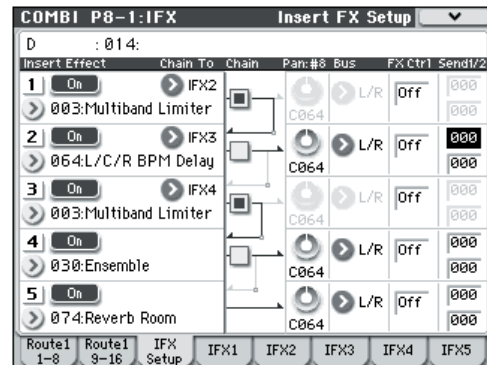

6. Select an insert effect in IFX1-5 and edit the settings.

7. Access the IFX1-5 pages to edit the individual effect parameters.

These settings can be made in the same way as in “Program Effects settings” on page 69.

MIDI You can use MIDI to control dynamic modulation (Dmod) for each effect, the post-IFX pan (CC#8), and Send 1 and Send 2 levels.

An asterisk “*” is shown at the right of Ch01-Ch16 for the channel number of tracks routed to IFX. If you’ve routed multiple tracks that have different MIDI channel settings, this specifies the channel on which they will be controlled.

Master effects and Total effect

These settings can be made in the same way as on page 70.

MIDI You can control these effects via MIDI on the “Ctrl Ch.” The specified MIDI channel will control dynamic modulation (Dmod) for the Master and Total Effect.

Dynamic modulation (Dmod)

Dynamic modulation (Dmod) lets you use MIDI messages or the M50's controllers to modulate specific effect parameters in real-time.

For details, please see “Dynamic modulation (Dmod) and Tempo Synchronization” on page 272 of the Parameter Guide.

Common FX LFO

Two Common FX LFOs are available for modulation effects, such as choruses, filters, phasers, etc. Normally, the phase of the LFOs of multiple modulation-type effects will not be synchronized even if you set them to the identical Frequency, since the LFOs are being generated independently.

However, if you select Common 1 or Common 2 for the **LFO Type** parameter of a modulation-type effect, the effect will use the one of the common LFOs instead of its own individual LFO. This allows you to use a single Common FX LFO to control two or more modulation-type effects such as flanger, phaser, or auto-pan with the same phase. Since you can make independent settings for LFO waveform and phase offset for each effect, you are free to create complex combinations of effects.

Arpeggiator function

Using the arpeggiator while you play

The arpeggiator is a function that automatically generates arpeggios (patterns of individual notes derived from a chord). Most arpeggiators produce an arpeggio when you play a chord on the keyboard.



The chord you played on the keyboard is sounded as an arpeggio (broken chord)

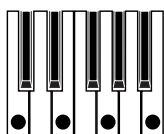

The M50's arpeggiator is also polyphonic, and can produce a variety of chordal transformations or phrases based on the pitch or timing of the notes you play on the keyboard. These functions let you use the arpeggiator to play a wide range of patterns including drum or bass phrases, and guitar or keyboard backing riffs. It is also effective to use the arpeggiator as part of the sound-design process when creating subtly-moving pads, synth-sounds, or sound effects.

The M50's Dual Arpeggiator feature lets you use two simultaneous arpeggio patterns in Combination mode, and Sequencer mode. You can take advantage of this in many ways, including a separate arpeggio pattern for a drum program, and another applied to a bass program, or using a keyboard split or velocity to switch between two arpeggio patterns.

The M50 provides five preset arpeggio patterns: the standard **UP**, **DOWN**, **ALT1**, **ALT2**, and **RANDOM**. You can also create and store 1,028 of your own user patterns. The factory settings contain a wide variety of arpeggio patterns stored in these user locations.

Using the arpeggiator in Program mode

1. Press the **PROG** switch to enter **Program mode**, and select a program. For details, please see “**Selecting Programs**” on page 27.

As you select various programs, you will notice that the ARP ON/OFF switch LED will light for some programs. For details, please see “**Linking the arpeggiator to program, combinations**” on page 77. When you press the keyboard, the arpeggiator will start.

For other programs, you can press the ARP ON/OFF switch (the LED will light) to turn on the arpeggiator. Arpeggios will begin sounding when you play the keyboard.

2. As described in the following sections “**Settings using controllers**” and “**Settings in the display**,” move the controllers or modify the parameters to change the way in which the arpeggios are played.

Settings using controllers

Arpeggiator on/off

- Each time you press the ARP ON/OFF switch, the arpeggiator will be switched on/off.

When the arpeggiator is turned on (the LED will light) and the selected arpeggio pattern will begin when you play the keyboard.

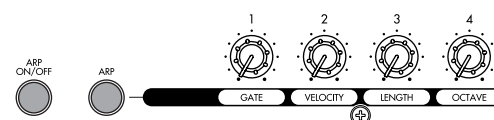

Note: The on/off status is saved when you write each program.

- ▲ In Combination and Song modes, the arpeggios may not start when you press the ARP ON/OFF switch - depending on the saved settings. You may need to play a key, press a chord trigger switch, etc. (see PG page 110).

Adjusting the arpeggiator tempo

- Rotate the TEMPO knob or TAP TEMPO switch to adjust the tempo.

The “♩=” display in the upper right of the LCD will change. The tempo can be adjusted over a range of 40.00–300.00 bpm. The LED will blink in time with the specified tempo.



As an alternative to using the TEMPO knob or TAP TEMPO switch, you can also set the tempo by selecting “♩=” in the display, using the numeric keys 0–9 to enter the tempo, and pressing the ENTER switch. You can also set the tempo by using the VALUE controllers. The LED will blink in synchronization with the tempo you specify.

Note: The tempo setting is also saved when you write a program.

Note: The arpeggio playback speed is affected by the **Reso** setting (Prog P0: Play– Arpeggiator page), or **Resolution** (P7: ARP/DT– ARP Setup page).

- ▲ If the Global P1: MIDI– MIDI Basic page **MIDI Clock** parameter is set to External MIDI, External USB, or set to Auto and MIDI Clock messages are being received, the display will indicate “♩=” EXT, meaning that the M50 is synchronized to an external MIDI device. In this case, you won't be able to change the tempo by operating the M50.

Adjusting the length of the arpeggiated notes

- Press the control surface ARP switch and turn knob 1 to adjust the duration of the arpeggiated notes.

Rotating the knob toward the left will shorten the duration of the notes, and rotating it toward the right will lengthen the duration of the notes. At the center position (12 o'clock), the note length will be as specified by the program parameter: **Gate** (Prog P7: ARP/DT- ARP Setup page).

Note: The knob setting is saved when you write each program.

Note: You can also switch the control surface to RealTime Control A-mode and adjust knob 4 (EG RELEASE) to adjust the length of the arpeggiated notes.

Changing the dynamics of the arpeggiated notes

- Press the control surface ARP switch and turn knob 2 to adjust the dynamics of the arpeggiated notes.

Turning the knob toward the left will make the notes softer, and turning it toward the right will make the notes stronger. When the knob is in the center position (12 o'clock), the value of the program parameter **Velocity** (Prog P7: ARP/DT- ARP Setup page) will be used.

Note: The state of the knob is saved when you write the program.

Note: You can switch the control surface to RealTime Control A-mode and adjust knob 1 (LPF CUTOFF), knob 2 (RESONANCE/HPF), and knob 3 (EG-INTENSITY) to achieve the same effect.

Changing the length of the arpeggio pattern

- Press the control surface ARP switch and turn knob 3 to adjust the length of the arpeggio pattern.

Turning the knob toward the left will shorten the pattern, and turning it toward the right will lengthen the pattern. When the knob is in the center position (12 o'clock), the value of the program parameter **Length** (Global P6: Arpeggio Pattern-Setup page) will be used.

Note: This adjustment is available only if you've selected a user arpeggio pattern U0000(INT)-U1027(USER). If the arpeggio pattern is one of the preset arpeggio patterns P0-P4, turning the knob will not change the length.

Note: The state of the knob is saved when you write the program.

Changing the octave range of the arpeggiated notes

- Press the control surface ARP switch, and turn knob 4 to change the range of octaves in which the arpeggiator will generate notes.

Turning the knob toward the left will narrow the range, and turning it toward the right will broaden the range. When the knob is in the center position (12 o'clock), the value of the program parameter

Octave (Prog P7: ARP/DT- Arp Setup page) will be used.

Note: Depending on the program that's selected, operating knob 4 may not produce any effect.

Note: The knob setting is saved when you write each program.

Settings in the display

- In Prog P0: Play, press the ARP tab.



Selecting an arpeggio pattern

An arpeggio pattern can be selected from preset arpeggio patterns P0-P4 and user arpeggio patterns U0000(INT)-U1027(USER). The factory settings U0000(INT)-U0899(INT), U0900(USER)-U1027(USER) contain a wide variety of preloaded user arpeggio patterns.

- Choose **Pat (Pattern Select)**, and use the VALUE slider, VALUE dial, Δ ∇ switches, and popup menu to select an arpeggio pattern.

User arpeggio patterns can also be selected by using the numeric keys 0-9 to input the pattern number and then pressing the ENTER switch.

P0: UP



P1: DOWN



P2: ALT1

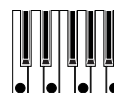

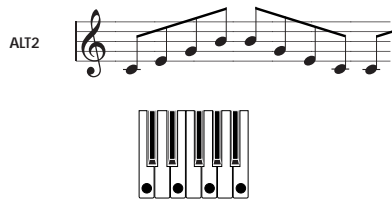
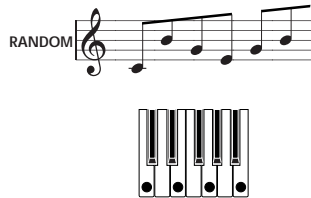
P3: ALT2**P4: RANDOM****Changing the note value of the arpeggiated notes**

The **Reso (Resolution)** parameter lets you set the note value of the arpeggiated notes, over a range from ♪_3 - ♪ .

- Press “Reso,” and use the VALUE slider, VALUE dial, Δ ∇ switches, or popup menu to select the desired arpeggio note value.

Selecting the octave range in which the arpeggio is sounded

Use the “Octave” radio buttons to specify the range of octaves in which the arpeggio will play.

- Press an “Octave” radio button to make your selection.

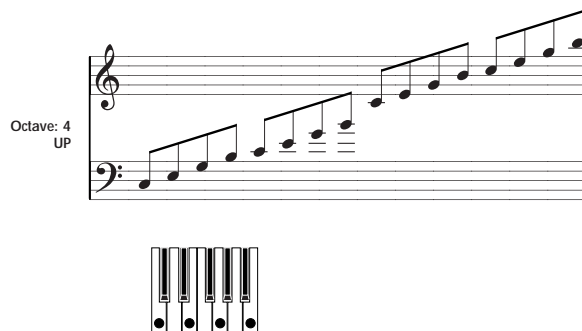
**Sounding an arpeggio in the order of the pitches in the chord you played**

You can select whether the notes of the arpeggio will be sounded in the order of the pitches in the chord you played (regardless of the order in which you actually played the notes), or in the order in which you played the notes.

- Press the “Sort” check box in the display to make this setting.

Checked: the arpeggio will play each note in the order of its pitch, regardless of the order in which you actually played the notes.

Unchecked: the arpeggio will trigger each note in the order in which you actually played the notes.

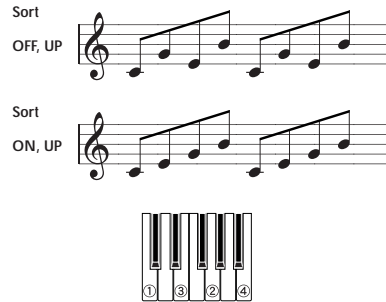
**Setting the arpeggio to continue playing even after you have taken your hand off the keyboard**

You can select whether the arpeggio will continue playing when you take your hand off the keyboard, or whether the arpeggio will stop.

- Press the “Latch” check box to make this setting.

Checked: The arpeggio will continue playing even after you remove your hand from the keyboard.

Unchecked: The arpeggio will stop playing when you remove your hand from the keyboard.

Synchronizing the arpeggiator to your keyboard timing

You can specify whether the arpeggio will begin at the moment you play the keyboard, or whether it will always play in synchronization to the MIDI clock tempo.

- Press the “Key Sync.” check box to make this setting.

Checked: The arpeggio pattern will start from the beginning when you press a key. This setting is suitable when you want the arpeggio to start from the beginning of the measure as you are playing in real-time.

Unchecked: The arpeggiator will synchronize to the MIDI clock timing.

Sounding both the arpeggio notes and the notes you play

- Press the “Keyboard” check box to make this setting.

Checked: The notes you play on the keyboard and the notes played by the arpeggiator will both be heard.

Unchecked: Only the arpeggiated notes will sound.

Using the arpeggiator in Combination mode

In Combination mode the M50 provides dual arpeggiators, allowing you to run two arpeggio patterns simultaneously.

1. Press the COMBI switch to enter Combination mode, and select a combination. For details, please see “Selecting Combinations” on page 43.

As you select various combinations, you will notice that the ARP ON/OFF switch LED will light for some combinations. For details, please see “Linking the arpeggiator to program, combinations” on page 77. When you press the keyboard, the arpeggiator will start.

For other combinations, you can press the ARP ON/OFF switch (the LED will light) to turn on the arpeggiator.

2. As described in the preceding section “Settings using controllers” and the following section “Settings in the display,” move the controllers or modify the parameters to change the way in which the arpeggios are played.

▲ The ARP ON/OFF switch, TEMPO knob, TAP TEMPO switch, and control surface ARP will apply to both arpeggiators A and B. Their state is saved when the combination is written.

Settings in the display

- In Combi P0: Play, press the ARP A tab.



Select the arpeggiator(s) that will run

Use the **Arpeggiator Run** check boxes to specify the arpeggiator(s) that you want to have running. The arpeggiator(s) that are checked here will operate when the ARP ON/OFF switch is on. However, the arpeggiator will only play a timbre if the table next to the check boxes assigns arpeggiator A or B to a timbre: T 1-16. You make these settings in Combi P7: ARP/DT- ARP Setup T01-08, T09-16 page **Arpeggiator Assign** (see PG page 107).

Arpeggiator-A, Arpeggiator-B

For each arpeggiator A and B, you can make settings for **Pat (Pattern Select)**, **Reso (Resolution)**, **Octave**, **Sort**, **Latch**, **Key Sync**, and **Keyboard**. (see PG page 108)

Checking the structure of a user arpeggio pattern

Let's see how the combination “C015: Skippy Wants to Dance!” (category: LeadSplits) is constructed.

- Select combination “C015: Skippy Wants to Dance!” (category: LeadSplits), and look at the Arpeggio Play A page and Arpeggio Play B page.



- As you can see from the “Timbre Assign” table, arpeggiator A is assigned to timbre 3, and arpeggiator B is assigned to timbre 5 and 8.

When you play the keyboard the arpeggiator B will play the program assigned to timbre 5 (Timbre 8 is a dummy timbre used to operate Timbre 5) (see PG page 110). Arpeggiator A will play the program assigned to timbre 3.

- If you uncheck **Arpeggiator Run A** or **Arpeggiator Run B**, it will stop.

If you check it once again and play the keyboard, that arpeggiator will begin running.

- Look at the Combi P7: ARP/DT- ARP Scan Zone page, and you will see that the A keys **Top Key** and **Bottom Key** are set so that arpeggiator A will operate only for keys B3 and lower, and that the B **Top Key** and **Bottom Key** are set so that arpeggiator B will operate only for keys C4 and higher.

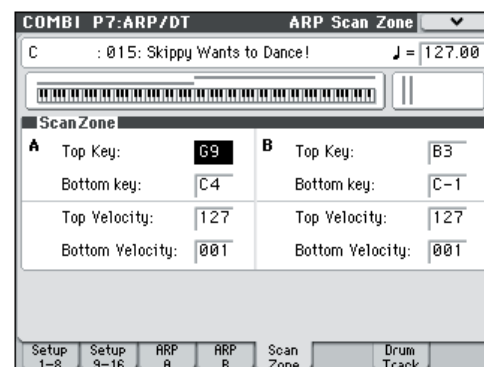

Other settings for the arpeggiator

You can also set **Gate**, **Velocity**, **Swing**, and **Scan Zone**. These parameters are set in Prog P7: ARP/DT- ARP Setup page, Combi P7: ARP/DT- Arpeggiator A, B page (see PG page 59, page 107 and page 168).

Linking the arpeggiator to program, combinations

You can specify whether the arpeggiator settings written in a program or combination will change when you switch programs or combinations, or whether the arpeggiator status will not change when you switch programs or combinations.

With the factory settings, the former is selected. Use the latter when you want to keep the same arpeggio pattern running, and change only the program sound.

This setting is made in "Load ARP when changing" (Global P0: Basic Setup, Basic page). (See PG page 217)

Arpeggiator synchronization

For details on synchronization between arpeggiators A and B, synchronization with the drum track function, and synchronization between the arpeggiators and sequencer in Sequencer mode, please see PG page 174.

Creating a user arpeggio pattern

Arpeggio patterns that you create can be written to U0000(INT)-U1027(USER).

These can be created in Global P6: Arpeggio Pattern. (See PG page 246)

Drum Track function

Performing with the Drum Track function

The Drum Track function makes it easy to play the M50's high-quality drum programs using a wide variety of Drum Track patterns.

It provides a convenient way for you to hear Drum Track patterns while you try out various phrases on a program or combination, or work out the outline of your song. Then, when you've come up with some ideas, you can use the Auto Song Setup function to immediately start recording in Sequencer mode.

You can use preset drum patterns that cover a wide range of musical styles, as well as user patterns that you yourself created.

Preset	P001...P671	Preset Drum Track patterns
User	U000...U999	User Drum Track patterns

You can write your own patterns into U000–U999. User patterns you've created in Sequencer mode can be converted into user Drum Track patterns.

The Drum Track pattern will start immediately when you press the DRUM TRACK ON/OFF switch, or when you play the keyboard after pressing the ON/OFF switch. If you're starting the pattern by playing the keyboard, you have the option of starting it by using a specific range of notes or velocities.

The sound of the Drum Track program can be adjusted using the drum track EQ, and you can also easily change the effect routing settings.

Using the Drum Track function in Program mode

Selecting a program and turning the Drum Track function on/off

1. Press the MODE PROG switch to enter Program mode, and select the desired program. For details, please see "Selecting Programs" on page 27.

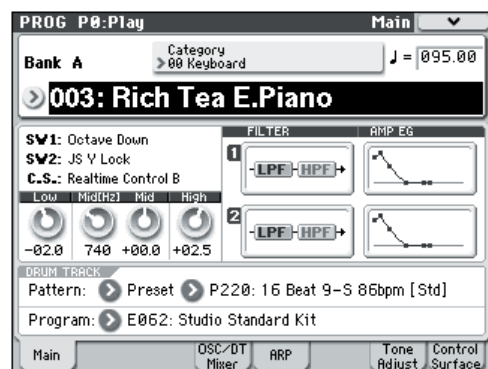

2. Press the DRUM TRACK ON/OFF switch.

The ON/OFF switch will light or blink, depending on the setting (**Trigger Mode**) of the program.

If lit: The Drum Track pattern will start according to the **Sync** setting. When you turn it off, the pattern will stop. (This will occur if the **Trigger Mode** parameter is set to Start Immediately.)

If blinking: The Drum Track pattern will be ready to start. It will start when you play the keyboard or when a MIDI note-on is received. (This will occur if the **Trigger Mode** parameter is set to Wait KBD.)

Adjusting the performance tempo

1. You can use the TEMPO knob or the TAP TEMPO switch to adjust the performance tempo.

This will change the "♩=" value located in the upper right of the display. You can adjust the tempo with a range of 40.00–300.00 bpm. The LED located above the TAP TEMPO switch will blink at intervals of a quarter note (♩).

You can also adjust the tempo by choosing "♩=" in the display. Use numeric keys 0–9 to enter the tempo, and then press the ENTER switch. You can also use the VALUE controller to set the tempo. The LED will blink at the tempo you specify.

Note: The tempo setting is also saved when you write a program.

 If the Global P1: MIDI- MIDI Basic page **MIDI Clock** parameter is set to External MIDI, External USB, or set to Auto and MIDI Clock messages are being received, the display will indicate "♩=" EXT,



and the M50 will be synchronized to an external MIDI device. In this case, you won't be able to change the tempo by operating the M50.

Selecting a Drum Track pattern and Drum Track program

1. Access the Prog P0: Play- Main page.



2. Select a Drum Track pattern. Use "Pattern Bank" to select the preset or the user bank, and use "Pattern No." to select the pattern number.
3. Use "Drum Track Program" to select the program that will play the Drum Track pattern.

Note: You can only select programs of category number 15 (Drums). If you want to use an original program you created as the Drum Track program, save it with "Category" set to 15 (see page 33).

Note: If you've selected an empty pattern, the DRUM TRACK ON/OFF switch will not function.

These parameters can also be set from P7: ARP/DT page.

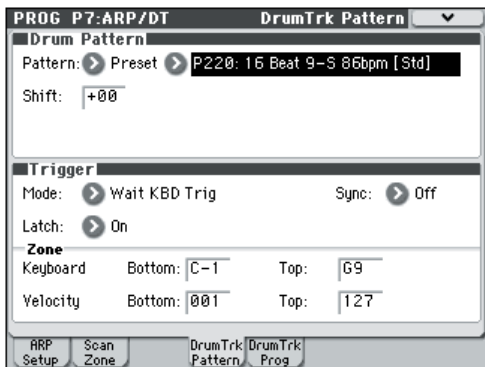

Using the Drum Track function in Combination mode

Selecting a combination and turning the Drum Track function on/off

1. Press the MODE COMBI switch to enter Combination mode, and select the desired combination. For details, please see "Selecting Combinations" on page 43.

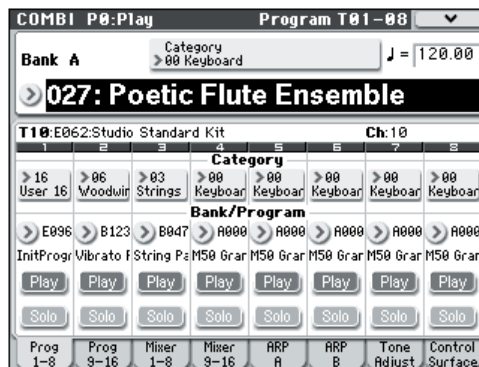

2. Press the DRUM TRACK ON/OFF switch.

The ON/OFF switch will light or blink, depending on the setting (**Trigger Mode**) of the combination.

If lit: The Drum Track pattern will start according to the **Sync** setting. When you turn it off, the pattern will stop. (This will occur if the **Trigger Mode** parameter is set to Start Immediately.)

If blinking: The Drum Track pattern will be ready to start. It will start when you play the keyboard or when a MIDI note-on is received. (This will occur if the **Trigger Mode** is set to Wait KBD.)

Adjusting the performance tempo

You can use the TEMPO knob or the TAP TEMPO switch to adjust the performance tempo.

Selecting a Drum Track pattern and Drum Track program

Unlike its operation in Program mode, the Drum Track function in Combination mode does not have its own dedicated track (timbre). The program that plays the Drum Track pattern will use the timbre you specify.

1. In the Combi P0: Play- Program T01-08 page or T09-16 page, select the timbre that you want to use for the drum track, and then select the Drum Track program.

In the following illustration, we've selected timbre 10 for use by the drum track.

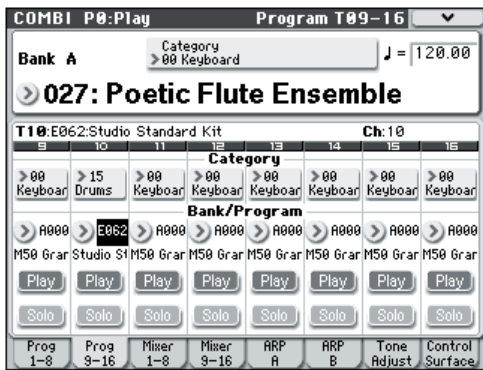

2. Specify the MIDI channel of the drum track timbre.

Be aware that if another timbre uses the same MIDI channel, that timbre will also be played.

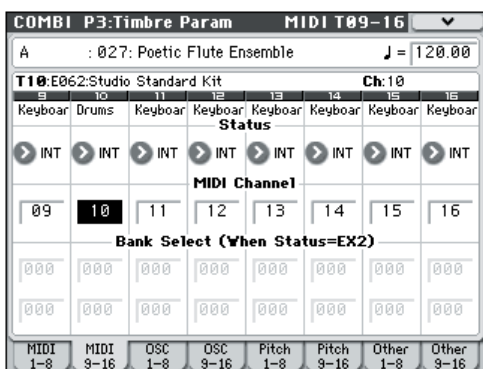

3. Access the Combi P7: ARP/DT- Drum Track page.

Specify the drum track's MIDI channel **Output**. Set this to match the **MIDI Channel** of the timbre you specified in step 2.

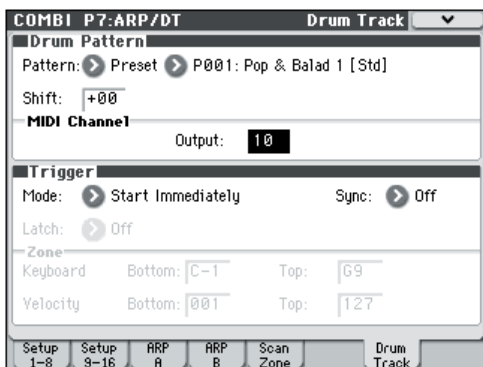

4. Select a Drum Track pattern. Use “Pattern (Pattern Bank)” to select the preset or user bank, and use “Pattern No.” to select the pattern number.

Note: If you select an empty pattern, the DRUM TRACK ON/OFF switch will not function.

5. Press the DRUM TRACK ON/OFF switch to verify that the pattern plays correctly.

The method of triggering will depend on the Trigger settings. If the **Trigger Mode** parameter is set to Start Immediately, the Drum Track pattern will start when you press the ON/OFF switch. For details on the Trigger settings, please see “7-4b: Trigger” on page 62 of the Parameter Guide.

Other settings for the drum track

Settings for the drum track include **Sync**, **Latch**, and **Zone**. You can edit these parameters in the Prog P7: ARP/DT- Drum Trk Pattern page, and in the Combi P7: ARP/DT- Drum Track page.

For details, please see PG page 62, page 111, and page 172.

Drum track synchronization

For details on synchronization between the drum track and the arpeggiators, the songs and patterns in Sequencer mode, and RPPR playback, please see PG page 173.

Creating drum track patterns

A drum pattern you've created can be converted into a drum track pattern (see PG page 208).

Settings for the entire M50

How Global mode is structured

In Global mode, you can make settings that apply to the entire M50, such as master tuning, key transpose, effect global switch, and global MIDI channel.

In addition, you can create user drum kits, user arpeggio patterns, and scales, make settings for the damper pedal and assignable foot switches/pedals, and specify category names for programs and combinations.

For details on each mode and how to access each page, please see “Basic operations” on page 16.

 The edits you perform in Global mode will not be preserved after the power is turned off unless you first save your settings. Three types of data are handled in Global mode: user drum kit settings (Global P5), user arpeggio patterns (Global P6), and all other global settings (Global P0–4). Each of these has a respective memory area to store its data. This data can also be saved to various types of SD card in Media mode.

For details, please see “Writing Global settings, User Drum Kits and User Arpeggio Patterns” on page 89, “Saving to media (Media-Save)” on page 91.

 The Compare function that lets you return to the state prior to your editing (or undo edits) is not available in Global mode.

For details, please see “Key Transpose” on page 216 of the Parameter Guide.

Adjusting the way in which velocity or after-touch will affect the volume or tone

You can specify the degree to which the volume or tone will be affected by a note’s velocity or by messages such as aftertouch received from MIDI IN.

For details, please see “Velocity Curve” on page 216 of the Parameter Guide.

For details, please see “Aftertouch Curve (MIDI IN)” on page 217 of the Parameter Guide.

Bypassing the effects

You can bypass insert effects, master effects, and total effect globally.

For details, please see “0–1b: Effect Global SW” on page 217 of the Parameter Guide.

Linking the arpeggiator to Programs and Combinations

You can specify whether the arpeggiator settings associated with a Program or Combination will also be selected when you select that program or combination, or whether the arpeggiator settings you choose will be retained when you switch the Program or Combination.

For details, please see “Load ARP when changing:” on page 217 of the Parameter Guide.

Global settings

Basic setup

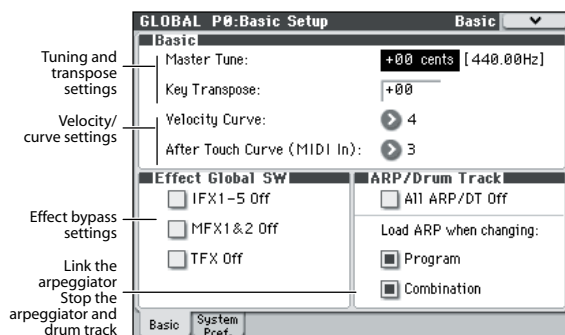

Tuning to another instrument/Transposing

Master Tune adjusts the overall pitch.

Key Transpose shifts the pitch in semitone steps.

For details, please see “Master Tune” on page 216 of the Parameter Guide.

Stopping the arpeggiator and drum track

If you select the **All ARP/DT Off** box, all arpeggiators and the drum track function will be turned off, even if the ARP ON/OFF and DRUM TRACK ON/OFF switches are on.

For details, please see “All ARP/DT Off” on page 217 of the Parameter Guide.

System preference

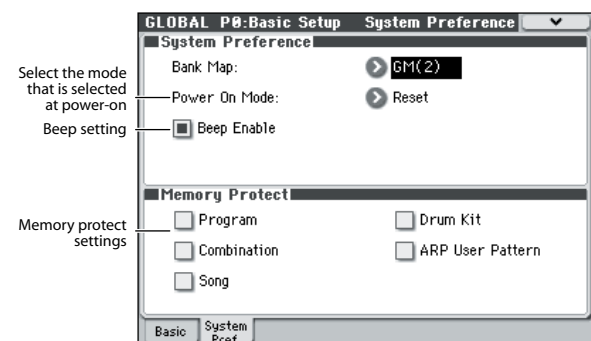

Recalling the last-selected mode and page at power-on

The state of M50 when the power is turned on will depend on the setting of the **Power On Mode**.

If the **Power On Mode** is set to Reset (factory setting), M50 will automatically select the Program mode P0: Play.

If the **Power On Mode** is set to Memorize, the location (mode and page) and the program or combination number that had been selected when you turned off the power will be recalled.

For details, please see “Power On Mode” on page 218 of the Parameter Guide.

Sounding a beep when you press the display

For details, please see “Beep Enable” on page 218 of the Parameter Guide.

Protecting the memory

For details, please see “Memory protect” on page 90, and “0-2b: Memory Protect” on page 219 of the Parameter Guide.

MIDI Basic/Routing

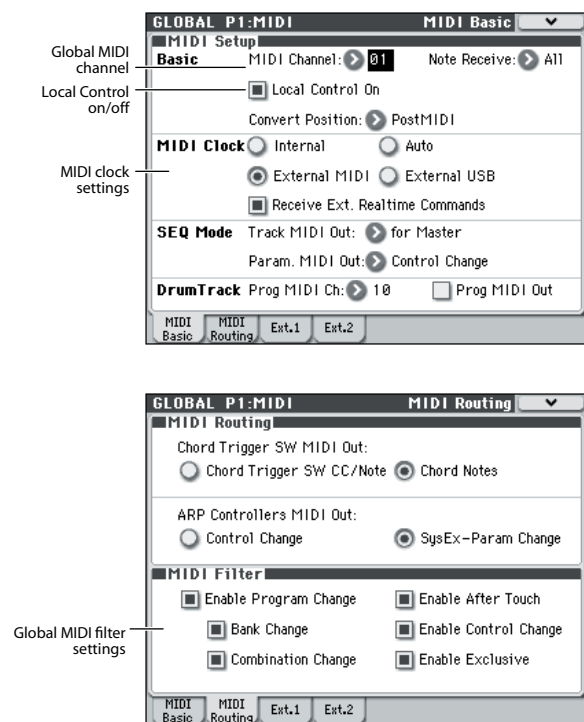

MIDI-related settings for the entire M50

In the Global P1: MIDI- MIDI Basic page and the MIDI Routing page, you can make settings for the global MIDI channel, the Local Control on/off setting, MIDI clock, MIDI routing, and MIDI filtering.

You can also use a menu command in this page to transmit MIDI exclusive data dumps.

For details, please see “Dump:” on page 253 of the Parameter Guide.

Pedal and other controller settings

In the Global P2: Controllers- Foot Controllers page you can make the following settings.

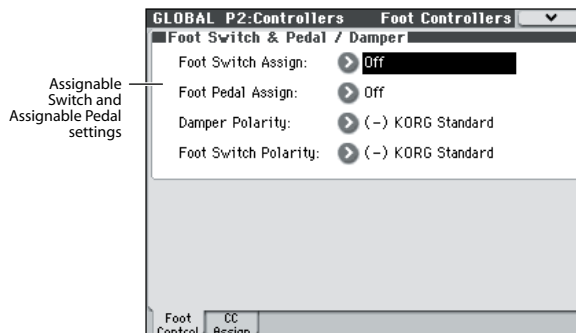

Specifying the function of the Assignable Switch and Assignable Pedal

For details, please see “2-1: Foot Controllers” on page 228 of the Parameter Guide.

Setting Category Names

The Category Name pages let you assign names to the Program and Combination categories, and sub-categories.

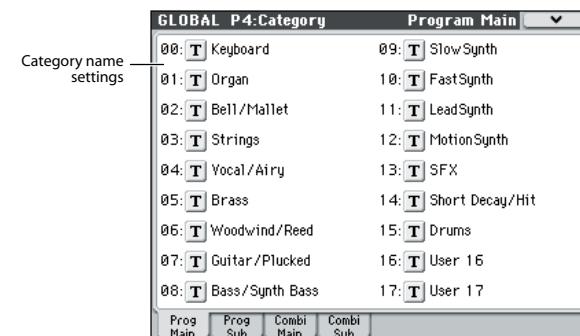

Setting Category Names for Programs and Combinations

For details, please see “Global P4: Category” on page 232 of the Parameter Guide.

External control

To use the M50 to control external MIDI devices, press the control surface EXTERNAL switch. You can then use knobs 1–4 and the chord trigger switches to transmit MIDI control changes to external MIDI devices. You can create, save and recall a total of 128 such external setups.

Various preloaded external setups are provided as factory settings. For instance, some external setups let you control software synthesizers such as those in the Korg Legacy Collection. Other external setups let you control level and pan settings of your DAW software in real time.

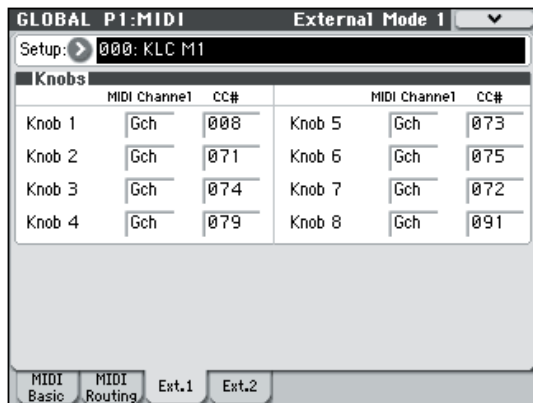

You'll use the Global P1: MIDI– External Mode page to create external setups. For details on use and some examples, please see “1–3: External Mode 1” on page 224 of the Parameter Guide.

Note: See the “M50 External Setups” (PDF) for details on the control change (CC#) settings assigned to the preloaded external control templates and their corresponding application settings.

Using Drum Kits

What's a Drum Kit?

A drum kit is a collection of drumsamples (samples comprising a kit element) assigned to each key. Drum kits have the following features.

- A different sound will play for each note.
- A drumsample (one drum instrument) is assigned to each key.
- You can assign up to four drum samples to each note, and use velocity crossfading to switch between them.
- Each note has individual settings for the most important sound parameters, including volume, filter cutoff and resonance, attack and decay, pitch, drive and low boost, and gain for each band of the Program EQ.

For instance, you could combine high drive and low cutoff frequency to create a lo-fi effect on a few sounds, while the rest of the sounds remained clear and pristine.

- Each note can be independently routed to a different Insert Effect, or have separate FX Send amounts. For instance, you can send a snare sound through a dedicated compressor.

You can use Drum Kits only in Programs whose **Oscillator Mode** is set to **Drums**.

For details, please see “Creating a Drum Kit” on page 240 of the Parameter Guide.

Loading & saving data

Saving data

Types of data that can be saved

You can save the various types of data in the M50 by writing it to internal memory, by saving it to an SD card (commercially available), or by sending it as a MIDI data dump.

Writing to internal memory

The following types of data can be written into the internal memory.

- **Program**
Programs 000–127 in banks A–E
 - **Combination**
Combinations 000–127 in banks A–D
 - **Global settings**
(Global P0: Basic Setup–P4: Category)
 - **User drum kits**
00(INT)–47(USER)
 - **User arpeggio patterns**
U0000(INT)–U1027(USER)
 - **User Drum Track patterns**
U000–U999
(See page 79)
 - **User template songs U00–U15**
Song settings such as the song name and tempo, track settings (see PG page 126), arpeggiator, and effect settings can be saved (written) to internal memory. However, the musical data for song tracks and patterns are not saved to internal memory. Furthermore, settings that govern how the musical data is played back such as **Meter**, **Metronome**, **PLAY/MUTE**, **Track Play Loop** (including Start/End measure), and RPPR settings will not be saved either. Use the Sequencer mode menu command **Save Template Song** to write this data; for details, please see “Save Template Song (Save as User Template Song)” on page 192 of the Parameter Guide.
 - **Effect presets**
For each effect, you can write parameter settings into internal memory by using the menu command **Write FX Preset**.
-  Data that you edit in Sequencer mode can only be saved to media; it cannot be saved in internal memory.

About preloaded data and preset data

“Preloaded data” refers to the data that is loaded in the M50 when it is shipped from the factory. You are free to rewrite this data, and with the exception of the demo songs, the data will be written to the location as described in “Writing to internal memory.” This data is stored in the M50’s system area.

You can reload the factory preload data into internal memory by using the Global mode menu command **Load Preload/Demo Data**.

Preset data, on the other hand, is data that cannot be overwritten by the Write operation. This includes the following data.

- GM program banks GM, g(1)–g(9), g(d)
- GM drum kits 144(GM)–152(GM)
- Preset template songs P00–P15
- Preset patterns P000–P671

Saving to media

The following data can be saved to various types of media.

- **.PCG file:**
Programs, Combinations, Drum kits, Global settings, user Drum Track patterns, and user arpeggio patterns (The data that was checked in the check boxes of the Save dialog box will be saved.)
- **.SNG file:**
Song and cue list.
- **.EXL file:**
System exclusive data from an external device that was saved on the M50 (This allows the M50 to be used as a data filer.)
- **.MID file:**
Saves a Sequencer mode song in Standard MIDI File (SMF) format.

MIDI data dump

The M50 can transmit the following types of data as a MIDI data dump; you can save this data on an external data filer or other device.

- Programs, combinations, drum kits, and global settings
- Song and cue list
- User drum kit patterns
- User arpeggio pattern

For details, please see “Dump:” on page 253 of the Parameter Guide.

Writing to internal memory

Writing a Program or Combination

The Program and Combination settings you've made in the various editing pages can be saved to internal memory. This action is referred to as "writing a program" or "writing a Combination." If you want your edited data to be preserved after the power is turned off, you must perform a Write operation.

There are two ways to write a Program or Combination.

- ⚡ Before you can write data into memory, you must turn off the memory protect setting in Global mode. For details, please see "Memory protect" on page 90.
- ⚡ A combination does not contain the actual program data for each timbre, but simply references the number of the program used by each timbre. If you edit a program that is used by a combination, or exchange it with a different program number, the sound of the combination will also change, reflecting the altered program.

Using the Write menu command

1. Verify that the program or combination you want to save is selected.
2. Select the menu command "Write Program" or "Write Combination."

The Write Program or Write Combination dialog box will appear.

Note: You can also access the same dialog box by holding down the ENTER switch and pressing the 0 switch. For details, please see "Shortcuts" on page 405 of the Parameter Guide.

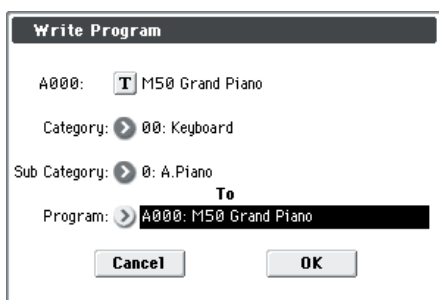

This screenshot is for Program mode

3. Check the program/combination name displayed in the upper line (the writing source).
4. If you wish to change the name of the program/combination, press the text edit button.

The text dialog box will appear. Enter the name of the program/combination. For details, please see "Editing names" on page 91.

After you have entered the name, press the OK button to return to the Write Program/Write Combination dialog box.

5. In "Category," specify the category of the Program/Combination.
6. Select a "Sub Category" as well.

For combinations, the category and sub-category you specify here can be selected in the following pages.

Prog P0: Play
"Category"

Combi P0: Play- Program T01-08, 09-16
"Category"

Seq P0-1: Play/REC- Program T01-08, 09-16
"Category"

For Programs, the category/sub-category you specify here can be selected in the following pages.

Combi P0: Play- Program T01-08, 09-16
"Category"

7. Use "To" to specify the bank and number of the writing destination program/combination.

Use the VALUE controllers or the BANK switches to make your selection.

8. To execute the Write operation, press the OK button. To cancel without executing press the Cancel button.

When you press the OK button, the display will ask "Are you sure?" When you press the OK button once again, the data will be written.

You can also use the ENTER switch instead of the OK button to confirm the Write operation, or use the EXIT switch to Cancel the Write operation.

Using the (SEQUENCER) REC/WRITE switch to write

This method can only be used to write the selected program/combination number.

1. Press the SEQUENCER REC/WRITE switch.

The following Update Program/Update Combination dialog box will appear.

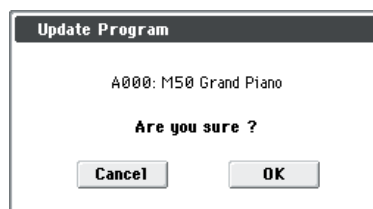

This screenshot is for Program mode

2. To write the data, press the OK button. To cancel without writing, press the Cancel button.

You can also use the ENTER switch instead of the OK button to confirm the Write operation, or use the EXIT switch to Cancel the Write operation.

About the Tone Adjust settings that are saved

There are three types of Tone Adjust parameters, as listed below. The way in which settings are written will depend on the type.

- **Absolute:** This type of Tone Adjust parameter controls a single program parameter. The Program parameter and the Tone Adjust parameter reflect each other exactly. If you edit one, the other parameter will reflect the identical change. This type of Tone Adjust parameter "absolutely" controls the program parameter itself.

- **Relative:** This type of Tone Adjust parameter controls two or more program parameters simultaneously. For example, “Filter/Amp EG Attack Time” controls a total of six program parameters. The value of a relative parameter indicates the amount of change that is applied to the value of each program parameter it’s affecting. When a relative parameter is at zero (i.e., when its slider is in the center position), the program parameters it controls will function according to their original settings. Raising or lowering the value of a relative parameter will indirectly raise or lower the value of these program parameters.
- **Meta:** This type of Tone Adjust parameter affects other Tone Adjust parameters. It does not affect program parameters directly.

If you’ve adjusted an absolute or a relative Tone Adjust parameter, the result of your adjustment will be written as follows.

Program mode:

- The settings of relative-type Tone Adjust parameters are automatically applied directly to the program parameters when you write the program. The Tone Adjust values will be reset to zero.
- The settings of absolute-type Tone Adjust parameters are written “as themselves” (i.e., as the new settings of those Tone Adjust parameters).

Combination mode:

- The settings of both relative-type and absolute-type Tone Adjust parameters are written and preserved as the Tone Adjust settings for each timbre.

For details, please see “0–7: Tone Adjust” on page 6, page 85 of the Parameter Guide.

About the Program and Combination edit buffer

When you select a program in Prog P0: Play or a combination in Combi P0: Play, the program or combination data is called into the M50’s edit buffer.

When you then use the various Program or Combination pages to edit the parameters, your changes will affect the data in the edit buffer.

If you wish to save this modified data into internal memory, you must perform the Write operation.

When you perform the Write operation, the data in the edit buffer is written to the specified program or combination number of the specified bank.

If you select another program or combination without writing your edits, the data of the newly selected program or combination will overwrite the edited data in the edit buffer, and your changes will be lost.

Note: When you press the COMPARE switch in Program mode, or Combination mode, the data from memory (i.e., the contents that were written into memory) will be temporarily called into the edit buffer. This allows you to compare the settings you are editing with the original un-edited settings.

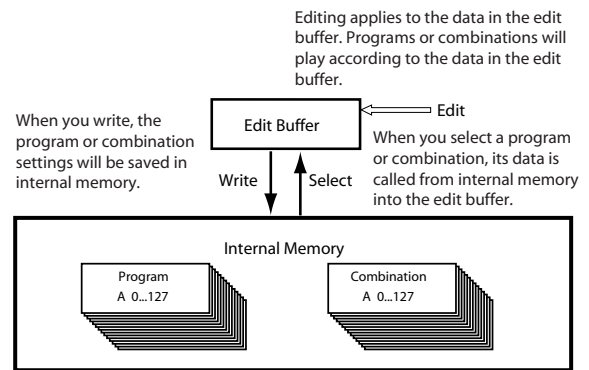

Writing Global settings, User Drum Kits and User Arpeggio Patterns

The settings you edit in Global mode can be written into internal memory. This is done using the operations Write Global Setting, Write User Drum Kits, and User Arpeggio Patterns. If you wish to keep these edited settings after you turn the power off, be sure to write the data first.

There are two ways to write global settings: User Drum Kits and User Arpeggio Pattern.

Using a menu command to write

1. To write global settings (the various settings in Global P0–P4), press the menu command “Write Global Setting” in Global P0–P4.

Note: Alternatively, you can access the same dialog box by holding down the ENTER switch and pressing the 0 switch. For details, please see “Shortcuts” on page 405 of the Parameter Guide.

The Write Global Setting dialog box will appear.



⚠ The Effect Global SW setting is not saved.

To write the Drum Kits (the settings of Global P0–P4), choose the menu command Write Drum Kits in Global P5.

The Write Drum Kits dialog box will appear.

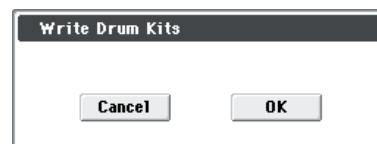

To write the User Arpeggio Patterns (the setting of Global P6), choose the menu command Write Arpeggio Pattern in Global P6.

The Write Arpeggio Pattern dialog box will appear.



2. To write the data, press the OK button. If you decide not to write, press the Cancel button.

When you press the OK button, the display will ask “Are you sure?” Press the OK button once again to write the data.

Using the (SEQUENCER) REC/WRITE switch to write

1. In the following pages of Global mode, press the SEQUENCER REC/WRITE switch.

One of the following dialog boxes will appear according to the page.

P0–P4: Update Global Setting

P5: Update Drum Kits

P6: Update Arpeggio Patterns

2. To write the data, press the OK button. If you decide not to write, press the Cancel button.

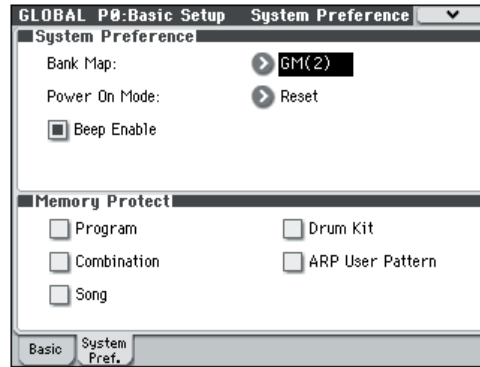

3. Press the “Memory Protect” check box for the type of data you wish to write to internal memory, so that the box is unchecked.

Memory in Global mode

When the power is turned on, the Global mode data is called from internal memory into the Global mode memory area. Then when you modify the parameters in Global mode, the data in the memory area will be modified. If you wish to save this modified data in internal memory, you must Write it.

When you write this data, the data in the memory area is written into the global settings.

If you turn off the power without writing, the modified data in the memory area will be lost.

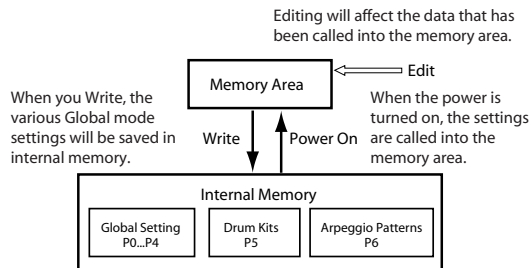

Memory protect

To prevent Programs, Combinations, Songs, Drum Kits, and User Arpeggio Patterns from being overwritten accidentally, the M50 provides a Memory Protect setting that prohibits writing to memory.

Before you save edited data or load data from media, use the following procedure to turn the memory protect off (uncheck the appropriate check box).

You must also turn memory protect off before loading the above data from media or via a MIDI data dump, or before recording in Sequencer mode.

1. Press the MODE GLOBAL switch to enter Global mode.

2. Access the Global P0: Basic Setup– Basic page.

Editing names

You can modify the name of an edited program, combination, song, drum kit, or user arpeggio patterns etc.

You can also modify the category names for programs and combinations.

These renaming operations can be performed in the following pages.

Item	Page
Program	Prog P0...9 menu command: Write Program
Combination	Combi P0...9 menu command: Write Combination
Song	Seq P0...5 menu command: Rename Song
Track	Seq P6: Track Name
Pattern	Seq P10: Pattern Name
Cue list	Seq P11: menu command: Cue List
Program category/ sub category	Global P4: Program Category
Combination category/ sub category	Global P4: Combination Category
Drum Kit	Global P5 menu command: Rename Drum Kit
Arpeggio Pattern	Global P6 menu command: Rename Arpeggio Pattern
File	Media Save: Save All... Save Exclusive, Media Utility menu command: Rename, Create Directory, Format
Effect preset	Prog, Combi, Seq P8, 9 menu command: Write FX Preset

1. In the pages listed above, or after selecting a menu command in these pages, press the text edit button **T** to access the text edit dialog box.

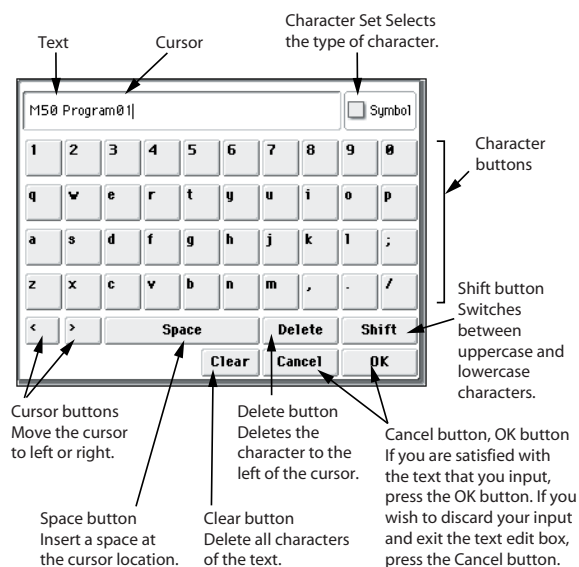

Saving to media (Media-Save)

For details on the data that can be saved on storage media. For details, please see "Types of data that can be saved" on page 87.

- ⚠ Song data in the M50's Sequencer mode, as well as multisamples and samples cannot be written into internal memory. This data will disappear when the power is turned off. In order to keep this data, you must write it to the SD card (commercially available). When you've come up with settings you like, it's a good idea to save them, so that even if you subsequently edit those settings, you'll always be able to reload the previous settings if desired.

Types of media you can use

SD card specifications

MS-DOS format FAT16 or FAT32 are supported.

Capacity recognized: FAT32: 2 Gigabytes (GB)

- ⚠ **SDHC memory cards are not supported.**

- ⚠ Media is not included. You will need to purchase it separately.

Inserting/removing a card in the SD card slot

If you've placed an SD card in the SD card slot, you can use it to save or load various types of Program, Combination, and Song data.

Inserting a card

- Insert an SD card in the SD card slot.

With the card label facing upward, insert the connector end of the card into the SD card slot and press it in until you hear a click.

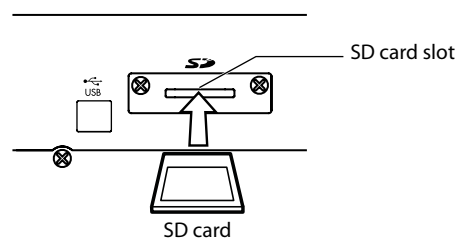

- ⚠ Make sure that the card is oriented correctly when you insert it. Forcing it in the wrong direction may damage the slot or the card, and the data may be lost.

Removing a card

- ⚠ Never remove an SD card from the slot while loading, saving, or formatting is in progress.

- Remove the card from the SD card slot.

Press the card inward; you will hear a click, and the card will pop out part-way, allowing you to pull it completely out.

Refer to the owner's manual included with your card, and observe the guidelines for handling and use.

How to save data

Access the Media- Save page, and select the appropriate menu command according to the data that you're saving to media.

For details on saving, please see "0-2: Save" on page 260 of the Parameter Guide.

Cautions when saving

If an identically named file exists on the media

If a file with the same name already exists on the media, you will be asked whether you want to overwrite. If you wish to overwrite, press the OK button. If you want to save without overwriting, press the Cancel button and rename the file before you save it. For details, please see "Editing names" on page 91.

Please note when saving

- When using **Save All (PCG & SNG)**, and **Save PCG** to save combinations, you should also remember to save the programs used by each timbre (or the drum kits, and user arpeggio patterns used by the programs) at the same time. Similarly when saving programs, you should also remember to save the drum kits, user drum track patterns and user arpeggio patterns used by the programs.

Time required when saving data

- The length of time required will depend on the amount of data being saved.

Using the M50 as a data filer

The M50 can receive MIDI System Exclusive data sent by an external device, and save this data to media. (This is sometimes referred to as the "Data Filer" function.) For details, please see "Save Exclusive" on page 268 of the Parameter Guide.

Loading data

Data that can be loaded

Loading from media

You can load the following data from media.

- **.PCG file:**
Programs, Combinations, Drum Kits, Global settings, User Arpeggio Patterns, and User Drum Track patterns
- **.SNG file:**
Song and cue list.
- **.MID file:**
Standard MIDI file (SMF) format
- **.EXL file:**
MIDI exclusive data

Loading the preloaded data and demo songs to restore the factory settings

You can load the factory settings and demo songs back into the M50's internal memory. For the procedure, please see "Loading the preloaded data" on page 97.

- **Preload data:**
Programs, Combinations, Drum Kits, Global settings, User Arpeggio Patterns
- **Demo song data**

Loading data from media (Media-Load)

Loading all Programs, Combinations, Drum Kits and Arpeggio patterns

Here we'll explain how to load all data from a .PCG file containing Programs, Combinations, Drum kits, Global settings, User Arpeggio patterns, and Drum Track patterns in a single operation.

- When loading Programs, Combinations, Songs, or Drum Kits, you must make sure that the Global mode memory protect setting is unchecked. For details, please see "Memory protect" on page 90.

Note: Please see page 90 for details on the media from which you can load data.

1. **Make sure that the media is ready for you to load data. For details, please see "Inserting/removing a card in the SD card slot" on page 91.**
2. **Access the Media- Load page. Press the Load tab.**
3. **Press the .PCG file containing the program and combination data you want to load, so that the file is highlighted.**
 - If there are directories, press the Open button to move to a lower level, or press the Up button to move back to the higher level.

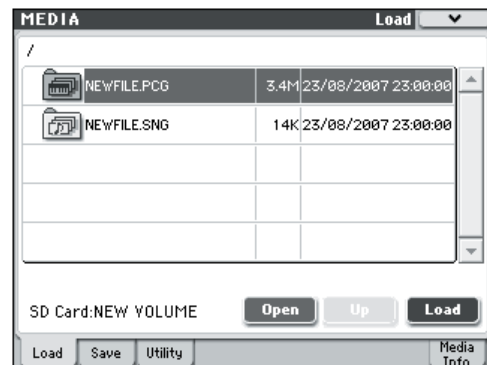

4. **Press the Load button. Alternatively, choose the menu command "Load Selected."**

A dialog box will appear.

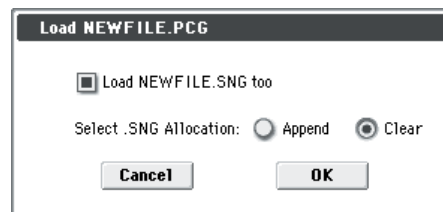

5. **If you want to load song data at the same time, select the "Load *****.SNG too" box. When you execute the load operation, the .SNG file will be loaded together with the .PCG file.**

Use "Select .SNG Allocation" to specify the destination to which the song data will be loaded.

“Append” will load the song into the song number that follows the song(s) currently existing in internal memory, without leaving a vacant number.

“Clear” will erase all songs from internal memory, and load the songs into the numbers from which they were saved.

6. Press the OK button. All data from the .PCG file will be loaded into the M50.

 Never remove the media while data is being loaded.

Note: You can load individual banks of programs or combinations. For details, please see PG page 267–.

Loading individual data from a .PCG file

The M50 lets you load Programs, Combinations, Drum kits, user Drum Kit patterns, User Arpeggio patterns individually or by individual banks. This is a convenient way to rearrange Combinations in the order in which you will use them during a live performance.

 Be aware that if you change the order of Programs, the sounds played by Combinations may also be affected.

As an example here, we will explain how a combination saved in bank A can be loaded into D000.

1. Move to the “Bank A” directory, and select the Combination that you want to load. (.PCG file/ Combinations/Bank A/)

The procedure is as follows:

- Perform steps 1–3 under “Loading all Programs, Combinations, Drum Kits and Arpeggio patterns” on page 93. Select the .PCG file containing the data you want to load (it will be highlighted), and press the Open button.
- Press “Combinations” to highlight it, and press the Open button.
- Press “Bank A” to highlight it, and press the Open button.
- Press the scroll bar to find the Combination you want to load, and highlight it.

Alternatively, you could select any file, since the desired file can be selected later from the dialog box.

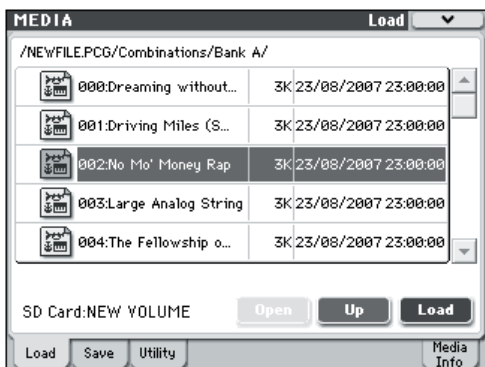

Note: When you press the keyboard of the M50, you will hear the combination you have selected. However, the internal programs will be used as the program of each timbre.

2. Press the Load button. Alternatively, choose the menu command “Load Selected.”

A dialog box will appear.

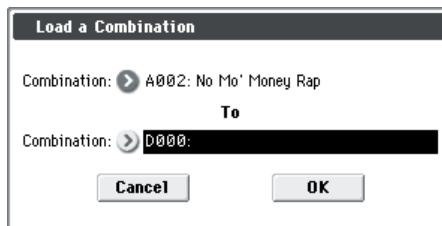

3. Use the “Combination” (upper line) to select the load-source combination, and use “(To) Combination” (lower line) to specify the destination combination. For this example, select D000.

You can press the popup button and select from a menu, or use the BANK SELECT switches and numeric keys to make a selection.

4. Press the OK button to execute loading; the loaded combination will be assigned to D000.

Loading songs for use in Sequencer mode (.SNG)

As an example here, we will explain how to load a song. We’ll assume that this song uses edited programs, multisamples you sampled and programs that use drumkit and user arpeggio patterns etc. In such cases, it is best to load “all data.”

- 1. Perform steps 1–3 under “Loading all Programs, Combinations, Drum Kits and Arpeggio patterns” on page 93. Select the .SNG file containing the data you want to load (it will be highlighted).**
- 2. Press the Load button. Alternatively, choose the menu command Load Selected.**

A dialog box will appear.

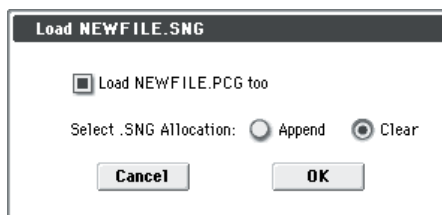

Note: The contents and settings of the dialog box will differ depending on the type of file that you are loading.

3. Check the “Load ***.PCG too” check box.**

When you execute loading, the .PCG file will be loaded along with the .SNG file.

Use “Select .SNG Allocation” to specify the destination to which the song data will be loaded.

“Append” will load the song into the song number that follows the song(s) currently existing in internal memory, without leaving a vacant number.

“Clear” will erase all songs from internal memory, and load the songs into the numbers from which they were saved.

4. Press the OK button to execute loading.

 Never remove the media while data is being loaded.

Loading M50 system update data

You can update the M50's system by downloading the most recent version of the system file from the Korg website (<http://www.korg.com>) to your computer, and loading it into the M50. For details on the procedure, refer to the Korg website and to "Update System Software" on page 252 of the Parameter Guide.

Use the Global mode menu command **Update System Software** to load the system update data.

Media utility

Formatting media

Newly purchased media or media that has been used by another device cannot be used “as is;” you must format the media before you can use it with the M50.

- ⚡ When you format media, all data that had been saved on that media will be erased. Be sure to double-check media for data before you format.
 - ⚡ After formatting, it is not possible to press the COMPARE switch to return to the previous state.
1. **Make sure that the media you want to format is inserted. For details, please see “Inserting/removing a card in the SD card slot” on page 91.**
 2. **Access the Media- Utility page. Press the Utility tab.**
 3. **Press the menu button to access the menu, and press “Format” to open the dialog box.**

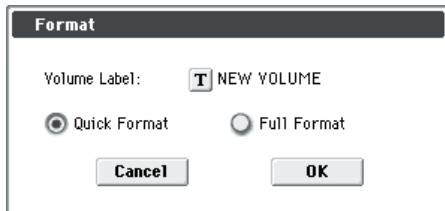

4. **In “Volume Label,” use the text edit button to access the text edit dialog box, and specify the volume label.**

The previously-specified volume label will be displayed. If no volume label had been specified for the media, or if a non-DOS media was inserted, this will indicate “NEW VOLUME.”

5. **Specify the initialization format.**

Quick Format: Normally you should use Quick Format to initialize the media.

Full Format: All blocks on the media will be erased. Normally, there is no need to apply a Full Format; you should simply execute Quick Format.

6. **Press the OK button to format, or press the Cancel button if you decide to cancel.**

When you press the OK button, a message will ask you for confirmation. Press the OK button once again to execute the Format operation.

- ⚡ You must use the M50 to format the media. The M50 will not correctly recognize media that has been formatted by another device.

Specifying the save date and time

Specify the date and time; this is used to record the correct date and time when you save data. You can set the date and time by using the Media Utility page’s **Set Date/Time** menu command.

- ⚡ The M50 does not contain an internal calendar or clock, you must use the Utility menu command **Set Date/Time** to set the date and time before saving the file.

1. **Press the MODE MEDIA switch to enter Media mode.**
2. **Access the Media- Utility page. Press the Utility tab.**
3. **Open the menu, and select the Set Date/Time command.**

The following dialog box will appear.

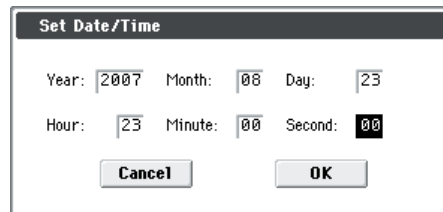

4. **Use the VALUE controllers to set the correct year, month, day, hour, minute, and second.**
5. **Press the OK button.**

Appendices

Restoring the factory settings

Loading the preloaded data

The original preload data is backed up in the M50, so you can restore any or all of the Programs, Combinations, Drum Kits, User Arpeggio Patterns, and Global settings to their original factory settings. The original demo songs can also be re-loaded at any time. For details, please see “About the data loaded by All Preload PCG.”

User banks and user patterns into which preload data has not been loaded will remain unchanged. If you want to erase user banks or user patterns, initialize the M50 and then load the preload data. For more details, please see “Initialization” on page 102.

- ⚠ Never turn off the power while the data is being loaded.
- ⚠ Before you load the preload data, go to the Global mode P0: Basic Setup– System Preference page, and uncheck the “Memory Protect” settings for the data that you want to load. If you execute this operation with these settings checked, the data will not be loaded.
- ⚠ Loading the preloaded data will overwrite the contents of the internal memory. If you want to keep the existing data that is stored in internal memory, use “Save All (PCG&SNG)” or “Save PCG” to save your data to external media before you continue.

1. Access the Global mode P0: Basic Setup– Basic page.

Press the MODE GLOBAL switch to enter Global mode.

If the Global P0: Basic Setup– Basic page is not shown, press the EXIT switch.

2. Press the menu button, and choose “Load Preload/ Demo Data.”

A dialog box will appear.

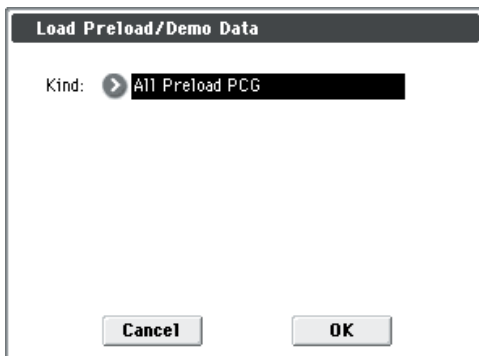

3. In the “Kind” field, select All Preload PCG.

4. Press the OK button to load the preload data. If you decide not to load the preload data, press the Cancel button.

When you press the OK button, a dialog box will ask you for confirmation. Press the OK button to execute loading.

Note: When the dialog box is displayed, the ENTER switch performs the same function as the OK button.

About the data loaded by All Preload PCG

When you execute All (Preload PCG and Demo Song), the Demo Song data will be loaded in addition to the Preload PCG data.

When you execute All Preload PCG, the following data will be loaded:

- Program: Bank A, B, C, D, E (000–095)
- Combination: Bank A, B, C
- Drum Kit: 00(INT)–47(INT)
- User Arpeggio Pattern: U0000(INT)–U1027(USER)
- Global Setting
- Demo Song: S000–S003
Only when executing All (Preload PCG and Demo Song)

Note: Demo song data will be erased when the power is turned off.

Troubleshooting

If you experience problems, please see the relevant item and take the appropriate measures.

Power supply

Power does not turn on

Is the AC adapter connected to an outlet? → p.1

Is the rear panel POWER switch turned on? → p.23

Display

The power is turned on, but nothing is shown on the display. The M50 functions normally when you play the keyboard or perform other operations.

Use the rear panel Contrast adjustment knob to adjust the contrast of the display. → p.10

The power is turned on, but the display does not work normally, or an error message is displayed. There is no sound when you play the keyboard, and the M50 does not function normally.

This type of problem may occur if a data writing operation to internal memory was not completed correctly, for example, if the power of the M50 was turned off while a program or other data was being written. If this occurs, use the following procedure to initialize the M50's internal memory.

1. **Turn off the power.**
2. **While holding down the RESET CONTROLS switch and the REALTIME CONTROL switch located beside it, turn on the power of the M50.**

The M50 will be initialized, and data will be written into internal memory. While the data is being written, the display will indicate "Now writing into internal memory."

After initialization, all user data will be empty, and you will need to re-load the preload data. Execute the Global mode menu command **Load Preload/Demo Data** to load the data. → p.97

Operations in the display don't work, the position has drifted, the response is poor

On the Global P0: Basic Setup page, use the **Touch Panel Calibration** menu command to adjust the touch panel response. → PG p.252

You can perform the calibration more accurately by using a touch pen or similar object to touch the center of the square, top/bottom/left/right, or the desired direction. Normally you should use the center of the square to perform the calibration.

Note: If you are unable to select commands from the menu, do the following:

1. **Press the GLOBAL switch.**

2. **Press the EXIT switch twice.**

3. **Hold down the ENTER switch and press 3 on the numeric keypad.**

The Touch Panel Calibration page will appear. Follow the on-screen instructions to re-calibrate the touch panel.

Can't switch modes or pages

If you're doing any of the following, you may not be able to change modes or switch to a different page:

- Recording or playing back a song or pattern

In Combination, or Sequencer modes, you can't edit the value of Timbre/Track parameters such as MIDI Channel or Status

Some parameters can't be edited while notes are playing, either locally or from MIDI. If the damper pedal is held down, or if its calibration is incorrect, notes may be sustaining even if they aren't audible.

- Are you using a damper pedal with a polarity that does not match the **Damper Polarity** setting (Global P2: Controllers- Foot Controllers)? → PG p.228
- In some cases, this problem can be solved by executing the menu command **Half Damper Calibration** (Global P0: Basic Setup). → PG p.252

No beep sounds when you touch the display

Check the **Beep Enable** check box (Global P0: Basic Setup- System Preference). → PG p.218

Audio output

No sound

Are connections made correctly to your amp, mixer, or headphones? → p.24

Is the connected amp or mixer powered-on, and is its volume raised?

Is Local Control turned on?

- In Global P1: MIDI, check the **Local Control On** check box. → PG p.220

Is the VOLUME slider raised? → p.10

Is the Master Volume assigned to **Foot Pedal Assign**, and is that pedal volume lowered? → p.84

If a specific timbre doesn't sound in Combination mode, is its Play/Mute button set to Play?

Alternatively, are all Solo button settings turned off? → PG p.82

If a specific track doesn't sound in Sequencer mode, is its Play/Rec/Mute button set to Play? Alternatively, are all Solo button settings turned off? → PG p.131

Make sure that the **Status** is INT or BTH. → p.49, p.55

Are the Key Zone and Velocity Zone set so that sound will be produced when you play? → PG p.17, p.99, p.156

Is the Oscillator, Drum Track, Timbre, or Track level lowered in the control surface mixer? → PG p.4, p.83, p.133

Could the level of the **Master Volume** following the total effect have been lowered? → PG p.71, p.118, p.180

Could the total polyphony be exceeding the maximum polyphony of 80 voices? → PG p.21, p.234

Notes do not stop

In Prog P1: Basic/Ctrl- Key Zone/Scale, select the Program Basic page, make sure that the **Hold** check box is unchecked. → PG p.17

Did you use Tone Adjust to turn **Hold** on? → PG p.9

In Global P2: Controller, make sure that **Damper Polarity** or **Foot Switch Polarity** is set correctly. → PG p.228

If the DRUM TRACK ON/OFF or ARP ON/OFF switches are turned on, try turning them off.

Notes are sounded in duplicate

Is Local Control turned Off?

- Clear the **Local Control On** checkbox (Global P1: MIDI). → PG p.220

Noise or oscillation is heard

When using the MIDI/Tempo Sync function to control the delay time of an effect, noise may occur in the delay sound. This noise is due to discontinuities in the delay sound, and is not a malfunction.

Some effects, such as 017: Stereo Analog Record, generate noise intentionally. It is also possible to create oscillation using a filter with resonance. These are not malfunctions.

Note that if you use the following effects with the routing described below, a feedback loop will be created, possibly producing a loud noise. Please use caution.

If the signal from an oscillator or timbre/track output, or the signal after an insert effect, is sent to the FX Control bus and that signal is output directly, with this output sent to the FX Control bus, a loud noise may be output. (It is also possible that a DC component will be output at the maximum level, producing silence.)

- When using the 002: Stereo Limiter or 005: Stereo Gate, and the **Envelope Source** of these effects is set as either FX Control 1 or FX Control 2, and **Trigger Monitor** is On.
- When using 156: Vocoder, with the **Modulator Source** set to FX Control 1 or FX Control 2, and the **Modulator High Mix** set to other than 0.

Can't play chords

Could the program's **Voice Assign Mode** be set to Mono? → PG p.15

Pitch is incorrect

- In the Global P0: Basic Setup page, are the **Master Tune** and **Transpose** settings correct? → PG p.216
- In the Prog P2: OSC/Pitch page, is the **Pitch Slope** set to +1.0? → PG p.23
- In the combination or song, are the **Transpose** and **Detune** settings of each timbre/track set appropriately? → PG p.97, p.153
- In the timbre/track settings of each program, combination, or song, could you have selected a

non-standard scale type other than Equal Temperament? → PG p.17, p.98, p.154

Programs and Combinations

Settings for oscillator 2 are not displayed

Make sure that the **Oscillator Mode** (Prog P1: Basic/Ctrl) parameter is set to Double. → p.34

Program does not sound

Could the oscillator or amp level be lowered? → PG p.4, p.5, p.41

A combination does not play correctly after you load data

In the dialog box when you saved the data, did you check the items that you wanted to save? → PG p.267

Are the bank/numbers of the programs used by the combination the same as when the combination was created?

- If you have switched program banks, you can use the **Change all bank references** menu command to change the program bank for each timbre of a combination. → PG p.251

Can't write a Program

Is the Memory Protect **Program** or **Combination** checkbox (Global P0) cleared? → p.84, PG p.219

Songs

Song does not play correctly after being loaded

In the dialog box when you saved the data, did you check all of the items that you wanted to save? → PG p.267

Are the programs used by the song the same as when the song was created?

- If you have switched program banks, you can use the menu command **Change all bank references** to change the program bank for each track of a song. → PG p.251
- When saving the song, it is best to use **Save All (PCG&SNG)** so that the programs are saved together with the song. Then when loading, load both the .PCG and the .SEQ data. → PG p.267

Playback does not start when you press the SEQUENCER START/STOP switch in Sequencer mode

Is the **MIDI Clock** (Global P1: MIDI) set to Internal or Auto? → PG p.221

Can't record in Sequencer mode

Did you use **Track Select** to select the MIDI track that you want to record? → p.57

Is the Memory Protect **Song** check box (Global P0) unchecked? → p.84, PG p.219

Is the **MIDI Clock** (Global P1: MIDI) set to Internal or Auto? → PG p.221

A combination copied using “Copy From Combi” doesn’t record via arpeggiator as it did when you were playing it in Combination mode

Is **Multi REC** (Seq P0: Play/REC) checked? → p.58, PG p.139

Are the settings in the Copy from Combination dialog box correct? → p.60

- In the Copy from Combination dialog box, check the **Auto adjust Arp setting for Multi REC** option before you execute the copy. This will cause the settings to be adjusted automatically.

Can’t record Tone Adjust data

Changes you make using Tone Adjust are recorded as system exclusive data. Did you check the Global mode MIDI Filter **Enable Exclusive** check box? → PG p.224

RPPR does not start

Is the Seq P0: Play/REC **RPPR** setting checked? → p.64

Are **Assign**, **Pattern Select**, and **Track** set correctly? → p.63

Is the **MIDI Clock** (Global P1: MIDI) parameter set to Internal or Auto? → PG p.221

SMF you loaded in Media mode won’t play correctly

Execute the menu command **GM Initialize** to restore the settings. → PG p.193

Set **Bank Map** to GM(2). → PG p.218

Arpeggiator

The Arpeggiator does not start

Is the ARP ON/OFF switch turned on (lit)? → p.73

If the arpeggiator does not start for a combination or song, make sure that **Arpeggiator Run** is checked, and that an arpeggiator is selected for **Assign**. → p.76, PG p.84, p.108, p.142

If the arpeggiator does not run in the Global P6: Arpeggio Pattern page, could you have navigated there from Combination or Sequencer mode with settings that do not start the arpeggiator?

Is the **MIDI Clock** (Global P1: MIDI) parameter set to Internal? → PG p.221

In the Global P0: Basic Setup page, is **All ARP/DT Off** checked? → PG p.217

Drum Track function

The Drum Track does not start

Is the DRUM TRACK ON/OFF switch turned on (lit)? → p.79

You pressed the DRUM TRACK ON/OFF switch but the drum track pattern did not start.

- Is the DRUM TRACK ON/OFF switch blinking? **Trigger Mode** is set to Wait KBD Trig. The drum track pattern will start when you play the keyboard or receive a note-on. → PG p.62
- Did you select a pattern that does not contain data?
- Could P000: Off be selected as the pattern? → PG p.62

If the drum track pattern fails to start in Combination mode, is the **Output Channel** setting appropriate?

If the drum track pattern fails to start in Sequencer mode, are the **Input Channel** and **Output Channel** settings appropriate? → p.79, PG p.172

Is **MIDI Clock** (Global P1: MIDI) set to Internal or Auto? → PG p.221

In the Global P0: Basic Setup page, is **All ARP/DT Off** checked? → PG p.217

Drum Kits

The drumsample’s pitch does not change

You have left the **Assign** check box unchecked, and want to play the drumsample at the adjacent right a semitone lower, but the pitch does not change.

- If you have selected a drum program in Program mode, and then want to edit the drum kit in Global mode, go to the Prog P2: OSC/Pitch– OSC1 Pitch page and set **Pitch Slope** to +1.0 before you enter Global mode. → PG p.23

Effects

Effects are not audible

Have you selected effect program 000?

- Select an effect other than 000: No Effect for “IFX1–5,” “MFX 1, 2” or “TFX.”

Are the Effect Global SW **IFX 1–5 Off**, **MFX1&2 Off**, or **TFX Off** (Global P0: Basic Setup page) settings checked? → PG p.217

If you are in Combination and Sequencer mode, and master effects are not audible when you raise the **Send1** or **Send2** of the timbre/track, does **Return 1** or **Return 2** from the master effect need to be raised? → PG p.70, p.118, p.180

Alternatively, has **Send 1** or **Send 2** for each oscillator of the program used by the timbre/track been lowered? → PG p.114, p.175

Note: The actual send level is determined by multiplying the send setting of each oscillator in the program with the send setting of the timbre/track.

Have you routed the output to an insert effect?
→ PG p.65, p.115, p.117, p.175, p.176

MIDI

The M50 does not respond to incoming MIDI data

Are all MIDI cables or USB cables connected correctly?
→ p.26

Is the MIDI data being received on the channel on which it is being transmitted? → PG p.392

The M50 does not respond correctly to incoming MIDI data

Are the Global P1: MIDI settings **MIDI Filter Enable**, **Program Change**, **Enable Bank Change**, **Enable Control Change**, **Enable AfterTouch**, and **Enable Exclusive** each checked? → PG p.223

Does the M50 support the types of messages that are being sent to it? → PG p.392

Incorrect response to program change messages

Is the **Bank Map** setting correct? → PG p.218

Damper pedal does not respond correctly

Damper response is wrong

Execute the menu command **Half Damper Calibration** (Global P0: Basic Setup) to correctly calibrate the half-damper pedal sensitivity. → PG p.252

Media

Can't format the SD card

Does the media meet the requirements for use on the M50? → p.91

Is the media inserted correctly? → p.91

Could the media's write protect setting be turned on?

Can't save/load data on the SD card

Is the media inserted correctly? → p.91

Has the media been formatted? → p.96

Could the media's write protect setting be turned on?

The date of the data is wrong

The files you saved have the incorrect date.

- The M50 does not contain an internal calendar. Use the menu command **Set Date/Time** (Media- Utility page) to specify the current time and date before you save the data. → p.96

Connections with a computer

The M50 does not respond to MIDI data sent from outside

Is the USB cable connected correctly? → p.26

The computer does not detect the M50

Are the USB cables connected correctly?

An error occurs when you disconnect from the computer

Never disconnect the M50 from the computer while your host application is in use.

While connected, you are asked to install software or a device driver

Does the operating system version of your computer support the M50? → p.109

When using USB, sound processing is slow, or the tempo is unstable

Is the MIDI driver installed for the USB port you've connected?

- The driver must be installed for each USB port you use. If you connect the M50 to a USB port other than the port you used when installing the KORG USB-MIDI Driver for Windows, you'll need to reinstall the KORG USB-MIDI Driver.

Included CD-ROM

Can't install the driver

Is the USB cable connected correctly?

Is the CD-ROM inserted in your CD drive?

- Make sure that the CD-ROM is inserted correctly.

Is the lens of your CD drive dirty?

- Use a commercially-available lens cleaner to clean the lens.

Are you able to use USB?

- If you are using Windows XP, go to [Control Panel] → [System], and select the [Hardware] tab. In [Device Manager], check the settings for Universal Serial Bus Controller and USB Root Hub.

Has the M50 been detected as an unknown device?

- If you are using Windows XP, go to [Control Panel] → [System], select the [Hardware] tab, and check [Device Manager]. If the M50 has not been detected correctly, it will be displayed in "Other devices" or "Unknown devices." Reconnect the USB cable; if the M50 is again displayed as an "Unknown device," the computer has failed to detect it correctly. Delete the "Unknown device" entry, and reinstall the driver.

Your software does not respond to the M50

Is the USB cable connected correctly?

Did you install the driver?

Has your computer detected the connected M50?

- If you are using Windows XP, go to Control Panel → "Sounds and Audio Devices Properties" and click the Hardware tab.

If you are using Mac OS X, go to Macintosh HD → Application folder → Utility folder → "Audio MIDI Settings," select the "MIDI Devices" tab, and check that the M50 has been detected.

 Some computer hardware configurations may not recognize the M50.

Check the M50's assignments and USB-MIDI port settings.

The connected device or software may not support the messages you are transmitting. Refer to the manual of the connected device or software to verify that it responds to the messages you are transmitting.

If you want to transmit and receive system exclusive data, the MIDI Filter **Enable Exclusive** dialog box must be selected (Global P1: MIDI- MIDI Routing page).

This setting must be selected if you've connected the M50 to your computer and want to edit the M50 from your computer (or to edit bi-directionally). Select this if you're using the M50 Editor/Plug-In Editor. The MIDI Filter **Exclusive** setting is selected by default.

Note: The multisample and preset pattern list have been updated in version 1.0.1 of M50 Editor/Plug-In Editor. In order to maintain compatibility of the display in the edit window, please download and use the most recent version of the editor.

You can download the most recent versions of the editor, plug-in editor, and Korg USB-MIDI driver from the following website.

Korg website: "http://www.korg.com/"

Initialization

If operation of the M50 should become unstable, you can initialize it.

Turn off the power, and then, while holding down the RESET CONTROLS switch and REALTIME CONTROL switch, turn the power on.

The M50 will be initialized. While the data is being loaded, the display will indicate "Now writing into internal memory."

When initialization is completed, you'll need to load the preload data. Go to Global mode, and execute the menu command **Load Preload/Demo Data** to load the data. (See PG p.251)

Error messages

Error and confirmation messages

A

Are you sure ?

Meaning: This message asks you to confirm execution. To execute press the OK button. To cancel, press the Cancel button.

C

Can't calibrate

Meaning: Calibration could not be performed correctly.

- Try again.

Can't copy/swap double size effect

Meaning: When copying or swapping an insertion effect or master effect, you attempted to place a double-size effect in IFX5 and MFX2.

- Modify your settings so that a double-size effect is not moved to IFX5 or MFX2, and execute again.

Can't open pattern

Continue?

Meaning: When you finished recording, there was not enough memory to open the pattern that was put into the track (When it must be opened automatically). If you press the OK button, the pattern data will be deleted, and the recorded or edited content will be saved. If you press the Cancel button, the recorded content will be discarded.

Completed

Meaning: Execution of the command ended normally.

Completed. Please turn the power off, and then on again

Meaning: Execution of Update System Software has been completed successfully. Turn the power switch off, and then on again to complete the update.

D

Destination and source are identical

Meaning: When copying or bouncing, the same song, track or pattern was selected for both the source and destination. To solve this problem:

- Select a different song, track, or pattern for the source and destination.

Destination from-measure within the limits of source

Meaning: When executing the Move Measure command for all tracks or within the same track, the specified destination measure is within the source range. To solve this problem:

- Set a destination measure that is outside of the source range.

Destination is empty

Meaning: When editing, the track or pattern that was specified as the destination contains no musical data. To solve this problem:

- Select a track or pattern that contains musical data.

Destination measure is empty

Meaning: The measure that was specified as the destination contains no data.

- Specify a destination measure that contains data.

Destination song is empty

Meaning: The song that was specified as the copy destination or bounce destination does not exist.

- Execute the Create New Song command in the dialog box that appears when a new song is selected before copying or bouncing.

Directory is not empty

Cleanup directory

Are you sure?

Meaning: When deleting a directory, files or directories exist within that directory.

- Press the OK button to delete all files and/or directories within that directory.

Disk not formatted

Meaning: When you attempted to perform a high-level format (quick format) of media, the media had not been physically formatted yet. To solve this problem:

- Execute the Media mode Utility menu command **Format** to physically format the media (full format).

E

Error in formatting medium

Meaning: An error occurred while performing a physical format (full format) or high-level format (quick format) of the media. To solve this problem:

- Use other media.

Error in reading from medium

Meaning: An error occurred while reading data from media. This error may also appear when data is being written to media by a Save or Copy operation. To solve this problem:

- Execute the reading operation once again. If the same error occurs, it is possible that the data on the media has been damaged.

Error in writing to medium

Meaning: A verification error occurred while writing data to a medium. To solve this problem:

- It is possible that the media has been physically damaged. Try another media. Avoid using the media that produced the error.

F

File already exists

Meaning: When executing a **Create Directory** or **File Rename** operation, a directory or file of the same name already exists on the media.

Meaning: When executing the Media mode Utility **Copy** command without using wild cards, the copy destination contained a file of the same name as the copy source.

- Either delete the existing directory or file, or specify a different name.

File unavailable

Meaning: You attempted to load or open a file whose format was incorrect.

File/path not found

Meaning: When executing the **Delete** command in the Media mode Utility page, the specified file did not exist.

Meaning: When executing the **Copy** command in the Media mode Utility page, and you used a wild card to specify the copy file name, the specified file was not found. Alternatively, the length of the copy source path name exceeded 76 characters.

Meaning: In Media mode when you used the Open button to open a directory, the path length including the selected directory name exceeded 76 characters.

- Check the file or directory.

I

Illegal file description

Meaning: The filename that you specified when saving a file or creating a directory contained invalid characters. To solve this problem:

- Change the filename you are specifying. Filenames not permitted by MS-DOS cannot be used as a filename.

Illegal SMF data

Meaning: You attempted to load a file that was not a Standard MIDI File.

Illegal SMF division

Meaning: You attempted to load a Standard MIDI File that was timecode-based.

Illegal SMF format

Meaning: You attempted to load a Standard MIDI File of a format other than 0 or 1.

M

Master Track can't be recorded alone

Meaning: When realtime-recording a single track, you attempted to begin recording with the master track as the current track.

- Select a MIDI track for recording, instead of the Master Track.

Measure number over limit

Meaning: The attempted edit operation would cause the track length to exceed 999 measures.

- Delete unnecessary measures.

Measure size over limit

Meaning: When loading a Standard MIDI File, the number of events in a measure exceeded the maximum (approximately 65,535 events).

Meaning: The attempted edit operation would cause the maximum number of events in a measure (approximately 65,535) to be exceeded.

To solve either of these problems:

- Use event editing etc. to delete unwanted data.

Medium changed

Meaning: When executing the **Copy** command in the Media mode Utility page, the media was exchanged or ejected, and it was not possible to copy between separate media on the same drive.

Medium unavailable

Meaning: You selected a medium that does not allow writing.

Medium write protected

Meaning: The other writing-destination media is write-protected.

- Turn off write protect on the other media, and execute the command once again.

Memory full

Meaning: When editing a song, track or pattern in Sequencer mode, the total data of all songs has used up all of the sequence data memory, and further editing is not possible. To solve this problem:

- Delete other song data etc. to regain free memory.

Meaning: While realtime recording in Sequencer mode, there is no more free memory to accommodate the recorded data, so recording has been forcibly halted. To solve this problem:

- Delete other song data etc. to regain the amount of free memory.

Memory overflow

Meaning: While receiving exclusive data in Media mode **Save Exclusive**, all remaining internal memory was used up. To solve this problem:

- If you are receiving two or more sets of exclusive data, transmit them separately to the M50.

Memory Protected

Meaning: The internal program, combination, song, drum kit, user arpeggio pattern is protected.

Meaning: The song was protected when you executed Auto Song Setup.

- In Global mode, turn off write-protect, and execute the write or load operation once again.

MIDI data receiving error

Meaning: While receiving MIDI System Exclusive data, the format of the received data was invalid, for example, because the size of the data was incorrect.

N**No data**

Meaning: When loading a Standard MIDI File, the file contained no events.

No medium

Meaning: When executing a command in Media mode, no media was inserted in the drive. To solve this problem:

- Insert media.

No recording track specified

Meaning: When performing realtime multi-track recording, you attempted to begin recording with no tracks set to REC. To solve this problem:

- Set the desired tracks for recording to REC.

No space available on medium

Meaning: When you attempted to save or copy a file, or to create a directory, there was not enough free space on the other medium. To solve this problem:

- Either delete an existing file, or replace the medium with another that contains sufficient free space.

Not enough Drum Track pattern locations available

Meaning: When converting a song's user pattern to a user drum track pattern, you have exceeded the number of user drum track patterns available for use.

- As necessary, execute the Media mode **Save PCG** command to save your user drum track patterns. In Sequencer mode, execute the menu command **Erase Drum Track Pattern** to increase the number of available drum track user patterns. Then try the conversion operation again.

Not enough Drum Track pattern memory

Meaning: When converting a song's user pattern to a user drum track pattern, there was not enough free memory.

- As necessary, execute the Media mode **Save PCG** command to save your user drum track patterns. In Sequencer mode, execute the menu command **Erase Drum Track Pattern** to erase other user drum track patterns and increase the amount of free memory. Then try the conversion operation again.

Not enough memory

Meaning: When starting realtime recording in Sequencer mode, the minimum amount of free memory (such as memory for the BAR events up to the recording start location) could not be allocated. To solve this problem:

- Delete other song data etc. to regain free memory.

Not enough memory to load

Meaning: When you attempted to load a .SNG file or a standard MIDI file in Media mode, there was insufficient free memory in the sequence memory. To solve this problem:

- Delete other song data etc. to regain free memory.

Not enough memory to open pattern

Meaning: There was insufficient sequencer memory to open the pattern, so editing is not possible.

- Either delete unwanted data such as a song, track, or pattern, or do not open the pattern.

Not enough pattern locations available

Meaning: When executing **Load Drum Track Pattern**, the attempted load operation would exceed the remaining number of user patterns in the selected song.

- Create a new song, and reload the data into the user patterns of that song. You can load up to 100 user patterns into each song. If you have more drum track patterns than this to load, you can divide them between two or more songs.

Not enough song locations available

Meaning: When loading a .SNG file with **Append** specified, you attempted to load more songs than can be loaded.

- In Sequencer mode, execute **Delete Song** to increase the number of songs that can be used, and then load the song again.

P**Pattern conflicts with events**

Meaning: It was not possible to execute the Bounce operation because one of the tracks contained a pattern, and the same measure of the other track contained events or a pattern.

- Open the pattern.

Pattern exists across destination to-end-of-measure or source from-measure

Meaning: When moving a measure, the edit operation could not be executed because a pattern had been put in the destination-end measure, or the source-start measure, and had not been opened.

- Open the pattern.

Pattern exists in destination or source track**Open pattern?**

Meaning: A pattern has been placed in the track that you specified as a destination or source for editing. If you wish to open the pattern and execute (the events of the pattern will be copied), press the OK button. If you wish to execute without opening the pattern, press the Cancel button.

Pattern used in song**Continue ?**

Meaning: When editing, the specified pattern has been placed in a track. If you wish to execute, press the OK button. If you decide not to execute, press the Cancel button.

R**Root directory is full**

Meaning: Your attempt to create a file or directory in the root directory of the media would exceed the maximum number of root directory entries.

- Either delete an existing file or directory, or Open a directory to move down one level before creating a file or directory.

S**Selected file/path is not correct**

Meaning: When loading a divided .PCG file, you attempted to load a .PCG file of the same name that was not divided or had differing contents.

- Load the correct .PCG file.

Source is empty

Meaning: No data exists in the track or pattern that you specified as the source.

- Specify a track or pattern that contains musical data.

Meaning: This message will appear when you execute Swap Insert Effect if one of the effects to be swapped (“Source1” or “Source2”) is a double-size effect, and is therefore an unusable IFX number.

- If you want to execute the Swap operation on a double-size effect, specify an IFX number to which a double-size effect is assigned.

T**The internal memory has been corrupted, likely due to an interruption of power while the system was writing/saving data. This has been repaired and the affected Bank has been initialized. [OK]**

Meaning: A memory-write operation failed because the power was turned off while writing data to internal memory (e.g., while writing a program).

- Turn the power off, and then on again. The M50 will automatically initialize its internal memory. This message will be displayed during this time. Press OK to close the dialog box. As necessary, for example if the preloaded bank was initialized, use the Global mode Load Preload/Demo Data command to load the preload data into internal memory.

There is not readable data

Meaning: Either the file size is 0 or the file does not contain data that can be accessed by the load or open operation. Alternatively, the data is damaged etc., and cannot be loaded or accessed.

This file is already loaded

Meaning: When loading a divided .PCG file, you attempted to load a file that had already been loaded.

- Load the .PCG files that have not yet been loaded.

U**Unable to create directory**

Meaning: You attempted to create a directory that would exceed the maximum path name length (76 characters for the full path name).

Unable to save file

Meaning: When executing the Media mode Utility menu command **Copy**, the copy destination path length exceeded 76 characters.

Meaning: When saving a file in Media mode, the save destination path exceeded 76 characters.

Meaning: When you executed the Media mode Utility menu command **Copy**, the file management data exceeded the size of the management area.

Y**You can't undo this operation Are you sure?**

Meaning: Once you enter event editing (even if you leave event editing without actually editing an event), it will no longer be possible to execute Compare to listen to the previous edit. If you wish to enter event editing, press the OK button. To cancel, press the Cancel button.

You can't undo last operation Are you sure?

Meaning: When you exit recording or event editing in Sequencer mode, the memory area for Undo (Compare function) is not allocated. If you wish to keep the data that was just recorded or edited, press the OK button. If you wish to return to the previous data (i.e., to delete the data that was just recorded or edited), press the Cancel button.

Meaning: When editing in Sequencer mode, memory area for Undo (Compare function) cannot be allocated. If you wish to execute the edit, press the OK button (It will not be possible to undo your edit). If you decide not to execute the edit, press the Cancel button.

- In order to allocate memory area for Undo (Compare function), delete unneeded data such as songs, tracks, or patterns. We recommend that you data to media before you execute the edit operation.

Specifications and options

Specifications

Operating temperature	±0 – +40 °C		
Keyboard	88	88 key Real Weighted Hammer Action (RH3) (no aftertouch) * The key weight of the RH3 keyboard differs in four stages across the pitch range (with low notes being heavier, and high notes being lighter), delivering a playing feel similar to that of a grand piano.	
	61	Natural Touch Keyboard (no aftertouch)	
System	EDS (Enhanced Definition Synthesis)		
Sound Engine	Maximum Polyphony	80 voices max, single mode 40 voices max, double mode * The actual maximum polyphony will vary depending on oscillator settings such as stereo multisamples and velocity crossfading.	
		Preset PCM	256 Mbytes (when calculated as 16-bit linear data) 1,077 multisamples (including seven stereo), 1,609 drum samples (including 116 stereo)
	Programs	Oscillator	OSC1 (Single), OSC1+2 (Double): Stereo multisamples are supported 4 velocity zones per oscillator, with switching, crossfades and layers.
		Filters	Four types of filter routing (single, serial, parallel, 24 dB) Two multi-mode filters per voice (low pass, high pass, band pass, band reject)
		Driver	Per-voice nonlinear driver and low boost.
		EQ	Three bands, with sweepable mid.
	Combinations	Modulation	For each voice, two envelope generators (Filter & Amp), two LFOs, two key tracking generators (Filter & Amp), and two AMS mixers In addition, pitch EG, common LFO, and two common key tracking generators
		16 Timbres	Up to sixteen timbres, keyboard and velocity split/layer/crossfade, and modifications to the program setting via the Tone Adjust function
	Drum Kits	Master Keyboard functionality	These allow you to control external MIDI devices
		Drum Kits	Stereo and mono drumsamples. 4-way velocity switches with crossfades and adjustable crossfade shapes (Linear, Power, Layer).
	The number of ... -Combinations -Programs -Drum Kits	User Combinations	512 Combinations/384 Preload
		User Programs	640 Programs/608 Preload
		User Drum Kits	48 Drum Kits/32 Preload
Preset Programs		256 GM2 Programs + 9 GM2 Drum Programs	
Effects	5 Insert Effects	In-line processing; stereo in - stereo out.	
	2 Master Effects	Two effects sends; stereo in - stereo out.	
	1 Total Effect	For overall processing on the main outputs, such as compression, limiting, and EQ; stereo in - stereo out.	
	3-band Track EQ	High, low, and sweepable mid band. Per Program in Program Mode, per Timbre in Combination mode (16 total), and per Track in Sequencer mode (16 total).	
	Effects types	170 types (Usable for insert, master, or total effects. However, double-size effects cannot be used as the total effect.)	
	Modulation	Dynamic Modulation, two common LFOs	
	Effects Control Bus	Stereo side-chaining for limiter, gates, vocoders, etc.	
	Effects Presets	Up to 32 per Effect	
Dual polyphonic arpeggiators	Program mode: one arpeggiator available. Combination and Sequencer modes: two arpeggiators available.		
	5 preset arpeggio patterns		
	1028 user arpeggio patterns (900 preload)		
Drum Track	Preset patterns	671 patterns (Held in common with sequencer preset patterns.)	
	User patterns	1,000 patterns. Patterns created in Sequencer mode can be converted to drum track user patterns.	
	Trigger Mode / Sync / Zone settings can be specified		
Sequencer	16MIDI Tracks & 1 Master Track		
	128 Songs		
	Resolution: 480 ppq (parts per quarter-note)		
	Tempo: 40.00–300.00 bpm (1/100 bpm resolution)		
	Up to 210,000 MIDI events		
	16 preset/16 user template songs		
	Cue List function	20 cue lists. Songs can be arranged consecutively or repeatedly in up to 99 steps. A cue list can be converted back into a song.	
Patterns/RPPR	671 Presets /100 User Patterns (per Song) RPPR (Realtime Pattern Play/Recording): 1 set per Song.		
Format	Korg (M50) format, SMF (formats 0 and 1) supported		

Media		Load, Save, Utility		
		Data Filer functionality (Save and Load MIDI System Exclusive Data)		
Controllers		Joystick, SW1, 2		
		Chord trigger switches	Chord trigger switches 1–4 (not velocity sensitive)	
			CHORD ASSIGN switch	
		Control Surface	CONTROL ASSIGN Switches	REALTIME CONTROL, EXTERNAL, ARP
			RESET CONTROLS Switch	
			4 knobs	REALTIME CONTROL: Realtime modulation
				EXTERNAL: External mode. External MIDI control.
		Arpeggio control		
		* In External mode, the four knobs, four chord trigger switches can be used as MIDI controllers. 128 setups can be stored. (102 are preloaded. These allow you to control software synthesizers or DAW software.)		
Drum Track		Switches = ON/OFF		
Arpeggiator		Switches = ON/OFF		
User Interface		Display		
		TouchView grey-scale graphical user interface Color 320 x 240 pixel display		
		MODE		
		Switches = COMBI, PROG SEQ, GLOBAL, MEDIA		
		Value Controllers		
		Switches = Δ / ∇ , 10-key numeric keypad, -, (,), ENTER, COMPARE, VALUE Slider, VALUE Dial		
		BANK		
Switches = A...GM (used for Combination A, B, C, D)				
SEQUENCER		Switches = PAUSE, REW, FF, LOCATE, REC/WRITE, START/STOP		
TEMPO		Switches = TAP TEMPO, TEMPO Knob		
Other		Switches = PAGE SELECT, EXIT, VOLUME Slider, display contrast		
Audio Outputs	Analog	AUDIO OUTPUT L/MONO, R	1/4" TS (Mono), unbalanced, Volume slider controls only L/Mono and R	
			Output Impedance	1.1k Ω stereo; 550 Ω mono (L/Mono only)
			Maximum Level	+16.0 dBu
			Load Impedance	10 k Ω or greater
		Headphone output	1/4" TRS (Stereo), Volume slider	
			Output Impedance	33 Ω
		Maximum Level		
		32+ 32 mW @33 Ω		
Control Inputs		DAMPER (Supports piano-style half-damper pedals as well as standard foot switches)		
		ASSIGNABLE SWITCH, ASSIGNABLE PEDAL		
MIDI		IN, OUT		
USB		1 USB (TYPE B), MIDI interface		
SD-Card slot		Capacity recognized: FAT32: 2 Gigabytes (GB). SDHC memory cards are not supported.		
Power		AC adapter power supply connector (DC 12V 3500mA  , POWER On/Off switch		
Dimensions (W x D x H)		M50-61	1,027 x 297 x 104 (mm)/40.43" x 11.69" x 4.09"	
		M50-88	1,409 x 328 x 151 (mm)/55.47" x 12.91" x 5.94"	
Weight		M50-61	6.8 kg/14.99 lbs.	
		M50-88	20.8 kg /45.86 lbs.	
Power Consumption		M50-61	35W	
		M50-88		
Accessories		AC adapter, Owner's Manuals CD-ROM (M50 Parameter Guide (PDF), Installation Guide (PDF), External Setups PDF, KORG USB-MIDI driver, M50 Editor/Plug-In Editor etc.)		

Options

XVP-10	Expression/Volume Pedal
EXP-2	Foot Controller
DS-1H	Damper Pedal
PS-1	Pedal Switch

Operating requirements

KORG USB-MIDI driver

Windows

Computer: USB port required (a USB host controller made by Intel is recommended)

Operating system: Microsoft Windows XP Home Edition/Professional/x64 Edition Service Pack 2 or later (the MIDI driver for the x64 Edition is a Beta version)

All editions of Microsoft Windows Vista Service Pack 1 or later (the MIDI driver for the 64-bit Edition is a Beta version)

Macintosh

Computer: USB port required

Operating system: Mac OS X 10.3.9 or later

M50 Editor and M50 Plug-In Editor

Windows:

- Computer

CPU: Intel Pentium III / 1 GHz or better, Pentium D or Core Duo or better is recommended

Memory: 512 MB or more (1 GB or more is recommended)

Monitor: 1,024 x 768 pixels, 16-bit color or better

A computer that satisfies the operating requirements of Windows XP or Windows Vista, and has a USB port

- Operating system

Microsoft Windows XP Home Edition/Professional Edition Service Pack 2, Windows Vista Service Pack 1 and all later editions (64-bit versions excepted)

Macintosh:

- Computer

CPU: Apple G4 800 MHz or better (Intel Mac is supported), G5 or Core Duo or better is recommended

Memory: 512 MB or more (1 GB or more is recommended)

Monitor: 1,024 x 768 pixels, 32,000 colors or better

An Apple Macintosh computer that satisfies the operating requirements of Mac OS X and has a USB port

- Operating system

Mac OS X version 10.4.11 or later

* **Formats supported by M50 Plug-In Editor:**

Windows: VST, RTAS

Macintosh: VST, Audio Unit, RTAS

* M50 Plug-In Editor must also satisfy the operating requirements of the host application.

 You cannot run multiple instances of the M50 Editor and M50 Plug-In Editor on the operating system. This means that you can't use this editor to edit two or more M50 units simultaneously.

* Appearance and specifications of this product are subject to change without notice. (Jun/'08)

Index

A

AC adapter **1, 11, 23**
 Aftertouch
 Curve **83**
 Wah **39**
 Alternate Modulation **37**
 Amp **40**
 EG **41**
 Modulation **41**
 AMS (Alternate Modulation Source) **37**
 AMS Mixer **37**
 Arpeggiator **4, 7, 10, 73, 83, 87, 100, 107**
 Performance **4**
 ASSIGNABLE PEDAL jack **11, 22, 26**
 ASSIGNABLE SWITCH jack **11, 22, 25**
 Audio equipment
 Connection **25**
 AUDIO OUTPUT **25**
 Auto punch-in **58**
 Auto Song Setup **42, 50, 60**

B

Band Pass filter **38**
 Band Reject filter **38**
 Bank
 Combination **44**
 Program **28**
 Bank select **49**
 Bank/Combination Select **44**
 Bank/Program Select **28**
 Beep **84**
 Boost **41**

C

Category **29, 44**
 Category Name **84**
 Category/Combination Select **44**
 Category/Program Select **29**
 Chord trigger switch
 Assignment **21**
 Combination **43**
 Edit **45, 47**
 Effect **71**
 Select **43**
 Common FX LFO **72**

Common LFO **36**
 COMPARE **17, 32, 47**
 Connection
 Audio equipment **25**
 Computer **26**
 MIDI device **26**
 Control Surface **3, 9, 20, 30, 74, 85**
 Controller setting **29**
 Convert
 Cue List **66**
 Drum Track pattern **52, 61**
 Copy **60**
 Auto Song Setup **60**
 Chord trigger switch **21**
 Combination **60**
 Effect **69**
 Pattern **57**
 Program **60**
 Step **65**
 Cue List **6, 7, 52, 65**
 Convert to Song **66**
 Cutoff Frequency **39**

D

Damper pedal **22, 25**
 Data filer **92**
 Demo song **5**
 Detune **50**
 Display **8, 12**
 Dmod **72**
 Double Program **34**
 Double-size effects **70**
 Drive **41**
 Drum Kit **35, 85**
 Edit **85**
 Select **35**
 Drum Program **34**
 Drum Track
 On/Off **79, 80**
 Performance **4**
 Drum Track pattern
 Select **80**
 Drum Track program
 Select **80**
 Dual Arpeggiator **73**
 Dynamic modulation **72**

E

Edit
 Combination **45, 47**
 Drum Kit **85**
 Program **30, 34**
 Song **62**
 Edit buffer **89**
 Edit cell **12**
 Effect **67**
 Bypass **83**
 In/Out **67**
 On/Off **69, 70, 71**
 Routing **69, 71**
 Select **69, 70, 71**
 EG
 Amp **41**
 Filter **39**
 Pitch **38**
 EG (Envelope Generator) **36**
 EQ **30**
 Error message **103**
 Exclusive event
 Recording **61**
 Exclusive Solo **30, 54**
 EXL **87**
 External control **85**

F

File
 EXL **87**
 MID **87**
 PCG **87**
 SNG **87**
 Filter **38**
 EG **39**
 Routing **38**
 Type **38**
 Foot pedal **26**
 Foot switch **25**
 Format **96**
 Front panel **9**

G

Gch **48**
 Global **83**
 Global MIDI channel **84**

H

High Pass filter **38**

I

- Insert effect **67, 69, 71**
- Intensity **37**
- Internal memory **87**

J

- Joystick **19**
 - Lock **20**
 - Vibrato **38**
 - Wah **39**

K

- Keyboard **20**
- Keyboard Track **40, 41**

L

- Layer **35, 48**
- LFO **36**
 - Modulation **39**
 - Speed **36, 72**
- LFO1, LFO2 **36**
- Load **93**
 - Individual data **94**
 - Preload data **97**
 - Song (.SNG) **94**
 - System update data **95**
- Local control **84**
- LOCATE **54**
- Location **54**
- Loop **54**
- Loop All Tracks **58**
- Low Pass filter **38**

M

- Manual punch-in **57**
- Master effect **67, 70**
- Media **87, 101**
 - Load **93**
 - Setup **91**
 - Types of media **91**
- Memory protect **90**
- Menu command **12, 18**
- MIDI **87**
- MIDI Channel **49**
- MIDI data dump **87**
- MIDI device
 - Connection **26**
- MIDI filter **49**
- MIDI program change **45**
- MIDI/Tempo Sync **67, 99**

Mode 14

- Effect **68**
- Select **16**
- Monophony **34**
- Multi (multitrack recording) **58**
- Multisample **34**
 - Select **35**
- Musical data **51, 52, 57, 61**
- Mute **30, 53**

N

- Name
 - Edit **19, 91**
- Notch filter **38**
- Note Number **20**

O

- Option **108**
- Overdub **57**
- Overwrite **57**

P

- Page
 - Select **16**
- Pan **40, 45, 55**
- Parameter **12, 17**
- Pattern **52, 61**
- PCG **87**
- Performance
 - Arpeggiator **4**
 - Chord trigger switch **21**
 - Drum Track **4**
 - RPPR **6**
- Pitch **37**
- Pitch bend **37**
- Pitch EG **38**
- Playback **53**
- Polyphony **34**
- Portamento **38**
- Power **23, 84**
- Power On Mode **84**
- Preload data **97**
- Program **27, 55, 73**
 - Edit **30, 34**
 - Effect **69**
 - Select **27, 45, 55**
 - Type **34**
- Protect **84**

R

- Realtime control **30**
- Realtime Control knob
 - Function **31**
- Realtime recording **57, 58**
- Rear panel **11**
- REC Resolution **56**
- Recording **55**
 - Auto Song Setup **60**
 - Control surface **61**
 - Multiple MIDI track **60**
 - Realtime **57, 58**
 - RPPR **64**
 - Step **58**
- REMS **iii**
- Rename **19, 91**
- Reset **21, 47**
 - Control surface **21**
 - Realtime control **31**
- Resonance **39**
- Restoring the factory setting **97**
- RPPR **6, 14, 61**

S

- Save **19, 87, 91**
 - Drum Kit **89**
 - Effect preset **70**
 - Global setting **89**
 - Program **33**
 - Realtime control **31**
 - Song **66**
 - Template song **66**
 - User Arpeggio Pattern **89**
- SD card **11, 33, 46, 91**
- Select
 - Combination **3**
 - Effect **69**
 - Program **2**
 - Song **53, 55**
- Sequencer **51**
- Setup parameter **51, 57**
- Single Program **34**
- SNG **87**
- Software
 - Operating system **109**
- Solo **30, 47, 53**
- Song **51**
 - Create **55**
 - Edit **62**
 - Effect **71**
 - Playback **53**
 - Recording **55**
 - Select **53, 55**
- Specification **107**

Speed
 Arpeggiator 73
 LFO 72
 Playback 52

Split 48

Status 49, 55

Step recording 58

SW1, SW2 19

T

Tab 12

 Select 17

TAP TEMPO 21

Template song 56, 57

Tempo 56, 73, 79

Time signature 56, 61

Tone Adjust 50

 Assigned the parameter 32

Total effect 67, 70

Track 55

Transpose 50, 83

Tremolo 41

U

USB connector 11

V

VALUE controller 10

VALUE slider 21

Velocity 20

 Curve 83

Velocity crossfade 35, 48

Velocity split 35

Velocity Switch 48, 49

Vibrato 37

Volume 9, 30, 36, 40, 45, 53, 55

W

Waveform 36

Write 87

 Drum Kit 89

 Global setting 89

 Program, Combination 88

 User Arpeggio Pattern 89

Write/Save 19

IMPORTANT NOTICE TO CONSUMERS

This product has been manufactured according to strict specifications and voltage requirements that are applicable in the country in which it is intended that this product should be used. If you have purchased this product via the internet, through mail order, and/or via a telephone sale, you must verify that this product is intended to be used in the country in which you reside.

WARNING: Use of this product in any country other than that for which it is intended could be dangerous and could invalidate the manufacturer's or distributor's warranty.

Please also retain your receipt as proof of purchase otherwise your product may be disqualified from the manufacturer's or distributor's warranty.

KORG KORG INC.

4015-2 Yanokuchi, Inagi-city, Tokyo 206-0812 Japan