

WK-3200 WK-3700

USER'S GUIDE



GUIDELINES LAID DOWN BY FCC RULES FOR USE OF THE UNIT IN THE U.S.A. (not applicable to other areas).

NOTICE

This equipment has been tested and found to comply with the limits for a Class B digital device, pursuant to Part 15 of the FCC Rules. These limits are designed to provide reasonable protection against harmful interference in a residential installation. This equipment generates, uses and can radiate radio frequency energy and, if not installed and used in accordance with the instructions, may cause harmful interference to radio communications. However, there is no guarantee that interference will not occur in a particular installation. If this equipment does cause harmful interference to radio or television reception, which can be determined by turning the equipment off and on, the user is encouraged to try to correct the interference by one or more of the following measures:

- Reorient or relocate the receiving antenna.
- Increase the separation between the equipment and receiver.
- Connect the equipment into an outlet on a circuit different from that to which the receiver is connected.
- Consult the dealer or an experienced radio/TV technician for help.

FCC WARNING

Changes or modifications not expressly approved by the party responsible for compliance could void the user's authority to operate the equipment.

Important!

Please note the following important information before using this product.

- Before using the optional AD-5 Adaptor to power the unit, be sure to check the AC Adaptor for any damage first. Carefully check the power cord for breakage, cuts, exposed wire and other serious damage. Never let children use an AC adaptor that is seriously damaged.
- Never attempt to recharge batteries.
- Do not use rechargeable batteries.
- Never mix old batteries with new ones.
- Use recommended batteries or equivalent types.
- Always make sure that positive (+) and negative (-) poles are facing correctly as indicated near the battery compartment.
- Replace batteries as soon as possible after any sign they are getting weak.
- Do not short-circuit the battery terminals.
- The product is not intended for children under 3 years.
- Use only CASIO AD-5 adaptor.
- The AC adaptor is not a toy.
- Be sure to disconnect the AC adaptor before cleaning the product.



This mark applies in EU countries only.



CASIO Europe GmbH
Bornbarch 10, 22848 Norderstedt, Germany

Safety Precautions

Congratulations on your selection of the CASIO electronic musical instrument.

- Before using the instrument, be sure to carefully read through the instructions contained in this manual.
- Please keep all information for future reference.

Symbols

Various symbols are used in this user's guide and on the product itself to ensure that the product is used safely and correctly, and to prevent injury to the user and other persons as well as damage to property. Those symbols along with their meanings are shown below.

DANGER

This symbol indicates information that, if ignored or applied incorrectly, creates the danger of death or serious personal injury.

WARNING

This indication stipulates matters that have the risk of causing death or serious injury if the product is operated incorrectly while ignoring this indication.

CAUTION

This indication stipulates matters that have the risk of causing injury as well as matters for which there is the likelihood of occurrence of physical damage only if the product is operated incorrectly while ignoring this indication.

Symbol Examples



This triangle symbol (\triangle) means that the user should be careful. (The example at left indicates electrical shock caution.)



This circle with a line through it (\odot) means that the indicated action must not be performed. Indications within or nearby this symbol are specifically prohibited. (The example at left indicates that disassembly is prohibited.)



The black dot (\bullet) means that the indicated action must be performed. Indications within this symbol are actions that are specifically instructed to be performed. (The example at left indicates that the power plug must be unplugged from the electrical socket.)

DANGER

Alkaline Batteries

Perform the following steps immediately if fluid leaking from alkaline batteries ever gets into your eyes. 

1. Do not rub your eyes! Rinse them with water.
2. Contact your physician immediately. Leaving alkaline battery fluid in your eyes can lead to loss of sight.

WARNING



Smoke, Strange Odor, Overheating

Continued use of the product while it is emitting smoke, a strange odor, or heat creates the risk of fire and electric shock. Take the following steps immediately.



1. Turn off power.
2. If you are using the AC adaptor for power, unplug it from the wall outlet.
3. Contact your original retailer or an authorized CASIO Service Provider.

AC Adaptor

● Misuse of the AC adaptor creates the risk of fire and electric shock. Always make sure you observe the following precautions.

- Be sure to use only the AC adaptor that is specified for this product. 
- Use only a power source whose voltage is the within the rating marked on the AC adaptor.
- Do not overload electrical outlets and extension cords. 

● Misuse of the AC adaptor's electric cord can damage or break it, creating the risk of fire and electric shock. Always make sure you observe the following precautions.

- Never place heavy objects on the cord or subject it to heat. 
- Never try to modify the cord or subject it to excessive bending.
- Never twist or stretch the cord.
- Should the electric cord or plug become damaged, contact your original retailer or authorized CASIO Service Provider. 

● Never touch the AC adaptor while your hands are wet.

Doing so creates the risk of electric shock.

● Use the AC adaptor where it will not be splashed with water. Water creates the risk of fire and electric shock. 

● Do not place a vase or any other container filled with liquid on top of the AC adaptor. Water creates the risk of fire and electric shock. 

Batteries

Misuse of batteries can cause them to leak, resulting in damage to nearby objects, or to explode, creating the risk of fire and personal injury. Always make sure you observe the following precautions.

- Never try to take batteries apart or allow them to become shorted. 
- Never expose batteries to heat or dispose of them by incineration.
- Never mix old batteries with new ones.
- Never mix batteries of different types.
- Do not charge the batteries.
- Make sure the positive (+) and negative (-) ends of the batteries are facing correctly.

Do not incinerate the product.

Never throw the product into fire.

Doing so can cause it to explode, creating the risk of fire and personal injury. 

Water and Foreign Matter

Water, other liquids, and foreign matter (such as pieces of metal) getting into the product create the risk of fire and electric shock. Take the following steps immediately. 

1. Turn off power.
2. If you are using the AC adaptor for power, unplug it from the wall outlet.
3. Contact your original retailer or an authorized CASIO Service Provider.

Disassembly and Modification

Never try to take this product apart or modify it in any way. Doing so creates the risk of electric shock, burn injury, or other personal injury. Leave all internal inspection, adjustment, and maintenance up to your original retailer or authorized CASIO Service Provider. 



Dropping and Impact

Continued use of this product after it has been damaged by dropping or subjecting it to strong impact creates the risk of fire and electric shock. Take the following steps immediately.



1. Turn off power.
2. If you are using the AC adaptor for power, unplug it from the wall outlet.
3. Contact your original retailer or an authorized CASIO Service Provider.

Plastic Bags

Never place the plastic bag the product comes in over your head or in your mouth. Doing so creates the risk of suffocation. Particular care concerning this precaution is required where small children are present.



Keep off of the product and stand.*

Climbing onto the product or stand can cause it to tip over or become damaged. Particular care concerning this precaution is required where small children are present.



Location

Avoid locating the product on an unstable stand, on an uneven surface, or any other unstable location. An unstable location can cause the product to fall over, creating the risk of personal injury.



CAUTION

AC Adaptor

- Misuse of the AC adaptor creates the risk of fire and electric shock. Always make sure you observe the following precautions.
 - Do not locate the electric cord near a stove or other sources of heat.
 - Never pull on the cord when unplugging from the electrical outlet. Always grasp the AC adaptor when unplugging.
- Misuse of the AC adaptor creates the risk of fire and electric shock. Always make sure you observe the following precautions.
 - Insert the AC adaptor into the wall outlet as far as it will go.
 - Unplug the AC adaptor from the wall outlet during lightening storms or before leaving on a trip or other long-term absence.
 - At least once a year, unplug the AC adaptor from the wall outlet and wipe away any dust that is built up in the area around the prongs of the plug.



Relocating the Product

Before relocating the product, always unplug the AC adaptor from the wall outlet and disconnect all other cables and connecting cords. Leaving cords connected creates the risk of damage to the cords, fire, and electric shock.



Cleaning

Before cleaning the product, always unplug the AC adaptor from the wall outlet first. Leaving the AC adaptor plugged in creates the risk of damage to the AC adaptor, fire, and electric shock.



Batteries

Misuse of batteries can cause them to leak resulting in damage to nearby objects, or to explode, creating the risk of fire and personal injury. Always make sure you observe the following precautions.

- Use only batteries that are specified for use with this product.
- Remove batteries from the product if you do not plan to use it for a long time.

Connectors

Connect only the specified devices and equipment to the product's connectors. Connection of a non-specified device or equipment creates the risk of fire and electric shock.



Location

Avoid the following locations for this product. Such locations create the risk of fire and electric shock.



- Areas subject to high humidity or large amounts of dust.
- In food preparation areas or other areas subject to oil smoke.
- Near air conditioning equipment, on a heated carpet, in areas exposed to direct sunlight, inside of a vehicle parked in the sun, or any other area that subjects the product to high temperatures.

Display Screen

- Never push on the display screen's LCD panel or subject it to strong impact. Doing so can cause the LCD panel's glass to crack, creating the risk of personal injury.
- Should the LCD panel ever crack or break, never touch the liquid inside of the panel. LCD panel liquid can cause skin irritation.
- Should LCD panel liquid ever get inside your mouth, immediately wash out your mouth with water and contact your physician.
- Should LCD panel liquid ever get into your eyes or onto your skin, rinse with clear water for at least 15 minutes, and then contact a physician.



Sound Volume

Do not listen to music at very loud volumes for long periods. Particular care concerning this precaution is required when using headphones. High volume settings can damage your hearing.



Heavy Objects

Never place heavy object on top of the product. Doing so can make the product top heavy, causing the product to tip over or the object to fall from it, creating the risk of personal injury.



Correct Stand* Assembly

An incorrectly assembled stand can tip over, causing the product to fall and creating the risk of personal injury.



Make sure you assemble the stand correctly, following the assembly instructions that come with it. Make sure you mount the product on the stand correctly.

* Stand is available as an option.

IMPORTANT!

When using batteries, be sure to replace them or shift to one of the alternate power sources whenever you notice any of the following symptoms.

- Dim power indicator
- Instrument does not turn on
- Display that is flickering, dim, or difficult to read
- Abnormally low speaker/headphone volume
- Distortion of sound output
- Occasional interruption of sound when playing at high volumes
- Sudden power failure when playing at high volumes
- Flickering or dimming of the display when playing at high volume
- Continued sound output even after you release a key
- A tone that is totally different from the one that is selected
- Abnormal rhythm pattern and demo tune play
- Loss of power, sound distortion, or low volume when playing from a connected computer or MIDI device
- Sudden power failure while reading from or writing to external storage media



Introduction

Congratulations upon your selection of this CASIO musical instrument. This keyboard provides you with the following features and functions.

❑ 550 Tones Include Rich Advanced Tones

A total of 332 Advanced Tones are programmed with DSP tones to make them richer and more powerful. Advanced tones like Stereo Piano and Tremolo Electric Piano enhance the Piano and Electric Piano tones to create a totally new sound.

❑ 50 Drawbar Organ Tones

In addition to the 550 standards tones, the keyboard also includes 50 realistic drawbar organ tones. Drawbar organ tones can be controlled using nine digital drawbars. You can also select percussion or key click, and even edit the parameters of preset tone and save up to 100 original tones in user tone memory.

❑ Flash Memory

Built-in Flash memory lets you expand your selection of tones and rhythms by downloading data from the CASIO MUSIC SITE, or by the CD-ROM that comes bundled with the keyboard. You can also store up to 200 SMF format music files for playback.

❑ PIANO SETTING Button

The press of a button optimizes the keyboard setup for piano play.

❑ 160 Preset Rhythms + 16 User Rhythms

A selection of 160 rhythms includes accompaniments for everything from rock to pops and jazz. You can also transfer accompaniment data from your computer and store up to 16 of them as user rhythms in keyboard memory.

❑ Auto Accompaniment

Simply play a chord and the corresponding rhythm, bass and chord parts play automatically. One-touch Preset instantly recalls the most suitable tone and tempo settings to match the rhythm you are using.

❑ Big, Information-packed Display

A big built-in display shows chord names, tempo setting, keyboard information, staff notation of notes played, and more for full support of all your keyboard play. A built-in backlight keeps the display easy to read, even in total darkness.

❑ Song Memory

Record up to six parts in memory, along with their tone, volume, pan position, and other parameters for later playback. Realistic ensemble play can also be created using the Auto Accompaniment function.

❑ Synthesizer Mode

Edit built-in sounds to produce your own original creations. Up to 120 of your own sounds can be stored in memory for recall, just like the built-in tones.

❑ General MIDI compatibility

The General MIDI tones of this keyboard let you connect to a personal computer to enjoy “desktop music” capabilities. This keyboard can be used as a desktop music input device or sound source, and it's just the thing for playback of commercially available pre-recorded General MIDI music software.

❑ Powerful effects

A collection of powerful effects, such as DSP reverb, chorus, and more, give you total control over the type of sound you want. You can even change the parameters of an effect to create your own, original effects. A 4-band equalizer is also included.



Mixer

You can specify tone, volume, pan position, and other parameters for each built-in Auto Accompaniment part. You can also control the same parameters for each channel during MIDI input.

Registration Memory

Keyboard setups can be stored in memory for later recall and instant settings whenever you need them. Up to 32 setups (4 setups x 8 banks) can be stored in registration memory.

Data download from your computer

You can use your computer to download data from the CASIO MUSIC SITE.

SmartMedia™ Card Slot

A built-in SmartMedia card slot helps to simplify transfer of data from a computer and lets you store volumes of data for later recall when you need it. You can also load a card with a standard MIDI file (SMF) and play it back on the keyboard.

Built-in floppy disk drive (WK-3700 only)

Save original tones or songs you created with the Song Memory to disk for long-term storage. You can also load a disk with a standard MIDI file (SMF) and play it back on the keyboard.



Contents

Safety Precautions E-1

Introduction E-5

General Guide E-10

Attaching the Score Stand E-11

Playing a Demo Tune E-12

Power Supply E-14

Using batteries E-14

Using the AC Adaptor E-15

Auto Power Off E-15

Turning Off the Keyboard E-16

Memory Contents E-16

Connections E-17

Basic Operations E-19

To play the keyboard E-19

Selecting a Tone E-19

PIANO SETTING Button E-20

Using the PITCH BEND Wheel E-21

Using the MODULATION E-21

Using the Drawbar Organ

Mode E-22

To select a drawbar organ tone E-24

To edit a drawbar organ tone E-24

Parameter Details E-25

To save an edited drawbar organ tone ... E-26

Applying Effects to Tones E-27

Effect Blocks E-27

Selecting a DSP Type E-28

About the DSP Button E-29

Selecting REVERB E-29

Selecting CHORUS E-30

Using the Equalizer E-31

Auto Accompaniment E-32

About the MODE Button E-32

Selecting a Rhythm E-32

Playing a Rhythm E-33

Adjusting the Tempo E-33

Using Auto Accompaniment E-33

Using an Intro Pattern E-36

Using a Fill-in Pattern E-36

Using a Rhythm Variation E-37

Synchro Starting Accompaniment
with Rhythm Play E-37

Finishing with an Ending Pattern E-37

Using One-touch Preset E-38

Using Auto Harmonize E-38

Adjusting the Accompaniment Volume ... E-39

Mixer Function E-40

What you can do with the Mixer E-40

Turning Channels On and Off E-40

Using the Parameter Edit Mode E-41

How Parameters Work E-42



Synthesizer Mode E-44

- Synthesizer Mode Functions E-44
- Creating a User Tone E-47
- Storing a User Tone In Memory E-50

Registration Memory E-51

- Registration Memory Features E-51
- To Save a Setup in Registration Memory E-52
- To Recall a Setup from Registration Memory E-52

Song Memory Function E-53

- Tracks E-53
- Basic Song Memory operations E-53
- Using Real-time Recording E-54
- Mixer Mode Settings E-55
- Playing Back from Song Memory E-56
- Recording Melody and Chords with Step Recording E-56
- Recording Multiple Tracks E-59
- Correcting Mistakes While Step Recording E-60
- Editing Memory Contents E-62
- Editing a Song E-64

Keyboard Settings E-65

- Using Layer E-65
- Using Split E-66
- Using Layer and Split Together E-67
- Transposing the Keyboard E-68
- Using Touch Response E-68
- Tuning the Keyboard E-69
- Changing Other Settings E-70

Using the SMF Player E-74

- Playing Back an SMF E-76
- Configuring Other Settings E-77

MIDI E-79

- What is MIDI? E-79
- General MIDI E-79
- MIDI Settings E-79
- Using the Music Data Management Software (on the Bundled CD-ROM) E-80



Saving Data E-82

Using a SmartMedia Card E-83

Using the Floppy Disk Drive
(WK-3700 Only) E-84

Using External Storage Media E-86

Saving Files E-87

Loading a File E-88

Renaming a File E-90

Deleting a File E-90

Formatting External Storage Media E-91

Inputting Characters E-92

SmartMedia Card Error Messages E-93

Disk Drive Error Messages
(WK-3700 Only) E-94

Troubleshooting E-95

Specifications E-98

Care of your Instrument ... E-101

Appendix A-1

Tone List A-1

Drum Assignment List A-9

Rhythm List A-11

Fingered Chord Chart A-12

Effect List A-14

DSP Algorithm List A-16

MIDI Implementation Chart

Company and product names used in this manual may be registered trademarks of others.

General Guide

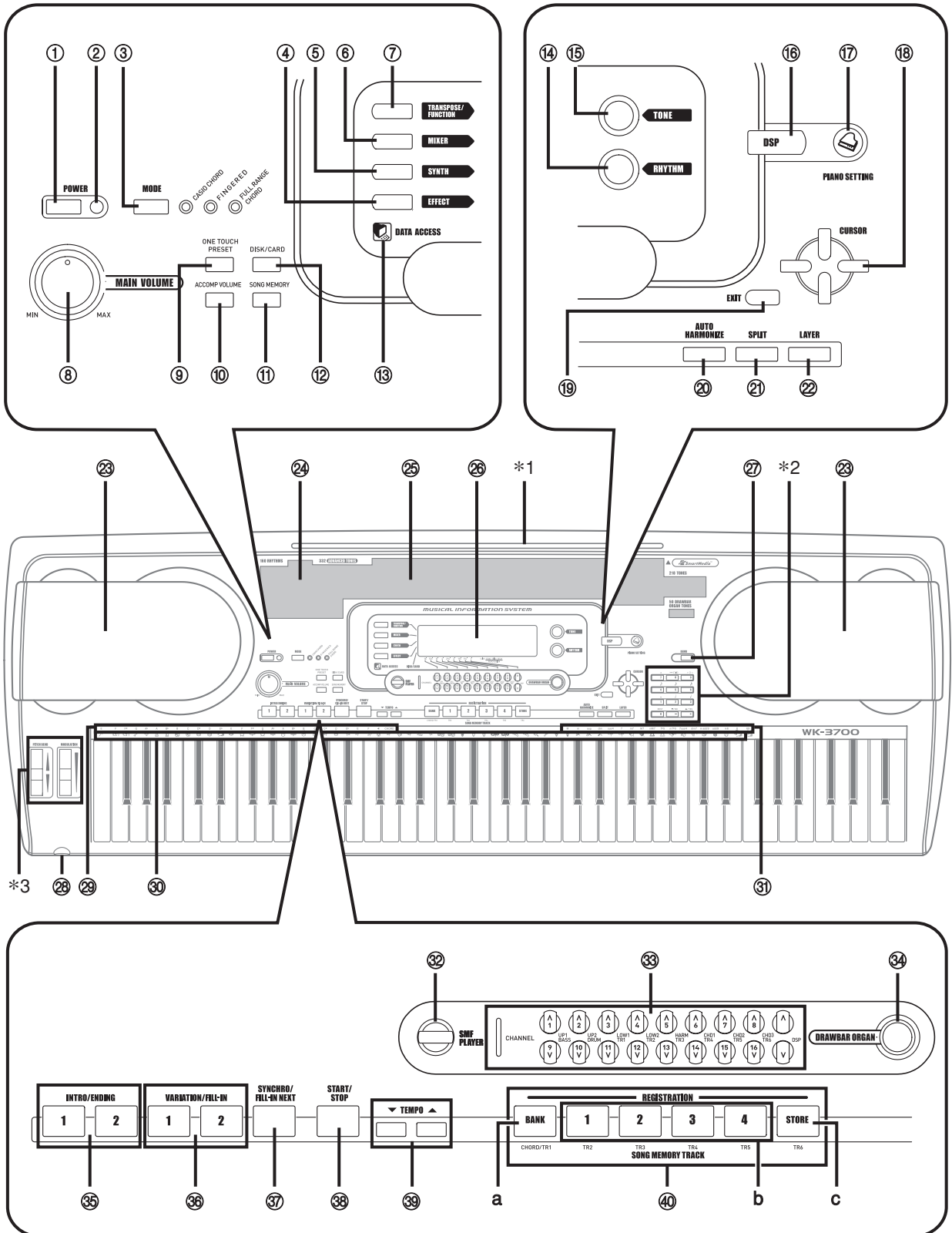



• Illustrations in this User's Guide shows the WK-3700.

- ① POWER button
- ② Power indicator
- ③ MODE button
- ④ EFFECT button
- ⑤ SYNTH button
- ⑥ MIXER button
- ⑦ TRANSPOSE/FUNCTION button
- ⑧ MAIN VOLUME knob
- ⑨ ONE TOUCH PRESET button
- ⑩ ACCOMP VOLUME button
- ⑪ SONG MEMORY button
- ⑫ ●WK-3700
DISK/CARD button
●WK-3200
CARD button
- ⑬ DATA ACCESS lamp
- ⑭ RHYTHM button
- ⑮ TONE button
- ⑯ DSP button
- ⑰ PIANO SETTING button
- ⑱ [▲]/[▼]/[◀]/[▶] CURSOR buttons
- ⑲ EXIT button
- ⑳ AUTO HARMONIZE button
- ㉑ SPLIT button
- ㉒ LAYER button
- ㉓ Speaker
- ㉔ Rhythm list
- ㉕ Tone list
- ㉖ Display
- ㉗ DEMO button*4
- ㉘ ●WK-3700
PHONES terminal
●WK-3200
PHONES/OUTPUT terminal
- ㉙ CHORD root names
- ㉚ Percussion instrument list
- ㉛ Chord types name
- ㉜ SMF PLAYER button
- ㉝ CHANNEL button(1~16, DSP)/drawbar buttons
- ㉞ DRAWBAR ORGAN button
- ㉟ INTRO/ENDING 1/2 buttons
- ㊱ VARIATION/FILL-IN 1/2 buttons
- ㊲ SYNCHRO/FILL-IN NEXT button
- ㊳ START/STOP button
- ㊴ TEMPO buttons
- ㊵ SONG MEMORY TRACK buttons
 - a) BANK button
 - b) REGISTRATION buttons
 - c) STORE button

Attaching the Score Stand*1

Insert the score stand into the slot at the top of the keyboard as shown in the illustration.

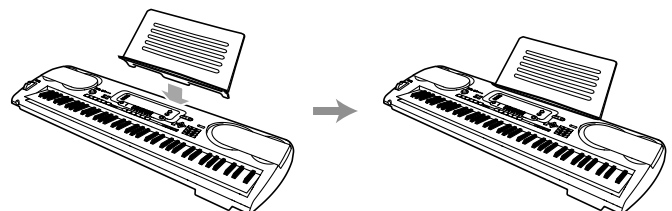

*2

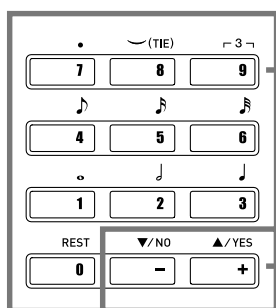

④① Number buttons

④② [+]/[-] buttons
(YES/NO)

- For input of numbers to change displayed settings.
- Negative values can be changed only by using [+] and [-] to increment and decrement the displayed value.

*3

• WK-3700

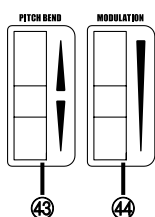

- ④③ PITCH BEND wheel
- ④④ MODULATION wheel

• WK-3200

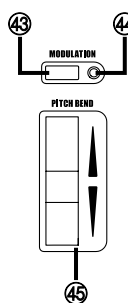

- ④③ MODULATION button
- ④④ MODULATION button lamp
- ④⑤ PITCH BEND wheel

Playing a Demo Tune*4

Pressing the DEMO button starts demo tune play. There are 3 demo tunes, which continuously play in sequence. To stop demo tune play, press either the DEMO button or the START/STOP button.

NOTE

- Pressing the [+]/[-] buttons skips to the next demo tune.
- The PIANO SETTING button, Layer, and Split are disabled while a demo tune is playing.

Front Panel

• WK-3700 only

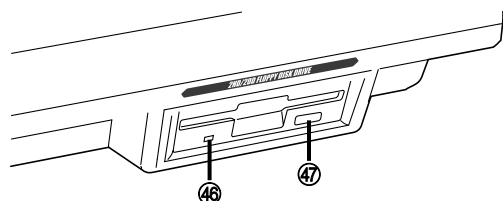

④⑥ Access lamp

④⑦ Eject button

Rear Panel

• WK-3700

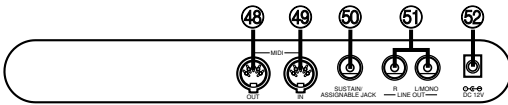

- ④⑧ MIDI OUT terminal
- ④⑨ MIDI IN terminal
- ⑤⑩ SUSTAIN/ASSIGNABLE JACK terminal
- ⑤① LINE OUT R, LINE OUT L/MONO terminal
- ⑤② DC 12V terminal

• WK-3200

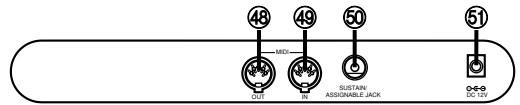

- ④⑧ MIDI OUT terminal
- ④⑨ MIDI IN terminal
- ⑤⑩ SUSTAIN/ASSIGNABLE JACK terminal
- ⑤① DC 12V terminal

Rear Panel

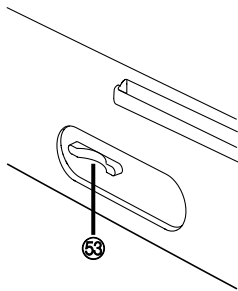

⑤③ Card slot

NOTE

- Display examples shown in this User's Guide are intended for illustrative purposes only. The actual text and values that appear on the display may differ from the examples shown in this User's Guide.
- Due to LCD element characteristics, display contrast changes depending on the angle from which you view it. The initial default contrast setting is one that allows easy viewing for a musician seated directly in front of the display. You can also adjust the contrast to the level that suits your particular needs. For more information, see page E-73.

Power Supply

This keyboard can be powered by current from a standard household wall outlet (using the specified AC adaptor) or by batteries. Always make sure you turn the keyboard off whenever you are not using it.

Using batteries

Always make sure you turn off the keyboard before loading or replacing batteries.

To load batteries

- 1 Remove the battery compartment cover.

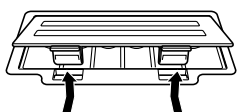

- 2 Load six D-size batteries into the battery compartment.
 - Make sure that the positive (+) and negative (-) ends are facing correctly.

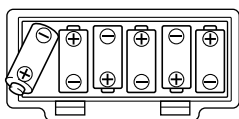

- 3 Insert the tabs on the battery compartment cover into the holes provided and close the cover.

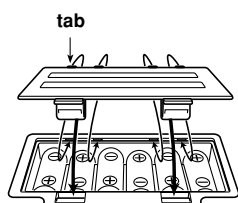

NOTE

- The keyboard may not function correctly if you load or replace batteries with power turned on. If this happens, turning the keyboard off and then back on again should return functions back to normal.

Important Battery Information

- The following shows the approximate battery life.

Alkaline batteries 4 hours

The above value is standard battery life at normal temperature, with the keyboard volume at a medium setting. Temperature extremes or playing at very loud volume settings can shorten battery life.

⚠ WARNING

Misuse of batteries can cause them to leak, resulting in damage to nearby objects, or to explode, creating the risk of fire and personal injury. Always make sure you observe the following precautions.

- Never try to take batteries apart or allow them to become shorted. ⓧ
- Never expose batteries to heat or dispose of them by incineration.
- Never mix old batteries with new ones.
- Never mix batteries of different types.
- Do not charge the batteries.
- Make sure the positive (+) and negative (-) ends of the batteries are facing correctly.

⚠ CAUTION

Misuse of batteries can cause them to leak resulting in damage to nearby objects, or to explode, creating the risk of fire and personal injury. Always make sure you observe the following precautions.

- Use only batteries that are specified for use with this product. ⓧ
- Remove batteries from the product if you do not plan to use it for a long time.

Using the AC Adaptor

Make sure that you use only the AC adaptor specified for this keyboard.

Specified AC Adaptor: AD-12

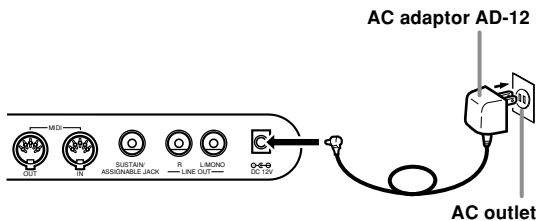

Note the following important precautions to avoid damage to the power cord.

● During Use

- Never pull on the cord with excessive force.
- Never repeatedly pull on the cord.
- Never twist the cord at the base of the plug or connector.
- The power cord should not be stretched tight while it is in use.

● During Movement

- Before moving the keyboard, be sure to unplug the AC adaptor from the power outlet.

● During Storage

- Loop and bundle the power cord, but never wind it around the AC adaptor.

IMPORTANT!

- Make sure that the keyboard is turned off before connecting or disconnecting the AC adaptor.
- Using the AC adaptor for a long time can cause it to become warm to the touch. This is normal and does not indicate malfunction.

Auto Power Off

When you are using battery power, keyboard power turns off automatically whenever you leave it on without performing any operation for about 6 minutes. When this happens, press the POWER button to turn power back on.

NOTE

- Auto Power Off is disabled (it does not function) when you are using the AC adaptor to power the keyboard.

To disable Auto Power Off

Hold down the TONE button while turning on the keyboard to disable Auto Power Off.

- When Auto Power Off is disabled, the keyboard does not turn off automatically no matter how long it is left with no operation being performed.
- Auto Power Off is automatically enabled whenever you turn on keyboard power.

Settings

Tone, rhythm, and other “main keyboard settings” in effect when you turn off the keyboard manually by pressing POWER button or when Auto Power Off turns off power are still in effect the next time you turn power back on.

Main Keyboard Settings

Tone number, layer, split, split point, drawbar organ tone settings, transpose, tuning, and contrast settings, touch response, reverb, chorus, DSP, equalizer, rhythm number, tempo, keyboard channel, MIDI In Chord Judge on/off, accomp MIDI out on/off, assignable jack setting, accompaniment volume, user area tones (Synthesizer Mode), user area accompaniments, user DSP area, pitch bend range, Auto Harmonize on/off, Auto Harmonize type, Mixer hold, DSP hold, Auto Accompaniment mode, all Mixer parameters, all Synthesizer Mode parameters, Song Memory song numbers, SMF player settings (play mode, manual play part, SMF playback volume)

Turning Off the Keyboard

- Be sure to press the POWER button to turn off power and make sure that the LCD backlight is off before disconnecting the AC adaptor or doing anything else.
- Never disconnect the AC adaptor while the keyboard is turned on or try to turn off power using any other technique besides pressing the POWER button. Doing so can cause the contents of the keyboard's Flash memory to become corrupted. Strange keyboard operation and abnormal startup when power is turned on are symptoms of corrupted Flash memory contents. See "Troubleshooting" on page E-95 for more information.

IMPORTANT!

- While the following message is on the display, never turn off the keyboard by pressing the POWER button, disconnecting the AC adaptor, etc.

(message) "Pls Wait" or "Bulk In"

Turning off the keyboard while the above message is on the display can cause user data (user tones, song memory data, etc.) currently stored in keyboard memory or on external media to become corrupted. Once corrupted, you may not be able to recall the data again.

Memory Contents

In addition to the above settings, data stored in the Registration Mode and Song Memory Mode is also retained when keyboard power is turned off.

Saving Setups and Memory Contents

About Flash memory

Your keyboard comes with built-in Flash memory, which can continue to hold data even when electrical power is totally cut off. This means that even after batteries go completely dead, you can attach the AC adaptor, turn on power, and still recall data stored in memory.

You can back up keyboard memory contents and other data using the media described below.

- SmartMedia™ Card
See "Using a SmartMedia Card" on page E-83.
- Floppy Diskette (WK-3700 only)
See "Using the Floppy Disk Drive (WK-3700 Only)" on page E-84.
- Computer hard disk
See "MIDI" on page E-79.

IMPORTANT!

- When running under battery power, be sure to replace batteries as soon as possible after the first signs of low battery power (dim power indicator lamp, dim display characters, etc.) Though the keyboard's Flash memory is non-volatile (which means that data is not lost when power is interrupted), data can be lost if power suddenly fails while data is being written to flash memory*.
 - * While storing or deleting user data, while recording with the synthesizer, while transferring data from a computer, etc.

Initializing the Keyboard

Initialization can be used to return keyboard parameters to their initial factory default settings, or to delete all data currently in keyboard memory. See page E-73 for more information about initialization.

Returning the keyboard to its initial factory defaults

You can use the CD-ROM that comes with the keyboard and your computer to return the keyboard's flash memory and all of its parameters to their initial factory default settings. See "Bundled CD-ROM Data" on page E-80 for details.

Connections

• WK-3700

Phones and Line Out Terminals

Before connecting phones or other external equipment, be sure to first turn down the volume settings of the keyboard and the connected equipment. You can then adjust volume to the desired level after connections are complete.

[Front]

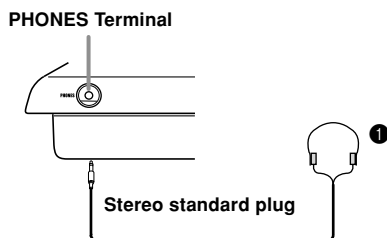

Connecting Phones 1

Connecting phones cuts off output from the keyboard's built-in speakers, so you can play even late at night without disturbing anyone.

[Rear Panel]

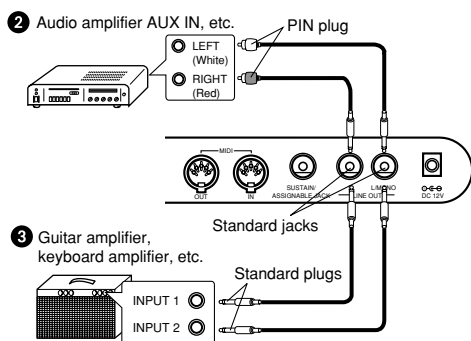

Connecting to Audio Equipment 2

Use commercially available cords to connect to the two jacks as shown in Figure 2. It is up to you to purchase connecting cables like the ones shown in the illustration for connection. Normally in this configuration, you must set the audio equipment's input selector to the setting that specifies the terminal (such as AUX IN) that the keyboard is connected to. Use the keyboard's MAIN VOLUME knob to adjust the volume level.

Connecting to a Musical Instrument Amplifier 3

Use commercially available cords to connect to the two jacks as shown in Figure 3. It is up to you to purchase connecting cables like the ones shown in the illustration for connection. Use the keyboard's MAIN VOLUME knob to adjust the volume level.

- If your amplifier has only one input jack, connect a cord to the L/MONO jack only.

NOTE

- You can also connect the keyboard's MIDI terminal to a computer or sequencer. See "MIDI" on page E-79 for details.

• WK-3200

Phones/Output Terminal

Before connecting phones or other external equipment, be sure to first turn down the volume settings of the keyboard and the connected equipment. You can then adjust volume to the desired level after connections are complete.

[Front]

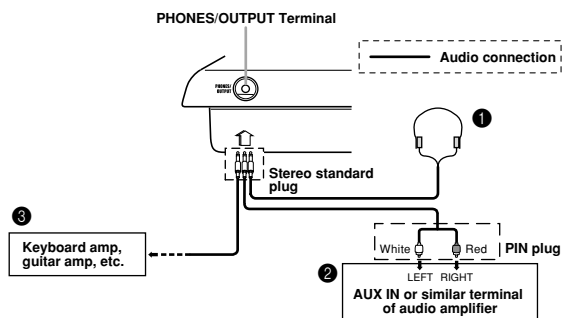

Connecting Phones 1

Connecting phones cuts off output from the keyboard's built-in speakers, so you can play even late at night without disturbing anyone.

Audio Equipment 2

Connect the keyboard to a audio equipment using a commercially available connecting cord with a standard plug on one end and two PIN plugs on the other end. Note that the standard plug you connect to the keyboard must be a stereo plug, otherwise you will be able to output only one of stereo channels. In this configuration, you normally set the input selector of the audio equipment to the terminal (usually marked AUX IN or something similar) where the cord from the keyboard is connected. See the user documentation that comes with your audio equipment for full details.

Musical Instrument Amplifier ③

Use a commercially available connecting cord to connect the keyboard to a musical instrument amplifier.

NOTE

- Be sure to use a connecting cord that has a stereo standard plug on the end you connect to the keyboard, and a connector that provides dual channel (left and right) input to the amplifier to which you are connecting. The wrong type of connector at either end can cause one of the stereo channels to be lost.
- When connected to a musical instrument amplifier, set the volume of the keyboard to a relatively low level and make output volume adjustments using the amplifier's controls.

Connection Example

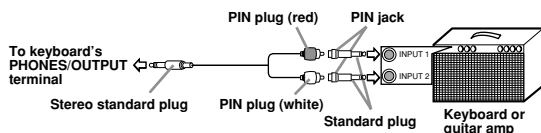

NOTE

- You can also connect the keyboard to a computer or sequencer. See "MIDI" on page E-79 for details.

Sustain/Assignable jack Terminal

You can connect an optional sustain pedal (SP-3 or SP-20) to the SUSTAIN/ASSIGNABLE JACK terminal to enable the capabilities described below.

For details on how to select the pedal function you want, see "Changing Other Settings" on page E-70.

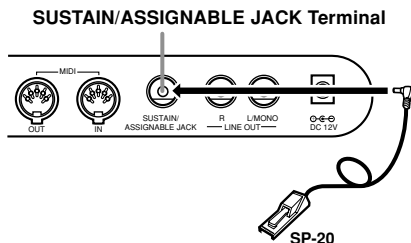

Sustain Pedal

- With piano tones, depressing the pedal causes notes to linger, much like a piano's damper pedal.
- With organ tones, depressing the pedal causes notes to continue to sound until the pedal is released.

Sostenuto Pedal

- As with the sustain pedal function described above, depressing the sostenuto pedal causes notes to be sustained.
- This difference between a sostenuto and sustain pedal is the timing. With a sostenuto pedal, you press the keys and then depress the pedal before you release the keys. Only the notes that are sounding when the pedal is depressed are sustained.

Soft Pedal

Depressing the pedal softens the sound of the notes being played.

Rhythm Start/Stop Pedal

In this case, the pedal performs the same functions as the START/STOP button.

Accessories and Options

Use only the accessories and options specified for this keyboard. Use of non-authorized items creates the danger of fire, electrical shock, and personal injury.

Basic Operations

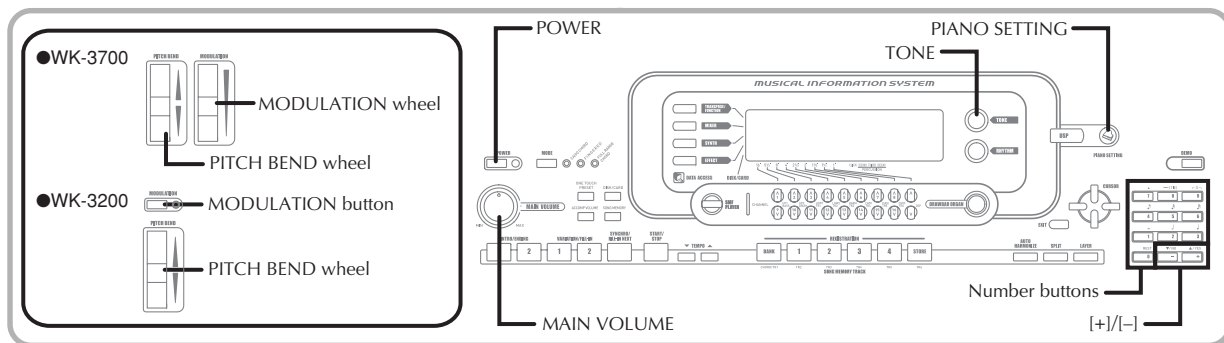

This section provides information on performing basic keyboard operations.

To play the keyboard

- 1 Press the POWER button to turn the keyboard on.
 - This causes the power indicator to light.
- 2 Use the MAIN VOLUME knob to set the volume to a relatively low level.
- 3 Play something on the keyboard.

Selecting a Tone

This keyboard comes with tones built-in, as shown below.

A partial list of the available tone names is printed on the keyboard console. See the “Tone List” on page A-1 of this manual for a complete list. “Advanced Tones”, are variations of standard tones, which are created by programming in effects (DSP) and other settings.

For details about drawbar organ tones, see “Using the Drawbar Organ Mode” on page E-22.

Tone Types

Standard Tones: 550 Preset Tones + 124 User Tones

Number	Number of Tones	Tone Type	DSP Line On/Off*1
000 - 331	332	Advanced Tones	On
400 - 599	200	Preset Tones	Off
600 - 617	18	Drum Sets	Off
700 - 799	100	User Tones*2	On/Off*3
800 - 819	20	User Tones with Waves*4	On/Off*3
900 - 903	4	User Drum Sets with Waves*4	On/Off*5

Drawbar Organ Tones: 50 Preset Tones + 100 User Tones

Number	Number of Tones	Tone Type	DSP Line On/Off*1
000 - 049	50	Preset Tones	On/Off*5
100 - 199	100	User Tones*6	On/Off*3

*1: See “Changing Tones and Configuring DSP Effect Settings” on page E-20.

*2: Memory area for tones created by you. See “Synthesizer Mode” on page E-44. User tone areas 700 through 799 initially contain the same data as advanced tones 000 through 099.

*3: Depends on source tone or user setting. See “Synthesizer Mode” on page E-44 for more information.

*4: Area for data transferred from a computer. See “Using the Music Data Management Software (on the Bundled CD-ROM)” on page E-80 for more information. For information about waveforms, see “Creating a User Tone” on page E-47.

*5: Depends on tone. This status can be checked by viewing the DSP button. See “About the DSP Button” on page E-29 for more information.

*6: Memory area for tones created by you. See “To edit a drawbar organ tone” on page E-24. User drawbar organ tone areas initially contain two sets of the same data as drawbar organ tones types 000 through 049.

NOTE

- You cannot select tone numbers not included in the above range (standard tones 332 through 399, 618 through 699 and 820 through 899, and drawbar organ tones from 050 to 099). When you use the [+] and [-] buttons to scroll through tone numbers, scrolling jumps across the unused numbers. Pressing [+] when 617 is selected, for example, jumps to 700.

To select a tone

- 1 Find the tone you want to use in the tone list and note its tone number.
- 2 Press the TONE button.

TONE

- 3 Use the number buttons to input the three digit tone number for the tone you want to select.
Example: To select “432 GM ACOUSTIC BASS”, input 4, 3 and then 2.

TONE **432** AcousBsG

NOTE

- Always input all three digits for the tone number, including leading zeros (if any).
- You can also increment the displayed tone number by pressing [+] and decrement it by pressing [-].
- When one of the drum sets is selected (tone numbers 600 through 617), each keyboard key is assigned a different percussion sound. See page A-9 for details.

Polyphony

The term polyphony refers to the maximum number of notes you can play at the same time. The keyboard has 32-note polyphony, which includes the notes you play as well as the rhythms and auto-accompaniment patterns that are played by the keyboard. This means that when a rhythm or auto-accompaniment pattern is being played by the keyboard, the number of notes (polyphony) available for keyboard play is reduced. Also note that some of the tones offer only 10-note polyphony.

Changing Tones and Configuring DSP Effect Settings

This keyboard has only a single DSP sound source. Because of this, selecting tones for which DSP is enabled for multiple parts when layering or splitting tones (page E-65, 66) can cause conflicts. To avoid conflicts, DSP is allocated to the last DSP enabled tone, and DSP is disabled (DSP line OFF) for all other parts.

DSP line is a parameter that controls whether or not the currently selected DSP effect is applied to a part.* Each tone has a DSP line parameter. Selecting a tone for a part applies the tone’s DSP line parameter setting to all parts.

* The DSP line parameter is turned on (DSP effect is applied) for the 332 Advanced Tones numbered 000 through 331, and turned off (DSP effect not applied) for the 200 preset tones from 400 to 599. For information about other tones, see “Tone Types” on page E-19.

PIANO SETTING Button

Pressing this button changes the setup of the keyboard to optimize it for piano play.

Settings

Tone Number: “000”
 Rhythm Number: “140”
 Accompaniment Mode: Normal
 Layer: Off
 Split: Off
 Auto Harmonize: Off
 Transpose: 0
 Touch Response:
 Off: Returns to initial default
 On: No change
 Assignable Jack: SUS
 Local Control: On
 Mixer Channel 1 Parameter Setup: Depends on tone

To optimize keyboard settings for piano play

- 1 Press the PIANO SETTING button.
- 2 Now try playing something on the keyboard.
 - The notes you play will sound with a piano tone.
 - If you want to play with rhythm accompaniment, press the START/STOP button. This causes a rhythm that is optimized for piano will start to play.
 - To stop rhythm play, press the START/STOP button again.

NOTE

- Pressing the PIANO SETTING button while a rhythm is playing stops rhythm play and then changes the keyboard setup.
- Pressing the PIANO SETTING button while the keyboard is in the Synthesizer Mode or other mode exits the current mode and then changes the keyboard setup.
- The setup of the keyboard does not change if you press the PIANO SETTING button when any one of the following exists.
 - * During real-time recording, step recording, or while using the editing function of the Song Memory
 - * While the data save or overwrite message is on the display
 - * During demo tune play

Using the PITCH BEND Wheel

As its name suggests, the PITCH BEND wheel lets you “bend” the pitch of a sound. This makes it possible to add a touch of realism to saxophone and other tones.

To use the PITCH BEND wheel

- 1 While holding down a keyboard key with your right hand, use your left hand to rotate the PITCH BEND wheel up and down.
 - Releasing the PITCH BEND wheel returns the note to its original pitch.

NOTE

- With saxophone and electrical guitar tones, the most realistic sounding effects can be produced if you play notes and operate the PITCH BEND wheel simultaneously.
- See “Pitch Bend Range (Initial Default: 12)” on page E-73 for changing the bend range of the PITCH BEND wheel.
- Never turn on keyboard power while the PITCH BEND wheel is rotated.

Using the MODULATION

Modulation applies vibrato, which modulates the pitch of a note. It works best with notes that are sustained (held) by keeping a keyboard key held down, especially when playing the melody with a violin or other similar tone. You can modify the modulation effect using DSP parameter 0 through 7. For more information, see “DSP Parameters” on page E-28.

• WK-3700**To use the MODULATION Wheel**

- 1 While playing melody notes with your right hand, rotate the MODULATION wheel with your left hand to apply vibrato to the notes.
 - The amount of vibrato applied depends on how far you rotate the MODULATION wheel upwards. Setting the wheel to its neutral position (rotated as far downwards as it can go) turns vibrato off.

• WK-3200**To use the MODULATION button**

- 1 While holding down a keyboard key with your right hand, use your left hand to press the MODULATION button.
 - Vibrato is applied as long as the MODULATION button is depressed.

NOTE

- Modulation can be used to add greater expression to sustained melody notes being played using a violin, synthetic reed, or other similar tone.
- Modulation affects different tones in different ways.

Using the Drawbar Organ Mode

Your keyboard has built-in “drawbar organ tones” that can be altered using nine digital drawbars whose operations are similar to the controls on a drawbar organ. You can also select percussion or key click. There is room in memory for storage of up to 100 user-created drawbar tone variations.

Drawbar Organ Mode Operational Flow

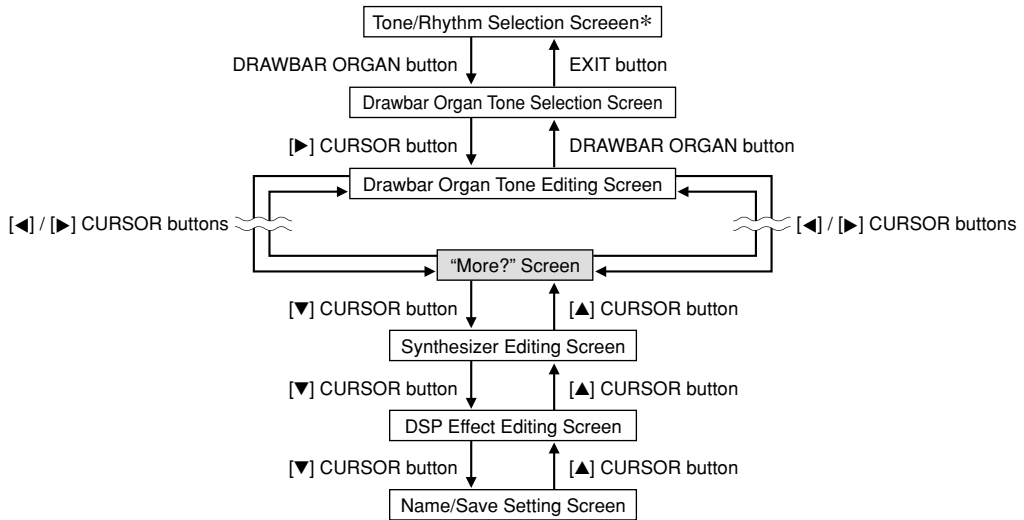

* You can also display the drawbar organ tone selection screen from the Song Memory Mode or SMF Playback Mode screen. In this case, however, the Drawbar Organ Tone Editing Screen does not appear.



Channel Buttons while the Drawbar Organ Tone Selection Screen is Displayed

The 18 buttons along the bottom of the display function as drawbar buttons while the drawbar organ tone selection screen is on the display (after you press the DRAWBAR ORGAN button). Each pair of buttons (upper and lower) represents a drawbar, which means that the 18 buttons provide you with the function of nine drawbars.

“ ’ ”: Feet

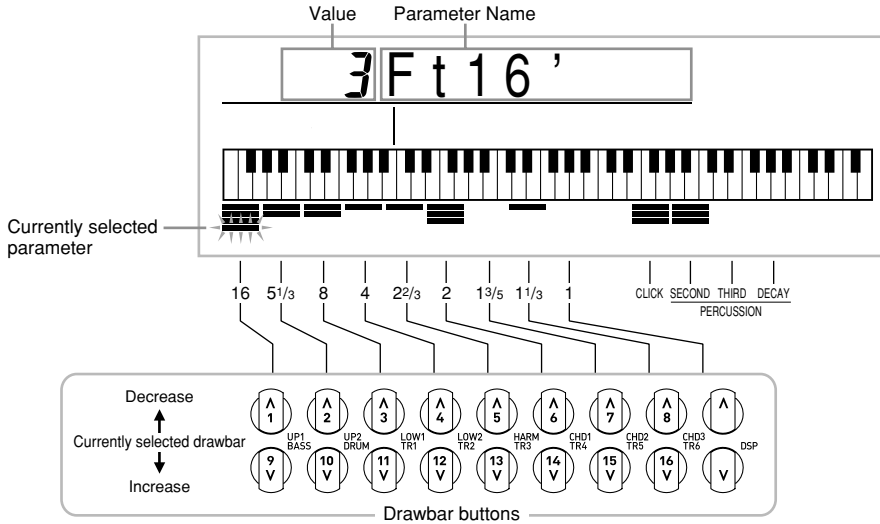

Each of the nine button pairs is assigned values ranging from 16 feet to 1 foot. Each button pair has a decrease button (for decreasing by 16 feet, 5-1/3 feet, etc.) and an increase button (for increasing by 16 feet, 5-1/3 feet, etc.).

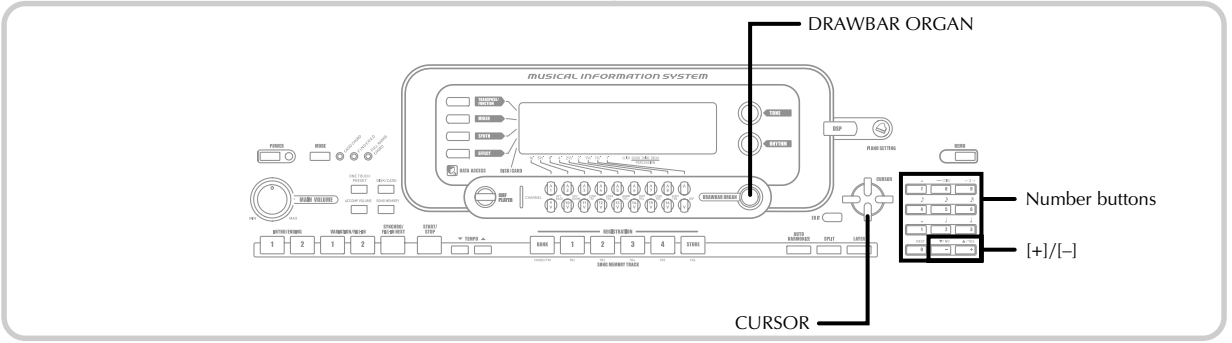

To select a drawbar organ tone

- 1 Find the drawbar organ tone you want to use in the tone list and note its tone number.
- 2 Press the DRAWBAR ORGAN button.
 - This causes the drawbar organ tone selection screen to appear.

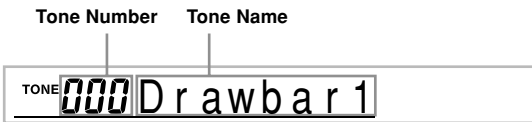

- 3 Use the number buttons to input the three digit tone number for the tone you want to select.

NOTE

- Always input all three digits for the tone number, including leading zeros (if any).
- You can also increment the displayed tone number by pressing [+] and decrement it by pressing [-].

To edit a drawbar organ tone

- 1 Select the drawbar organ tone (000 to 049, 100 to 199) you want to edit.

- 2 Use the [◀] and [▶] CURSOR buttons to display the drawbar organ tone editing screen. Select the parameter whose setting you want to change.

Example: Selecting the “Ft16” parameter

Parameter Setting Parameter Name

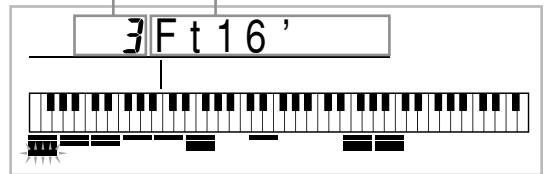

- There are a total of 13 parameters. You can use the [◀] and [▶] CURSOR buttons to cycle through them. See “Parameter Details” on page E-25 for more information.
 - While the “More?” screen is on the display, you can advance to the synthesizer and DSP effect editing screens by pressing the [▼] CURSOR button or the [+] button.
- 3 Use the [▲] and [▼] CURSOR buttons or the [+] and [-] buttons to change the setting of the currently displayed parameter.
 - You can also change a parameter setting by entering a value with the number buttons.
 - You can monitor the changes in a tone by playing notes on the keyboard as you adjust parameter settings.

NOTE

- Selecting a different tone after you edit parameters replaces parameter settings with those of the newly selected tone.
- If you have drawbar organ tones assigned to more than one channel, changing the drawbar organ setting for one of the channels causes the same setting to be applied to all of the other channels as well.
- See “To save an edited drawbar organ tone” on page E-26 for information about saving your edits.

Editing Synthesizer Mode Parameters and DSP Parameters of Drawbar Tones

As with standard (non-drawbar) tones, you can edit the Synthesizer Mode parameters and DSP parameters of drawbar organ tones. See “Drawbar Organ Mode Operational Flow” on page E-22.

- 1 Use the [◀] and [▶] CURSOR buttons to display “More?”, and then press the [▼] CURSOR button.
 - This enters the Synthesizer Mode, which is indicated by the indicator next to SYNTH on the display screen.
 - For the remainder of this procedure, perform the steps starting from step 3 under “Creating a User Tone” on page E-47.

Parameter Details

The following provides details about the parameters you can configure using the drawbar organ tone editing screen.

Drawbar Position

This parameter defines the position of each drawbar, and the volume of each overtone. The larger the value, the greater the corresponding overtone’s volume.

Parameter Name	Parameter Display Indication	Settings
Drawbar 16'	Ft 16'	0 to 3
Drawbar 5 1/3'	Ft 5 1/3'	0 to 3
Drawbar 8'	Ft 8'	0 to 3
Drawbar 4'	Ft 4'	0 to 3
Drawbar 2 2/3'	Ft 2 2/3'	0 to 3
Drawbar 2'	Ft 2'	0 to 3
Drawbar 1 3/5'	Ft 1 3/5'	0 to 3
Drawbar 1 1/3'	Ft 1 1/3'	0 to 3
Drawbar 1'	Ft 1'	0 to 3

(Ft: Feet)

Click

The parameter determines whether or not a key click is added when a sustained tone configured using the drawbars is played.

Parameter Name	Parameter Display Indication	Settings
Click	Click	oFF Click Off on Click On

Percussion

This parameter lets you add percussion sound, which provides modulation to sustained tones that you create. When you hold down a key on the keyboard, the sound produced decays until it is no longer audible. Pressing the key again sounds the note again at a louder volume. Percussion has “2nd Percussion” (2nd overtone pitch) and “3rd Percussion” (3rd overtone pitch) settings, each of which can be turned on or off.

You can also specify the percussion decay time, which controls how long it takes for the percussion sound to decay.

Parameter Name	Parameter Display Indication	Settings
2nd Percussion	Second	oFF Off on On
3rd Percussion	Third	
Percussion Decay Time	Decay	000 to 127





Display Contents in the Drawbar Organ Mode



In the Drawbar Organ Mode, the current status of the drawbar positions, key click, and percussion parameters are indicated on the display's bar graph as shown in the illustrations below. There is one line for each parameter, and the bottom segment of the selected parameter line flashes.

The bottom segment of the bar graph column that represents the currently selected parameter flashes to indicate that it is selected.



None of the channel numbers (1 to 16) are displayed in the drawbar organ tone mode and editing mode.

Drawbar Position Graph





Setting Value	0	1	2	3
Display				

 Off
 On
 Blink

Click and Percussion On/Off Graph

Setting Value	Off	On
Display		

Percussion Decay Time Graph

Setting Value	0-31	32-63	64-95	96-127
Display				

To save an edited drawbar organ tone

- 1 After editing parameters, use the [◀] and [▶] CURSOR buttons to display "More?".
- 2 Press the [▼] CURSOR button three times to display the screen for inputting a tone name and assigning a tone number.
 - You can select a tone number in the range of 100 to 199.
- 3 Use the [+] and [-] buttons or the number buttons to select a tone number.
 - Use the [+] and [-] buttons to scroll through letters at the current cursor location.
 - Use the [◀] and [▶] CURSOR buttons to move the cursor left and right.
 - See the page E-92 for information about inputting text.
- 4 After the tone name is the way you want, press the [▶] CURSOR button to store the tone.
 - This will display a confirmation message asking whether you really want to save the data. Press the YES button to save the data.
 - After the save operation is complete, the message "Complete" appears and then the display returns to the tone selection screen.
 - To cancel save, press the EXIT button.
- 5 After everything is the way you want, press the [▼] CURSOR button to store the tone.

Applying Effects to Tones

This keyboard provides you with a selection of effects that you can apply to tones. The built-in effects include a wide variety of variations that give you access to a selection of general digital effects.

Effect Blocks

The following shows how the effects of this keyboard are organized.

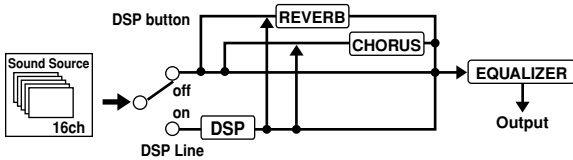

DSP

DSP effects are applied to the connection between the sound source and output. You can select distortion and modulation effects. You can create DSP effect setups and also transfer downloaded DSP data from your computer. The keyboard has memory that lets you store up to 100 DSP effect setups. See "Using the Music Data Management Software (on the Bundled CD-ROM)" on page E-80 and "Saving the Settings of DSP Parameters" on page E-29 for more information.

REVERB

Reverb simulates the acoustics of specific types of environments. You can choose from among 16 different reverb effects, including "Room" and "Hall".

CHORUS

The chorus effect gives sound greater depth by causing it to vibrate. You can choose from among 16 different chorus effects, including "Chorus" and "Flanger".

EQUALIZER

The equalizer is another type of effect that you can use to make adjustments in tone quality. Frequencies are divided among a number of bands, and raising and lowering the level of each frequency band alters the sound.

You can reproduce the optimal acoustics for the type of music you are playing (classics, for example) by selecting the applicable equalizer setting.

Channel Buttons while the Effect Mode Screen is Displayed

In the Effect Mode, the 18 buttons along the bottom of the display screen control the type and parameters of each effect, as shown in the illustration below.

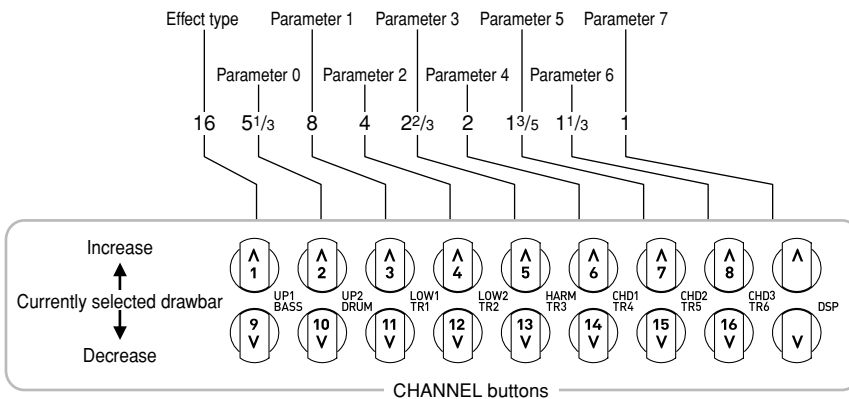

NOTE

- Pressing the [▲] and [▼] CURSOR buttons at the same time returns the currently selected effect to its preset value.

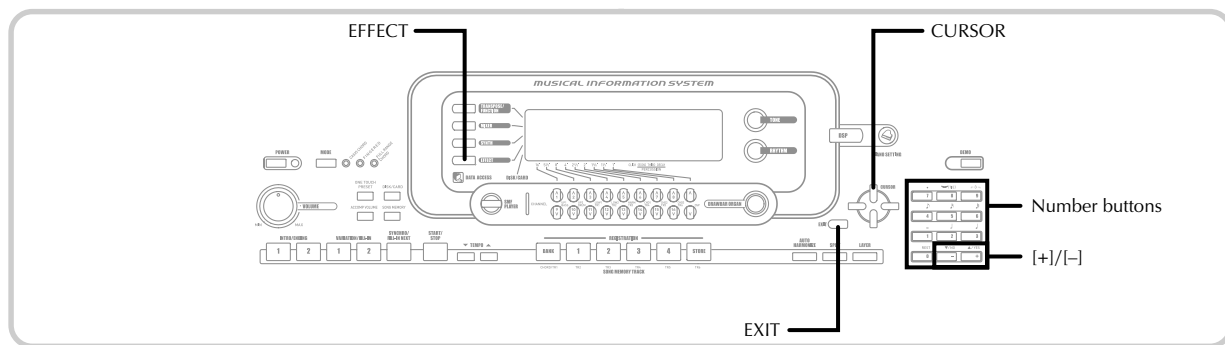

Selecting a DSP Type

In addition to the 100 built-in effect types, you can also edit effect types to create your own and store them in user memory. You can have up to 100 effect types in user memory at one time. You can also select the DSP type of the last DSP enabled tone that you used. This means you always have access to the DSP type of Advanced Tones and tones you download over the Internet. To select the DSP type of the last DSP enabled tone that you used, select “ton” in step 3 of the procedure below.

Perform the following steps to select a DSP type.

PREPARATION

- When using a DSP effect, you should use the Mixer to confirm that the DSP lines of the required parts are turned on. See “Mixer Function” on page E-40 for more information.

- 1 Press the EFFECT button so the pointer appears next to EFFECT on the display.
- 2 Press the [▶] CURSOR button.
 - The DSP type setting screen (step 3) will appear automatically about five seconds after you press the button.
- 3 Use the [+] and [-] buttons or number buttons to select the type of DSP you want.
 - See the “Effect List” on page A-14 for information about the DSP types that can be selected.
 - Here you could also change the parameters of the effect you selected, if you want. See “Changing the Settings of DSP Parameters” for more information.

NOTE

- The DSP type display area shows the DSP number (000 to 199), or “ton” (user tone created using DSP).

Changing the Settings of DSP Parameters

You can control the relative strength of a DSP and how it is applied. See the following section titled “DSP Parameters” for more information.

- 1 After selecting the DSP type you want, use the [◀] and [▶] CURSOR buttons to display the parameter whose setting you want to change.
 - This displays the parameter setting screen.
- 2 Use the [+] and [-] buttons or the number buttons to make the parameter setting you want.
 - Pressing the [+] and [-] buttons at the same time returns the parameter to its recommended setting.
- 3 Press the EFFECT or EXIT button.
 - This exits the tone or rhythm setting screen.

DSP Parameters

The following describes the parameters for each DSP.

DSP

■ Parameter 0 to 7

These parameters differ in accordance with the algorithm* of the selected DSP type. See the “Effect List” on page A-14 and the “DSP Algorithm List” on page A-16 for more information.

* Effector structure and operation type

■ DSP Reverb Send (Range: 000 to 127)

Specifies how much of the post-DSP sound should be sent to reverb.

■ DSP Chorus Send (Range: 000 to 127)

Specifies how much of the post-DSP sound should be sent to chorus.

NOTE

- Whether or not an effect is applied to the parts that are sounding also depends on Mixer Mode Reverb Send, Chorus Send, and DSP on/off settings. See “Mixer Function” on page E-40 for more information.
 - Playing a demo tune (page E-12) automatically changes the effect to the one that is assigned to the tune. You cannot change or cancel a demo tune effect.
 - Changing the effect setting while sound is being output by the keyboard causes a slight break in the sound when the effect changes.
 - A number of tones, called “Advanced Tones”, automatically turn on the DSP line for richer, higher quality sound. If you assign an Advanced Tone to a keyboard part (Channels 1 through 4), the DSP line turns on automatically and the DSP selection changes in accordance with the settings of the Advanced Tone. Also, the Mixer Mode DSP line on/off setting for the keyboard part to which the Advanced Tone is assigned is turned on.*
- * The Mixer DSP line setting is automatically turned off for each part that does not have an Advanced Tone assigned. Because of this, DSP effects previously applied to these parts are cancelled, which can make their tone sound different. In this case, display the Mixer screen and turn DSP back on.

Saving the Settings of DSP Parameters

You can save up to 100 modified DSPs in the user area for later recall when you need them.

NOTE

- User DSP areas 100 through 199 initially contain the same data as DSP types 000 through 099.

- 1 After making the DSP parameter settings you want, press the [▼] CURSOR button.
 - This causes the DSP number of the user area where the DSP will be saved to flash on the display.
- 2 Use the [+] and [-] buttons or the number buttons to select the user DSP area number where you want to save the new DSP.
 - You can select a user DSP area number in the range of 100 to 199 only.
- 3 After the user DSP area number you want is selected, press the [▶] CURSOR button.
 - Use the [+] and [-] buttons to scroll through letters at the current cursor location.
 - Use the [◀] and [▶] CURSOR buttons to move the cursor left and right.
 - See the page E-92 for information about inputting text.

- 4 After everything is the way you want, press the [▼] CURSOR button to store the effect.
 - This will display a confirmation message asking whether you really want to save the data. Press the YES button to save the data.
 - The message “Complete” appears momentarily on the display, followed by the tone or rhythm selection screen.

About the DSP Button

Checking the DSP button will tell you whether or not DSP is enabled for the tone that is currently selected for a part. The DSP button will be lit for a tone that is DSP enabled (DSP line ON), and unlit for a tone that is DSP disabled (DSP line OFF). For example, when you move each part while using the split/layer function, the DSP button lights or goes out in accordance with that parts setting.

Pressing the DSP button toggles the tone of the part you are currently playing on the keyboard between enabled (DSP line ON) and disabled (DSP line OFF).

To turn DSP line on and off

- 1 Press the DSP button to toggle DSP line for the currently selected part on and off.

Selecting REVERB

Perform the following steps to select REVERB.

- 1 Press the EFFECT button, so the pointer appears next to EFFECT on the display screen.

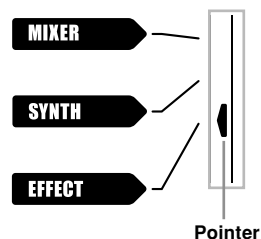

- 2 Press the [▼] CURSOR button once.
 - This displays the reverb editing screen.
 - The reverb type setting screen (step 4) will appear automatically about five seconds after you press the button.
- 3 Press the [▶] CURSOR button.

4 Use the [+] and [-] buttons or the number buttons to scroll through the reverb types until the one you want is displayed, or use the number buttons to input the reverb number you want to select.

- See the list on page A-14 for information about the types of REVERB effects that are available.
- Here you could also change the parameters of the effect you selected, if you want. See “Changing the Settings of REVERB Parameters” for more information.

Changing the Settings of REVERB Parameters

You can control the relative strength of a reverb and how it is applied. See the following section titled “REVERB Parameters” for more information.

1 After selecting the reverb type you want, use the [◀] and [▶] CURSOR buttons to display the parameter whose setting you want to change.

- This displays the parameter setting screen.

Example: To set the Reverb Time parameter



072 SRv Time

2 Use the [+] and [-] buttons or the number buttons to input the parameter setting you want.

3 Press the EFFECT or EXIT button.

- This returns to the tone or rhythm selection screen.

REVERB Parameters

Reverb effects are associated with either a reverb type or delay type. Parameter settings depend upon the associated type.

Reverb Type (No. 0 to 5, 8 to 13)

■ Reverb Level (Range: 000 to 127)

Controls the reverb size. A larger number produces larger reverb.

■ Reverb Time (Range: 000 to 127)

Controls how long reverb continues. A larger number produces longer reverb.

■ ER Level (Initial Echo Sound) (Range: 000 to 127)

This parameter controls the initial reverb volume. The initial echo sound is the first sound reflected from the walls and ceiling when a sound is output by this keyboard. A larger value specifies a larger echo sound.

■ High Damp (Range: 000 to 127)

Adjusts the damping of high frequency reverberation (high sound). A smaller value damps high sounds, creating a dark reverb. A larger value does not damp high sounds, for a brighter reverb.

Delay Type (No. 6, 7, 14, 15)

■ Delay Level (Range: 000 to 127)

Specifies the size of the delay sound. A higher value produces a larger delay sound.

■ Delay Feedback (Range: 000 to 127)

Adjusts delay repeat. A higher value produces a greater number of repeats.

■ ER Level

Same as Reverb Type

■ High Damp

Same as Reverb Type

NOTE

- Whether or not an effect is applied to the parts that are sounding also depends on Mixer Mode Reverb Send, Chorus Send, and DSP on/off settings. See “Mixer Function” on page E-40 for more information.

Selecting CHORUS

Perform the following steps to select CHORUS.

1 Press the EFFECT button, so the pointer appears next to EFFECT on the display screen.

2 Press the [▼] CURSOR button twice.

- This displays the chorus editing screen.
- The chorus type setting screen (step 4) will appear automatically about five seconds after you press the button.

3 Press the [▶] CURSOR button.

4 Use the [+] and [-] buttons or the number buttons to scroll through the chorus types until the one you want is displayed, or use the number buttons to input the chorus number you want to select.

- See the list on page A-14 for information about the types of CHORUS effects that are available.
- Here you could also change the parameters of the effect you selected, if you want. See “Changing the Settings of CHORUS Parameters” for more information.

Changing the Settings of CHORUS Parameters

You can control the relative strength of an effect and how it is applied. The parameters you can control depend on the effect. See the following section titled “CHORUS Parameters” for more information.

- 1 After selecting the chorus type you want, use the [◀] and [▶] CURSOR buttons to display the parameter whose setting you want to change.
 - This displays the parameter setting screen.
- 2 Use the [+] and [-] buttons or the number buttons to input the parameter setting you want.
- 3 Press the EFFECT or EXIT button.
 - This returns to the tone or rhythm selection screen.

CHORUS Parameters

■ Chorus Level (Range: 000 to 127)

Specifies the size of the chorus sound.

■ Chorus Rate (Range: 000 to 127)

Specifies the undulation speed of the chorus sound. A higher value produces faster undulation.

■ Chorus Depth (Range: 000 to 127)

Specifies the undulation depth of the chorus sound. A higher value produces deeper undulation.

NOTE

- Whether or not an effect is applied to the parts that are sounding also depends on Mixer Mode Reverb Send, Chorus Send, and DSP on/off settings. See “Mixer Function” on page E-40 for more information.

Using the Equalizer

This keyboard has a built-in four-band equalizer and 10 different settings from which you can choose. You can adjust the gain (volume) of all four equalizer bands within the range of -12 to 0 to +12.

To select the equalizer type

- 1 Press the EFFECT button, so the pointer appears next to EFFECT on the display screen.
- 2 Press the [▼] CURSOR button three times.
 - This displays the equalizer editing screen.
 - The equalizer type setting screen (step 4) will appear automatically about five seconds after you press the button.

- 3 Press the [▶] CURSOR button.
 - 4 Use the [+] and [-] buttons or the number buttons to select the equalizer type you want.
 - See the list on page A-14 for information about the equalizer types that are available.
- Example:* To select Jazz



Jazz

- Pressing the EXIT or EFFECT button exits the equalizer setting screen.

To adjust the gain (volume) of a band

- 1 After selecting the equalizer type you want, use the [◀] and [▶] CURSOR buttons to select the band whose gain you want to adjust.

Example: To adjust the HIGH band

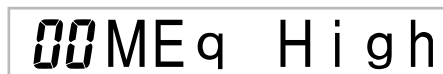

00MEq High

- 2 Use the [+] and [-] buttons or the number buttons to adjust the band gain.

Example: To adjust the gain to 10

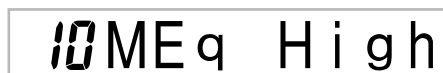

10MEq High

- Pressing the EXIT or EFFECT button exits the equalizer setting screen.

NOTE

- Changing to another equalizer type causes the band gain settings to change to the initial settings for the newly selected equalizer type automatically.

Auto Accompaniment

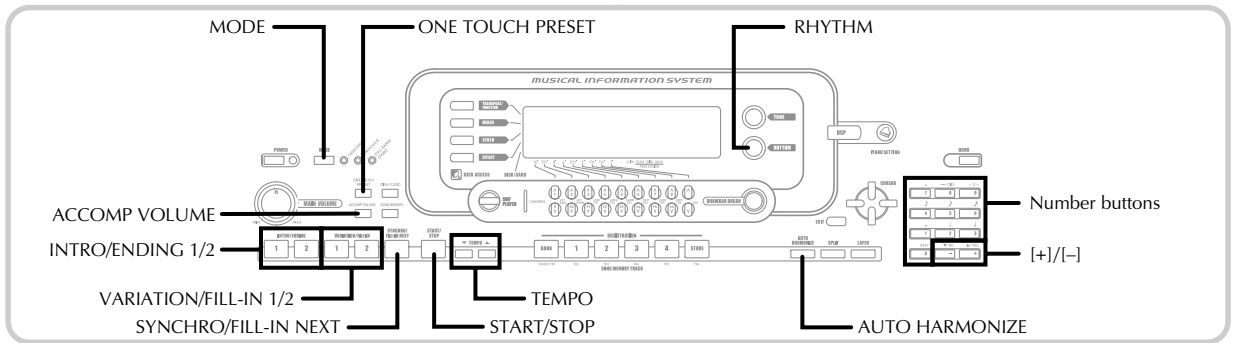

This keyboard automatically plays bass and chord parts in accordance with the chords you finger. The bass and chord parts are played using sounds and tones that are automatically selected to select the rhythm you are using. All of this means that you get full, realistic accompaniments for the melody notes you play with your right hand, creating the mood of a one-person ensemble.

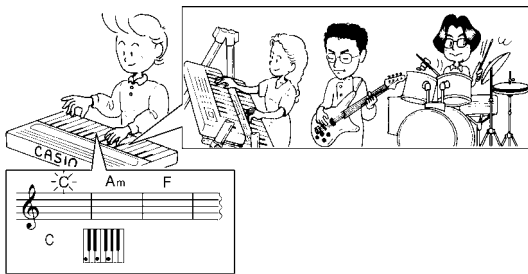

About the MODE Button

Use the MODE button to select the accompaniment mode you want to use. Each press of the MODE button cycles through the available accompaniment modes as shown in the illustration below.

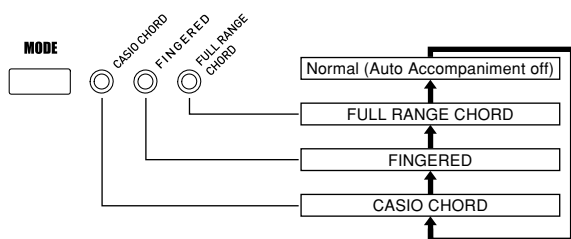

- Only rhythm sounds are produced when all accompaniment mode lamps are off.
- The currently selected accompaniment mode is shown by the mode lamps above the MODE button. Information on using each of these modes starts from page E-34.

Selecting a Rhythm

This keyboard provides you with 160 exciting rhythms that you can select using the following procedure. You can also transfer accompaniment data from your computer and store up to 16 of them as user rhythms in keyboard memory. See "Using the Music Data Management Software (on the Bundled CD-ROM)" on page E-80 for more information.

To select a rhythm

- 1 Find the rhythm you want to use in the rhythm list and note its rhythm number.
- 2 Press the RHYTHM button.
 - Not all of the available rhythms are shown on the rhythm list printed on the keyboard console. For a complete list, see the "Rhythm List" on page A-11.

Number and name of selected rhythm



Appears when RHYTHM button is pressed

- 3 Use the number buttons to input the three digit rhythm number for the rhythm you want to select. *Example: To select "052 ROCK 2", input 0, 5 and then 2.*

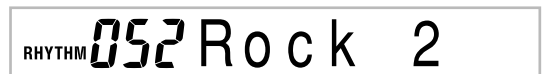

NOTE

- You can also increment the displayed rhythm number by pressing [+] and decrement it by pressing [-].

Playing a Rhythm

To play a rhythm

- 1 Press VARIATION/FILL-IN button 1 or 2.
 - This starts the play of the selected rhythm.
 - To stop rhythm play, press the START/STOP button.

NOTE

- Chords will sound along with the rhythm if any of the three accompaniment mode lamps above the MODE button is lit. If you want to play the rhythm pattern without chords, press the MODE button until all of the lamps are off.

Adjusting the Tempo

You can adjust the tempo of rhythm play within a range of 30 to 255 beats per minute. The tempo setting is used for Auto Accompaniment chord play, and song memory operations.

To adjust the tempo

- 1 Press one of the TEMPO buttons (▲ or ▼).
 - ▲ : Increments displayed value (increases tempo)
 - ▼ : Decrements displayed value (decreases tempo)



NOTE

- Pressing both TEMPO buttons (▲ and ▼) at the same time resets the tempo to the default value of the currently selected rhythm.

Using Auto Accompaniment

The following procedure describes how to use the keyboard's Auto Accompaniment feature. Before starting, you should first select the rhythm you want to use and set the tempo of the rhythm to the value you want.

To use Auto Accompaniment

- 1 Use the MODE button to select CASIO CHORD, FINGERED, or FULL RANGE CHORD as the accompaniment mode.
 - The currently selected accompaniment mode is the one whose lamp is lit. See "About the MODE Button" on page E-32 for details.
- 2 Press the START/STOP button to start play of the currently selected rhythm.
- 3 Play a chord.
 - The actual procedure you should use to play a chord depends on the currently selected accompaniment mode. Refer to the following pages for details on chord play.

CASIO CHORD Page E-34

FINGERED Page E-35

FULL RANGE CHORD Page E-35

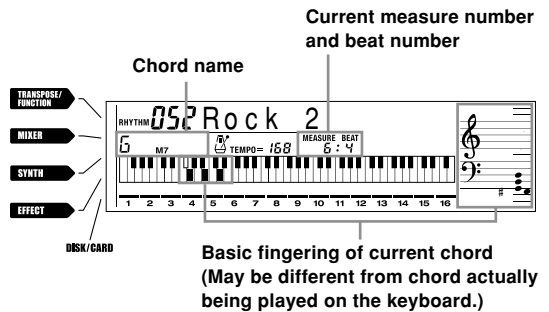

- 4 To stop Auto Accompaniment play, press the START/STOP button again.

NOTE

- If you press the SYNCHRO/FILL-IN NEXT button and then the VARIATION/FILL-IN 1/2 buttons in place of the START/STOP button in step 2, accompaniment will start with an intro pattern when you perform the operation in step 3. For details about these buttons, see pages E-36 and E-37.
- If you press the VARIATION/FILL-IN 1/2 buttons in place of the START/STOP button in step 4, an ending pattern will play before accompaniment play is ended. For details about this button, see page E-37.
- You can adjust the accompaniment part volume level independently of the main volume. For details, see "Adjusting the Accompaniment Volume" on page E-39.

CASIO CHORD

This method of chord play makes it possible for anyone to easily play chords, regardless of previous musical knowledge and experience. The following describes the CASIO CHORD "accompaniment keyboard" and "melody keyboard", and tells you how to play CASIO CHORDs.

CASIO CHORD Accompaniment Keyboard and Melody Keyboard

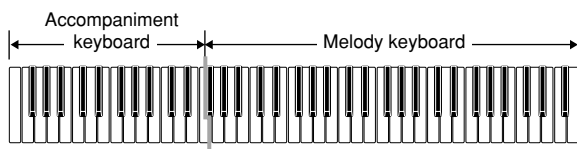

NOTE

- The accompaniment keyboard can be used for playing chords only. No sound will be produced if you try playing single melody notes on the accompaniment keyboard.

Chord Types

CASIO CHORD accompaniment lets you play four types of chords with minimal fingering.

Chord Types	Example
<p>Major chords</p> <p>Major chord names are marked above the keys of the accompaniment keyboard. Note that the chord produced when you press an accompaniment keyboard does not change octave, regardless of which key you use to play it.</p>	<p>C Major (C)</p>
<p>Minor chords (m)</p> <p>To play a minor chord, keep the major chord key depressed and press any other accompaniment keyboard key located to the right of the major chord key.</p>	<p>C minor (Cm)</p>
<p>Seventh chords (7)</p> <p>To play a seventh chord, keep the major chord key depressed and press any other two accompaniment keyboard keys located to the right of the major chord key.</p>	<p>C seventh (C7)</p>
<p>Minor seventh chords (m7)</p> <p>To play a minor seventh chord, keep the major chord key depressed and press any other three accompaniment keyboard keys located to the right of the major chord key.</p>	<p>C minor seventh (Cm7)</p>

NOTE

- It makes no difference whether you press black or white keys to the right of a major chord key when playing minor and seventh chords.

FINGERED

FINGERED provides you with a total of 15 different chord types. The following describes the FINGERED “accompaniment keyboard” and “melody keyboard”, and tells you how to play a C-root chord using FINGERED.

FINGERED Accompaniment Keyboard and Melody Keyboard

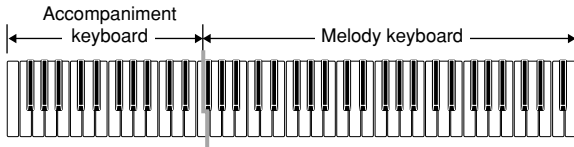

NOTE

- The accompaniment keyboard can be used for playing chords only. No sound will be produced if you try playing single melody notes on the accompaniment keyboard.

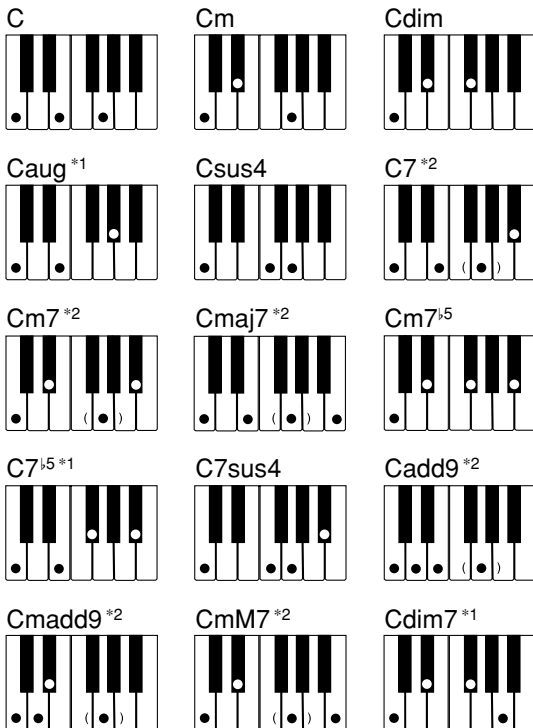

See the “Fingered Chord Chart” on page A-12 for details on playing chords with other roots.

*1: Inverted fingerings cannot be used. The lowest note is the root.

*2: The same chord can be played without pressing the 5th G.

NOTE

- Except for the chords specified in note*1 above, inverted fingerings (i.e. playing E-G-C or G-C-E instead of C-E-G) will produce the same chords as the standard fingering.
- Except for the exception specified in note*2 above, all of the keys that make up a chord must be pressed. Failure to press even a single key will not play the desired FINGERED chord.

FULL RANGE CHORD

This accompaniment method provides a total of 38 different chord types: the 15 chord types available with FINGERED plus 23 additional types. The keyboard interprets any input of three or more keys that matches a FULL RANGE CHORD pattern to be a chord. Any other input (that is not a FULL RANGE CHORD pattern) is interpreted as melody play. Because of this, there is no need for a separate accompaniment keyboard, so the entire keyboard, from end to end, functions as a melody keyboard that can be used for both melody and chords.

FULL RANGE CHORD Accompaniment Keyboard and Melody Keyboard

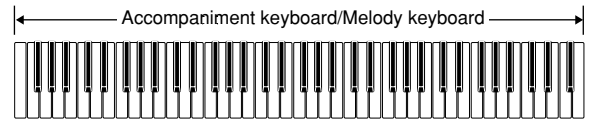

Chords Recognized by This Keyboard

The following table identifies patterns that are recognized as chords by FULL RANGE CHORD.

Pattern Type	Number of Variations
FINGERED	The 15 chord patterns shown under FINGERED on page E-35. See the "Fingered Chord Chart" on page A-12 for details on playing chords with other roots.
Standard Fingerings	<p>23 standard chord fingerings. The following are examples of the 23 chords available with C as the bass note.</p> <p>C₆ • Cm₆ • C₆₉</p> <p>$\frac{C^\sharp}{C}$ • $\frac{D}{C}$ • $\frac{E}{C}$ • $\frac{F}{C}$ • $\frac{G}{C}$ • $\frac{A^\flat}{C}$ • $\frac{B^\flat}{C}$</p> <p>$\frac{B}{C}$ • $\frac{C^\sharp m}{C}$ • $\frac{Dm}{C}$ • $\frac{Fm}{C}$ • $\frac{Gm}{C}$ • $\frac{Am}{C}$ • $\frac{B^\flat m}{C}$</p> <p>$\frac{Dm7^\flat5}{C}$ • $\frac{A^\flat7}{C}$ • $\frac{F7}{C}$ • $\frac{Fm7}{C}$ • $\frac{Gm7}{C}$ • $\frac{A^{add9}}{C}$</p>

Example: To play the chord C major.

Any of the fingerings shown in the illustration below will produce C major.

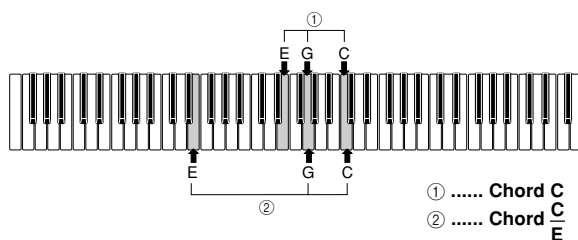

NOTE

- As with the FINGERED mode (page E-35), you can play the notes that form a chord in any combination (①).
- When the lowest note of a chord is separated from its neighboring note by six or more semitones, the lowest note becomes the bass note (②).

Using an Intro Pattern

This keyboard lets you insert a short intro into a rhythm pattern to make startup smoother and more natural.

The following procedure describes how to use the Intro feature. Before starting, you should first select the rhythm you want to use, set the tempo, and use the MODE button to select the chord play method you want to use (Normal, CASIO CHORD, FINGERED, FULL RANGE CHORD).

To insert an intro

- 1 Press INTRO/ENDING button 1 or 2.
 - With the above setup, the intro pattern is played and the auto accompaniment with intro pattern starts as soon as you play chords on the accompaniment keyboard.

NOTE

- The standard rhythm pattern starts to play after the intro pattern is complete.

Using a Fill-in Pattern

Fill-in patterns let you momentarily change the rhythm pattern to add some interesting variation to your performances.

The following procedure describes how to use the Fill-in feature.

To insert a fill-in

- 1 Press the START/STOP button to start rhythm play.
- 2 Select the fill-in variation you want.
 - To insert Fill-in 1, press the VARIATION/FILL-IN 1 button while Variation 1 of the rhythm is playing.
 - To insert Fill-in 2, press the VARIATION/FILL-IN 2 button while Variation 2 of the rhythm is playing.

NOTE

- Only the SYNCHRO/FILL-IN NEXT button is operational while an intro is playing.
- Holding down the SYNCHRO/FILL-IN NEXT or VARIATION/FILL-IN 1/2 buttons causes the fill-in pattern to repeat.

Using a Rhythm Variation

In addition to the standard rhythm pattern, you can also switch to a secondary “variation” rhythm pattern for a bit of variety .

To insert the variation rhythm pattern

- 1 Press the START/STOP button to start rhythm play.
- 2 Press the SYNCHRO/FILL-IN NEXT button.
 - If a Variation 1 rhythm is currently playing, this plays Fill-in 1, followed by Fill-in 2, and then switches to the Variation 2 rhythm.
 - If a Variation 2 rhythm is currently playing, this plays Fill-in 2, followed by Fill-in 1, and then switches to the Variation 1 rhythm.
 - Holding down the SYNCHRO/FILL-IN NEXT button causes the fill-in pattern to repeat.

Synchro Starting Accompaniment with Rhythm Play

You can set up the keyboard to start rhythm play at the same time you play the accompaniment on the keyboard.

The following procedure describes how to use synchro start. Before starting, you should first select the rhythm you want to use, set the tempo, and use the MODE button to select the chord play method you want to use (Normal, CASIO CHORD, FINGERED, FULL RANGE CHORD).

To use synchro start

- 1 Press the SYNCHRO/FILL-IN NEXT button to put the keyboard into synchro start standby.



- 2 Play a chord and the rhythm pattern starts to play automatically.

NOTE

- If the MODE button is set to Normal, only the rhythm plays (without a chord) when you play on the accompaniment keyboard.
- If you press the INTRO/ENDING button 1 or 2 before playing anything on the keyboard, the rhythm starts automatically with an intro pattern when you play something on the accompaniment keyboard.
- To cancel synchro start standby, press the SYNCHRO/FILL-IN NEXT button one more time.

Finishing with an Ending Pattern

You can end your performances with an ending pattern that brings the rhythm pattern you are using to a natural-sounding conclusion.

The following procedure describes how to insert an ending pattern. Note that the actual ending pattern played depends on the rhythm pattern you are using.

To finish with an ending pattern

- 1 While the rhythm is playing, press INTRO/ENDING button 1 or 2.
 - The timing when the ending pattern starts depends on when you press the INTRO/ENDING button 1 or 2. If you press the button before the second beat of the current measure, the ending pattern starts playing immediately.

NOTE

- Pressing the INTRO/ENDING button prior to the first half beat at the beginning of a measure plays the ending immediately. Pressing the button after the first half beat of a measure causes the ending to be played from the beginning of the following measure.

Using One-touch Preset

One-touch preset automatically makes the main settings listed below in accordance with the rhythm pattern you are using.

- Keyboard tone
- Layer on/off
- Split on/off
- Auto Harmonize on/off
- Auto Harmonize type
- Accompaniment volume level
- Tempo
- Effect settings

To use one-touch preset

- Select the rhythm you want to use.
- Use the MODE button to select the accompaniment mode you want to use.
- Press the ONE TOUCH PRESET button.
 - This automatically makes the one-touch preset settings in accordance with the rhythm you selected.
 - The keyboard automatically enters synchro standby at this time.
- Start rhythm and Auto Accompaniment, and play something on the keyboard.
 - Accompaniment is played using the one-touch preset settings.

Using Auto Harmonize

When you are using Auto Accompaniment, Auto Harmonize automatically adds additional notes to your melody in accordance with the chord that is being played. The result is a harmony effect that makes your melody line richer and fuller.

To use Auto Harmonize

- Use the MODE button to select FINGERED or CASIO CHORD as the accompaniment mode.
 - The currently selected accompaniment mode is the one whose lamp is lit. See "About the MODE Button" on page E-32 for details.

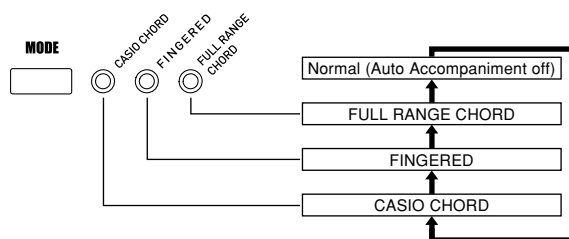

- Press AUTO HARMONIZE button to turn on Auto Harmonize.
 - This causes the AUTO HARMONIZE indicator to appear on the display.



- Start Auto Accompaniment play, and play something on the keyboard.
- To turn off Auto Harmonize, press AUTO HARMONIZE button once.
 - This causes the AUTO HARMONIZE indicator to disappear.

NOTE

- Auto Harmonize turns off temporarily whenever you start demo tune play. It turns back on as soon as the operation or function that caused it to turn off is finished.
- Auto Harmonize is enabled only when the Auto Accompaniment mode is FINGERED or CASIO CHORD.

Auto Harmonize Types

Auto Harmonize lets you select from among the 10 Auto Harmonize types. Type changing is performed by the setting item using the TRANSPOSE/FUNCTION button.

See “Changing Other Settings” on page E-70 for more information.

About Auto Harmonize notes and tones

The notes you play on the keyboard are called “melody notes”, while the notes added to the melody by Auto Harmonize is called the “harmonize notes”. Auto Harmonize normally uses the tone you selected for the melody notes as the tone for the harmonize notes, but you can use the Mixer (page E-40) to specify a different tone for the harmonize notes. The harmonize note tone is assigned to Mixer Channel 5, so change Channel 5 to the tone you want to use for the harmonize notes.

In addition to the tone, you can also use the Mixer to change a number of other parameters, such as volume balance. See “Using the Parameter Edit Mode” on page E-41 for details on these procedures.

NOTE

- The default harmonize note tone when you first turn on Auto Harmonize is the same tone as the melody note tone.
- Changing the melody tone setting automatically changes the harmonize note tone to the same setting.

Adjusting the Accompaniment Volume

You can adjust the volume of the accompaniment parts as a value in the range of 000 (minimum) to 127 (maximum).

- 1 Press the ACCOMP VOLUME button.

Current accompaniment volume setting

100 Ac omp Vol

- 2 Use the number buttons or the [+]/[-] buttons to change the current volume setting value.

Example: 110

110 Ac omp Vol

NOTE

- Pressing the ACCOMP VOLUME button or EXIT button returns to the tone or rhythm setting screen.
- Any channel balance settings you make with the Mixer are maintained when you change the accompaniment volume setting.
- Pressing [+] and [-] buttons at the same time automatically sets an accompaniment volume of 100.

Mixer Function

What you can do with the Mixer

This keyboard lets you play multiple different musical instrument parts at the same time during auto-accompaniment play, song memory playback, receipt of data through the MIDI terminal, etc. The Mixer assigns each part to a separate channel (1 through 16) and lets you control the channel on/off, volume, and pan pot parameters of each channel.

In addition to channels 1 through 16, the Mixer also has a DSP channel that you can use to adjust the DSP level, DSP pan, and other DSP parameters.

Channel Assignments

The following shows the parts that are assigned to each of the 16 channels.

Channel Number	Part
Channel 1	Main tone (UP1)
Channel 2	Layered tone (UP2)
Channel 3	Split tone (LOW1)
Channel 4	Layered/split tone (LOW2)
Channel 5	Harmonize Tone (HARM)
Channel 6	Auto Accompaniment chord part 1 (CHD1)
Channel 7	Auto Accompaniment chord part 2 (CHD2)
Channel 8	Auto Accompaniment chord part 3 (CHD3)
Channel 9	Auto Accompaniment bass part (BASS)
Channel 10	Auto Accompaniment rhythm part (DRUM)
Channel 11	Song Memory track 1 (TR1)
Channel 12	Song Memory track 2 (TR2)
Channel 13	Song Memory track 3 (TR3)
Channel 14	Song Memory track 4 (TR4)
Channel 15	Song Memory track 5 (TR5)
Channel 16	Song Memory track 6 (TR6)

NOTE

- In this manual, "Channel Number" matches the channel numbers marked on the keyboard above the CHANNEL buttons.
- The CHANNEL button name in the above table corresponds to the text marked on the keyboard below the CHANNEL buttons.

See pages E-65 to E-67 for information on layered, split, and layered/split tones.

See page E-53 for information on the song memory.

NOTE

- Normally, keyboard play is assigned to Channel 1. When Auto Accompaniment is being used, each part of the accompaniment is assigned to Channels 6 through 10.
- When this keyboard is being used as the sound source for an externally connected computer or other MIDI device, all 16 channels are assigned musical instrument parts. The notes played over the channel selected by operation under "Turning Channels On and Off" below are shown on the displayed keyboard and staff.

Turning Channels On and Off

Press the CHANNEL buttons to toggle individual channels on and off. Indicators on the display show the current on/off status of each channel.



Channel on

Channel off

- Each press of a CHANNEL button toggles the applicable channel on and off.
- The on/off status of each channel determines the on/off status of the corresponding part for keyboard play, Auto Accompaniment, and Song Memory playback.
- Changing to a different rhythm causes Mixer Settings for channel 6 through channel 10 to change to the default settings assigned to the new rhythm. These settings also change to the defaults for the currently selected rhythm pattern whenever you switch between the Intro, Normal, Variation, Fill-in, and Ending patterns.

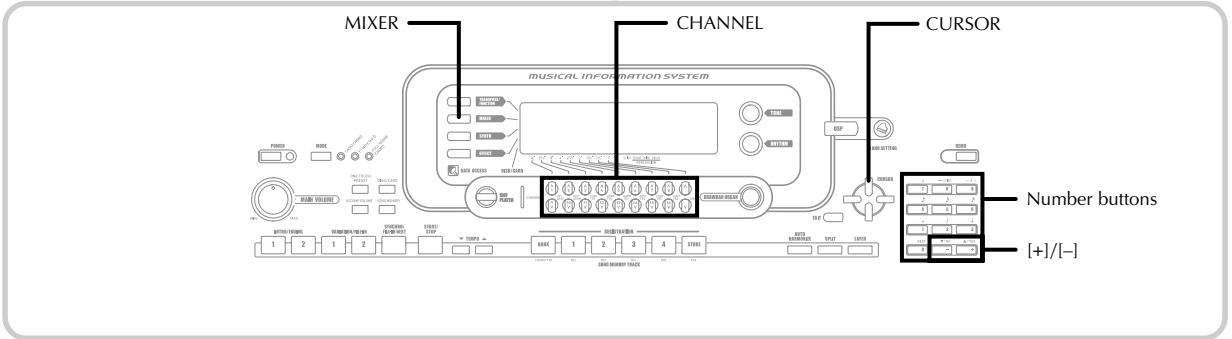

Using the Parameter Edit Mode

Editing the Parameters for Channels 1 through 16

In the Parameter Edit Mode, you can change the settings of ten different parameters (including tone, volume, and pan pot) for the channel you selected on the Mixer screen.

To change parameters

- 1 Press the MIXER button.
 - This causes a pointer to appear on the display next to MIXER.
- 2 Press a CHANNEL button (1 through 16) to select a channel.
 - Use the [◀] and [▶] CURSOR buttons to change between channels.
- 3 Use [▲] and [▼] CURSOR buttons to select the parameter whose setting you want to change.

Example: Select volume setting by displaying “Volume”.

 - Each press of [▲] or [▼] CURSOR button cycles through the parameters.
 - You can use the [◀] and [▶] CURSOR buttons to change to another channel at any time during this procedure.

Indicates channel volume of 127

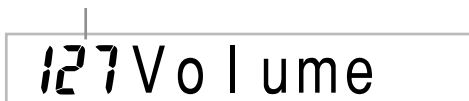

- 4 Use the number buttons or [+] and [-] to change the parameter setting.

Example: Change the setting to “060”.



- Pressing the MIXER or EXIT button exits the parameter edit mode.

Editing DSP Channel Parameters

- 1 Press the CHANNEL (DSP) button.
 - You can also select the DSP channel by pressing the [▶] CURSOR button while Channel 16 is selected.
 - This selects the DSP channel.
 - Pressing the [◀] CURSOR button while the DSP channel is selected returns to Channel 16.

How Parameters Work

The following are the parameters whose settings can be changed in the Parameter Edit Mode.

Tone Parameters

■ Tone

(Range: 000 to 903, Drawbar organ tones 000 to 199)

This parameter controls the tones assigned to each part. Anytime the tone is on the display, you can use the TONE button or DRAWBAR ORGAN button and then select a different tone, if you want.

000 St . Gr P no

■ Part On/Off (Settings: on, oFF)

This parameter can be used to turn each part on (sounds) and off (does not sound). The current on/off status of each part is indicated on the display as described below.

on Channel

■ Volume (Range: 000 to 127)

This is the parameter that controls the volume of the selected channel.

127 Volume

■ Pan Pot (Range: -64 to 00 to +63)

This parameter controls the pan pot, which is the center point of the left and right stereo channels. Setting "00" specifies center, a value less than "00" moves the point left, and a value greater than "00" moves it right.

63 Pan

■ Octave Shift (Range: -2 to 0 to +2)

You can use octave shift to shift the range of the tone up or down. When using the piccolo tone, there may be cases when very high notes you want to play are not included within the range of the keyboard. When this happens, you can use octave shift to shift the keyboard range one octave up.

0 Oct Shift

-2 : Range shifted two octaves down.

-1 : Range shifted one octave down.

0 : No shift

+1 : Range shifted one octave up.

+2 : Range shifted two octaves up.

Tuning Parameters

You can use these parameters to tune each of the parts individually.

■ Coarse Tune (Range: -24 to 00 to +24)

This parameter controls the coarse tuning of the selected channel's pitch in semitone units.

00 C . Tune

■ Fine Tune (Range: -99 to 00 to +99)

This parameter controls the fine tuning of the selected channel's pitch in cent units.

00 Fine Tune

Effect Parameters

The Mixer lets you control the effects applied to each individual part, making it different from the Effect Mode, whose settings are applied to all parts in general.

■ Reverb Send (Range: 000 to 127)

This parameter controls how much reverb is applied to a part. A setting of "000" turns reverb off, while a setting of 127 applies maximum reverb.

- "Reverb Send" does not work with some drum sounds.

056 Rvb Send

■ Chorus Send (Range: 000 to 127)

This parameter controls how much chorus send is applied to a part. A setting "000" turns chorus send off, while a setting of 127 applies maximum chorus send.

- "Chorus Send" does not work with drum sounds.

000 Cho Send

■ DSP Line (Settings: on, oFF)

You can use this parameter to turn DSP line off for a particular channel, or to turn it on.

oFF DSP Line

DSP Part Parameters

■ DSP Level (Range: 0 to 127)

Sets the post-DSP volume.

127 DSP Level

■ DSP Pan (Range: -64 to 0 to 63)

Sets the post-DSP stereo pan.

000 DSP Pan

■ DSP System Reverb Send (Range: 000 to 127)

This parameter adjusts how much reverb is applied to all parts.

000 D . Rvb Snd

■ DSP System Chorus Send (Range: 000 to 127)

This parameter adjusts chorus.

000 D . Cho Snd

NOTE

- Changing the tone, volume, pan pot, coarse tune, fine tune, reverb send, or chorus send setting causes the corresponding MIDI message to be output from the MIDI terminal.
- Changing the tone settings changes the tone, octave shift, reverb send, chorus send, and DSP line* parameter settings.
 - * When DSP is off (See the note on page E-73).
- Turning on the Mixer's DSP Line parameter (on this page) causes the settings of the DSP Pan, DSP System Reverb Send, and DSP System Chorus parameters to be used in place of the Pan Pot, Reverb Send, and Chorus Send parameters.

Synthesizer Mode

The Synthesizer Mode of this keyboard provides the tools for creating your own original tones. Simply select one of the built-in tones and change its parameters to create your own original sound. You can even store your sounds in memory and select it using the same procedure as that used to select a preset tone.

Synthesizer Mode Functions

The following describes how to use each of the functions available in the Synthesizer Mode.

Synthesizer Mode Parameters

The preset tones that are built into this keyboard consist of a number of parameters. To create a user tone, you first recall an advanced tone (000 to 331) or a preset tone (400 to 599) and then change its parameters to change it to your own tone. Note that drum set tones (600 through 617) cannot be used as the basis of a user tone.

The illustration nearby shows the parameters that make up the preset tones and what each parameter does. As can be seen in the illustration, parameters can be divided into four groups, each of which is described in detail below.

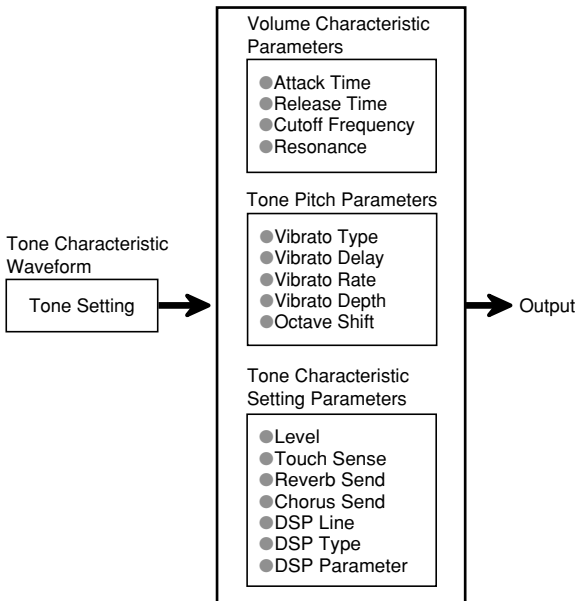

NOTE

- Note that the tone whose parameter you can edit is the one assigned to the channel (1 through 4) that is currently selected with the Synthesizer Mode.

(1) Tone Characteristic Waveform

■ Tone Setting

Specifies which of the preset tones should be used as the original tone.

(2) Volume Characteristic Parameters

These parameters control how the tone changes over time, from when the keyboard key is pressed until the tone decays. You can specify changes in volume and sound characteristics.

■ Attack time

This is the rate or time it takes for the tone to reach its highest volume level. You can specify a fast rate, where the tone reaches its highest volume level immediately, a slow rate where it gradually rises, or something in between.

■ Release time

This is the rate or time it takes for the tone volume to fall to zero. You can specify a release that ranges from a sudden fall to zero, to one that gradually falls to zero.

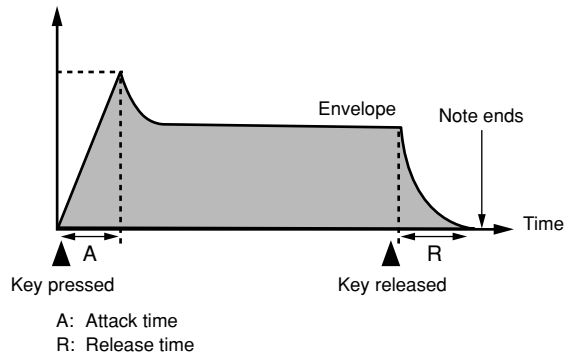

■ Cutoff Frequency

The cutoff frequency is a parameter for adjusting timbre by cutting any frequency that is higher than a specific frequency. A larger cutoff frequency produces a brighter (harder) timbre, while a smaller frequency produces a darker (softer) timbre.

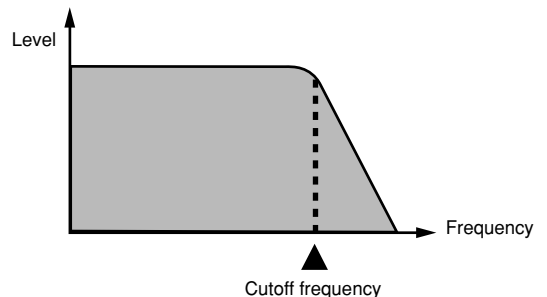



■ Resonance

Resonance enhances the harmonic components in the vicinity of the cutoff frequency, which creates a distinctive sound. A larger resonance value enhances the sound as shown in the figure.

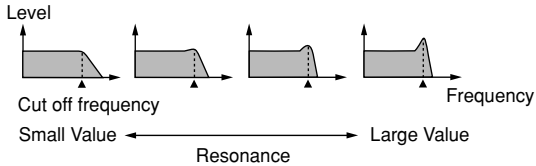

NOTE

- With some tones, a large resonance value can cause distortion or noise during the attack part of the tone.

(3) Tone Pitch Parameters

■ Vibrato Type, Vibrato Delay, Vibrato Rate, Vibrato Depth

These parameters adjust the vibrato effect, which causes periodic changes in the tone.

■ Octave Shift

This parameter controls the octave of all tones.

(4) Tone Characteristic Setting Parameters

■ Level

This parameter controls the overall volume of the tone.

■ Touch Sense

This parameter controls changes in volume and timbre in accordance with the relative amount of pressure applied to the keyboard keys. You can specify more volume for stronger pressure and less volume for a lighter pressure, or you can specify the same volume regardless of how much pressure is applied to the keys.

■ Reverb Send, Chorus Send, DSP Line, DSP Type, DSP Parameter

These parameters control the effects applied to tones.

Saving User Tones

The group of tone numbers from 700 through 799 (User 001 through User 100) is called the “user area” because they are reserved for storage of user tones. After you recall a preset tone and change its parameters to create your own user tone, you can store it in the user area for later recall. You can recall your tones using the same procedure that you use when selecting a preset tone.

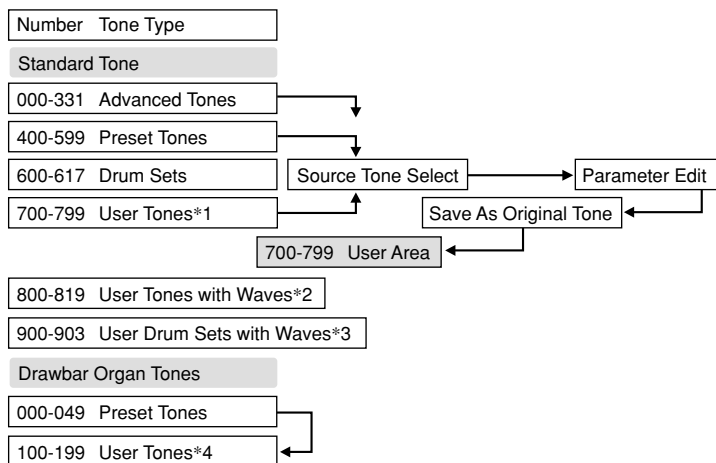

- *1: You can select any Advanced Tone, preset tone, or user tone. User tone areas 700 through 799 initially contain the same data as advanced tones 000 through 099.
- *2: Area where data transferred from computer is stored (see “Using the Music Data Management Software (on the Bundled CD-ROM)” on page E-80). After transfer, you can use the keyboard to edit parameters, but you can only overwrite existing parameters. You cannot save the data to another number.
- *3: Area where data transferred from computer is stored (see “Using the Music Data Management Software (on the Bundled CD-ROM)” on page E-80). Transfer only is allowed, and no parameter editing is allowed.
- *4: User tones created by modifying parameters of one of the preset tones (000 to 049). User drawbar organ tone areas initially contain two sets of the same data as drawbar organ tones types 000 through 049.

NOTE

- You can create an original tone using a user tone that includes a waveform (tone number 800 to 819). In this case, the storage area is the same as the source tone area. For example, an original tone created using tone number 800 as a source tone is stored in user area number 800.

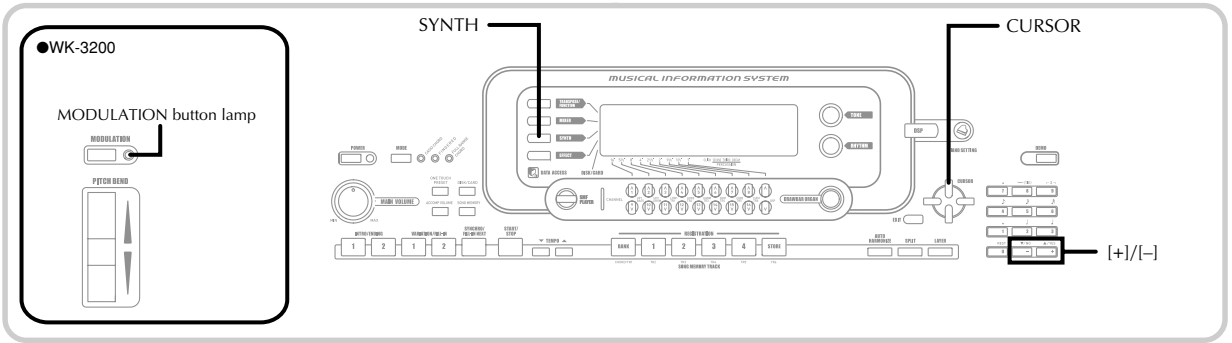

Creating a User Tone

Use the following procedure to select a preset tone and change its parameters to create a user tone.

- 1 First, select the preset tone you want to use as a basis for your user tone.
- 2 Press the SYNTH button.
 - This enters the Synthesizer Mode, which is indicated by the pointer next to SYNTH on the display screen.

Parameter setting value

Currently selected parameter

00 Atk Time

- 3 Use [◀] and [▶] CURSOR buttons to display the parameter whose setting you want to change.

00 VibDelay

- Each press of [◀] or [▶] CURSOR button changes to the next parameter. See “Parameters and Their Settings” on this page for information on setting range for each parameter.

- 4 Use [+] and [-] to change the setting of the currently selected parameter.
 - You can also use the number buttons to input a value to change a parameter setting. See “Parameters and Their Settings” on this page for information on setting range for each parameter.

- 5 After you are finished editing the sound, press the SYNTH button to exit the Synthesizer Mode.

NOTE

- See “Storing a User Tone In Memory” on page E-50 for details on saving user tone data to memory so it is not deleted.

Parameters and Their Settings

The following describes the function of each parameter and provides its setting range.

■ Attack Time (Range: -64 to 00 to +63)

Time it takes before the tone sounds after a key is pressed

-01 Atk Time

■ Release Time (Range: -64 to 00 to +63)

Time the tone continues to sound after a key is released

-07 Rel. Time

■ Cutoff Frequency (Range: -64 to 00 to +63)

High-band cutoff for the harmonic components of the tone

-06 C - off Frq

■ Resonance (Range: -64 to 00 to +63)

Resonance of the tone

-08 Resonan.

■ Modulation Assign (Range: *)

The Modulation Assign parameter specifies which parameters should be affected when you use the keyboard's modulation function. Select "oFF" for any parameters that you do not want affected by the modulation function.

u ib Modulat .

*

Value	Meaning
oFF	Off
vib	Control Change 01h (Modulation)
dp0	Control Change 16 (Normally assigned to DSP Parameter 0.)
dp1	Control Change 17 (Normally assigned to DSP Parameter 1.)
dp2	Control Change 18 (Normally assigned to DSP Parameter 2.)
dp3	Control Change 19 (Normally assigned to DSP Parameter 3.)
dp4	Control Change 80 (Normally assigned to DSP Parameter 4.)
dp5	Control Change 81 (Normally assigned to DSP Parameter 5.)
dp6	Control Change 82 (Normally assigned to DSP Parameter 6.)
dp7	Control Change 83 (Normally assigned to DSP Parameter 7.)

NOTE

- If the Modulation Assign setting of a tone is any setting from dp0 through dp7, that setting is ignored when the tone is used as a layered or split tone. DSP parameter effects are applied to the main tone only.

■ Modulation Depth (Range: 0 to 127) (WK-3200 only)

On the WK-3200, this parameter controls the modulation value when the MODULATION button is pressed. How the MODULATION button functions depends on the modulation assign parameter setting as described below.

If this setting is selected for modulation assign:	Modulation is applied like this:
vib	Modulation is applied to the depth specified by the value assigned to the Modulation Depth parameter as long as the MODULATION button is depressed. Releasing the MODULATION button causes the modulation value to return to the initial default value for the tone being used.
dp0 through dp7	Each press of the MODULATION button toggles modulation between the value assigned to the Modulation Depth Parameter and the initial default value for the tone being used.

000 ModDepth





MODULATION Button Lamp

The MODULATION button lamp lights when the current modulation depth is at its greatest possible setting. This can occur either when the MODULATION button is depressed or released, depending on the current Modulation Depth parameter setting and the initial default modulation depth value of the tone you are currently using.

■ **Vibrato Waveform (Range: See below.)**

Specifies the vibrato waveform.

5 in Vib . Type

Value	Meaning	Waveform
Sin	Sine Wave	
tri	Triangle Wave	
SAU	Sawtooth Wave	
Sqr	Square Wave	

■ **Vibrato Delay (Range: -64 to 00 to +63)**

Specifies the amount of time before vibrato starts.

00 Vib Delay

■ **Vibrato Rate (Range: -64 to 00 to +63)**

Rate (speed) of the vibrato effect

02 Vib . Rate

■ **Vibrato Depth (Range: -64 to 00 to +63)**

Depth of the vibrato effect

12 Vib Depth

■ **Octave Shift (Range: -2 to 0 to +2)**

Up/down octave shift

-1 Oct Shift

■ **Level (Range: 000 to 127)**

This parameter controls the overall volume of the tone. The greater the value, the greater the volume. Setting a level of zero means that the tone does not sound at all.

096 Level

■ **Touch Sensitivity (Range: -64 to 00 to +63)**

This parameter controls changes in the volume of the tone in accordance with the pressure applied to the keyboard keys. A greater positive value increases the volume of the output as pressure increases, while a negative value decreases volume with increased keyboard pressure. A setting of zero specifies no change in output volume in accordance with keyboard pressure.

32 Tch Sense

■ **Reverb Send (Range: 000 to 127)**

This parameter adjusts reverb.

127 Rvb Send

■ **Chorus Send (Range: 000 to 127)**

This parameter adjusts chorus.

112 Cho Send

■ **DSP Line (Settings: on, off)**

This parameter controls whether or not the DSP effect is used.

on DSP Line

DSP Settings

Use the DSP editing screen to select the DSP type and to edit parameters.

- 1 Select a tone, press the SYNTH button, and then configure parameter settings.
- 2 After everything is the way you want, press the [▼] CURSOR button once.
 - This advances to the DSP parameter editing screen.
 - Pressing the [▲] CURSOR button returns to the Synthesizer Mode parameter screen.

This setting specifies DSP parameters. See “DSP Parameters” on page E-28, “Effect List” on page A-14, and “DSP Algorithm List” on page A-16 for more information.

NOTE

- If you store an original tone with the DSP line turned on (page E-49), simply recalling the tone automatically changes the DSP line, DSP type, and DSP parameter settings. This simplifies the recall of original tones that include a DSP effect.

User Tone Creation Hints

The following hints provide helpful advice on making user tone creation a bit quicker and easier.

Use a preset tone that is similar to the one you are trying to create.

Whenever you already have a rough idea of the tone you are trying to create, it is always a good idea to start with a preset tone that is similar.

■ Experiment with various different settings.

There are no real rules about what a tone should sound like. Let your imagination run free and experiment with different combinations. You may be surprised at what you can achieve.

Storing a User Tone In Memory

The following procedure shows how to store a user tone in memory. Once a tone is stored, you can call it up just as you do with a preset tone.

To name a user tone and store it in memory

- 1 Select a preset tone to use as the basis for the user tone, press the SYNTH button to enter the Synthesizer Mode, and make the parameter settings you want.
- 2 After making parameter settings to create the user tone, press [▼] CURSOR button twice.
- 3 Use [+] and [-] to change the user area tone number on the display until the one where you want to store the tone is shown.
 - You can select any tone number from 700 to 799.



- 4 After the tone name is the way you want, press the [▶] CURSOR button to store the tone.
 - Use the [+] and [-] buttons to scroll through letters at the current cursor location.
 - Use the [◀] and [▶] CURSOR buttons to move the cursor left and right.
 - See the page E-92 for information about inputting text.
- 5 Press [▼] CURSOR button to save the user tone.
 - This will display a confirmation message asking whether you really want to save the data. Press the YES button to save the data.
 - The message “Complete” appears momentarily on the display, followed by the tone or rhythm selection screen.
 - To abort the save operation at any time, press the SYNTH button or the EXIT button to exit the Synthesizer Mode. Pressing the SYNTH button again (before selecting another tone) returns to the Synthesizer Mode with all of your parameter settings still in place.

Registration Memory

Registration Memory Features

Registration memory lets you store up to 32 keyboard setups (4 sets x 8 banks) for instant recall whenever you need them. The following is a list of settings that are saved in registration memory.

Registration Memory Settings

- Tone
- Rhythm
- Tempo
- Layer on/off
- Split on/off
- Split point
- Auto Harmonize on/off
- Mixer settings (Channels 1 to 10)
- Effect settings
- Touch Response settings
- Assignable jack setting
- Transpose
- Tuning
- Accompaniment volume setting
- Pitch bend range
- Auto Harmonize type
- MODE button setting
- Synchro standby state
- Mixer Hold
- DSP Hold
- Synthesizer Mode parameters (Modulation Assign, Modulation Depth, Vibrato Waveform, Vibrato Delay, Vibrato Rate, and Vibrato Depth only)

NOTE

- Each bank of registration memory initially contains data when you first use the keyboard. Simply replace the existing data with your own data.
- Registration memory functions are disabled while you are using the SMF Player, Song Memory or demo tune function.
- Registration memory functions are also disabled while you are using the floppy disk drive (WK-3700 only) or card slot (page E-84).

Setup Names

You can assign setups into one of 32 areas, which you can select using BANK buttons 1 through 4 and the four REGISTRATION buttons. Area names range from 1-1 through 8-4 as shown below.

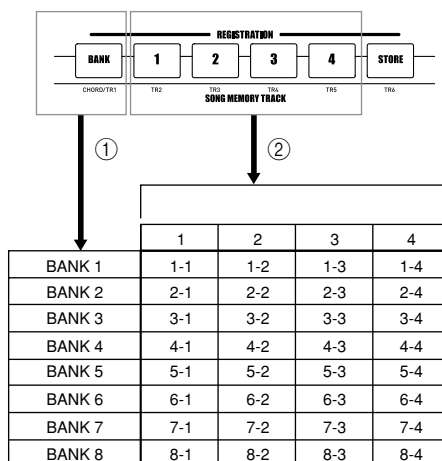

- ① Use the BANK button to select the bank. Each press of BANK cycles through the bank numbers from 1 to 8.
- ② Pressing one of the REGISTRATION buttons (1 to 4) selects the corresponding area in the currently selected bank.

NOTE

- Whenever you save a setup and assign it a setup name, any setup data previously assigned to that name is replaced with the new data.
- You can use the keyboard's MIDI capabilities to save your setup data to a computer or other external storage device. See "Using the Music Data Management Software (on the Bundled CD-ROM)" on page E-80 for details.
- You can save setup data to external media, if you want. See "Saving Data" on page E-82 for more information.

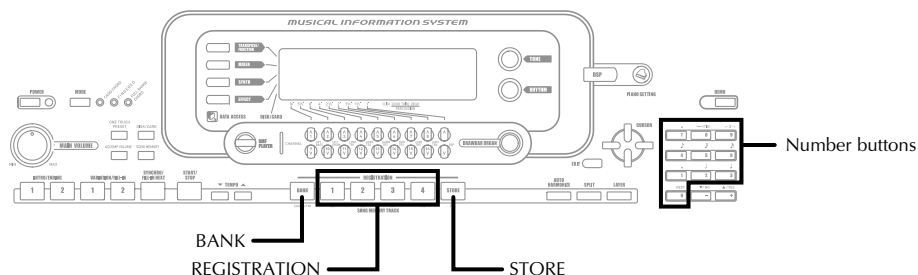

To Save a Setup in Registration Memory

- 1 Select a tone and rhythm, and otherwise set up the keyboard the way you want.
 - See “Registration Memory Settings” on page E-51 for details on what data is stored in the registration memory.
- 2 Use the BANK button or the number buttons to select the bank you want.
 - If you do not perform any operation for about five seconds after pressing the BANK button, the display returns to the contents in step 1, above.
 - Bank 1 selected.

1-- Bank

- 3 While holding down the STORE button, press a REGISTRATION button (1 to 4).
 - The following display appears when you press the 2 button.

1-2 Store

- 4 Release the STORE and REGISTRATION buttons.

NOTE

- The setup is saved as soon as you press a REGISTRATION button in step 3, above.

To Recall a Setup from Registration Memory

- 1 Use the BANK button or the number buttons to select the bank.
 - If you do not perform any operation for about five seconds after pressing the BANK button, the keyboard automatically clears the registration memory recall screen.

1-- Bank

- 2 Press the REGISTRATION button (1 to 4) or number buttons for the area whose setup you want to recall.

1-2 Recall

- The setup name along with the message “Recall” appears on the display.

NOTE

- If you press a REGISTRATION button without using the BANK button to select a bank first, the last bank number selected is used.

Song Memory Function

This keyboard lets you record up to five separate songs in song memory for later playback. There are two methods you can use to record a song: real-time recording where you record the notes as you play them on the keyboard, and step recording where you input chords and notes one-by-one.

NOTE

- Layer and split cannot be used while standing by for recording or while recording is being performed in the Song Memory Mode. Also, layer and split are automatically turned off whenever the keyboard goes into record standby or starts recording.

Tracks

Keyboard song memory records and plays back much like a standard tape recorder. There are a total of six tracks, each of which can be recorded separately. Besides notes, each track can have its own tone number. Then when you play back the tracks together, it sounds like an entire six-piece band. During playback, you can adjust the tempo to change the speed of playback.

	Start	End
Track 1	Auto accompaniment (Rhythm, Bass, Chord 1/2/3), Keyboard play	→
Track 2	Keyboard play	→
Track 3	Keyboard play	→
Track 4	Keyboard play	→
Track 5	Keyboard play	→
Track 6	Keyboard play	→

Melody data recorded in track.

NOTE

- With this keyboard, Track 1 is the basic track, which can be used to record keyboard play, along with Auto Accompaniment. Tracks 2 through 6 can be used for keyboard play, so they are called melody tracks. Tracks 2 through 6 are used to add other parts to what is recorded in Track 1.
- Note that each track is independent of the others. This means that even if you make a mistake while recording, you only need to re-record the track where the mistake was made.
- You can use different Mixer settings for each track (page E-40).

Selecting a Track

Use the SONG MEMORY TRACK buttons marked CHORD/TR1 through TR6 to select the track you want.

Song Memory Track Buttons

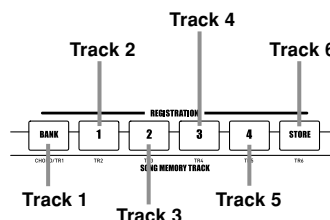

Basic Song Memory operations

The status of the Song Memory changes each time you press the SONG MEMORY button.



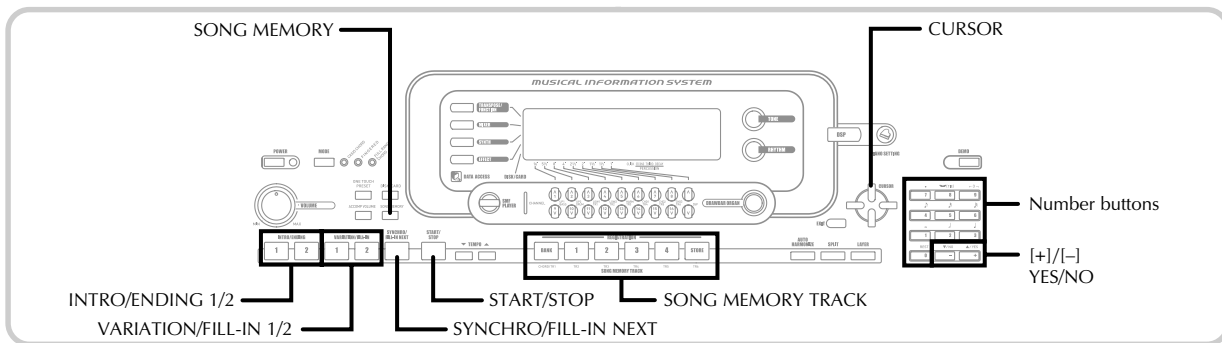

Using Real-time Recording

With real-time recording, the notes you play on the keyboard are recorded as you play them.

To record with real-time recording

- 1 Press the SONG MEMORY button twice to enter real-time record standby.
 - Perform step 2, below, within five seconds after entering record standby.

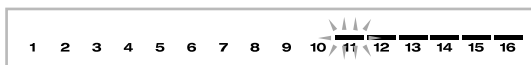

- The level meters for tracks 11 through 16 are shown on the display while the keyboard is in record standby, so you can easily check which tracks are already recorded. See “Level Meter Contents During Record/Edit Standby” on page E-60 for details.

- 2 Use the number buttons to select a song number (0 to 4).

Song number



- The above song number screen remains on the display for about five seconds. If it disappears before you have a chance to select a song number, use the [▼] CURSOR button to re-display it.

- 3 Make the following settings.

- Tone number
- Rhythm number
- Tempo
- MODE button

- 4 Press the START/STOP button to start recording.
 - When recording starts, the REC indicator flashes on the display. After a few moments the indicator stops flashing, and remains on the display.
 - Real-time recording without a rhythm starts. If you want to record with a rhythm, press the INTRODUCTION/ENDING 1/2 or VARIATION/FILL-IN 1/2.
- 5 Play something on the keyboard.
 - You can also record Auto Accompaniment chords by selecting the applicable mode with the MODE button.
 - Optional pedal, pitch bend and modulation operations are also recorded. See “Track 1 Contents After Real-time Recording”.
- 6 Press the START/STOP button to end recording when you are finish playing.
 - If you make a mistake while recording, you can stop the record operation and begin over again from step 1, or you can use the editing function (page E-62) to make corrections.

NOTE

- Using real-time recording to record to a track that already contains recorded data replaces the previous recording with the new one.

Track 1 Contents After Real-time Recording

In addition to keyboard notes and accompaniment chords, the following data is also recorded to Track 1 during real-time recording. This data is applied whenever Track 1 is played back.

- Tone number
- Rhythm number
- INTRO/ENDING 1 button, INTRO/ENDING 2 button, VARIATION/FILL-IN 1 button, VARIATION/FILL-IN 2 button, SYNCRHO/FILL-IN NEXT button operations
- Pedal operations (option)

The following data is recorded in the header whenever you start a recording of a track.

- Mixer settings of other tracks
- Effect type
- Accompaniment volume
- Reverb Level
- Chorus Level
- DSP Hold On/Off
- Mixer Hold On/Off
- Pitch bend wheel operation
- Modulation wheel operation (WK-3700)
- Modulation button operation (WK-3200)
- Pitch bend range

Mixer Mode Settings

Channel 1 Mixer parameters (page E-40) are automatically recorded to Track 1. You can use the Mixer to change each of the parameters.

Memory Capacity

The keyboard has memory for approximately 10,000 notes.

- The measure number and note number flash on the display whenever remaining memory is less than 100 notes.
- Recording automatically stops (and auto-accompaniment and rhythm stops playing if they are being used) whenever memory becomes full.
- Initially, nothing is stored in song memory.

Memory Data Storage

- Whenever you make a new recording, anything previously stored in memory is replaced.
- Turning off the keyboard while a record operation is in progress causes the contents of the track you are currently recording to be lost.
- You can save memory data to external media, if you want. See "Saving Data" on page E-82 for more information.
- Remember that you can dump memory contents to another MIDI device using the procedure described under "Using the Music Data Management Software (on the Bundled CD-ROM)" on page E-80.

Track 1 Real-time Recording Variations

The following describes a number of different variations you can use when recording to Track 1 using real-time recording. All of these variations are based upon the procedure described under "To record with real-time recording" on page E-54.

To start recording with synchro start

In place of step 4, press the SYNCHRO/FILL-IN NEXT button. Auto-accompaniment and recording will both start when you play a chord on the accompaniment keyboard.

To record using an intro, ending, or fill-in

During recording, the INTRO/ENDING 1/2, SYNCHRO/FILL-IN NEXT, and VARIATION/FILL-IN 1/2 buttons (pages E-36 to 37) can all be used as they normally are.

To synchro start Auto Accompaniment with an intro pattern

In place of step 4, press the SYNCHRO/FILL-IN NEXT button and then INTRO/ENDING 1 or INTRO/ENDING 2 button. Auto-accompaniment will start with the intro pattern when you play a chord on the accompaniment keyboard.

To start Auto Accompaniment part way into a recording

In place of step 4, press the SYNCHRO/FILL-IN NEXT button and then play something on the melody keyboard to start recording without Auto Accompaniment. When you reach the point where you want accompaniment to start, play a chord on the accompaniment keyboard to start Auto Accompaniment.

Playing Back from Song Memory

Once you record tracks to song memory, you can play them back to see what they sound like.

To play back from song memory

- 1 Use the SONG MEMORY button to enter playback standby, and then use the number buttons to select a song number (0 to 4).

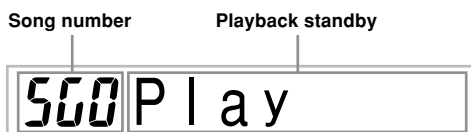

- The above song number screen remains on the display for about five seconds. If it disappears before you have a chance to select a song number, use the [▼] CURSOR button to re-display it.
- 2 Press the START/STOP button to playback the song you selected.
 - You can use the TEMPO buttons to adjust the playback tempo.
 - Press the START/STOP button again to stop playback.

NOTE

- You can play along on the keyboard using layer (page E-65) and split (page E-66) during playback.
- Pressing the START/STOP button to start playback from song memory always starts from the beginning of the song.
- The entire keyboard functions as a melody keyboard, regardless of the MODE button setting.

To turn off a specific track

Press the SONG MEMORY TRACK button of the track you want to turn off, or use the Mixer (Page E-40) to turn off the channel of the track.

Recording Melody and Chords with Step Recording

With step recording, you can record Auto-Accompaniment chords and notes, and even specify note lengths one by one. Even those who find it difficult to play along on the keyboard with an Auto-Accompaniment can create Auto-Accompaniments based on their own original chord progressions. The following shows the type of data that can be recorded in Tracks 1 through 6.

Track 1: Chords and Auto-Accompaniment
Tracks 2 through 6: Keyboard play

With step recording, first record the chords and Auto-Accompaniment in Track 1. Next, record the melody in Tracks 2 through 6.

NOTE

- Use the procedure under "To record to Tracks 2 through 6 using step recording" on page E-59 for details on how to record to Tracks 2 through 6.

To record chords with step recording

- 1 Press the SONG MEMORY button three times to enter step recording standby, and then use the number buttons to select the song number (0 to 4).



- 2 Make the following settings.
 - Rhythm number
 - MODE button
- 3 Press the CHORD/TR1 button, which is one of the SONG MEMORY TRACK buttons, to select Track 1.
 - When recording starts, the REC indicator flashes on the display. After a few moments the indicator stops flashing, and remains on the display.
- 4 Press the SYNCHRO/FILL-IN NEXT button.
- 5 Play a chord.
 - Use the chord play method that is specified by the current MODE button setting (Fingered, CASIO Chord, etc.).
 - When the MODE button is set to Normal, specify the chord using the root input keyboard and chord type input keyboard. See “Specifying Chords in the Normal Mode” on page E-58 for details.

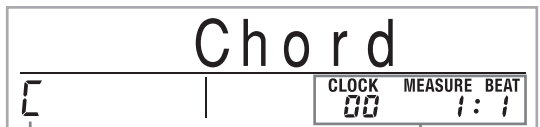

Chord name Measure, beat, and clock at current location*

* 96 clocks = 1 beat

- 6 Input the length of the chord (how long it should be played until the next chord is played).
 - Use the number buttons to specify the length of the chord. See “Specifying the Length of a Note” on page E-58 for details.
 - The specified chord and its length are stored in memory and the keyboard stands by for input of the next chord.
 - Repeat steps 5 and 6 to input more chords.

- 7 After you are finished recording, press the START/STOP button.
 - This enters playback standby for the song you have just recorded.
 - To play back the song at this time, press the START/STOP button.

NOTE

- Use the procedure under “Correcting Mistakes While Step Recording” on page E-60 to correct input mistakes you make during step recording.
- You can add on to a track that already contains recorded data by selecting that track in step 3 of the above procedure. Doing so automatically locates the step recording start point at the first beat immediately following the previously recorded data.
- Inputting “0” as the chord length in steps 5 and 6 of the above procedure specifies a rest, but the rest is not reflected in the accompaniment contents when the accompaniment is played.

Track 1 Contents After Step Recording

In addition to chords, the following data is also recorded to Track 1 during step recording. This data is applied whenever Track 1 is played back.

- Rhythm number
- INTRO/ENDING 1 button, INTRO/ENDING 2 button, VARIATION/FILL-IN 1 button, VARIATION/FILL-IN 2 button, SYNCHRO/FILL-IN NEXT button operations

NOTE

- You can also use number buttons 1 through 7, and button 9 to specify the button release timing for the VARIATION/FILL-IN 1, VARIATION/FILL-IN 2, and SYNCHRO/FILL-IN NEXT buttons. For more information, see “Specifying the Length of a Note” on page E-58. Specifying release timing specifies that the applicable button remains depressed for a particular amount of time. If you do not specify the release timing, it is assumed that the button is pressed and then immediately released.

Specifying Chords in the Normal Mode

When the MODE button is set to Normal during step recording, you can specify chords using a method that is different from CASIO Chord and Fingered fingerings. This chord specification method can be used to input 18 different chord types using only two keyboard keys, so chords can be specified even if you don't know how to actually play them.

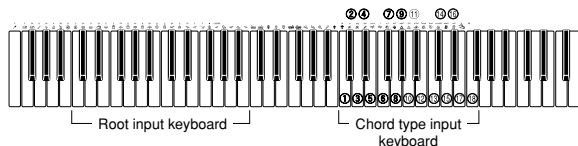

- | | |
|-----------------------|---------------------------|
| ① Major | ⑩ Seventh flat five |
| ② Minor | ⑪ Minor seventh flat five |
| ③ Augmented | ⑫ Seventh suspended four |
| ④ Diminished | ⑬ Diminished seventh |
| ⑤ Suspended four | ⑭ Minor add ninth |
| ⑥ Seventh | ⑮ Add sixth |
| ⑦ Minor seventh | ⑯ Minor sixth |
| ⑧ Major seventh | ⑰ Sixth |
| ⑨ Minor major seventh | ⑱ Sixth ninth |

To specify a chord, hold down the key on the root input keyboard that specifies the root, and press the key in the chord type input keyboard to specify the chord type. When inputting a chord with a specified bass note, pressing two keys of the root input keyboard causes the lower note to be specified as a bass note.

Example 1: To input Gm7, hold down G on the root input keyboard and press the m7 key on the chord type input keyboard.

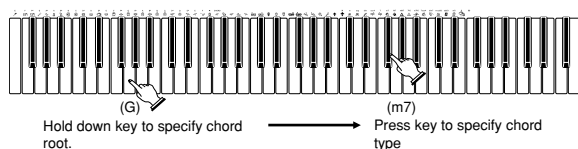

Example 2: To input Gm/C, hold down C and G on the root input keyboard and press the m key on the chord type input keyboard.

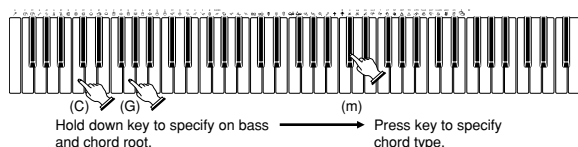

Specifying the Length of a Note

During step recording, the number buttons are used to specify the length of each note.

Note lengths

Use number buttons [1] through [6] to specify whole notes (♩), half notes (♪), quarter notes (♫), eighth notes (♬), 16th notes (♭), and 32nd notes (♮).

Example: To specify a quarter note (♫), press [3].

Dots (.) and triplicates (≡)

While holding down the [7] (dot) or [9] (triplicate), use buttons [1] through [6] to input the lengths of the notes.

Example: To input a dotted eighth note (♫.), hold down [7] and press [4].

Ties

Input the first and then the second note.

Example: To input ♫ ♫, press [4] and then [8]. Next, press [5]. This note will be tied to the next note you input (16th note in this example).

Rest

Hold down [0] and then use number buttons [1] through [9] to specify the length of the rest.

Example: To input an eighth note rest, hold down [0] and press [4].

- Pressing the [▶] CURSOR button inputs rests up to the beginning of the next measure.

Track 1 Step Recording Variations

The following describes a number of different variations you can use when recording to Track 1 using step recording. All of these variations are based upon the procedure described under "To record chords with step recording" on page E-57.

To start accompaniment with an intro pattern

In step 4, press INTRO/ENDING 1 or INTRO/ENDING 2 button after the SYNCHRO/FILL-IN NEXT button.

To switch to a rhythm variation

In step 5, press VARIATION/FILL-IN 1 or VARIATION/FILL-IN 2 button immediately before inputting the chord.

To insert a fill in

In step 5, press VARIATION/FILL-IN 1 or VARIATION/FILL-IN 2 button at the measure or beat immediately before the chord or beat where you want to insert the fill in.

To insert an ending

In step 5, press INTRO/ENDING 1 or INTRO/ENDING 2 button at the measure or beat immediately before the chord where you want to insert the ending.

IMPORTANT!

- The length of the ending depends on the rhythm you are using. Check the length of the pattern you are using and set the length of the chord accordingly in step 6. Making the chord too short in step 6 can result in the ending pattern being cut off.

To step record chords without rhythm

Skip step 4. The specified chord of the length specified by the number buttons is recorded. A rest can be specified here, so an original chord pattern can be created.

To add chord accompaniment part way through rhythm play

In place of step 4 at the start of the recording, press VARIATION/FILL-IN 1 or VARIATION/FILL-IN 2 button and input rests. Then in step 5, input the chords. Only rhythm is played where you input the rests, and then chord play starts after the rests.

Recording Multiple Tracks

Track 1 of the keyboard's song memory records Auto Accompaniment and keyboard play. In addition, there are five other melody tracks that you can use to record melody parts only. You can record different tones to the melody tracks and build a full ensemble of instruments for your recordings. The procedure you use for recording to Tracks 2 through 6 is identical to the one you use when recording to Track 1.

To record to Tracks 2 through 6 using real-time recording

You can record to Tracks 2 through 6 while playing back what you originally recorded on Track 1 and any other tracks that are already recorded.

- 1 Press the SONG MEMORY button twice to enter record standby, and then use the number buttons to select a song number (0 to 4).
 - The song number you select should be the one where you previously input Track 1.
- 2 Use the SONG MEMORY TRACK buttons to select the track you want to record to (2 through 6).
 - While the keyboard is in record standby, the display shows the level meters for channels 11 through 16, so you can check which tracks have already been recorded. See "Level Meter Contents During Record/Edit Standby" on page E-60 for details.
- 3 Make the following settings.
 - Tone number
 - Tempo

- 4 Press the START/STOP button to start recording.
 - At this time, the contents of any tracks that are already recorded start to play back.
 - Optional pedal, pitch bend and modulation operations are also recorded.
- 5 Use the keyboard to play what you want to record the track you selected.
- 6 Press the START/STOP button to end recording when you are finished.

Track Contents After Real-time Recording

In addition to keyboard notes, the following data is also recorded to the selected track during real-time recording. This data is applied whenever the track is played back.

- Tone number
- Pedal operations (option)

The following data is recorded in the header whenever you start a recording of a track.

- Mixer settings of other tracks
- Effect type
- Accompaniment volume
- Reverb Level
- Chorus Level
- DSP Hold On/Off
- Mixer Hold On/Off
- Pitch bend wheel operation
- Modulation wheel operation (WK-3700)
- Modulation button operation (WK-3200)
- Pitch bend range

To record to Tracks 2 through 6 using step recording

This procedure describes how to input notes one-by-one, specifying each note's pitch and length.

- 1 Press the SONG MEMORY button three times to enter real-time record standby, and then use the number buttons to select a song number (0 to 4).
 - The song number you select should be the one where you previously input Track 1.

50 | Step Rec

- 2 Use the SONG MEMORY TRACK buttons to select the track you want to record to (2 through 6).

Example: Select Track 2.



- 3 Specify a tone number.

- Pressing a TONE button or the DRAWBAR ORGAN button displays the tone number and name on the display. You can then use the number buttons, or the [+] (increase) and [-] (decrease) buttons to change the tone.
- After changing the tone number, press any keyboard key to clear the tone number and name screen, and return to the note input screen.

- 4 Use the keyboard keys to input notes, or the [0] button to input rests.

- At this time, the display shows the keyboard pressure (velocity). Use the [+] (increase) and [-] (decrease) buttons to change the velocity.
- You can also input a chord.

- 5 Use the number buttons to input the length of the note or rest (page E-58).

- 6 Repeat steps 4 and 5 to input more notes.

- 7 Press the START/STOP button to end recording when you are finished.

NOTE

- Use the procedure under “Correcting Mistakes While Step Recording” on this page to correct input mistakes you make during step recording.
- You can add on to a track that already contains recorded data by selecting that track in step 2 of the above procedure. Doing so automatically locates the step recording start point at the first beat immediately following the previously recorded data.
- Whenever you are recording to Tracks 2 through 6, the entire keyboard functions as a melody keyboard, regardless of the current MODE button setting.
- When playing back data recorded with Advanced Tones at the beginning of multiple tracks, the keyboard uses the DSP type of the Advanced Tone that is recorded in the track with the largest track number.
- When playing back a track that was recorded with an Advanced Tone selected, they may be a slight delay before the first note of the track sounds. If this happens, try to insert a very short rest at the beginning of the track.

Track Contents After Step Recording

In addition to notes and rests, the following data is also recorded to the track during step recording. This data is applied whenever the track is played back.

- Tone number

Level Meter Contents During Record/Edit Standby

Channels 11 through 16 correspond to Tracks 1 through 6. Whenever the keyboard is in record or edit (page E-62) standby, the level meter display shows which tracks already contain recorded data and which are still empty. Tracks with four lit segments already contained recorded data, while tracks with one lit segment are not yet recorded.



Correcting Mistakes While Step Recording

Memory data can be thought of as a musical score that progresses from left to right, with the input point normally at the far right of the recorded data.

The procedure described here lets you move the input point to the left in order to make changes in data you have already input. Note, however, that moving the input point to the left and changing data automatically deletes all of the data recorded to the right of the input point.

To correct mistakes while step recording

- Without exiting step recording, use the [◀] CURSOR button to move the input point to the left.
 - The REC indicator disappears from the display, and the STEP indicator flashes.

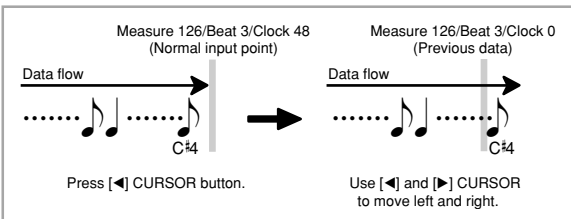
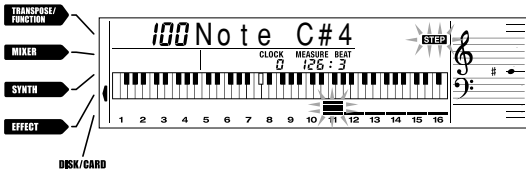

- Monitoring the data on the display, use [◀] and [▶] CURSOR buttons to move the input point to the data you want to change.

Example: To re-record all note data following the note A3 located at Measure 120, Beat 1, Clock 0.

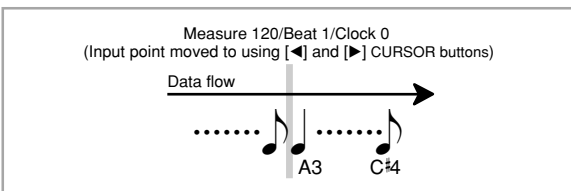
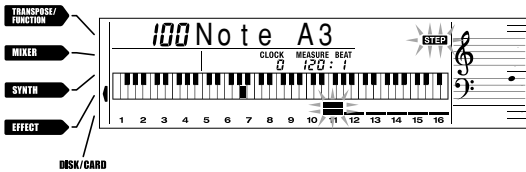

- Press the [▼] CURSOR button.

Rewrite?

- Press the YES button.
 - This deletes all data from the location you specified and enters step record standby.
 - Pressing the [▲] CURSOR button or the NO button cancels deleting the data.

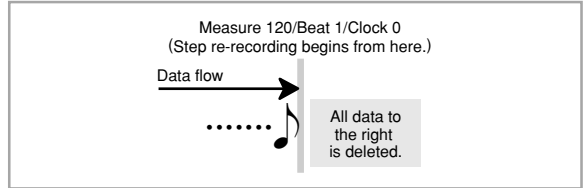

NOTE

- When you reach the end of the recording by pressing the [▶] CURSOR button, the “REC” indicator appears and the “STEP” indicator flashes on the display, indicating that you can add more data using step recording.

To delete specific note data

- Perform steps 1 and 2 under “To correct mistakes while step recording” above to display the note you want to delete.
- Press the [▼] CURSOR button twice.
- In response to the “Delete?” message that appears on the screen, press the YES button to delete the displayed note.

Editing Memory Contents

After you record to keyboard memory, you can recall individual notes and parameter settings (such as tone number) and make any changes you want. This means you can correct misplayed notes, make changes in tone selections, etc.

The following types of data can be edited.

- Note intensity
- Notes
- Chords
- Tone numbers
- Rhythm number
- INTRO/ENDING 1 button, INTRO/ENDING 2 button, VARIATION/FILL-IN 1 button, VARIATION/FILL-IN 2 button, SYNCHRO/FILL-IN NEXT button operations

To edit memory contents

- 1 Press the SONG MEMORY button three times to enter step recording standby, and then use the [+] and [-] buttons to select a song number (0 to 4).



- 2 Use the SONG MEMORY TRACK buttons to select the recorded track that you want to edit.
- 3 Press the [◀] CURSOR button to enter the editing mode.
 - The REC indicator disappears from the display, and the STEP indicator flashes.

- 4 Use the [◀] and [▶] CURSOR buttons to move to the location in track where the note or parameter you want to change is located.

Note editing example

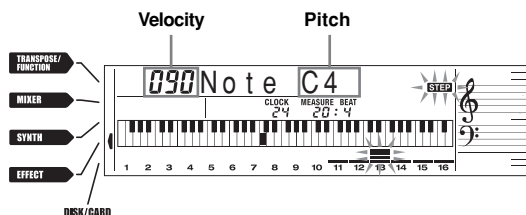

- 5 Make any changes in the value that you want.
 - The actual procedures you use to change a parameter depend on the type of data it contains. See "Editing Techniques and Display Contents" on page E-63 for details.
- 6 Repeat steps 4 and 5 to edit other parameters.
- 7 Press the START/STOP button to end editing when you are finished.

NOTE

- The only parameters that can be edited for Tracks 2 through 6 are notes and tone numbers.
- In the case of real-time recording, you later can change tone numbers you specified while recording to Tracks 1 through 6 is in progress.
- You can only change tone numbers that were originally set for Tracks 2 through 6 using step recording.
- In the case of real-time recording, you later can change rhythm numbers you specified while recording to Track 1 is in progress.
- You can only change rhythm numbers that were originally set for Track 1 using step recording.
- You cannot use the edit procedure to add more data to a recording.
- You cannot move portions of a recording to a different location within the recording.
- Note lengths cannot be changed.

Editing Techniques and Display Contents

The following describes the editing techniques you can use to change the various parameters stored in memory.

To change the key pressure (velocity) of a note

Use the number buttons or [+] and [-] to adjust the key pressure.

110 Note G4

To change the pitch of a note

Input a new note on the keyboard or use [+] and [-] buttons to change the pitch of a note. The pitch you specify here is reflected in the keyboard and the notes shown in the staff on the display.

110 Note G4

IMPORTANT!

- Whenever editing memory contents, never change a note so it is identical to the note before or after it. Doing so may alter the length of the changed note and the note before or after it. Should this happen, you will have to re-record the entire track.

To change a chord

Use the chord fingering method selected by the MODE button (FINGERED, CASIO CHORD, etc.) to input a chord.

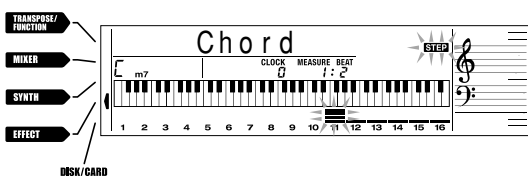

To change a tone number

Use the number buttons or [+] and [-] buttons to change a tone number.

TONE 000 St . Gr Pno

NOTE

- In the case of real-time recording, you later can change tone numbers you specified while recording to Tracks 1 through 6 is in progress.
- You can only change tone numbers that were originally set for Tracks 2 through 6 using step recording.

To change a rhythm number

Use the number buttons or [+] and [-] buttons to change a rhythm number.

RHYTHM 026 Pop 1

NOTE

- In the case of real-time recording, you later can change rhythm numbers you specified while recording to Track 1 is in progress.
- You can only change rhythm numbers that were originally set for Track 1 using step recording.

To change a rhythm controller operation*

* INTRO/ENDING 1 button, INTRO/ENDING 2 button, VARIATION/FILL IN 1 button, VARIATION/FILL IN 2 button, SYNCHRO/FILL IN NEXT button operations
Press the rhythm controller button you want to change to.

Int / End 1

Editing a Song

You can perform the following operations in the song editing mode.

- Delete a song
- Delete a track
- Song header data rewrite (Panel Record)

To delete a song

- 1 Press the SONG MEMORY button once to enter playback standby.
- 2 Use the [+] and [-] buttons to select the number of the song you want to delete.
- 3 Press the [▼] CURSOR button. If there is no song number on the display, press the [▼] CURSOR button twice.
 - This displays the song delete screen.
- 4 Press the YES button.
 - This causes the message "Sure?" to appear, confirming whether you really want to delete the song.
- 5 Press the YES button to delete the song and return to playback standby.

To delete a specific track

- 1 Press the SONG MEMORY button once to enter playback standby.
- 2 Use the [+] and [-] buttons to select the number of the song that contains the track you want to delete.
- 3 Press the [▼] CURSOR button twice. If there is no song number on the display, press the [▼] CURSOR button three times.
 - This displays the song delete screen.

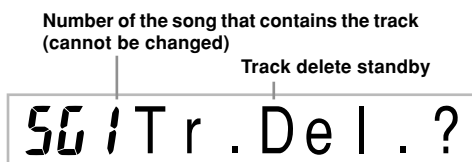

- 4 Use the SONG MEMORY TRACK buttons to select the recorded track or tracks whose data you want to delete.

Track delete standby

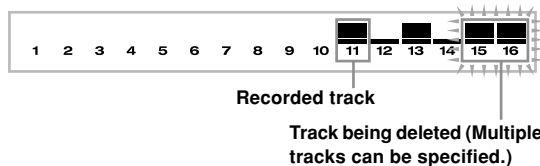

- You can specify more than one track for deletion by pressing more than one track select button.
 - To deselect a track, simply press its track select button again.
- 5 Press the YES button.
 - This causes the message "Sure?" to appear, confirming whether you really want to delete the track.
 - 6 Press the YES button to delete the track.

NOTE

- You cannot change the song number while in track delete standby.
- Pressing the SONG MEMORY button while in track delete standby returns to record standby.

To rewrite song header data (Panel Record)

You can use a procedure called "Panel Record" to change the initial Mixer, tempo and other settings stored in the song header.

- 1 Press the SONG MEMORY button once to enter playback standby.
- 2 Use the [+] and [-] buttons to select the number of the song that contains the header data you want to rewrite.
- 3 Make the changes you want to the header data.
- 4 Press the [▼] CURSOR button three times.
 - This displays the song delete screen.
- 5 Press the YES button to rewrite the header data.

Keyboard Settings

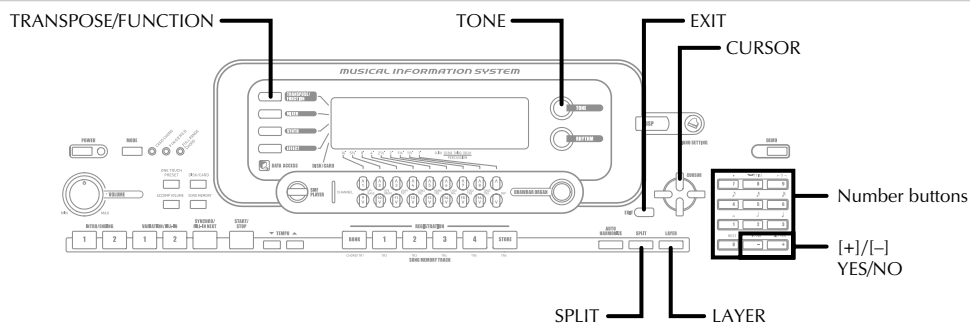

Parts

Up to four parts (numbered 1 through 4) can be used simultaneously during keyboard play. These parts can be used by the layer and split functions explained below.

- Part 1: Main tone part
- Part 2: Layered tone part
- Part 3: Split tone part
- Part 4: Layered and split tone part

Using Layer

Layer lets you assign two different tones (a main tone and a layered tone) to the keyboard, both of which play whenever you press a key. For example, you could layer the GM FRENCH HORN tone on the GM BRASS tone to produce a rich and brassy sound.

LAYER

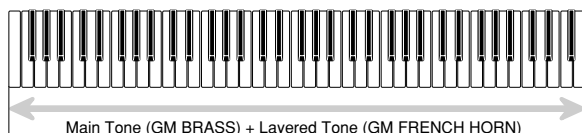

To layer tones

- 1 First select the main tone.
Example: To select “461 GM BRASS” as the main tone, press the TONE button and then use the number buttons to input 4, 6 and then 1.

TONE **461 Brass G**

- 2 Press the LAYER button.

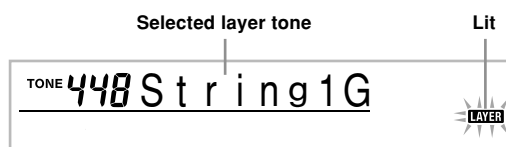

- 3 Select the layered tone.
Example: To select “460 GM FRENCH HORN” as the layered tone, use the number buttons to input 4, 6 and then 0.

TONE **460 Fr Horn G**

- 4 Now try playing something on the keyboard.
 - Both tones are played at the same time.
- 5 Press the LAYER button again to unlayer the tones and return the keyboard to normal.

NOTE

- Turning on layering switches the currently selected part from Part 1 to Part 2, and displays the layered tone. At that time, you can use the [◀] and [▶] CURSOR buttons to switch between parts. Turning off layering returns to Part 1.
- The main tone sounds over Channel 1, while the layered tone sounds over Channel 2. You can also use the Mixer to change the tone and volume settings for these channels.
- Note that layering is not possible during record standby or recording in the Song Memory Mode, or while you are using the SMF Player Mode.

Using Split

With split you can assign two different tones (a main tone and a split tone) to either end of the keyboard, which lets you play one tone with your left hand and another tone with your right hand. For example, you could select GM STRINGS 1 as the main (high range) tone and GM PIZZICATO as the split (low range) tone, putting an entire string ensemble at your fingertips.

Split also lets you specify the split point, which is the location on the keyboard where the changeover between the two tones occurs.

NOTE

- Leave the MODE button in the Normal or FULL RANGE CHORD position.

SPLIT

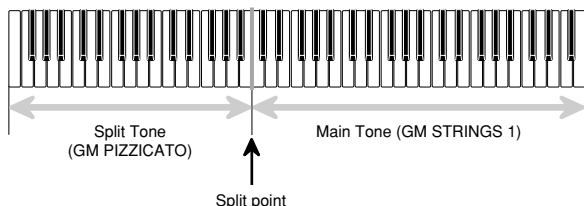

To split the keyboard

- 1 First select the main tone.

Example: To select “448 GM STRINGS 1” as the main tone, press the TONE button and then use the number buttons to input 4, 4 and then 8.

448 String 1G

- 2 Press the SPLIT button.

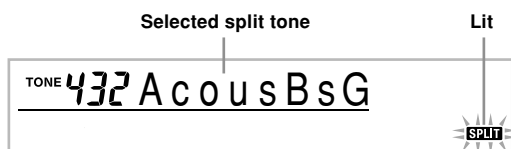

- 3 Select the split tone.

Example: To select “445 GM PIZZICATO” as the split tone, use the number buttons to input 4, 4 and then 5.

445 PizzcatG

- 4 Specify the split point. While holding down the SPLIT button, press the keyboard key where you want the leftmost key of the high end range to be.
Example: To specify G3 as the split point, press the G3 key.

G3

- 5 Now try playing something on the keyboard.
 - Every key from F#3 and below is assigned the GM PIZZICATO tone, while every key from G3 and above is assigned the GM STRINGS 1 tone.
- 6 Press the SPLIT button again to unsplit the keyboard and return it to normal.

NOTE

- Turning on split switches the currently selected part to Part 3, and displays the split tone. At that time, you can use the [◀] and [▶] CURSOR buttons to switch between parts. Turning off split returns to Part 1.
- The main tone sounds over Channel 1, while the split tone sounds over Channel 3. You can also use the Mixer to change the tone and volume settings for these channels.
- Note that split is not possible during record standby or recording in the Song Memory Mode, or while you are using the SMF Player Mode.
- When the MODE button is set to CASIO CHORD or FINGERED, the accompaniment keyboard range is in accordance with the split point you specify with the above procedure.

Using Layer and Split Together

You can use layer and split together to create a layered split keyboard. It makes no difference whether you layer tones first and then split the keyboard, or split the keyboard and then layer tones. When you use layer and split in combination, the high range of the keyboard is assigned two tones (main tone + layered tone), and the low range two tones (split tone + layered split tone).

LAYER SPLIT

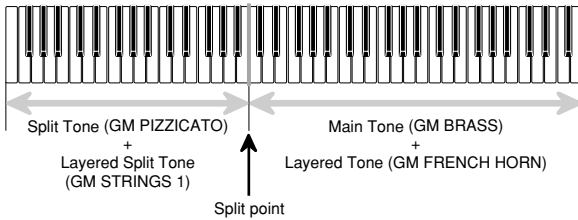

To split the keyboard and then layer tones

- 1 Press the TONE button and then input the tone number of the main tone.
Example: To set “461 GM BRASS” as the main tone.

461 Brass G

- 2 Press the SPLIT button and then input the number of the split tone.
Example: To set “445 GM PIZZICATO” as the split tone.

445 Pizzcat G

- After specifying the split tone, press the SPLIT button to unsplit the keyboard.

- 3 Press the LAYER button and then input the number of the layered tone.
Example: To set “460 GM FRENCH HORN” as the layered tone.

460 Fr Horn G

- 4 Press the SPLIT button or the LAYER button so both of the SPLIT and LAYER indicators are displayed.

- 5 Input the number of the layered split tone.
Example: To specify the “448 GM STRINGS 1” tone, enter 4, 4, 8.

448 String1G

- 6 While holding down the SPLIT button, press the keyboard key where you want the lowest note (the leftmost key) of the upper range (right side range) to be.

- 7 Play something on the keyboard.
 - Press the LAYER button to unlayer the keyboard, and the SPLIT button to unsplit it.

NOTE

- Turning on layer+split switches the currently selected part to Part 4, and displays the layered tone. At that time, you can use the [◀] and [▶] CURSOR buttons to switch between parts. Turning off layer returns to Part 3, while turning off split returns to part 2. Turning off both layer and split returns to Part 1.
- The main tone sounds over Channel 1, the layer tone over Channel 2, the split tone over Channel 3, and the layer/split tone over Channel 4. You can also use the Mixer to change the tone and volume settings for these channels.

Transposing the Keyboard

Transpose lets you raise and lower the overall key of the keyboard in semitone units. If you want to play an accompaniment for a vocalist who sings in a key that's different from the keyboard, for example, simply use transpose to change the key of the keyboard.

To transpose the keyboard

- 1 Press the TRANSPOSE/FUNCTION button.
 - This causes a pointer to appear on the display next to TRANSPOSE/FUNCTION, and displays the transpose setting screen.

00 Trans .

- 2 Use [+] and [-] to change the transpose setting of the keyboard.

Example: To transpose the keyboard five semitones upwards.

05 Trans .

- Pressing the TRANSPOSE/FUNCTION button exits the transpose screen.

NOTE

- The keyboard can be transposed within a range of -24 (two octave downwards) to +24 (two octave upwards).
- The transpose setting also affects playback from song memory and Auto Accompaniment.
- The allowable pitch range you can transpose within depends on the tone you are using. If a transpose operation causes a note to be outside of the pitch range for the tone being used, the keyboard automatically plays the same note in the nearest octave that falls within the pitch range of the tone you are using.

Using Touch Response

When touch response is turned on, the relative volume of sound output by the keyboard is varied in accordance with the amount of pressure applied, just like an acoustic piano.

To turn touch response on and off

- 1 Press the TRANSPOSE/FUNCTION button.
 - This causes a pointer to appear on the display next to TRANSPOSE/FUNCTION.
- 2 Use the [◀] and [▶] CURSOR buttons to display the touch response setting screen.

2 Touch

- 3 Use the [+] and [-] buttons to select the touch response sensitivity level.
 - "1" outputs powerful sound even with light key pressure, while "3" requires very heavy key pressure to output powerful sound.
 - Pressing [+] and [-] at the same time returns sensitivity to the "2" setting.
 - When you select "oFF", the tone does not change regardless of how much pressure you apply to the keyboard.

NOTE

- Touch response not only affects the keyboard's internal sound source, it also is output as MIDI data.
- Song Memory playback, accompaniment, and external MIDI note data do not affect the touch response setting.



Tuning the Keyboard

The tuning feature lets you fine tune the keyboard to match the tuning of another musical instrument.

To tune the keyboard

- 1 Press the TRANSPOSE/FUNCTION button.
- 2 Use the [◀] and [▶] CURSOR buttons to display the tuning screen.



00 Tune

- 3 Use [+] and [-] to change the tuning setting of the keyboard.
Example: To lower the tuning by 20.



-20 Tune

- Pressing the TRANSPOSE/FUNCTION button exits the transpose screen.

NOTE

- The keyboard can be tuned within a range of -99 cents to +99 cents.
*100 cents is equivalent to one semitone.
- The tuning setting also affects playback from song memory and Auto Accompaniment.

Changing Other Settings

Setting Types

The table below shows the parameters whose settings you can change.

Setting menu	Description	Page
Transpose (Trans.)	Adjusts of overall keyboard tuning by semitone units.	E-68
Auto Harmonize (AutoHarm)	Selects the Auto Harmonize Type	E-72
Touch Response (Touch)	Specifies of how sound should change with keyboard pressure.	E-68
Tune (Tune)	Fine adjustment of overall keyboard tuning.	E-69
Contrast (Contrast)	Adjusts display brightness.	E-73
Assignable Jack (Jack)	Assigns effects to pedals.	E-73
Mixer Hold (MixHold)	Turns mixer hold on or off.	E-73
DSP Hold (DSP Hold)	Turn DSP hold on or off.	E-73
MIDI (MIDI)	MIDI settings	E-73
Delete/Initialize (Del/Init)	Initialization can be used to return keyboard parameters to their initial factory default settings, or to delete all data currently in keyboard memory.	E-73

NOTE

- The above settings are all saved whenever you turn off the keyboard. For details, see “Memory Contents” on page E-16.
- MIDI settings and Delete/Initialize settings are disabled while you are using the SMF Player or Song Memory function.

To use the keyboard settings menu

- 1 Press the TRANSPOSE/FUNCTION button.
 - This causes a pointer to appear on the display next to TRANSPOSE/FUNCTION.
- 2 Use the [◀] and [▶] CURSOR buttons, and the [▲] and [▼] CURSOR buttons to recall the items whose settings you want to change.

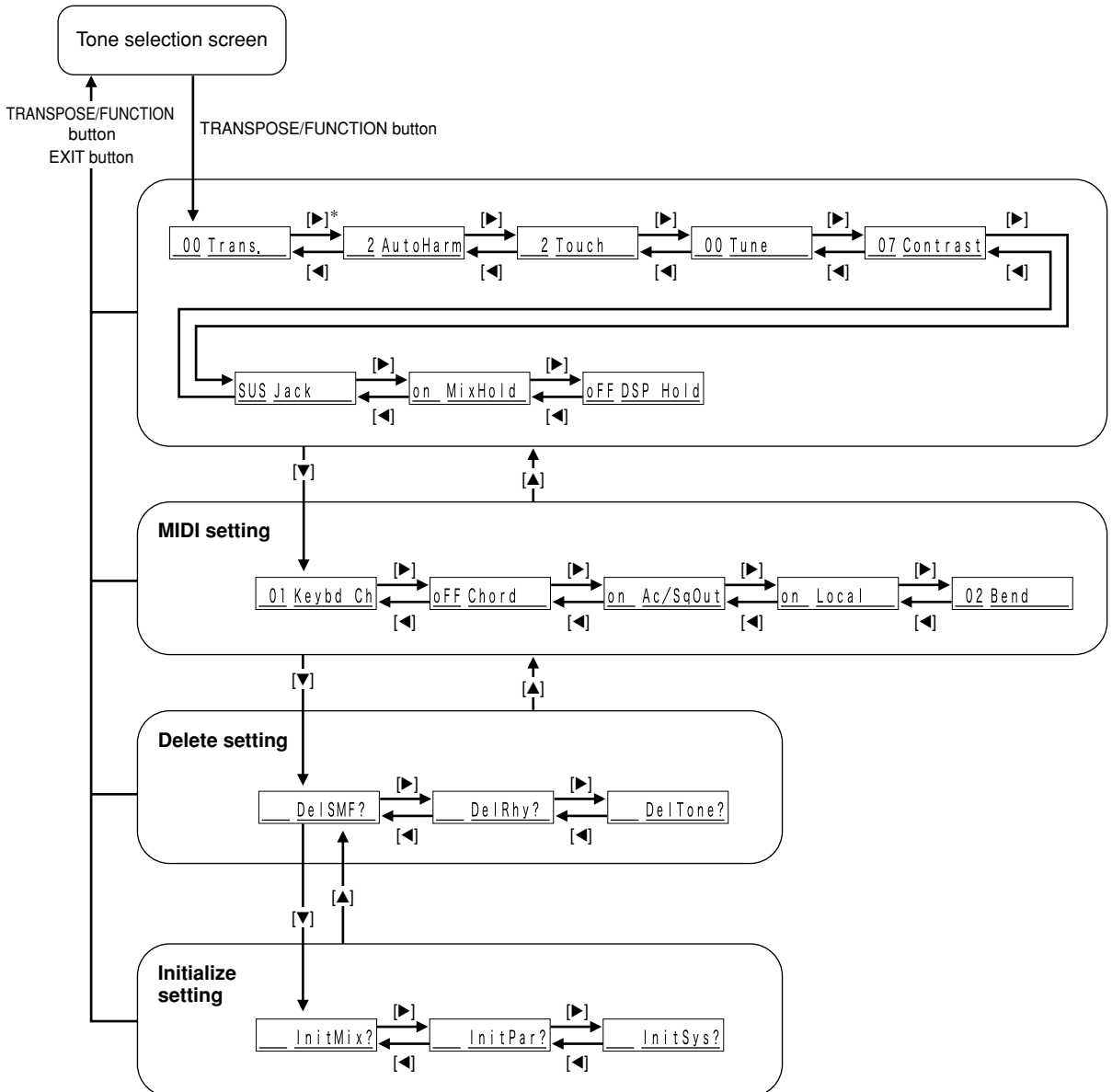

* [▲]: [▲] CURSOR button [◀]: [◀] CURSOR button
 [▼]: [▼] CURSOR button [▶]: [▶] CURSOR button

- 3 Use the [+] and [-] buttons or the number buttons to change the values.
 - Settings you make are applied even if you do not press the EXIT button.
 - See the following section titled “Setting Menu Items” for details on each setting.
 - After making the settings you want, press the TRANSPOSE/FUNCTION button or EXIT button to return to the tone or rhythm selection screen.

■ In case of a delete or initialize procedure

- 4 Press the YES button.
 - This displays the user area number and data name of the data to be deleted.
 - The data size value represents kilobyte units.
- 5 Now use the number buttons, or the [+] (increase) and [-] (decrease) buttons to select the data you want.
- 6 Press the [▼] CURSOR button.
 - This causes the message “Sure?” to appear, confirming whether you really want to perform the delete or initialize operation.
- 7 Press the YES button to complete the operation.
 - This performs the delete or initialize operation and returns to the step 5 screen.
- 8 After making the settings you want, press the TRANSPOSE/FUNCTION button or EXIT button to return to the tone or rhythm selection screen.

IMPORTANT!

- It can take about 40 seconds to perform a delete or initialize procedure after you pressing the YES button in step 7 above. The message “Pls Wait” will remain on the display to indicate that a procedure is being performed. Never try to perform any operation while “Pls Wait” is displayed. Performing any operation can damage the keyboard’s memory and cause it to malfunction.

Setting Menu Items

■ Auto Harmonize Types

You can select from among the 10 different types of auto harmonize listed below.

No.	Type (Parameter Name)	Description
0	Duet1	Adds a 1-part harmony to keyboard play.
1	Duet2	Adds a 1-part harmony to keyboard play. Duet2 harmony is more open than Duet1.
2	Country	Adds a country-flavor harmony to keyboard play.
3	Octave	Adds notes one octave below notes played on the keyboard.
4	5th	Adds fifth notes above notes played on the keyboard.
5	3-Way Open	Adds two open harmony parts to notes played on the keyboard (creating three-part harmony).
6	3-Way Close	Adds two close harmony parts to notes played on the keyboard (creating three-part harmony).
7	Strings	Adds harmony suitable for strings.
8	Block	Adds block chord notes.
9	Big Band	Adds harmony suitable for big band play.

Other Settings

Setting menu	Range	Default	Description
Contrast (Contrast)	00 to 15	07	Adjusts display contrast.
Assignable Jack (Jack)	SUS	SUS	Assigns the sustain pedal effect to a pedal.
	SoS	—	Assigns the sostenuto pedal effect to a pedal.
	SFt	—	Assigns the soft pedal effect to a pedal.
	rhy	—	Assigns the START/STOP button function to a pedal.
Mixer Hold (MixHold)	on/oFF	oFF	When Mixer Hold is turned on, the parameters of accompaniment parts (Part 6 through Part 10) cannot be modified by accompaniment data.
DSP Hold (DSP Hold)	on/oFF	oFF	on: Current DSP line setting is maintained, even when the tone is changed. oFF: Changing the tone switches to the DSP line setting of the new tone.

MIDI Setting

Setting menu	Range	Default	Description
Keyboard Channel (Keybd Ch)	01 to 16	01	Specifies the send channel for main tone play.
MIDI In Chord Judge (Chord)	on/oFF	oFF	Specifies whether accompaniment range MIDI Note On messages received from an external device should be interpreted as auto accompaniment chords.
Accomp/Song MIDI Out (Ac/SgOut)	on/oFF	oFF	Specifies whether this keyboard's auto accompaniment or song memory is sent as MIDI messages.
Local Control Setting (Local)	on/oFF	on	Specifies whether the keyboard should sound the parts played on it.
Pitch Bend Range (Bend)	00 to 12	12	Specifies the maximum change in a tone that can be applied using the PITCH BEND wheel. The setting range is 00 (no change) to 12 (12 semitones).

Delete/Initialize Settings

Setting menu	Range	Default	Description
SMF Delete	—	—	Deletes selected SMF data.
User Rhythm Delete	—	—	Deletes selected user rhythm data.
User Tone Delete	—	—	Deletes selected user tone data.
Mixer Reset (InitMix?)	—	—	Initializes parameters assigned by the Mixer or by input from an external sequencer.
Parameter Reset (InitPar?)	—	—	Initializes all parameters, except for the display contrast setting.
System Reset (InitSys?)	—	—	Initializes the keyboard's parameters and registration data, and deletes all data stored in the keyboard's user area.



Using the SMF Player

The letters “SMF” stand for Standard MIDI File, which is a file format that allows MIDI data to be shared between different software and sequencers. There are actually three SMF formats, named SMF 0, SMF 1, and SMF 2. This keyboard supports the SMF 0 format, which is the one that is most widely used today, and so all mentions of “SMF data” in this manual refer to SMF 0 format data.

You can use your computer to transfer SMFs from the bundled CD-ROM to keyboard flash memory, or SMFs you have downloaded from the CASIO MUSIC SITE. SMF format music data can be stored in the keyboard’s built-in Flash memory. Data stored in Flash memory can be played back using the SMF Player Mode. You can also load SMF data from a SmartMedia card or floppy diskette into the keyboard’s user area and then play it back using the SMF Player Mode. The follow shows the maximum number of files that can be stored on each type of media.

Flash Memory: 200 files*

SmartMedia Card: 255 files*

Floppy Diskette (WK-3700 only): 112 (2DD diskette)* or 224 (2HD diskette) files*

* Note that the number of files you can store in memory also depends on the size of each file. If your files are very large, you may be able to store fewer than the number of files indicated above.

* Initially, your keyboard comes with three sample SMF tunes in memory.

IMPORTANT!

- Note that CASIO COMPUTER CO., LTD. shall not be held liable for any loss of data stored in Flash memory, or on a SmartMedia card or a floppy diskette (WK-3700 only).
-

SMF Player Mode Operational Flow

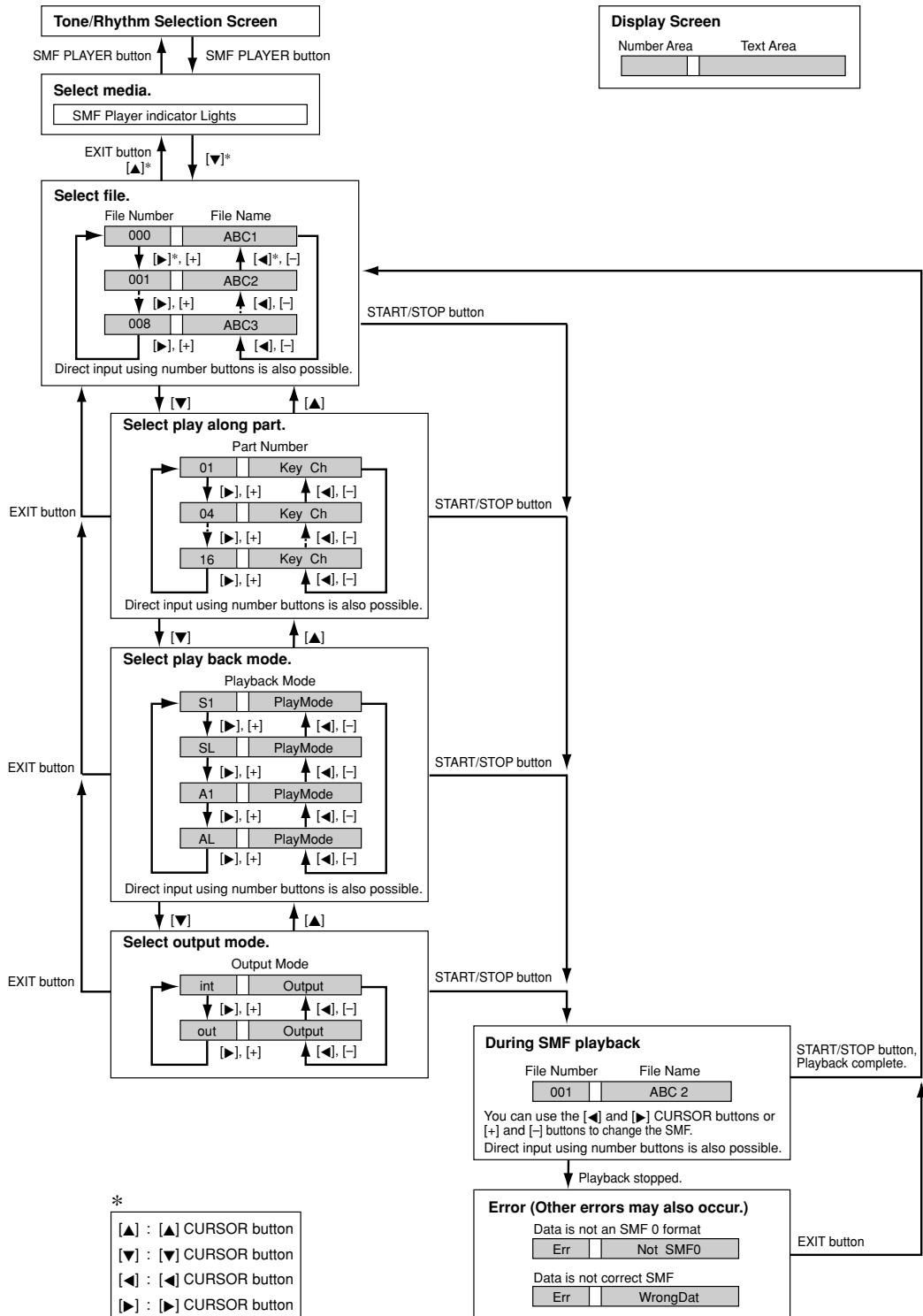

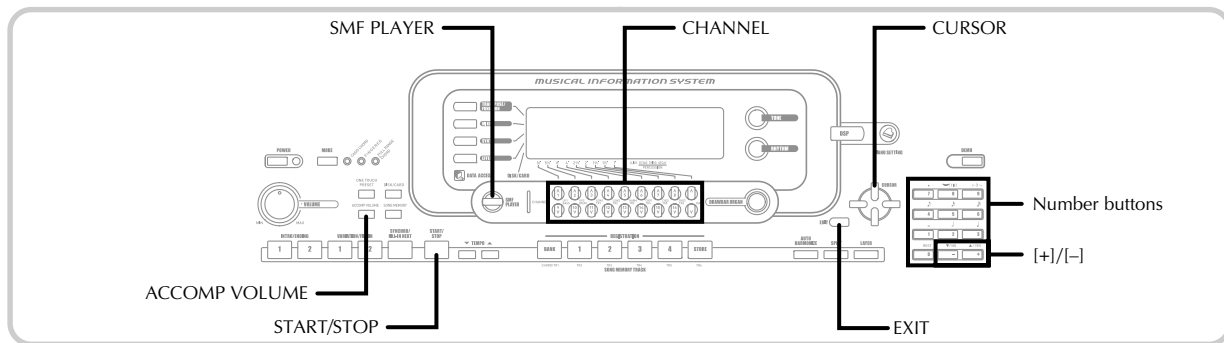

Playing Back an SMF

Note that the first step you need to perform in the procedure below depends on whether you are playing back from Flash memory, a SmartMedia card, or a floppy diskette (WK-3700 only).

PREPARATION

- SmartMedia Card
 - Insert the SmartMedia card that contains the data you want to play into the keyboard's card slot.
- Floppy Diskette (WK-3700 Only)
 - Insert the floppy diskette that contains the data you want to play into the keyboard's floppy disk drive.

IMPORTANT!

- Never remove the SmartMedia card from the card slot or turn off the keyboard while card data is being accessed by a save, read, or delete operation. Doing so can corrupt the data on the SmartMedia card or even damage the card slot.
- Before ejecting a diskette, always check to make sure that the access lamp is not lit or flashing. A lit or flashing access lamp means that the keyboard is performing a data read or write operation. Ejecting a diskette while it is being accessed can cause its data to become corrupted.

To play back an SMF

- 1 What you should do first depends on whether you are playing back from Flash memory, a memory card, or a floppy diskette.

Flash Memory

- 2-1 Use the SMF PLAYER button to display the "Internal" indicator in the text area of the screen.
 - This causes the "SMF PLAYER" indicator to appear on the display.

Internal

- After pressing the SMF PLAYER button, you can use the [◀] and [▶] CURSOR buttons to select the external storage media.

SmartMedia Card

- 2-2 Insert the SmartMedia card that contains the file you want to play into the keyboard's card slot. Use the SMF PLAYER button to display the "Card" indicator in the text area of the screen.
 - This causes the "SMF PLAYER" indicator to appear on the display.
 - After pressing the SMF PLAYER button, you can use the [◀] and [▶] CURSOR buttons to select the external storage media.

Floppy Diskette (WK-3700 only)

- 2-3 Insert the floppy diskette that contains the file you want to play into the keyboard's floppy disk drive. Use the SMF PLAYER button to display the "Disk" indicator in the text area of the screen.
 - This causes the "SMF PLAYER" indicator to appear on the display.
 - After pressing the SMF PLAYER button, you can use the [◀] and [▶] CURSOR buttons to select the external storage media.

- 3 Press the [▼] CURSOR button to display the file selection screen.
 - SMFs are those shows file names end with the extension "MID". An error message appears at this time if there are no SMF files currently in external storage media you are using.
- 4 Use the number buttons to input the three-digit file number of the file you want to play.
 - The name of the currently selected file will appear in the text area of the display. The file number is shown in the number area of the display. The Tempo/Measure area of the display shows the size of the file in kilobytes.
 - You can also use the [◀] and [▶] CURSOR buttons or [+] and [-] buttons to change the file.
- 5 Press the START/STOP button
 - This starts playback of the selected file.
 - You can use the TEMPO buttons to adjust the tempo within the range of 30 to 255.
 - You can use the CHANNEL buttons to turn channels 1 through 16 on and off, regardless of whether file playback is in progress or stopped. For more information, see "Turning Channels On and Off" on page E-40.
- 6 To stop file playback, press the START/STOP button again.

Adjusting SMF Playback Volume

The following procedure explains how to control the overall volume of SMF data playback. You can adjust volume while playback is stopped or ongoing.

- 1 Press the ACCOMP VOLUME button.
 - This causes the "SMF Vol." indicator to appear on the display, along with a value that indicates the current SMF volume setting.
- 2 Use the [+] and [-] buttons or the number buttons to adjust the SMF volume.
 - You can specify a setting in the range of 000 (minimum) to 127 (maximum).
 - Pressing [+] and [-] at the same time returns the SMF volume setting to 100.
 - Note that this setting does not affect the volume of the notes you play on the keyboard.

Configuring Other Settings

To configure other settings

- 1 While playback is stopped, select the file you want to play back.
 - Perform steps 1 through 3 under "To play back an SMF" to select a file.
- 2 Press the [▼] CURSOR button to display a screen for selecting the part you want to play on the keyboard (play along part).
 - Use the [◀] and [▶] CURSOR buttons, the [+] and [-] buttons, or the number buttons to select the play along part.
 - You can specify the part you want to play on the keyboard (the play-along part) as a value in the range of 1 through 16.
 - After specifying a part, turn off the channel that corresponds to the play-along part you selected. See "Turning Channels On and Off" on page E-40 for more information. Performing this step turns off the applicable part so you can play it on the keyboard along with the rest of the SMF playback.

NOTE

- Entering the SMF Player Mode initializes all parts by turning on all Mixer Mode channels.

- 3 Press the [▼] CURSOR button to display the playback mode selection screen. Use the [◀] and [▶] CURSOR buttons or the [+] and [-] buttons to select the playback mode.

You can select from among the following four playback modes.

S1 : One file, one time
 SL : One file, repeat
 A1 : All files, one time
 AL : All files, repeat

- 4 Press the [▼] CURSOR button to display the output mode selection screen.
 - Use the [◀] and [▶] CURSOR buttons or the [+] and [-] buttons to select the output mode.
 - You can select from among the following two output types.

int : Keyboard's built-in speakers
 out : MIDI OUT

NOTE

- Layer, split, and Auto Harmonize are automatically turned off in the SMF Player Mode.



SMF Player Error Messages

The following explains what you should do when an error message appears in the SMF Player Mode.

Error Message	Cause	Action
Err Not SMF0	You are attempting to play SMF data that is not Format 0.	Use only Format 0 SMF data.
Err WrongDat	There is a problem with the SMF data you are trying to play or the data is corrupted.	Use different data.

MIDI

What is MIDI?

What is MIDI?

MIDI is a standard for digital signals and connectors that allows musical instruments, computers, and other devices, regardless of manufacturer, to exchange data with each other.

MIDI Connections

To use a computer or other MIDI device to record and playback the MIDI data produced by this keyboard, you must connect the MIDI IN and MIDI OUT terminals of both devices in order to send and receive data.

[Rear Panel]

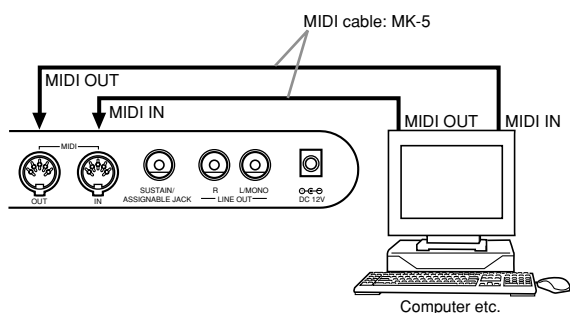

If a MIDI THRU function provided by the software is being run on a connected computer or other MIDI device, be sure to turn this keyboard's "Local Control Setting" off (page E-73).

General MIDI

This keyboard supports General MIDI, so it can be used to play commercially available pre-recorded General MIDI data and General MIDI data sent to it from a personal computer. See the "Tone List" on page A-1 for details about the tones that are available with GM tones numbered 000 to 127.

MIDI Settings

You can change the settings of a number of parameters that control how MIDI messages are sent and received.

MIDI Parameters

You can use the parameter setting procedure (page E-71) to change the settings of the MIDI parameters described below. See pages E-71 to E-73 for details about the setting menu and procedure.

■ MIDI In Chord Judge

This parameter determines whether note data received from an external device should be interpreted as an auto accompaniment chord fingering. Turn on this parameter when you want to control auto accompaniment chords from a computer or other external device.

on: Causes note data input through MIDI IN to be interpreted as auto accompaniment chord fingerings. The channel specified by the keyboard channel is used for specifying chords.

oFF: Turns off "MIDI In Chord Judge".

■ Accomp/Song MIDI Out (Accompaniment/Song MIDI Out)

Turn on this parameter when you want sound auto accompaniment or Song Memory on an external device's sound source.

on: Outputs auto accompaniment or Song Memory as MIDI messages through the keyboard's MIDI OUT terminal.

oFF: Does not output auto accompaniment or Song Memory.

NOTE

- For details about MIDI specifications, visit the CASIO Website.
<http://world.casio.com>

Using the Music Data Management Software (on the Bundled CD-ROM)

The Music Data Management Software application on the CD-ROM that comes bundled with the keyboard lets you transfer data you downloaded from the CASIO MUSIC SITE from your computer to keyboard memory. You can also use it to save keyboard data to your computer's hard disk. Music Data Management Software supports transfer of the following type of data.

- SMF
- Rhythm Patterns
- Registrations
- User songs created in the Song Memory Mode
- Drum sounds with waveform
- Drawbar organ tones
- Tone
- Tones with waveforms
- DSP
- Package file
- All user data

CASIO MUSIC SITE

<http://music.casio.com/>

Music Data Management Software

Music Data Management Software makes it possible for your computer to transfer data you downloaded from the CASIO Music Site to keyboard memory, and to transfer keyboard memory data to your computer's hard disk for storage. After starting up the Music Data Management Software, you can access the following three converter applications.

■ Wave Converter

Wave Converter creates keyboard Tone With Wave data from tone data files (.wav) stored on your computer's hard disk.

■ Rhythm Converter

Rhythm Converter creates keyboard Rhythm data from SMF format rhythm data stored on your computer's hard disk.

■ Parameter Editor

Parameter Editor makes it possible to use your computer to edit keyboard parameters.

■ To install the Music Data Management Software

• Before installing the Music Data Management Software, be sure to read the contents of the applicable readme.txt file. You can find the readme.txt file inside the same language folder where the Music Data Management Software you are installing is located.

1. To install the Music Data Management Software, navigate to the CD-ROM on your computer and double-click "wk3-30.exe". Next, follow the instructions that appear on your computer screen.

* An English-language manual with detailed explanations about Music Data Management Software operations is located in the English folder on the CD-ROM. You can access the manual by opening its HTML named "index.html" using one of the following types of web browser applications. Other language versions of this manual are available for free download from the CASIO MUSIC SITE.

Internet Explorer 4 or higher
Netscape Navigator 4.04 or higher

* Supported Computer Operating Systems
The Music Data Management Software will run under the following operating systems.

Windows 98SE
Windows Me
Windows 2000
Windows XP

IMPORTANT!

- Though Music Data Management Software is designed to run under the standard configurations of the above operating systems, note that it may not be able to run correctly under certain software and hardware environments.
- Music Data Management Software does not support operation on a Macintosh.

Downloading Data

Visit the CASIO MUSIC SITE for information about downloading data.

When you arrive at the CASIO MUSIC SITE, select a geographic area or country. Next, select an Internet Data Expansion System data download service.

Note that the services that are available at the CASIO MUSIC SITE depend on the area or country you select.

Bundled CD-ROM Data

The CD-ROM that comes bundled with the keyboard has a folder named "Data", which contains various data folders. For details about the data contained in the data folders, see the "list.txt" file inside of each folder.

■ Retuning the keyboard to its initial factory defaults

The "Data" folder on the CD-ROM that comes bundled with the keyboard includes a file named "alldata.ckf", which contains factory default setup data. Transferring the "alldata.ckf" data to the keyboard's flash memory will return all settings to their initial factory defaults.

- For information about transferring data to the keyboard's flash memory, see the application software manual.

To connect to a computer

Be sure to turn off the keyboard and your computer before connecting them. You should also set the volume controller of the keyboard to a relatively low volume.

- 1 Connect the keyboard's MIDI interface to your computer's MIDI interface.

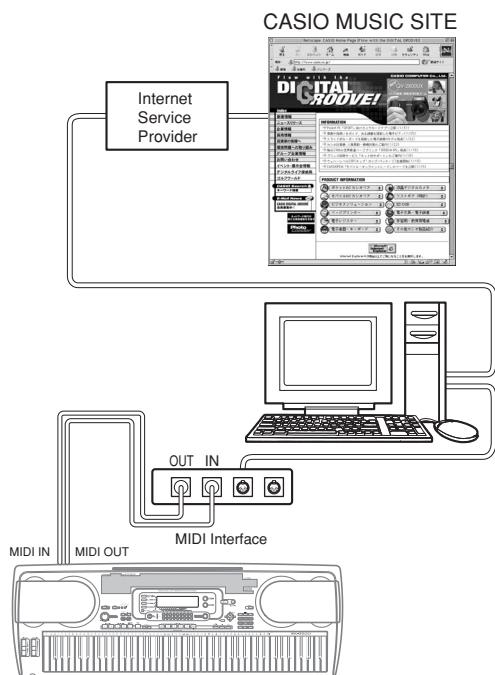

- 2 Turn on the keyboard, and then turn on your computer or other connected device.
- 3 Start up the software you want to use on your computer.

NOTE

- When using the application software, make sure that the tone setting screen (the screen that appears after turning on power) is on the keyboard's display screen.
- Performing a keyboard operation while transferring data between it and a computer may interrupt the data transfer. Do not perform any keyboard operations while data transfer is in progress

DATA ACCESS Lamp

- The DATA ACCESS lamp lights whenever the keyboard is exchanging data with a connected computer over a MIDI cable connection. Never disconnect the MIDI cable while the DATA ACCESS lamp is lit.

Saving Data

You can save data you create and data you transfer to the keyboard from a computer to the keyboard's built-in Flash memory, or to a SmartMedia card™ or floppy diskette (WK-3700). In this manual, SmartMedia cards and floppy diskettes are referred to as "external storage media".

The types of files that can be saved to external storage media are listed below. Note that each type of file can be saved to a specific, pre-defined user area, as shown in the "Savable File Types" table below.

After you load SMF data from external storage media and store it in a user area, you can play it back using the SMF Player Mode. See "Using the SMF Player" on page E-74 for more information.

Savable File Types

Type	Display Indicator	Saved Data	User Area Number	User Memory Capacity	File Name Extension
SMF	Smf	1 Tune	000 – 199	200	MID
Rhythm Pattern	Pattern	1 Pattern	160 – 175	16	Z00
Registration	Regist	1 Bank	1 – 8	8	Z01
User song created in the Song Memory Mode	Song	1 Tune	0 – 4	5	Z02
Drum sound with waves	Dr wave	1 Set	900 – 903	4	Z03
Drawbar organ tone	Drawbar	1 Tone	100 – 199	100	Z04
Tone	Tone	1 Tone	700 – 799	100	Z05
Tone with waves	Tn wave	1 Tone	800 – 819	20	Z06
DSP	Dsp	1 Type	100 – 199	100	Z07
Package File*1	Package	1 Pack	—	1	Z08
All User Data*2	All Data	1 Set	—	1	Z09

*1: Package File

A package file combines tone settings, DSP effect settings, and other setup data into a single file that you can manage and load as a unit (package). Once you create a package file, you will be able to change the entire setup of the keyboard by loading a single package file. To create a package file, you need to download special package file software from the CASIO Music Site (<http://music.casio.com/>) and install it on your computer. For details about the package file software, see the information provided at the CASIO Music Site.

*2: All of the user data (SMF to package file) in the above table can be handled as a single file. Note, however, that due to the size of the file, it cannot be stored on a floppy diskette.

Package File Data Contents

Data Type	User Area
SMF	190 to 199 (10 Songs)
Rhythm Patterns	168 to 175 (8 rhythms)
Registrations	7 to 8 (2 banks)
Drum Sound With Waves	903 (1 set)
Drawbar Organ Tones	190 to 199 (10 tones)
Tones	790 to 799 (10 tones)
Tones With Waves	810 to 819 (10 tones)
DSP	190 to 199 (10 effects)

IMPORTANT!

- Loading a package file loads the setting data listed in the table under "Package File Data Contents" into the user area, and replaces all current data with the data in the package file.
- When loading a package file or All Data from or writing such data to a SmartMedia card or floppy diskette (WK-3700 only), the display's level meter shows the progress of the load/write operation as shown below.

[Start]

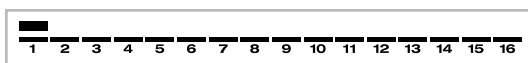

[End]



Using a SmartMedia Card

Your keyboard is equipped with a card slot that supports the use of SmartMedia™ cards that you can use to store tunes you transfer from your computer, song memory data you have stored in the keyboard's flash memory, and other data. This provides you with access to virtually unlimited volumes of data that you can instantly load whenever you need it.

IMPORTANT!

- There are two types of SmartMedia cards: 3.3V and 5V. Note that this keyboard supports use of 3.3V type SmartMedia cards only.
- Never try to use a 5V type SmartMedia card with this keyboard.
- Note you will not be able to store data to, delete data from, or rename a SmartMedia card that has a write protect sticker affixed to the card's write protect area.

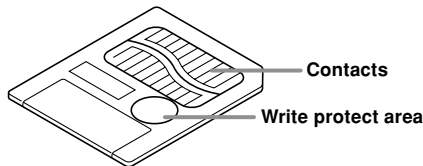

About SmartMedia™ Cards

- You can purchase SmartMedia cards at most household appliance stores, computer stores, etc.
- SmartMedia cards are commercially available in capacities ranging from 8MB up to 128MB.
- Though a SmartMedia card is about the size of a postage stamp, its capacity ranges from 8 to 100 times the capacity of a floppy diskette.
- The data read rate from a SmartMedia card is very fast.
- SmartMedia™ is a trademark of Toshiba Corporation.

SmartMedia Card and Card Slot Precautions

IMPORTANT!

- Be sure to carefully read all documentation that comes with the SmartMedia card for important information about how to handle it.
- Avoid storing and using SmartMedia cards in the following types of locations. Such conditions can cause corruption of data stored on the card.
 - Areas subject to high temperatures, high humidity, or corrosive agents
 - Areas subject to strong electrostatic charge or electrical noise
- Whenever handling a SmartMedia card, make sure that you never touch its contacts with your fingers.
- If the data access lamp is lit and the message "Pls Wait" is on the display, it means that data on the SmartMedia card is being accessed by a save, read, or delete operation. Never remove the SmartMedia card from the card slot or turn off the keyboard while the card is being accessed. Doing so can corrupt the data on the SmartMedia card or even damage the card slot.
- Never try to insert any type of card other than a 3.3V SmartMedia card into the card slot. Doing so can damage the keyboard.
- Inserting a SmartMedia card that is charged with static electricity into the card slot can cause malfunction of the keyboard. If this happens, turn the keyboard off and then back on again.
- A SmartMedia card that has been in the card slot for a long time may feel hot when you remove it. This is normal and does not indicate malfunction.
- Note that a SmartMedia card has a limited service life. After long use, you may not be able to store data to, read data from, and/or delete data from a card. When this happens, you will need to purchase a new SmartMedia card.

CASIO COMPUTER CO., LTD. assumes no responsibility for any loss or damage to you or any third party arising out of the loss or corruption of data.

Using a Card with the Keyboard

When using a card with the keyboard, first be sure to format the card on the keyboard. See "Formatting External Storage Media" on page E-91 for details about formatting

Inserting and Removing a SmartMedia Card

The following describes how to insert a SmartMedia card into the card slot and how to remove it.

To insert a SmartMedia card into the card slot

With the contact side of the SmartMedia card facing downwards, insert the card into the card slot. Carefully push the card into the slot as far as it will go.

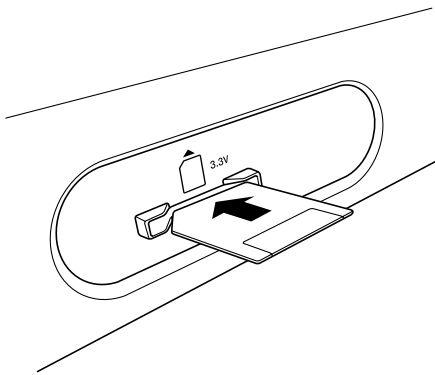

To remove a SmartMedia card from the slot

After making sure that the data access lamp is not lit and the message "Pls Wait" is not on the display, carefully pull the card from the slot.*

* Never remove the SmartMedia card from the card slot or turn off the keyboard card while any of the following conditions exists.

- While the keyboard is in the SMF Player Mode and there is a pointer next to CARD on the display
- While the data access lamp is lit and the message "Pls Wait" is on the display, indicating that a card access operation is being performed

IMPORTANT!

- Never remove the SmartMedia card from the card slot or turn off the keyboard while card data is being accessed by a save, read, or delete operation. Doing so can corrupt the data on the SmartMedia card or even damage the card slot.

Using the Floppy Disk Drive (WK-3700 Only)

Floppy Disk Drive Features

The WK-3700 comes with a built-in disk drive, which provides you with the capabilities described below.

- You can save song memory and synthesizer data on a floppy diskette for long-term storage. When you need the data again, simply insert the diskette into the disk drive and load it.
- You can play back SMF (standard MIDI file) data created on a personal computer and saved to diskette.

Floppy Diskette Precautions

IMPORTANT!

- Avoid the following locations when storing and using diskettes. Any of the conditions noted below can cause data stored on the diskette to become corrupted.
 - Near TVs, on top of audio equipment, or in any area exposed to magnetism. Take special care to keep diskettes away from any source of magnetism.
 - Areas exposed to direct sunlight, or subject to high humidity or temperature extremes.
- Failure to observe any of the following precautions can cause data stored on the diskette to become corrupted.
 - Never try to take a diskette apart.
 - Never open the shutter of the diskette or touch the film inside with your fingers.
 - Never bend a diskette or otherwise subject it to rough handling.
 - Affix labels in the spaces provided only, and do not affix labels on top of previous ones.

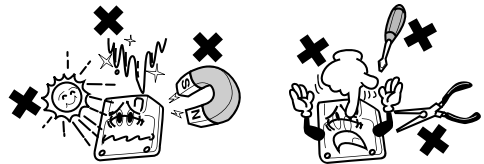

- Do not eject the diskette from the drive while the access lamp is lit or flashing or turn off keyboard power with a diskette in the drive. Doing either can cause data on the diskette to become corrupted and can even cause malfunction of the disk drive.
- Never insert any foreign objects into the disk drive. Doing so can cause it to malfunction.
- The disk drive uses a magnetic head. A dirty head cannot read data from a diskette properly and can corrupt existing data on the diskette. To avoid this, be sure to use a commercially available head cleaning diskette to periodically clean the head.

- Do not use a computer, another electronic musical instrument, or any other device to change a file name or file contents created with this keyboard. Doing so can make the data unusable by this keyboard and even cause malfunction of the keyboard.

Note that CASIO COMPUTER CO., LTD. shall not be held liable for any loss to you or any third party due to corruption or accidental erasure of data on a diskette.

About Floppy Diskettes

This section contains important information about handling diskettes. Be sure to read it before going any further.

Diskette Types

The WK-3700 supports use of both 3.5' 2HD (1.44MB formatted) and 2DD (720KB formatted) diskettes. Use of other disk sizes and capacities is not supported.

Diskette Type Indicators

2HD A 2HD diskette is marked with the letters "HD" in the upper right corner of the front side. Also, there is a square hole in the lower right corner.

2DD This type of diskette does not have a hole in the lower right corner.

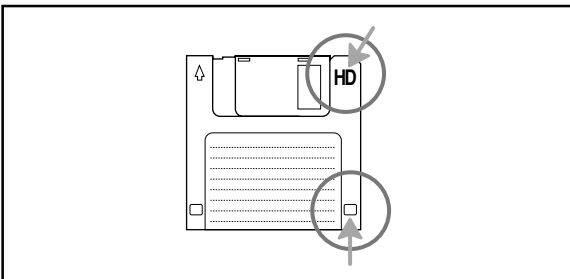

Write Protection

IMPORTANT!

- You can write protect a diskette so data on it cannot be deleted and no new data can be stored on the diskette. Also, a write protected diskette cannot be formatted. You can read data from a diskette regardless of whether or not it is write protected.

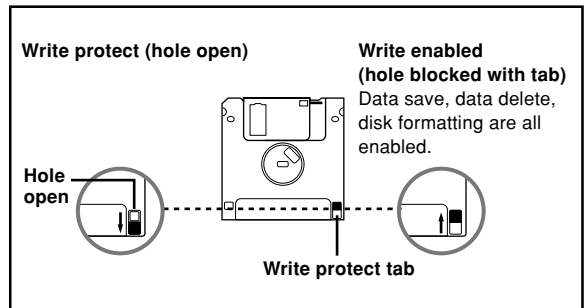

- When the write protect hole is open as shown in the illustration, you can read the contents of the diskette, but you cannot write data to or delete data from the diskette. After saving important data to a diskette, be sure to open its write protect hole to protect the data against accidental changes or deletion.
- The diskette that comes with the keyboard contains sample data. It is write protected to avoid accidental erasure or formatting. Make sure you handle this diskette carefully to avoid damaging or erasing its data.

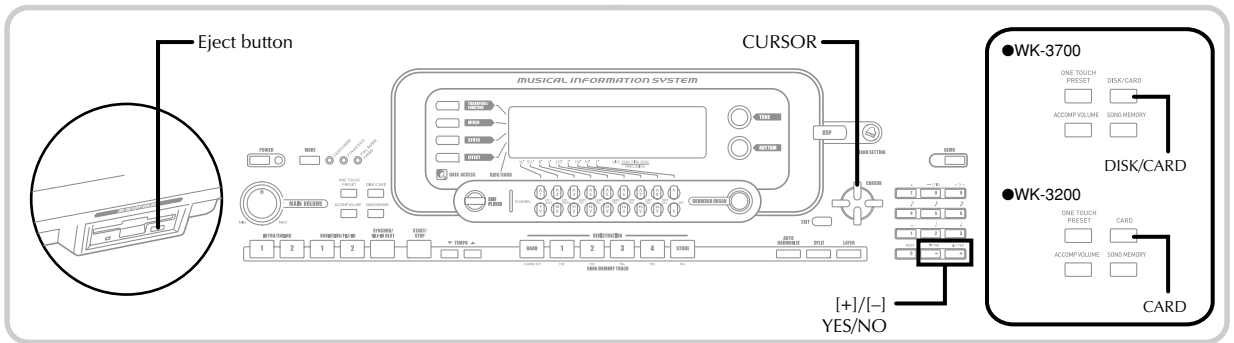

Inserting and Ejecting a Diskette

The following describes how to insert a diskette into the disk drive and how to eject it.

To insert a diskette into the floppy disk drive

- 1 With the label area of the diskette facing up, insert the diskette shutter first into the disk drive, as shown in the illustration.

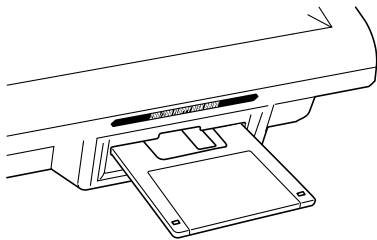

- 2 Slide the diskette into the drive as far as it will go, until it clicks into place.

To eject a diskette from the floppy disk drive

IMPORTANT!

- Before ejecting a diskette, always check to make sure that the access lamp is not lit or flashing. A lit or flashing access lamp means that the keyboard is performing a data read or write operation. Ejecting a diskette while it is being accessed can cause its data to become corrupted.

- 1 Press the Eject button.
 - This causes the diskette to be partially ejected from the disk drive.
- 2 Remove the diskette from the drive by hand.

Using External Storage Media

This section explains how to use SmartMedia cards and floppy diskettes (WK-3700 only) for data storage. In this manual, SmartMedia cards and floppy diskettes are collectively referred to as “external storage media”.

NOTE

- Layer, split, and Auto Harmonize are automatically turned off while external storage is being used. Tone and rhythm selection, and rhythm playback are also all disabled.

Basic SmartMedia Card Operation

- 1 Insert the SmartMedia card into the card slot.
- 2 Enter the Card Mode.
 - * WK-3700
Press the DISK/CARD button twice.
 - This causes a pointer to appear next to the DISK/CARD on the display, and also displays “Card” in the display’s text area.
 - * WK-3200
Press the CARD button.
 - This causes a pointer to appear next to the CARD on the display, and also displays “Card” in the display’s text area.

NOTE

- After pressing the DISK/CARD button (WK-3200: CARD button) once, you can use the [◀] and [▶] CURSOR buttons to select the external storage media.

- 3 Press the [▼] CURSOR button to display the Card Mode menu.

- 4 Use the [◀] and [▶] CURSOR buttons to display the screen for the type of operation you want to perform.

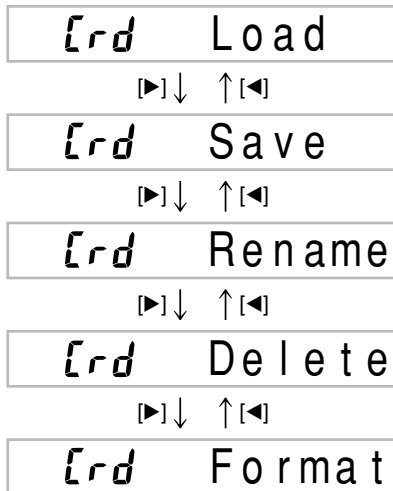

- See the pages referenced below for details about using each of the above menu operations.

Loading a file (Crd Load):	page E-88
Saving a file (Crd Save):	page E-87
Renaming a file (Crd Rename):	page E-90
Deleting a file (Crd Delete):	page E-90
Formatting a SmartMedia card (Crd Format):	page E-91

- 5 Press the [▼] CURSOR button to advance to the next operation screen of each menu.

Basic Floppy Diskette Operation (WK-3700 Only)

- 1 Insert a floppy diskette into the keyboard's floppy disk drive.
- 2 Press the DISK/CARD button.
 - This causes a pointer to appear next to the DISK/CARD on the display, and also displays "Disk" in the display's text area.
- 3 Perform the same operations as those starting from step 3 of under "Basic SmartMedia Card Operation" on page E-86.
 - Note that Disk Mode operations are indicated on the display by the prefix "Fd" in place of the "Crd" prefix of the Card Mode operations.

Saving Files

You can use the procedures in this section to save Song Memory, Synthesizer, and other data you create to external storage media for later loading when you need it. See "Savable File Types" on page E-82 for information about the type of data you can save.

PREPARATION

- SmartMedia Card
 - Insert the SmartMedia card that has been formatted on the keyboard into the keyboard's card slot. Make sure that the sticker is removed from the card's write area, which enables writing.
- Floppy Diskette (WK-3700 Only)
 - Insert a properly formatted floppy diskette into the keyboard's floppy disk drive. Make sure that the diskette's write protect hole is closed, which enables writing.

NOTE

- Depending on the type and the amount of data involved, a SmartMedia card or floppy diskette (WK-3700 only) data save or load operation can take anywhere from a few minutes to more than 10 minutes to complete. The message "Pls Wait" will remain on the display to indicate that a data save or load operation is being performed.

IMPORTANT!

- Never try to perform any operation while "Pls Wait" is displayed. Performing any operation can cause Flash memory or SmartMedia card or floppy diskette data to be deleted, and damage the keyboard's memory and cause it to malfunction.

To save a file to external storage media

- 1 What you should do first depends on the type of external storage media you are using.
 - SmartMedia Card:
 - On the WK-3200 press the DISK/CARD button twice. On the WK-3200, press the CARD button once.
 - This causes a pointer to appear next to the DISK/CARD or CARD on the display, and also displays "Card" in the display's text area.
 - Floppy Diskette (WK-3700 Only):
 - Press the DISK/CARD button.
 - This causes a pointer to appear next to the DISK/CARD on the display, and also displays "Disk" in the display's text area.

NOTE

- After pressing the DISK/CARD button (WK-3200: CARD button) once, you can use the [◀] and [▶] CURSOR buttons to select the external storage media.

- 2 Press the [▼] CURSOR button to display the Card Mode (or Disk Mode) menu.
- 3 Use the [◀] and [▶] CURSOR buttons to display the "Save" screen.
- 4 Press the [▼] CURSOR button to advance to the file type selection screen.
- 5 Use the [◀] and [▶] CURSOR buttons to select the file type.
- 6 Press the [▼] CURSOR button to advance to the user area selection screen.
- 7 Use the [◀] and [▶] CURSOR buttons or [+] and [-] buttons to select the user area where the file you want to save is located.
 - The numeric area of the display will show the user area number, while the text area will show the user area name*.
 - * Except registrations and user songs
 - Pressing the EXIT or [▲] CURSOR button at this time will return you to the file type selection screen.
 - The user area selection screen will not appear if the file you selected is a package file or "All Data" file. In this case, skip this step and go directly to screen.
- 8 Press the [▼] CURSOR button to advance to the file name input screen.

Initial file name displayed on the screen

Rhythm Patterns	U_PTRN00
Registrations	U_RGST00
User Songs Created in the Song Memory Mode	U_SONG00
Drum Sounds with Waveform	U_DRUM00
Drawbar Organ Tones	U_ORGN00
Tones	U_TONE00
Tones with Waveforms	U_TONW00
DSP	U_EFCT00
Package File	PACKAGE00
All User Data	ALLDATA00

- The initial default file name of the SMF will be the same as the name of the user area you selected in step 7.
- Use the [+] and [-] buttons to scroll through letters at the current cursor location. See the page E-92 for information about inputting text.
- Use the [◀] and [▶] CURSOR buttons to move the cursor left and right.

- 9 After inputting the file name, press the [▼] CURSOR button.
 - If you are saving song data, the file type selection screen appears next. Use the [◀] and [▶] CURSOR buttons to select "SMF" or "SONG". After selecting a file type, press the [▼] CURSOR button.
 - This will display a confirmation message asking whether you really want to save the data. If the media already contains a file with the same name, a confirmation message appears asking if you want to overwrite the existing file with a new one.
- 10 Press the YES button to save the data. This will cause the message "Pls Wait" to appear on the display to indicate that a card access operation is being performed. Never try to perform any other operation on the keyboard while the card is being accessed. The message "Complete" will appear on the display after data save is complete. After a few seconds, the message will be replaced by the file name selection screen.
 - If you do not want to continue with data save, press the EXIT button or the NO button in response to the above confirmation message. This will return you to the user area selection screen in step 7.
- 11 After you are finished performing the save operation, press the DISK/CARD button (CARD button on the WK-3200) to exit the Card Mode.

Loading a File

Use the procedures in this section when you want to load data from external storage media into the keyboard's user area.

IMPORTANT!

- Note the following important points whenever using the SMF Player Mode to play back data saved with the above procedure.

* SmartMedia Card

To perform the procedure below, you must have a SmartMedia card to which SMF data has been copied from a computer. Insert a SmartMedia card that you have formatted on the keyboard into the card slot of your computer, and copy the SMF data you want to load into the directory named "CASIO_MD". Note that you will not be able to load the data if it is not located inside the "CASIO_MD" directory. If you create a sub-directory inside of the "CASIO_MD" directory, the keyboard will not be able to load any data inside the sub-directory.

* Floppy Diskette (WK-3700 only)

This keyboard is able to see only files that are in the top (root) directory of the floppy diskette. It will not be able to see any files that are located in a subdirectory.

PREPARATION

- SmartMedia Card
 - Insert the SmartMedia card that contains the data you want to load into the keyboard's card slot.
- Floppy Diskette (WK-3700 Only)
 - Insert the floppy diskette that contains the data you want to load into the keyboard's floppy disk drive.

NOTE

- Depending on the type and the amount of data involved, a SmartMedia card or floppy diskette (WK-3700 only) data save or load operation can take anywhere from a few minutes to more than 10 minutes to complete. The message "Pls Wait" will remain on the display to indicate that a data save or load operation is being performed.

IMPORTANT!

- Never try to perform any operation while "Pls Wait" is displayed. Performing any operation can cause Flash memory or SmartMedia card or floppy diskette data to be deleted, and damage the keyboard's memory and cause it to malfunction.

To recall file data from external storage media

- 1 What you should do first depends on the type of external storage media you are using.
 - SmartMedia Card
 - On the WK-3700 press the DISK/CARD button twice. On the WK-3200, press the CARD button once.
 - This causes a pointer to appear next to the DISK/CARD or CARD on the display, and also displays "Card" in the display's text area.
 - Floppy Diskette (WK-3700 Only)
 - Press the DISK/CARD button.
 - This causes a pointer to appear next to the DISK/CARD on the display, and also displays "Disk" in the display's text area.

NOTE

- After pressing the DISK/CARD button (WK-3200: CARD button) once, you can use the [◀] and [▶] CURSOR buttons to select the external storage media.

- 2 Press the [▼] CURSOR button to display the Card Mode (or Disk Mode) menu.
- 3 Use the [◀] and [▶] CURSOR buttons to display the "Load" screen.
- 4 Press the [▼] CURSOR button to advance to the file type selection screen.

- 5 Use the [◀] and [▶] CURSOR buttons to select the type file you want to load.
- 6 Press the [▼] CURSOR button to display the file name selection screen.
- 7 Use the [◀] and [▶] CURSOR buttons or [+] and [-] buttons to select the name of the file you want to load.
 - You could also use the number buttons to input a three-digit file number. The file number is shown in the number area of the display.
- 8 Press the [▼] CURSOR button to advance to the user area selection screen.
- 9 Use the [◀] and [▶] CURSOR buttons or [+] and [-] buttons to select the user area to which you want to import the loaded file data.
 - The numeric area of the display will show the user area number, while the text area will show the user area name*.
 - * Except registrations and user songs
 - The user area selection screen will not appear if the file you selected is a package file or "All Data" file. In this case, skip step 9 and go directly to step 10.
 - Pressing the EXIT or [▲] CURSOR button at this time will return you to the file type selection screen.
- 10 After selecting the user area, press the [▼] CURSOR button.
 - This will display a confirmation message asking whether you really want to load the data. If you already have data in the user area, the message will ask if you want to overwrite the existing data with the loaded data.
- 11 Press the YES button to recall the data.
 - This will cause the message "Pls Wait" to appear on the display to indicate that a card access operation is being performed. Never try to perform any other operation on the keyboard while the card is being accessed. The message "Complete" will appear on the display after data loading is complete. After a few seconds, the message will be replaced by the file name selection screen.
 - If you do not want to continue with data loading, press the EXIT button or the NO button in response to the above confirmation message. This will return you to the user area selection screen in step 9.
- 12 After you are finished performing the load operation, press the DISK/CARD button (CARD button on the WK-3200) to exit the Card Mode.

Renaming a File

You can use the procedures in this section to change the name of a file that you previously saved to external storage media.

PREPARATION

- SmartMedia Card
 - Insert the SmartMedia card that contains the file you want to rename into the keyboard's card slot. Make sure that the sticker is removed from the card's write area, which enables writing.
 - Floppy Diskette (WK-3700 Only)
 - Insert the floppy diskette that contains the file you want to rename into the keyboard's floppy disk drive. Make sure that the diskette's write protect hole is closed, which enables writing.
-

To rename a file saved to external storage media

- 1 What you should do first depends on the type of external storage media you are using.
 - SmartMedia Card
 - On the WK-3700 press the DISK/CARD button twice. On the WK-3200, press the CARD button once.
 - This causes a pointer to appear next to the DISK/CARD or CARD on the display, and also displays "Card" in the display's text area.
 - Floppy Diskette (WK-3700 Only)
 - Press the DISK/CARD button.
 - This causes a pointer to appear next to the DISK/CARD on the display, and also displays "Disk" in the display's text area.

NOTE

- After pressing the DISK/CARD button (WK-3200: CARD button) once, you can use the [◀] and [▶] CURSOR buttons to select the external storage media.
-

- 2 Press the [▼] CURSOR button to display the Card Mode (or Disk Mode) menu.
- 3 Use the [◀] and [▶] CURSOR buttons to display the "Rename" screen.
- 4 Press the [▼] CURSOR button to advance to the file type selection screen.
- 5 Use the [◀] and [▶] CURSOR buttons to select the type of the file you want to rename.

- 6 Press the [▼] CURSOR button to display the file name selection screen.
- 7 Use the [◀] and [▶] CURSOR buttons or [+] and [-] buttons to select the name of the file you want to rename.
 - You could also use the number buttons to input a three-digit file number. The file number is shown in the number area of the display.
- 8 Press the [▼] CURSOR button to advance to the file name input screen.
 - Use the [+] and [-] buttons to scroll through letters at the current cursor location. See the page E-92 for information about inputting text.
 - Use the [◀] and [▶] CURSOR buttons to move the cursor left and right.
- 9 After inputting the file name, press the [▼] CURSOR button.
 - This will display a confirmation message asking whether you really want to change the name.
- 10 Press the YES button to change the file name.
 - This will cause the message "Pls Wait" to appear on the display to indicate that a card access operation is being performed. Never try to perform any other operation on the keyboard while the card is being accessed. The message "Complete" will appear on the display after renaming is complete. After a few seconds, the message will be replaced by the file name selection screen.
 - If you do not want to continue with file renaming, press the EXIT button or the NO button in response to the above confirmation message. This will return you to the file selection screen.
- 11 After you are finished performing the rename operation, press the DISK/CARD button (CARD button on the WK-3200) to exit the Card Mode.

Deleting a File

You can perform the procedure in this section to delete a file from external storage media.

IMPORTANT!

- Note that the file delete operation cannot be undone. Make sure that you no longer need data before you delete it.
 - Deleting a file causes all of the file numbers following it to be reduced by one. If you plan to delete another file, make sure that you do not specify the wrong file number.
-

PREPARATION

- SmartMedia Card
 - Insert the SmartMedia card that contains the file you want to delete into the keyboard's card slot. Make sure that the sticker is removed from the card's write area, which enables writing.
- Floppy Diskette (WK-3700 Only)
 - Insert the floppy diskette that contains the file you want to delete into the keyboard's floppy disk drive. Make sure that the diskette's write protect hole is closed, which enables writing.

To delete a file from external storage media

- 1 What you should do first depends on the type of external storage media you are using.
 - SmartMedia Card
 - On the WK-3700 press the DISK/CARD button twice. On the WK-3200, press the CARD button once.
 - This causes a pointer to appear next to the DISK/CARD or CARD on the display, and also displays "Card" in the display's text area.
 - Floppy Diskette (WK-3700 Only)
 - Press the DISK/CARD button.
 - This causes a pointer to appear next to the DISK/CARD on the display, and also displays "Disk" in the display's text area.

NOTE

- After pressing the DISK/CARD button (WK-3200: CARD button) once, you can use the [◀] and [▶] CURSOR buttons to select the external storage media.

- 2 Press the [▼] CURSOR button to display the Card Mode (or Disk Mode) menu.
- 3 Use the [◀] and [▶] CURSOR buttons to display the "Delete" screen.
- 4 Press the [▼] CURSOR button to advance to the file type selection screen.
- 5 Use the [◀] and [▶] CURSOR buttons to select the type of the file you want to delete.
- 6 Press the [▼] CURSOR button to display the file name selection screen.

- 7 Use the [◀] and [▶] CURSOR buttons or [+] and [-] buttons to select the name of the file you want to delete.
 - You could also use the number buttons to input a three-digit file number. The file number is shown in the number area of the display.
- 8 After selecting the file, press the [▼] CURSOR button.
 - This will display a confirmation message asking whether you really want to delete the file.
- 9 Press the YES button to delete the file.
 - This will cause the message "Pls Wait" to appear on the display to indicate that a card access operation is being performed. Never try to perform any other operation on the keyboard while the card is being accessed. The message "Complete" will appear on the display after file deletion is complete. After a few seconds, the message will be replaced by the file name selection screen.
 - If you do not want to continue with file deletion, press the EXIT button or the NO button in response to the above confirmation message. This will return you to the file name selection screen.
- 10 After you are finished performing the delete operation, press the DISK/CARD button (CARD button on the WK-3200) to exit the Card Mode.

Formatting External Storage Media

Use the procedures in this section to format external storage media before using it for the first time, or when you want to delete all of the contents on a SmartMedia card or floppy diskette.

IMPORTANT!

- Note that formatting a card or diskette that already contains data causes all of that data to be deleted. Data deleted by the format operation cannot be recovered. Before performing the procedure below, check to make sure that the media does not contain any data you might need.

PREPARATION

- SmartMedia Card
 - Insert the SmartMedia card you want to format into the keyboard's card slot. Make sure that the sticker is removed from the card's write area, which enables writing.
- Floppy Diskette (WK-3700 Only)
 - Insert the floppy diskette you want to format into the keyboard's floppy disk drive. Make sure that the diskette's write protect hole is closed, which enables writing.

To format external storage media

- What you should do first depends on the type of storage media you are using.

 - SmartMedia Card
On the WK-3700 press the DISK/CARD button twice. On the WK-3200, press the CARD button once.
 - This causes a pointer to appear next to the DISK/CARD or CARD on the display, and also displays "Card" in the display's text area.
- Floppy Diskette (WK-3700 Only)
Press the DISK/CARD button.
 - This causes a pointer to appear next to the DISK/CARD on the display, and also displays "Disk" in the display's text area.

NOTE

- After pressing the DISK/CARD button (WK-3200: CARD button) once, you can use the [◀] and [▶] CURSOR buttons to select the external storage media.

- Press the [▼] CURSOR button to display the Card Mode (or Disk Mode) menu.
- Use the [◀] and [▶] CURSOR buttons to display the "Format" screen.
- Press the [▼] CURSOR button.
 - WK-3700 Users
If you are formatting a floppy diskette, a screen will appear here for specification of the floppy diskette density. Use the [◀] and [▶] CURSOR buttons to select either "2DD" or "2HD", and then press the [▼] CURSOR button.
 - This will display a confirmation message asking whether you really want to format the media.
- Press the YES button to start formatting.
 - This will cause the message "Pls Wait" to appear on the display to indicate that a card access operation is being performed. Never try to perform any other operation on the keyboard while the card is being accessed. The message "Complete" will appear on the display after media formatting is complete. After a few seconds, the message will be replaced by the screen for the type of operation.
 - If you do not want to continue with formatting, press the EXIT button or the NO button in response to the above confirmation message. This will return you to the screen for the type of operation.
- After you are finished performing the format operation, press the DISK/CARD button (CARD button on the WK-3200) to exit the Card Mode.

Inputting Characters

The following describes the types of characters you can input when saving data to the user area and external storage media.

User Area Data

!	"	#	\$	%	&	'	()	
*	+	,	-	.	/	0	1	2	3
4	5	6	7	8	9	:	;	<	=
>	?	@	A	B	C	D	E	F	G
H	I	J	K	L	M	N	O	P	Q
R	S	T	U	V	W	X	Y	Z	[
¥]	^	_	`	a	b	c	d	e
f	g	h	i	j	k	l	m	n	o
p	q	r	s	t	u	v	w	x	y
z	{		}						

External Storage Media Data

You can input the same characters as those that are allowed for MS-DOS file names.

0	1	2	3	4	5	6	7	8	9
A	B	C	D	E	F	G	H	I	J
K	L	M	N	O	P	Q	R	S	T
U	V	W	X	Y	Z	\$	&	_	'
()	-	^	{	}	@	~	`	

SmartMedia Card Error Messages

Display Message	Cause	Action
Err Card R/W	There is something wrong with the card.	Use a different card.
Err CardFull	The card is full.	<ol style="list-style-type: none"> 1. Use a different card. 2. Delete files you no longer need from the card (page E-90).
Err No Card	<ol style="list-style-type: none"> 1. The card is not set correctly in the card slot. 2. There is no card in the card slot or the card was removed part way through a card operation. 	<ol style="list-style-type: none"> 1. Remove the card and reinsert it correctly (page E-84). 2. Insert a card into the card slot. Never remove a card from the card slot while a card access operation is in progress.
Err Name	<ol style="list-style-type: none"> 1. A file with the same name as the one you are trying to use already exists. 2. You are trying to use a file name that is not allowed by MS-DOS. 	<ol style="list-style-type: none"> 1. Use a different name (page E-90). 2. Name files using the allowable characters (page E-92).
Err ReadOnly	Attempt to save a file using the same name as an existing file that is read only.	Save the new file to a different card or use another name.
Err Format	<ol style="list-style-type: none"> 1. The format of the card is not compatible with this keyboard. 2. The card is not formatted. 3. The card is damaged. 	<ol style="list-style-type: none"> 1. Change to a card that has the proper format. E-91 2. Format the card. E-91 3. Use a different card.
Err Mem Full	Keyboard memory became full while importing data from card.	<ol style="list-style-type: none"> 1. Delete data you no longer need from the user area that corresponds to the file you are trying to store. E-90 2. If you have song data stored in Song Memory (SG0 to 4), delete the song data you no longer need. E-64
Err Not SMF0	The file you are reading is not an SMF 0 format file.	Use SMF 0 format files only.
Err No File	The keyboard cannot find any file it can read on the card.	Use a card that contains data stored by this keyboard or compatible data from another device.
Err Protect	The card is write protected.	<ol style="list-style-type: none"> 1. Use a different card. 2. Remove the card's write protect sticker to enable data storage. E-83
Err Convert	There is not enough memory to save data produced by converting song data from SONG format to SMF format.	Delete files you no longer need from the keyboard's flash memory (page E-73).
Err WrongDat	The data on the card is corrupted.	Use other data or another card.

Disk Drive Error Messages (WK-3700 Only)

Display Message	Cause	Action
Err ReadOnly	Attempt to save a file using the same name as an existing file that is read only.	Save the new file to a different diskette or use another name.
Err Format	<ol style="list-style-type: none"> 1. The format of the diskette is not compatible with this keyboard. 2. The diskette is not formatted. 3. The diskette is damaged. 	<ol style="list-style-type: none"> 1. Change to a diskette that has the proper format. E-91 2. Format the diskette. E-91 3. Use a different diskette.
Err Disk R/W	The diskette is damaged.	Use a different diskette.
Err DiskFull	The diskette is full.	<ol style="list-style-type: none"> 1. Use a different diskette. 2. Delete any files you no longer need in order to make room for the data you want to save. E-90
Err Mem Full	Keyboard memory became full while importing data from diskette.	<ol style="list-style-type: none"> 1. Delete data you no longer need from the user area that corresponds to the file you are trying to store. E-90 2. If you have song data stored in Song Memory (SG0 to 4), delete the song data you no longer need. E-64
Err Not SMF0	The file you are reading is not an SMF 0 format file.	Use SMF 0 format files only
Err No Disk	<ol style="list-style-type: none"> 1. The diskette is not loaded in the drive correctly. 2. No diskette is loaded in the drive. 	<ol style="list-style-type: none"> 1. Eject the diskette from the drive and reload it. E-84 2. Load a diskette into the drive.
Err No File	The keyboard cannot find any file it can read on the diskette.	Use a diskette that contains data stored by this keyboard or compatible data from another device.
Err Protect	The diskette is write protected.	<ol style="list-style-type: none"> 1. Use a different diskette. 2. Close the diskette's write protect hole to enable data storage. E-85
Err Convert	There is not enough memory to save data produced by converting song data from SONG format to SMF format.	Delete files you no longer need from the keyboard's flash memory (page E-73).
Err WrongDat	The file you are reading is a wrong format file. The data on the diskette is corrupted.	Use other data or another diskette.
Err Name	A file with the same name as the one you are trying to use already exists on the floppy diskette.	Use a different name (page E-90).

Troubleshooting

Problem	Possible Cause	Action	See page
No keyboard sound	<ol style="list-style-type: none"> 1. Power supply problem. 2. Power is not turned on. 3. Volume setting is too low. 4. Playing in the accompaniment keyboard area while the MODE button setting is CASIO CHORD or FINGERED. 5. Local Control is off. 6. Mixer channel 1 is turned off. 7. Mixer channel 1 volume setting is too low. 8. The DSP volume parameter is set too low. 9. The Expression value of the file data played back on the SMF player is too low. 	<ol style="list-style-type: none"> 1. Correctly attach the AC adaptor, make sure that batteries poles (+/-) are facing correctly, and check to make sure that batteries are not dead. 2. Press the POWER button to turn on power. 3. Use the MAIN VOLUME knob to increase volume. 4. None of the accompaniment mode indicators are lit, which means Auto Accompaniment is turned off. 5. Turn on Local Control. 6. Use the Mixer to turn channel 1 on. 7. Use the Mixer to raise the volume setting for channel 1. 8. Increase the DSP parameter value. 9. Exit then re-enter the SMF Player Mode, or change the SMF Player play-along part. 	<p>E-14, 15</p> <p>E-19</p> <p>E-19</p> <p>E-32</p> <p>E-73</p> <p>E-40</p> <p>E-41</p> <p>E-43</p> <p>E-74</p>
Any of the following symptoms while using battery power.	Low battery power	Replace the batteries with a set of new ones or use the AC adaptor.	E-14, 15
<ul style="list-style-type: none"> • Dim power indicator • Instrument does not turn on. • Display that is flickering, dim, or difficult to read • Abnormally low speaker/headphone volume • Distortion of sound output • Occasional interruption of sound when playing at high volumes • Sudden power failure when playing at high volumes • Flickering or dimming of the display when playing at high volume • Continued sound output even after you release a key • A tone that is totally different from the one that is selected. • Abnormal rhythm pattern and demo tune play • Loss of power, sound distortion, or low volume when playing from a connected computer or MIDI device • Sudden power failure while reading from or writing to external storage media 			
Auto Accompaniment does not sound.	<ol style="list-style-type: none"> 1. Accompaniment volume is set to 000. 2. Auto Accompaniment part Channels 6 through 10 are turned off. 3. Auto Accompaniment part Channels 6 through 10 volume setting is too low. 	<ol style="list-style-type: none"> 1. Use the ACCOMP VOLUME button to increase the volume. 2. Use the Mixer to turn the channels on. 3. Use the Mixer to raise the volume setting for the applicable channel. 	<p>E-39</p> <p>E-40</p> <p>E-41</p>
Sound output does not change when key pressure is varied.	Touch response is turned off.	Press the TRANSPOSE/FUNCTION button to turn it on.	E-68
Playing the keyboard sounds two tones.	Layer is turned on.	Press the LAYER button to turn off layering.	E-65
Different tones sound when keys in different keyboard ranges are pressed.	Split is turned on.	Press the SPLIT button to turn off split.	E-66

Problem	Possible Cause	Action	See page
The key or tuning does not match when playing along with another MIDI machine.	<ol style="list-style-type: none"> 1. The tuning or transpose parameter is set to a value other than 00. 2. Mixer coarse tune, fine tune, and/or octave shift settings are values other than 00. 	<ol style="list-style-type: none"> 1. Change the transpose or tuning parameter value to 00. 2. Use the Mixer to change the coarse tune, fine tune, and/or octave shift settings to 00. 	E-68, 69 E-42
Parts suddenly drop out during song memory playback.	The number of tones being played at the same time exceeds the keyboard's limitation.	Use the Mixer to turn unneeded channels off and decrease the number of parts being played.	E-40
Some parts do not play at all during song memory playback.	<ol style="list-style-type: none"> 1. Channels are turned off. 2. Volume setting is too low. 	<ol style="list-style-type: none"> 1. Use the Mixer to turn channels on. 2. Use the Mixer to check the volume setting. 	E-40 E-41
Nothing happens when the LAYER or SPLIT button is pressed.	<ol style="list-style-type: none"> 1. One or more of the melody channels (2 through 4) is turned off. 2. The volume setting of one or more of the melody channels (2 through 4) is too low. 3. The keyboard is in record standby. 4. The SMF Player Mode is currently being use. 	<ol style="list-style-type: none"> 1. Use the Mixer to turn on Channels 2 through 4. 2. Use the Mixer to raise the volume setting of Channels 2 through 4. 3. The LAYER and SPLIT buttons are disabled during recording and record standby. 4. Turn off the SMF Player Mode. LAYER and SPLIT are not available while the SMF Player Mode is in use. 	E-40 E-41 E-65, 66 E-74
No sound is produced when playing MIDI data from a computer.	<ol style="list-style-type: none"> 1. MIDI cables are not connected properly. 2. Channel is turned off, or volume setting is too low. 	<ol style="list-style-type: none"> 1. Connect MIDI cables properly. 2. Use the Mixer to turn the channel on, or raise the volume setting. 	E-79 E-40, 41
Playing on the keyboard produces an unnatural sound when connected to a computer.	The computer's MIDI Thru function is turned on.	Turn off the MIDI Thru function on the computer or turn off Local Control on the keyboard.	E-73
Cannot record chord accompaniment data on a computer.	Accomp/Song MIDI Out is turned off.	Turn on Accomp/Song MIDI Out.	E-73
The keyboard starts up abnormally when it is turned on.	<ol style="list-style-type: none"> 1. Flash memory is corrupted. There is something wrong with the card. 2. The keyboard detected abnormal flash memory data and is automatically resetting the keyboard system. 	<ol style="list-style-type: none"> 1. a. Remove the batteries from the keyboard and disconnect the AC adaptor and press the POWER button. b. Reload the batteries and/or reconnect the AC adaptor, and then press the POWER button again to turn on power. c. Use the TRANSPOSE/FUNCTION button to perform the system reset operation. <ul style="list-style-type: none"> • If this does not solve the problem, contact your nearest authorized CASIO Service Provider to request repair. 2. Wait (about 40 seconds) until the "Pls Wait" message disappears from the display. 	E-73



Problem	Possible Cause	Action	See page
A downloaded tone with waveform contains noise or keyboard operations become abnormal when user data is selected.	Someone may have turned off the keyboard while data was being stored in Flash memory or something else has caused Flash memory contents to become corrupted for some reason.	Use the TRANSPOSE/FUNCTION button to perform the system reset operation. If this does not correct the problem, contact your nearest authorized CASIO Service Provider to request maintenance.	E-73
Cannot save data to a card.	<ol style="list-style-type: none"> 1. The card is write-protected. 2. The card is not inserted correctly into the card slot. 3. There is not enough space left on the card. 4. You are trying to use a card whose voltage or capacity is not supported by this keyboard. 5. The card is damaged. 	<ol style="list-style-type: none"> 1. Remove the write-protect sticker from the card. 2. Correctly insert the card into the card slot. 3. Use a different card or delete files you no longer need from the card you are using. 4. Use only a card of the voltage and capacity specified for this keyboard. 5. Use a different card. 	<p>E-83</p> <p>E-84</p> <p>E-90</p> <p>E-83</p>
Cannot recall data from a card.	<ol style="list-style-type: none"> 1. The card is not inserted correctly into the card slot. 2. There is not enough space available in the area into which you are trying to import the data. 3. You are trying to use a card whose voltage or capacity is not supported by this keyboard. 4. The card is damaged. 	<ol style="list-style-type: none"> 1. Correctly insert the card into the card slot. 2. Delete rhythm, SMF, or tone with wave data currently in the keyboard's Flash memory to make room from the imported data. 3. Use only a card of the voltage and capacity specified for this keyboard. 4. Use a different card. 	<p>E-84</p> <p>E-73</p> <p>E-83</p>
A tone's quality and volume sounds slightly different depending where it is played on the keyboard.	<p>This is an unavoidable result of the digital sampling process,* and does not indicate malfunction.</p> <p>* Multiple digital samples are taken for the low range, middle range, and high range of the original musical instrument. Because of this, there may be a very slight difference in tonal quality and volume between sample ranges.</p>		

Specifications

Model:	WK-3700/WK-3200																
Keyboard:	76 standard-size keys, 6 1/4 octaves with touch response (OFF/1/2/3)																
Tones:	332 Advanced Tones + 200 Preset Tones + 18 Drum Sets + 100 standard user tones + 20 user tones with waves* + 4 user drum sets with waves* + 50 drawbar organ tones + 100 user drawbar organ tones (824 tones total); layer/split																
Polyphony:	32 notes maximum (10 for certain tones)																
Drawbar Organ Function Drawbars: Percussion: Click:	9 (16', 5 1/3', 8', 4', 2 2/3', 2', 1 3/5', 1 1/3', 1') Second, Third On, Off																
Effects:	DSP (200 types: internal, 100 user areas) + Reverb (16 types) + Chorus (16 types) + Equalizer (10 types, 4 bands)																
Auto Accompaniment Rhythm Patterns: Tempo: Chords: Rhythm Controller: Accomp Volume: One-touch Presets: Auto Harmonize:	176 (internal, 16 user areas*) Variable (226 steps, ♩ = 30 to 255) 3 fingering methods (CASIO CHORD, FINGERED, FULL RANGE CHORD) START/STOP, INTRO/ENDING 1 and 2, VARIATION/FILL-IN 1 and 2, SYNCHRO/FILL-IN NEXT 0 to 127 (128 steps) Recalls settings for tone, tempo, layer on/off, and harmonize on/off in accordance with rhythm. 10 types : Automatic addition of notes that harmonize with melody note in accordance with specified Auto Accompaniment chords.																
Memory Function Songs: Recording Tracks: Recording Methods: Memory Capacity: Edit Function:	5 6 (2 through 6 are melody tracks) Real-time, step Approximately 10,000 notes (total for 5 songs) Equipped																
Demo Tunes:	3 <table border="1"> <thead> <tr> <th>Tune Number</th> <th>Name</th> <th>Composer</th> <th>Play Time</th> </tr> </thead> <tbody> <tr> <td>0</td> <td>White Winter</td> <td>Hage Software</td> <td>2:32</td> </tr> <tr> <td>1</td> <td>Serendipity Waltz</td> <td>TECH-NOTE INTERNATIONAL LTD.</td> <td>2:01</td> </tr> <tr> <td>2</td> <td>Street Beatz</td> <td>Steve Turner</td> <td>2:10</td> </tr> </tbody> </table>	Tune Number	Name	Composer	Play Time	0	White Winter	Hage Software	2:32	1	Serendipity Waltz	TECH-NOTE INTERNATIONAL LTD.	2:01	2	Street Beatz	Steve Turner	2:10
Tune Number	Name	Composer	Play Time														
0	White Winter	Hage Software	2:32														
1	Serendipity Waltz	TECH-NOTE INTERNATIONAL LTD.	2:01														
2	Street Beatz	Steve Turner	2:10														
Synthesizer Function Parameters:	Attack time; release time; resonance; cutoff frequency; vibrato type; vibrato delay; vibrato depth; vibrato rate; octave shift; level; touch sense; reverb send; chorus send; DSP line; DSP type; DSP parameter; Modulation Assign; Modulation Depth (WK-3200 only)																



<p>Registration Memory Number of Setups: Memory Contents:</p>	<p>32 (4 setups x 8 banks) Tone, Rhythm, Tempo, Layer on/off, Split on/off, Split point, Harmonize on/off, Mixer settings (Channels 1 to 10), Effect settings, Touch Response settings, Assignable jack setting, Transpose, Tuning, Accompaniment volume setting, Pitch bend range, Auto Harmonize type, MODE button setting, Synchro standby state, Mixer Hold, DSP Hold, Synthesizer Mode parameters</p>
<p>Mixer Function Channels: Parameters:</p>	<p>16 Tone; part on/off; volume; pan pot; octave shift; coarse tune; fine tune; reverb send; chorus send; DSP line; DSP level, DSP pan, DSP system reverb send, DSP system chorus send</p>
<p>MIDI:</p>	<p>16 multi-timbre receive, GM Level 1 standard</p>
<p>Other Functions Pitch Bend Range: Modulation: Transpose: Tuning: LCD:</p>	<p>Adjustable (12 semitones upwards and downwards) Equipped 49 steps (-24 semitones to +24 semitones) Variable (A4 = approximately 440Hz ±100 cents) Adjustable contrast</p>
<p>SMF Player: Supported Format:</p>	<p>Flash memory storage for up to 200 files* SMF0</p>
<p>Flash Memory Capacity: Shared Area:</p>	<p>4MB Approximately 3.5MB (waveform data, accompaniment data, SMF data) Further storage of waveform, accompaniment, and SMF data becomes impossible after the total of such data reaches approximately 3.5MB.</p>
<p>Card Slot Functions:</p>	<p>3.3V SmartMedia™ (8MB, 16MB, 32MB, 64MB, 128MB) Save and load of user tones, user songs, and registration data; playback of SMF; card formatting; file delete; file rename</p>
<p>Floppy Disk Drive (WK-3700 only) Type: Formats: Functions:</p>	<p>3.5" FDD 2DD (720KB MS-DOS format) 2HD (1.44MB MS-DOS format) Save and load of user tones, user songs, and registration data; playback of SMF; disk formatting; file delete; file rename</p>

Specifications

<p>Terminals</p> <p>MIDI Terminals: Sustain/ Assignable Terminal:</p> <ul style="list-style-type: none"> •WK-3700 <p>Headphones:</p> <p>Line Out (R, L/MONO):</p> <ul style="list-style-type: none"> •WK-3200 <p>Headphone/Output Terminal:</p> <p>Power Supply Terminal:</p>	<p>IN, OUT</p> <p>Standard jack (sustain, sostenuto, soft, rhythm start/stop)</p> <p>Stereo standard jack</p> <p>Output Impedance : 200Ω</p> <p>Output Voltage : 250mV (RMS) MAX</p> <p>Standard jack x 2</p> <p>Output Impedance : 3kΩ</p> <p>Output Voltage : 1.5V (RMS) MAX</p> <p>Stereo standard jack</p> <p>Output Impedance: 200Ω</p> <p>Output Voltage: 5.5V (RMS) MAX</p> <p>12V DC</p>
<p>Power Supply:</p> <p>Batteries:</p> <p>Battery Life:</p> <p>AC Adaptor:</p> <p>Auto Power Off:</p>	<p>Dual power supply system</p> <p>6 D-size batteries</p> <p>Approximately 4 hours continuous operation on alkaline batteries</p> <p>AD-12</p> <p>Turns power off approximately six minutes after last key operation. Enabled under battery power only, can be disabled manually.</p>
<p>Speaker Output:</p>	<p>6.1W + 6.1W</p>
<p>Power consumption:</p>	<p>12V --- 18W</p>
<p>Dimensions:</p>	<p>122.3 x 42.3 x 16.0 cm (48 ³/₁₆ x 16 ¹¹/₁₆ x 6 ⁵/₁₆ inch)</p>
<p>Weight:</p>	<p>WK-3700: Approximately 10.0 kg (22.0 lbs) (without batteries)</p> <p>WK-3200: Approximately 9.5 kg (20.9 lbs) (without batteries)</p>

* The same memory area is used to store waveform data, accompaniment data, and SMF data.



Care of your Instrument

Avoid heat, humidity or direct sunlight.

Do not overexpose the instrument to direct sunlight, or place it near an air conditioner, or in any extremely hot place.

Do not use near a TV or radio.

This instrument can cause video or audio interference with TV and radio reception. If this happens, move the instrument away from the TV or radio.

Do not use lacquer, thinner or similar chemicals for cleaning.

Clean the instrument with a soft cloth dampened in a weak solution of water and a neutral detergent. Soak the cloth in the solution and squeeze until it is almost dry.

Avoid use in areas subjected to temperature extremes.

Extremely high or low temperature can cause figures on the LCD screen to become dim and difficult to read. This condition should correct itself when the instrument is brought back to normal temperature.

NOTE

- You may notice lines in the finish of the case of this instrument. These lines are a result of the molding process used to shape the plastic of the case. They are not cracks or breaks in the plastic, and are no cause for concern.
-

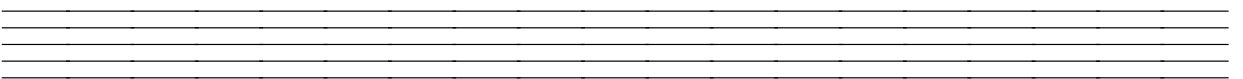
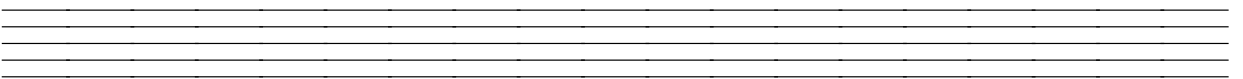
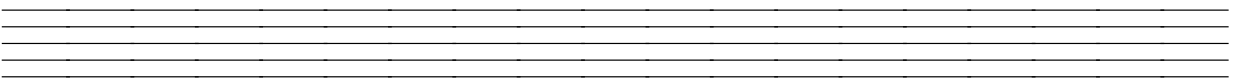
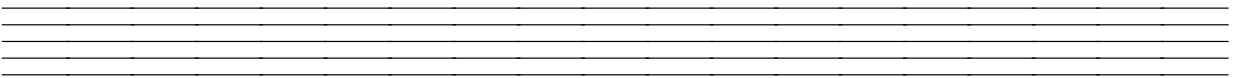
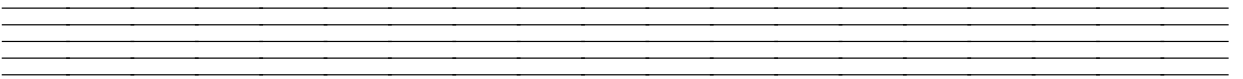
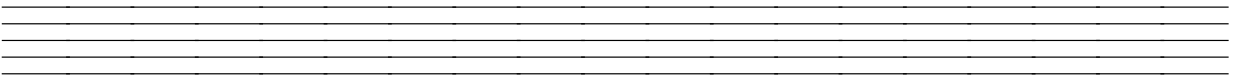
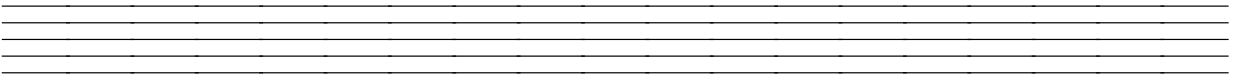
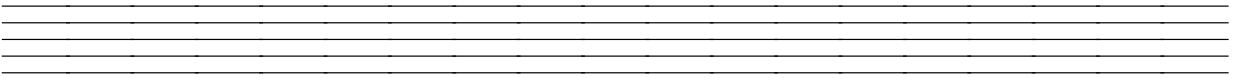
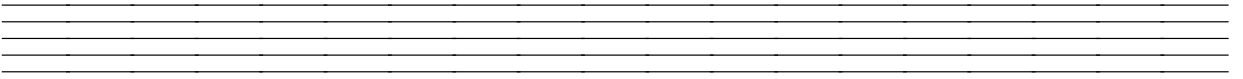
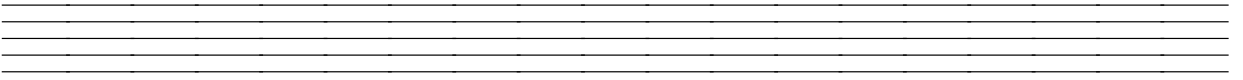
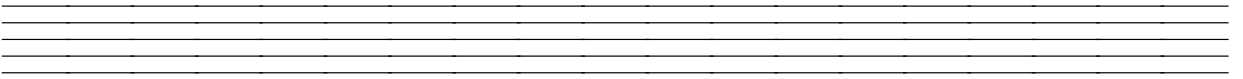

Tone List

- ①: No.
- ②: Tone Group
- ③: Maximum Polyphony
- ④: Range Type

- ⑤: Tone Name
- ⑥: DSP Type

④: Program Change

⑤: Bank Select MSB

Advanced Tones

①	②	③	④	⑤	⑥	⑦	⑧	①	②	③	④	⑤	⑥	⑦	⑧
0	PIANO	STEREO GRAND PIANO	0	51	16	N	RvbHall1	48	CHROM.PERC	CELESTA	8	48	32	N	Reflect
1	PIANO	STEREO MELLOW PIANO	0	52	16	N	GateRvb2	49	CHROM.PERC	VIBRAPHONE	11	50	32	N	Reflect
2	PIANO	STEREO BRIGHT PIANO	1	50	16	N	Equalize	50	CHROM.PERC	PHASER MARIMBA	12	50	32	N	PhaDly 2
3	PIANO	GRAND PIANO	0	48	32	N	RvbHall1	51	CHROM.PERC	DELAY GLOCKENSPIEL	9	49	32	+1	ChoDly 2
4	PIANO	ROCK PIANO	1	49	32	N	Equalize	52	CHROM.PERC	ROTARY CELESTA	8	49	32	N	RotRef 2
5	PIANO	MODERN PIANO	1	51	16	N	Equalize	53	ORGAN	ROTARY DRAWBAR	16	52	16	N	Rotary 2
6	PIANO	DANCE PIANO	1	53	16	N	Enha Div	54	ORGAN	ROTARY PERC.ORGAN 1	17	52	16	N	Rotary 2
7	PIANO	MELLOW PIANO	0	50	32	N	Equalize	55	ORGAN	ROTARY PERC.ORGAN 2	17	54	16	N	RotRef 1
8	PIANO	BRIGHT PIANO	1	48	32	N	Enhancer	56	ORGAN	70'S ORGAN	17	49	32	N	Rotary 1
9	PIANO	SYNTH-STR PIANO	0	54	16	N	Cho Flan	57	ORGAN	TREMOLO ORGAN	16	49	32	N	Cho Trem
10	PIANO	STRINGS PIANO	1	52	16	N	RvbHall1	58	ORGAN	JAZZ DRAWBAR	17	53	16	N	RotRef 1
11	PIANO	VOICE PIANO	0	53	16	N	Reflect	59	ORGAN	ROCK ORGAN	18	48	16	N	Rotary 2
12	PIANO	ELEC.GRAND PIANO	2	48	32	N	Equalize	60	ORGAN	OVD ROTARY ORGAN	16	54	32	N	Od Rot 2
13	PIANO	HARPSICHORD	6	51	32	N	CmpChoRf	61	ORGAN	ROTARY ELEC.ORGAN	16	53	32	N	Rotary 2
14	PIANO	GRAND PIANO WIDE	0	49	32	N	Reflect	62	ORGAN	CHURCH ORGAN 1	19	48	16	N	RvbHall2
15	PIANO	AMBIENT PIANO	0	55	16	N	St.Delay	63	ORGAN	CHAPEL ORGAN	19	51	32	N	GateRvb2
16	PIANO	1 OCTAVE PIANO	3	51	16	N	Equalize	64	ORGAN	ACCORDION	21	48	16	N	Reflect
17	PIANO	2 OCTAVE PIANO	3	50	16	N	RvbRoom2	65	ORGAN	BANDONEON	23	48	16	N	Reflect
18	PIANO	MODERN E.G.PIANO	2	50	16	N	ChoDly 1	66	ORGAN	HARMONICA	22	48	32	N	Reflect
19	PIANO	COMP.PIANO	0	56	32	N	CmpEndDly	67	ORGAN	DRAWBAR ORGAN 1	16	48	32	N	Reflect
20	PIANO	HONKY-TONK 1	3	48	16	N	Enhancer	68	ORGAN	DRAWBAR ORGAN 2	16	50	32	N	Rotary 1
21	PIANO	BRIGHT HARPSICHORD	6	52	32	N	CmpChoRf	69	ORGAN	ELEC.ORGAN	16	51	32	N	Reflect
22	PIANO	COUPLED HARPSICHORD	6	49	16	N	CmpChoRf	70	ORGAN	PERC.ORGAN 1	17	48	16	N	Reflect
23	E.PIANO	ELEC.PIANO 1	4	48	32	N	Chorus 3	71	ORGAN	PERC.ORGAN 2	17	51	16	N	Rotary 2
24	E.PIANO	ELEC.PIANO 2	5	49	16	N	Chorus 3	72	ORGAN	JAZZ ORGAN	17	50	16	N	Reflect
25	E.PIANO	FM ELEC.PIANO	5	48	16	N	Chorus 3	73	ORGAN	OVD ROCK ORGAN	18	49	16	N	OdRRef1
26	E.PIANO	DYNO ELEC.PIANO	4	49	32	N	Chorus 3	74	ORGAN	TAPE ORGAN	20	50	16	N	Cho Dly4
27	E.PIANO	60'S ELEC.PIANO	4	52	32	N	Auto Pan	75	ORGAN	CHURCH ORGAN 2	19	49	16	N	GateRvb2
28	E.PIANO	MELLOW E.PIANO	4	53	16	N	CmpChoRf	76	ORGAN	OCTAVE ACCORDION	21	49	16	N	CmpChoRf
29	E.PIANO	POP ELEC.PIANO	4	50	16	N	Equalize	77	ORGAN	NEO BANDONEON	23	49	16	N	ChoDly 4
30	E.PIANO	TREMOLO E.PIANO	4	56	32	N	Cho Trem	78	ORGAN	SLOW HARMONICA	22	49	32	N	RvbRoom2
31	E.PIANO	SOFT E.PIANO	5	51	16	N	Equalize	79	ORGAN	WAH HARMONICA	22	50	32	N	LWdDsDly
32	E.PIANO	GLASS E.PIANO	4	51	16	N	Equalize	80	GUITAR	PURE ACOUSTIC GUITAR	25	49	32	-1	Equalize
33	E.PIANO	SYNTH-STR E.PIANO 1	4	55	16	N	Equalize	81	GUITAR	NYLON STR.GUITAR	24	48	32	-1	Equalize
34	E.PIANO	CLAVI	7	48	32	N	Dist 1	82	GUITAR	STEEL STR.GUITAR	25	48	32	-1	Equalize
35	E.PIANO	AUTO WAH E.PIANO	4	57	32	N	Auto Wah	83	GUITAR	JAZZ GUITAR	26	48	32	-1	CmpChoRf
36	E.PIANO	PHASER E.PIANO	4	58	32	N	PhaAPan1	84	GUITAR	CHORUS CLEAN GUITAR	27	53	32	-1	CmpEndDly
37	E.PIANO	MODERN E.PIANO	5	50	16	N	Enha Dly	85	GUITAR	ROTARY GUITAR	27	54	32	-1	RotRef 1
38	E.PIANO	WARM ELEC.PIANO	4	59	32	N	Cho Trem	86	GUITAR	CRUNCH ELEC.GUITAR	27	52	32	-1	CrnDelay
39	E.PIANO	ELEC.PIANO PAD	4	54	16	N	StPhaser	87	GUITAR	OVD FRONT GUITAR	29	49	32	-1	CmpOdDly
40	E.PIANO	SYNTH-STR E.PIANO 2	5	53	16	N	Equalize	88	GUITAR	FEEDBACK DIST.GT	30	52	16	-1	DistDly1
41	E.PIANO	STRINGS E.PIANO	5	54	16	N	ChoDly 1	89	GUITAR	MUTE DIST.GUITAR	28	49	32	-1	MetalDly
42	E.PIANO	RESONANCE CLAVI	7	50	32	N	Auto Wah	90	GUITAR	MELLOW NYLON GUITAR	24	51	16	-1	ChoDly 3
43	E.PIANO	PULSE CLAVI	7	49	32	N	CmpEndDly	91	GUITAR	12 STRING GUITAR	25	50	16	-1	Equalize
44	E.PIANO	LA CLAVI	7	51	32	N	Cho Dly4	92	GUITAR	BRIGHT ACOUSTIC GUITAR	25	52	32	-1	Enha Dly
45	CHROM.PERC	TREMOLO VIBRAPHONE	11	48	32	N	Cho Trem	93	GUITAR	CHORUS STEEL GUITAR	25	51	16	-1	ChoDly 4
46	CHROM.PERC	MARIMBA	12	48	32	N	Reflect	94	GUITAR	UKULELE	24	49	32	N	CmpChoRf
47	CHROM.PERC	GLOCKENSPIEL	9	48	32	+1	Reflect	95	GUITAR	BANJO	105	48	32	N	Equalize

Appendix

1	2	3	4	5	6	7	8
96	GUITAR	OCTAVE JAZZ GUITAR	26	50	16	-1	RvbRoom3
97	GUITAR	CHORUS JAZZ GUITAR	26	51	32	-1	OdChorus
98	GUITAR	CLEAN GUITAR	27	48	32	-1	Equalize
99	GUITAR	ELEC.GUITAR FRONT	27	51	32	-1	Equalize
100	GUITAR	ELEC.GUITAR REAR	27	50	32	-1	Equalize
101	GUITAR	TREMLOLO GUITAR	29	55	32	-1	Cho Trem
102	GUITAR	MUTE GUITAR	28	48	32	-1	Equalize
103	GUITAR	OVERDRIVE GUITAR	29	48	16	-1	CmpDelay
104	GUITAR	OVD REAR GUITAR	29	50	32	-1	Ovrdrive
105	GUITAR	DISTORTION FRONT GT	30	50	32	-1	DistDly2
106	GUITAR	MORE DISTORTION GT	30	51	16	-1	DistDly2
107	GUITAR	TOUCH WAH OVD GT	30	54	16	-1	AwhCrDly
108	GUITAR	DISTORTION GUITAR	30	48	16	-1	CmpDelay
109	GUITAR	FEEDBACK GUITAR	30	49	16	-1	CmpCrDly
110	GUITAR	DISTORTION CLEAN GT	30	53	32	-1	CmpCrDly
111	BASS	ACOUSTIC BASS 1	32	48	32	-1	Limiter
112	BASS	ACOUSTIC BASS 2	32	49	32	-1	Limiter
113	BASS	RIDE BASS	32	50	16	-1	RvbRoom1
114	BASS	FINGERED BASS 1	33	48	32	-1	Limiter
115	BASS	FINGERED BASS 2	33	49	32	-1	Limiter
116	BASS	PICKED BASS	34	48	32	-1	CmpEnDly
117	BASS	FRETLESS BASS	35	48	32	-1	ChoDly1
118	BASS	SLAP BASS	37	48	32	-1	Comp 2
119	BASS	SAW SYNTH-BASS 1	38	48	16	-1	Chorus 1
120	BASS	ANALOG SYNTH-BASS	38	52	32	-1	PhaCho 1
121	BASS	CHORUS FINGERED BASS	33	50	16	-1	Crn Cho
122	BASS	ROCK PICKED BASS	34	49	32	-1	OdChorus
123	BASS	FLAN.FRETLESS BASS	35	49	16	-1	Cho Flan
124	BASS	FUNKY SLAP BASS	37	49	32	-1	AwhCrDly
125	BASS	SOB SYNTH-BASS 1	39	48	32	-1	Od Rot 1
126	BASS	RESO.SOB BASS	39	50	32	-1	Enha Cho
127	BASS	RESO.SAW BASS 1	38	53	32	-1	AwhCrDly
128	BASS	RESO.SAW BASS 2	38	49	16	-1	PhaDly 2
129	BASS	DISTORTION SOB BASS	39	51	16	-1	DistDly1
130	BASS	DIGITAL BASS 1	39	52	32	-1	Comp 2
131	BASS	DIGITAL BASS 2	39	55	16	-1	Chorus 2
132	BASS	ACID BASS	38	50	32	-1	Enhancer
133	BASS	SAW SYNTH-BASS 2	38	54	32	-1	Equalize
134	BASS	TRI SYNTH-BASS	39	53	32	-1	Equalize
135	BASS	SINE BASS	39	54	32	-1	Comp 1
136	BASS	FAT SYNTH-BASS	39	56	16	N	CmpEnDly
137	BASS	ORGAN BASS 1	38	55	32	-1	Comp 1
138	ORCHESTRA	VIOLIN	40	48	32	N	GateRvb2
139	ORCHESTRA	CELLO	42	48	32	-1	GateRvb2
140	ORCHESTRA	VIOLA	41	48	32	N	GateRvb2
141	ORCHESTRA	PIZZICATO ENSEMBLE	45	49	16	N	RvbHall1
142	ORCHESTRA	HARP	46	48	32	N	Reflect
143	ORCHESTRA	SLOW VIOLIN	40	49	32	N	RvbHall2
144	ORCHESTRA	SLOW CELLO	42	49	32	-1	RvbHall2
145	ORCHESTRA	PIZZICATO	45	48	32	N	Reflect
146	ORCHESTRA	HARPS	46	49	16	N	Reflect
147	ENSEMBLE	STEREO STRINGS	48	51	16	N	RvbPlate
148	ENSEMBLE	STRING ENSEMBLE	48	48	32	N	RvbRoom3
149	ENSEMBLE	SLOW STRINGS	49	48	32	N	ChoDly 3
150	ENSEMBLE	CHAMBER	49	49	16	N	Reflect
151	ENSEMBLE	PURE SYNTH-STRINGS	50	50	16	N	ChoDly 3
152	ENSEMBLE	SYNTH-STRINGS 1	50	48	32	N	ChoDly 3
153	ENSEMBLE	70'S SYNTH-STR	50	51	16	N	RevHall1
154	ENSEMBLE	80'S SYNTH-STR	50	52	16	N	ChoDly 4
155	ENSEMBLE	STEREO CHOIR	52	50	16	N	RvbHall1
156	ENSEMBLE	VOICE UUH	53	49	16	N	RvbRoom1
157	ENSEMBLE	VOICE DOO	53	48	32	N	RvbRoom1
158	ENSEMBLE	SYNTH-VOICE 1	54	48	32	N	Chorus 4
159	ENSEMBLE	SYNTH-VOICE 2	54	49	32	N	ChoDly 3
160	ENSEMBLE	SCAT VOICE 1	53	52	32	N	ChoDly 4
161	ENSEMBLE	SCAT VOICE 2	53	53	32	N	ChoDly 2
162	ENSEMBLE	SCAT VOICE 3	53	54	32	-1	ChoDly 4
163	ENSEMBLE	BRIGHT STRINGS	48	49	32	N	RvbHall1
164	ENSEMBLE	WELL STRINGS	48	52	16	N	RvbHall1
165	ENSEMBLE	MELLOW STRINGS	49	50	32	N	RvbHall1
166	ENSEMBLE	ORCHESTRA STRINGS 1	49	51	16	N	RvbRoom3
167	ENSEMBLE	ORCHESTRA STRINGS 2	49	52	16	N	RvbHall1
168	ENSEMBLE	RESO SYNTH-STRINGS	51	48	32	N	ChoDly 3
169	ENSEMBLE	PHASER SYNTH-STRINGS	51	49	16	N	PhaAPan2
170	ENSEMBLE	OLD STRINGS ENSEMBLE	49	53	32	N	OdChorus
171	ENSEMBLE	CHOIR STRINGS	48	53	16	N	RvbHall1
172	ENSEMBLE	SYNTH-CHOIR	52	51	16	N	SIXDelay
173	ENSEMBLE	SYNTH-DOO	53	50	16	N	DistDly1
174	ENSEMBLE	MAGIC VOICE DOO	53	51	32	N	PhaDly 2
175	ENSEMBLE	WAH SYNTH-VOICE	54	55	32	N	AwhCrDly
176	ENSEMBLE	VOICE PAD	54	53	16	N	FlanDly3
177	ENSEMBLE	BLOW VOICE	54	51	16	N	DistDly1
178	ENSEMBLE	NOISY SYNTH-VOICE	54	54	16	N	FlanDly2
179	ENSEMBLE	POP HIT 1	55	52	16	N	Equalize
180	ENSEMBLE	POP HIT 2	55	53	16	N	FlanDly1
181	ENSEMBLE	BASS HIT	55	49	16	N	DistDly1
182	ENSEMBLE	PIANO HIT	55	54	16	N	GateRvb2
183	ENSEMBLE	ORGAN HIT	55	55	16	N	Rotary 2
184	ENSEMBLE	ORCHESTRA HIT 1	55	48	16	N	RvbHall1
185	ENSEMBLE	TECHNO HIT	55	56	16	N	MetalDly
186	BRASS	PURE TRUMPET	56	52	32	N	GateRvb1
187	BRASS	TROMBONE	57	50	16	-1	GateRvb2
188	BRASS	MUTE TRUMPET	59	48	32	N	Enhancer
189	BRASS	STEREO BRASS	61	50	16	N	RvbPlate
190	BRASS	BRASS ENSEMBLE	61	51	16	N	Enha Dly
191	BRASS	DEEP SYNTH-BRASS 1	62	51	16	N	Enha Dly
192	BRASS	SOFT SYNTH-BRASS	63	51	16	N	Enha Dly
193	BRASS	VINTAGE SYNTH-BRASS	63	48	16	N	RvbHall2
194	BRASS	TRUMPET 1	56	51	16	N	GateRvb2
195	BRASS	MELLOW TRUMPET	56	50	16	N	RvbHall1
196	BRASS	MELLOW TROMBONE	57	48	16	-1	RvbHall1
197	BRASS	BRIGHT TROMBONE	57	49	32	-1	RvbHall1
198	BRASS	TUBA	58	48	32	-1	RvbHall1
199	BRASS	FRENCH HORN	60	48	16	-1	RvbHall1
200	BRASS	TRUMPET 2	56	53	32	N	GateRvb1
201	BRASS	TROMBONE SECTION	57	51	16	-1	GateRvb2
202	BRASS	OCTAVE FRENCH HORN	60	50	16	-1	RvbHall1
203	BRASS	BRASS	61	48	32	N	RvbHall2
204	BRASS	BRASS SFZ	61	53	16	N	Comp 2
205	BRASS	BRASS+FRENCH HORN	61	55	16	N	RvbHall2
206	BRASS	OCTAVE BRASS	61	54	16	N	RvbHall2
207	BRASS	GATE BRASS	61	56	16	N	GateRvb1
208	BRASS	DEEP SYNTH-BRASS 2	62	53	16	N	Enha Dly
209	BRASS	ANALOG BRASS 1	62	48	32	N	Comp 2
210	BRASS	ANALOG BRASS 2	62	54	32	N	Equalize
211	BRASS	WARM SYNTH-BRASS	63	52	16	N	Delay
212	BRASS	SLOW SYNTH-BRASS	63	49	16	N	ChoDly 4
213	BRASS	SOR SYNTH-BRASS	62	52	16	N	Delay

1	2	3	4	5	6	7	8
214	BRASS	SAW SYNTH-BRASS	63	53	16	N	Enha Cho
215	BRASS	LA SYNTH-BRASS	63	50	16	N	PhaDly 1
216	REED	BREATHY ALTO SAX	65	50	16	-1	RvbHall1
217	REED	BREATHY TENOR SAX	66	50	16	-1	RvbHall1
218	REED	MELLOW SOPRANO SAX	64	49	16	N	CompEndly
219	REED	PURE ALTO SAX	65	51	32	-1	GateRvb2
220	REED	PURE TENOR SAX	66	51	16	-1	GateRvb2
221	REED	CLARINET	71	49	16	N	Reflect
222	REED	OBOE	68	48	32	N	GateRvb2
223	REED	SOPRANO SAX	64	48	32	N	Equalize
224	REED	ALTO SAX	65	48	32	-1	Equalize
225	REED	BRIGHT ALTO SAX	65	54	32	-1	Equalize
226	REED	TENOR SAX	66	48	32	-1	Equalize
227	REED	BARITONE SAX	67	48	32	-1	Equalize
228	REED	TREMOLO ALTO SAX	65	49	16	-1	Tremolo
229	REED	TREMOLO TENOR SAX	66	49	16	-1	Tremolo
230	REED	ALTO SAXYS	65	52	16	-1	Equalize
231	REED	TENOR SAXYS	66	52	16	-1	Equalize
232	REED	STACK BARITONE SAX	67	49	16	-1	Comp 2
233	REED	WAB BARITONE SAX	67	50	16	-1	Auto Wah
234	REED	MELLOW CLARINET	71	48	32	N	GateRvb2
235	REED	SYNTH-OBOE	68	49	16	N	ChoDly 4
236	PIPE	PURE FLUTE	73	49	16	N	GateRvb2
237	PIPE	FLUTE	73	48	32	N	Reflect
238	PIPE	MELLOW FLUTE	73	50	16	N	Reflect
239	PIPE	PICCOLO	72	48	32	+1	Equalize
240	PIPE	PAN FLUTE	75	48	32	N	GateRvb2
241	PIPE	BOTTLE BLOW	76	48	32	N	Equalize
242	PIPE	REORDER	74	48	32	N	GateRvb2
243	PIPE	WHISTLE	78	48	32	N	Tremolo
244	PIPE	PICCOLO ENSEMBLE	72	49	16	+1	Equalize
245	PIPE	BREATHY FLUTE	73	53	16	N	Tremolo
246	PIPE	OCTAVE FLUTE	73	51	16	N	Equalize
247	PIPE	FLUTE+REED	73	52	16	N	SIXDelay
248	PIPE	SYNTH-PAN FLUTE	75	49	16	N	AWnChDly
249	PIPE	SYNTH-RECORDER	74	49	16	N	ChoDly 4
250	PIPE	WHISTLES	78	49	16	N	ChoDly 4
251	SYNTH-LEAD	SAWTOOTH LEAD	81	48	16	N	Enha Diy
252	SYNTH-LEAD	MELLOW SAW LEAD	81	53	16	N	Enha Diy
253	SYNTH-LEAD	GR LEAD 1	81	54	16	N	PhaDly 2
254	SYNTH-LEAD	SQUARE LEAD 1	80	48	16	N	ChoDly 2
255	SYNTH-LEAD	SQUARE LEAD 2	80	51	16	N	ChoDly 2
256	SYNTH-LEAD	VOX SOR LEAD	80	52	16	N	ChoDly 4
257	SYNTH-LEAD	CALLOPPE LEAD	82	48	16	N	Equalize
258	SYNTH-LEAD	CHIFF LEAD 1	83	48	16	N	Comp 1
259	SYNTH-LEAD	CHARANG LEAD	84	48	16	N	Equalize
260	SYNTH-LEAD	GT SYNTH-LEAD 1	84	49	16	N	PhaAPan1
261	SYNTH-LEAD	SOLO VOX	85	48	16	N	PhaDly 1
262	SYNTH-LEAD	FIFTH LEAD	86	48	16	N	Auto Wah
263	SYNTH-LEAD	HUSKY SAW	86	49	16	N	PhaDly 1
264	SYNTH-LEAD	BASS LEAD 1	87	48	16	N	Chorus 2
265	SYNTH-LEAD	BASS LEAD 2	87	50	16	N	LFO Wah
266	SYNTH-LEAD	VOX SAW LEAD	81	57	16	N	RgChoDly
267	SYNTH-LEAD	SQUARE LEAD 3	80	53	16	N	FlanDly1
268	SYNTH-LEAD	MELLOW SOR LEAD	80	54	16	N	Tremolo
269	SYNTH-LEAD	ADVANCED CALLOPPE	82	49	16	N	RvbPlate
270	SYNTH-LEAD	SEO SAW 1	81	55	16	N	Equalize
271	SYNTH-LEAD	REED SAW	81	56	16	N	Enha Cho
272	SYNTH-LEAD	PIPE LEAD	82	50	16	N	Reflect
273	SYNTH-LEAD	ATTACK SQR 1	80	55	16	N	Comp 2
274	SYNTH-LEAD	ATTACK SQR 2	80	56	16	N	3Tap Dly
275	SYNTH-LEAD	PLUCK LEAD 1	84	50	16	N	FlanDly2
276	SYNTH-LEAD	PLUCK LEAD 2	84	51	16	N	FlanDly2
277	SYNTH-LEAD	FIFTH MELLOW	86	50	16	N	SIXDelay
278	SYNTH-LEAD	FOURTH LEAD	86	51	16	N	Auto Pan
279	SYNTH-LEAD	DETUNE SAW	81	51	16	N	Chorus 2
280	SYNTH-LEAD	RESONANCE SAW LEAD	81	58	16	N	Phaser
281	SYNTH-LEAD	GR LEAD 2	81	59	32	N	CompOrDly
282	SYNTH-LEAD	GR LEAD X	81	60	32	N	ChoDly 2
283	SYNTH-LEAD	VOX LEAD 1	85	50	16	N	FlanDly2
284	SYNTH-LEAD	REED LEAD	87	51	16	N	Equalize
285	SYNTH-LEAD	SQUARE WAVE 1	80	49	32	N	Auto Pan
286	SYNTH-LEAD	SQUARE WAVE 2	80	57	32	N	AWnChDly
287	SYNTH-LEAD	PERC.CHIFF 1	83	49	16	N	Comp 1
288	SYNTH-LEAD	CHIFF LEAD 2	83	50	16	N	Comp 1
289	SYNTH-LEAD	TECH POLYSYNTH 1	86	52	16	N	Ring Mod
290	SYNTH-LEAD	TECH POLYSYNTH 2	86	54	32	N	LoFI Ref
291	SYNTH-LEAD	RESONANCE LEAD	86	53	16	N	Enha Diy
292	SYNTH-LEAD	FRET LEAD	87	52	16	N	Enha Diy
293	SYNTH-LEAD	SEVENTH SEQ	86	55	16	N	Phaser
294	SYNTH-LEAD	WAH SEQ	86	56	16	N	AWnChDly
295	SYNTH-PAD	FANTASY PAD	88	48	16	N	PhaDly 2
296	SYNTH-PAD	WARM PAD	89	48	32	N	Equalize
297	SYNTH-PAD	POLYSYNTH PAD	90	48	16	N	Cho Trem
298	SYNTH-PAD	SPACE VOICE 1	91	48	16	N	RotRef 1
299	SYNTH-PAD	COSMIC VOICE	91	50	16	N	Rotary 2
300	SYNTH-PAD	BOWED PAD	92	48	16	N	3Tap Dly
301	SYNTH-PAD	METAL PAD 1	93	48	16	N	STDelay
302	SYNTH-PAD	HALO PAD	94	48	16	N	SIPhaser
303	SYNTH-PAD	SWEEP PAD	95	48	32	N	Equalize
304	SYNTH-PAD	MOVIE SOUND	97	48	16	N	FlanDly1
305	SYNTH-PAD	NOISY SAW	90	49	16	N	Lo-Fi
306	SYNTH-PAD	SINE PAD	98	49	16	N	CompDelay
307	SYNTH-PAD	VIBE PAD	96	49	16	N	CompDelay
308	SYNTH-PAD	RAIN PAD	96	48	16	N	Comp 1
309	SYNTH-PAD	CRYSTAL 1	98	48	16	N	PhaDly 2
310	SYNTH-PAD	CRYSTAL 2	98	50	16	N	STDelay
311	SYNTH-PAD	ATMOSPHERE PAD	99	49	16	N	GateRvb1
312	SYNTH-PAD	BRIGHTER	100	49	16	N	Delay
313	SYNTH-PAD	STAR THEME	103	48	16	N	PhaAPan2
314	SYNTH-PAD	NEW FANTASY	88	49	16	N	ChoDly 3
315	SYNTH-PAD	WARM VOX	89	50	16	N	Equalize
316	SYNTH-PAD	FLUTE PAD	89	51	16	N	Equalize
317	SYNTH-PAD	ATTACK POLYSYNTH	90	50	16	N	Equalize
318	SYNTH-PAD	CHIFF CHOIR	91	51	16	N	Cho Flan
319	SYNTH-PAD	STAR VOICE 1	91	52	16	N	DSChoDly
320	SYNTH-PAD	SPACE VOICE 2	91	53	32	N	AWnChDly
321	SYNTH-PAD	SPACE VOICE 2	91	49	16	N	RgChoDly
322	SYNTH-PAD	SPACE CHOIR	91	54	32	N	ChoDly 4
323	SYNTH-PAD	BOTTLE PAD	92	49	16	N	LFO Wah
324	SYNTH-PAD	DEEP BLUE	97	49	32	N	RevHall2
325	SYNTH-PAD	GOBLIN PAD	101	48	16	N	Flanger
326	SYNTH-PAD	POLY SAW	90	51	16	N	ChoDly 3
327	SYNTH-PAD	BOUNCE PAD	94	49	16	N	Dist Cho
328	SYNTH-PAD	SLOW SWEEP	95	49	16	N	RgChoDly
329	SYNTH-PAD	STEEL PAD	99	49	16	N	ChoDly 3
330	SYNTH-PAD	WONDER BELL	98	51	16	N	GateRvb4
331	SYNTH-PAD	SAVANNA	98	52	32	N	RgChoDly

Preset Tones

1	2	3	4	5	6	7	8
457	GM		57	64	32	N	-
458	GM	GM TROMBONE	58	64	32	N	-
459	GM	GM MUTE TRUMPET	59	64	32	N	-
460	GM	GM FRENCH HORN	60	64	16	N	-
461	GM	GM BRASS	61	64	32	N	-
462	GM	GM SYNTH-BRASS 1	62	64	32	N	-
463	GM	GM SYNTH-BRASS 2	63	64	16	N	-
464	GM	GM SOPRANO SAX	64	64	32	N	-
465	GM	GM ALTO SAX	65	64	32	N	-
466	GM	GM TENOR SAX	66	64	32	N	-
467	GM	GM BARTONE SAX	67	64	32	N	-
468	GM	GM OBOE	68	64	32	N	-
469	GM	GM ENGLISH HORN	69	64	32	N	-
470	GM	GM BASSOON	70	64	32	N	-
471	GM	GM CLARINET	71	64	32	N	-
472	GM	GM PICCOLO	72	64	32	N	-
473	GM	GM FLUTE	73	64	32	N	-
474	GM	GM RECORDER	74	64	32	N	-
475	GM	GM PAN FLUTE	75	64	32	N	-
476	GM	GM BOTTLE BLOW	76	64	32	N	-
477	GM	GM SHAKUHACHI	77	64	16	N	-
478	GM	GM WHISTLE	78	64	32	N	-
479	GM	GM OCARINA	79	64	32	N	-
480	GM	GM SQUARE LEAD	80	64	16	N	-
481	GM	GM SAWTOOTH LEAD	81	64	16	N	-
482	GM	GM CALLIOPE	82	64	16	N	-
483	GM	GM CHIFF LEAD	83	64	16	N	-
484	GM	GM CHARANG	84	64	16	N	-
485	GM	GM VOICE LEAD	85	64	16	N	-
486	GM	GM FIFTH LEAD	86	64	16	N	-
487	GM	GM BASS-LEAD	87	64	16	N	-
488	GM	GM FANTASY	88	64	16	N	-
489	GM	GM WARM PAD	89	64	32	N	-
490	GM	GM POLY SYNTH	90	64	16	N	-
491	GM	GM SPACE CHOIR	91	64	16	N	-
492	GM	GM BOWED GLASS	92	64	16	N	-
493	GM	GM METAL PAD	93	64	16	N	-
494	GM	GM HALO PAD	94	64	16	N	-
495	GM	GM SWEEP PAD	95	64	32	N	-
496	GM	GM RAIN DROP	96	64	16	N	-
497	GM	GM SOUND TRACK	97	64	16	N	-
498	GM	GM CRYSTAL	98	64	16	N	-
499	GM	GM ATMOSPHERE	99	64	16	N	-
500	GM	GM BRIGHTNESS	100	64	16	N	-
501	GM	GM GOBLINS	101	64	16	N	-
502	GM	GM ECHOES	102	64	32	N	-
503	GM	GM SF	103	64	16	N	-
504	GM	GM SITAR	104	64	16	N	-
505	GM	GM BANJO	105	64	32	N	-
506	GM	GM SHAMISEN	106	64	32	N	-
507	GM	GM KOTO	107	64	32	N	-
508	GM	GM THUMB PIANO	108	64	32	N	-
509	GM	GM BAGPIPE	109	64	16	N	-
510	GM	GM FIDDLE	110	64	32	N	-
511	GM	GM SHANA	111	64	32	N	-
512	GM	GM TINKLE BELL	112	64	32	N	-
513	GM	GM AGOGO	113	64	32	N	-
514	GM	GM STEEL DRUMS	114	64	16	N	-
515	GM	GM WOOD BLOCK	115	64	32	N	-

1	2	3	4	5	6	7	8
400	GM	GM PIANO 1	0	64	32	N	-
401	GM	GM PIANO 2	1	64	32	N	-
402	GM	GM PIANO 3	2	64	32	N	-
403	GM	GM HONKY-TONK	3	64	16	N	-
404	GM	GM E.PIANO 1	4	64	32	N	-
405	GM	GM E.PIANO 2	5	64	16	N	-
406	GM	GM HARPSICHOARD	6	64	32	N	-
407	GM	GM CLAVI	7	64	32	N	-
408	GM	GM CELESTA	8	64	32	N	-
409	GM	GM GLOCKENSPIEL	9	64	32	N	-
410	GM	GM MUSIC BOX	10	64	16	N	-
411	GM	GM VIBRAPHONE	11	64	32	N	-
412	GM	GM MARIMBA	12	64	32	N	-
413	GM	GM XYLOPHONE	13	64	32	N	-
414	GM	GM TUBULAR BELL	14	64	32	N	-
415	GM	GM DULCIMER	15	64	16	N	-
416	GM	GM ORGAN 1	16	64	32	N	-
417	GM	GM ORGAN 2	17	64	16	N	-
418	GM	GM ORGAN 3	18	64	16	N	-
419	GM	GM PIPE ORGAN	19	64	16	N	-
420	GM	GM REED ORGAN	20	64	32	N	-
421	GM	GM ACCORDION	21	64	16	N	-
422	GM	GM HARMONICA	22	64	32	N	-
423	GM	GM BANDONEON	23	64	16	N	-
424	GM	GM NYLON STR.GUITAR	24	64	32	N	-
425	GM	GM STEEL STR.GUITAR	25	64	32	N	-
426	GM	GM JAZZ GUITAR	26	64	32	N	-
427	GM	GM CLEAN GUITAR	27	64	32	N	-
428	GM	GM MUTE GUITAR	28	64	32	N	-
429	GM	GM OVERDRIVE GT	29	64	16	N	-
430	GM	GM DISTORTION GT	30	64	16	N	-
431	GM	GM GT HARMONICS	31	64	32	N	-
432	GM	GM ACOUSTIC BASS	32	64	32	N	-
433	GM	GM FINGERED BASS	33	64	32	N	-
434	GM	GM PICKED BASS	34	64	32	N	-
435	GM	GM FRETLESS BASS	35	64	32	N	-
436	GM	GM SLAP BASS 1	36	64	32	N	-
437	GM	GM SLAP BASS 2	37	64	32	N	-
438	GM	GM SYNTH-BASS 1	38	64	16	N	-
439	GM	GM SYNTH-BASS 2	39	64	32	N	-
440	GM	GM VIOLIN	40	64	32	N	-
441	GM	GM VIOLA	41	64	32	N	-
442	GM	GM CELLO	42	64	32	N	-
443	GM	GM CONTRABASS	43	64	32	N	-
444	GM	GM TREMOLO STRINGS	44	64	32	N	-
445	GM	GM PIZZICATO	45	64	32	N	-
446	GM	GM HARP	46	64	32	N	-
447	GM	GM TIMPANI	47	64	32	N	-
448	GM	GM STRINGS 1	48	64	32	N	-
449	GM	GM STRINGS 2	49	64	32	N	-
450	GM	GM SYNTH-STRINGS 1	50	64	32	N	-
451	GM	GM SYNTH-STRINGS 2	51	64	32	N	-
452	GM	GM CHOIR AAHS	52	64	32	N	-
453	GM	GM VOICE DOO	53	64	32	N	-
454	GM	GM SYNTH-VOICE	54	64	32	N	-
455	GM	GM ORCHESTRA HIT	55	64	16	N	-
456	GM	GM TRUMPET	56	64	32	N	-

1	2	3	4	5	6	7	8
575	VARIOUS	BRASS+TRUMPET	61	68	16	N	-
576	VARIOUS	BRASS+TROMBONE	61	65	16	N	-
577	VARIOUS	SYNTH-BRASS VAR.	62	65	32	N	-
578	VARIOUS	OCTAVE SYNTH-BRASS	62	66	16	N	-
579	VARIOUS	SYNTH-BRASS SFZ	63	65	16	N	-
581	VARIOUS	BREATHY ALTO SAX VAR.	65	69	16	N	-
582	VARIOUS	BREATHY TENOR SAX VAR.	66	69	16	N	-
583	VARIOUS	MELLOW ALTO SAX	65	65	16	N	-
583	VARIOUS	MELLOW TENOR SAX	66	65	16	N	-
584	VARIOUS	TRIANGLE WAVE	80	66	32	N	-
585	VARIOUS	SQUARE WAVE 3	80	74	32	N	-
586	VARIOUS	SAW WAVE	81	65	32	N	-
587	VARIOUS	SAW+SQR	81	66	16	N	-
588	VARIOUS	SEQ SAW 2	81	68	16	N	-
589	VARIOUS	PERC CHIFF 2	83	67	16	N	-
590	VARIOUS	GT SYNTH-LEAD 2	84	68	16	N	-
591	VARIOUS	VOX LEAD 2	85	65	16	N	-
592	VARIOUS	BASS LEAD 3	87	65	16	N	-
593	VARIOUS	SINE SYNTH	89	65	16	N	-
594	VARIOUS	SOPRANO PAD	89	68	16	N	-
595	VARIOUS	GLASS PAD	92	66	16	N	-
596	VARIOUS	METAL PAD 2	93	65	16	N	-
597	VARIOUS	FAST SWEEP	95	66	16	N	-
598	VARIOUS	WOOD PAD	96	66	16	N	-
599	VARIOUS	SYNTH-MALLET	98	65	16	N	-

Drum Sets

1	2	3	4	5
600	DRUM SET	STANDARD SET 1	0	120
601	DRUM SET	STANDARD SET 2	1	120
602	DRUM SET	STANDARD SET 3	2	120
603	DRUM SET	STANDARD SET 4	3	120
604	DRUM SET	ROOM SET	8	120
605	DRUM SET	POWER SET	16	120
606	DRUM SET	ELECTRONIC SET	24	120
607	DRUM SET	SYNTH SET 1	25	120
608	DRUM SET	SYNTH SET 2	30	120
609	DRUM SET	JAZZ SET	32	120
610	DRUM SET	BRUSH SET	40	120
611	DRUM SET	ORCHESTRA SET	48	120
612	DRUM SET	HIP-HOP SET 1	64	120
613	DRUM SET	HIP-HOP SET 2	65	120
614	DRUM SET	TECHNO SET 1	66	120
615	DRUM SET	TECHNO SET 2	67	120
616	DRUM SET	DANCE SET 1	68	120
617	DRUM SET	DANCE SET 2	69	120

1	2	3	4	5	6	7	8
516	GM	GM TAIKO	116	64	32	N	-
517	GM	GM MELODIC TOM	117	64	32	N	-
518	GM	GM SYNTH-DRUM	118	64	32	N	-
519	GM	GM REVERSE CYMBAL	119	64	32	N	-
520	GM	GM GT FRET NOISE	120	64	32	N	-
521	GM	GM BREATH NOISE	121	64	32	N	-
522	GM	GM SEASHORE	122	64	16	N	-
523	GM	GM BIRD	123	64	16	N	-
524	GM	GM TELEPHONE	124	64	32	N	-
525	GM	GM HELICOPTER	125	64	32	N	-
526	GM	GM APPLAUSE	126	64	16	N	-
527	GM	GM GUNSHOT	127	64	32	N	-
528	VARIOUS	TECHNO PIANO	1	70	32	N	-
529	VARIOUS	MODERN E.G.PIANO WIDE	2	65	32	N	-
530	VARIOUS	HONKY-TONK 2	3	65	16	N	-
531	VARIOUS	DYNO ELEC.PIANO VAR.	4	65	32	N	-
532	VARIOUS	60'S ELEC.PIANO VAR.	4	68	32	N	-
533	VARIOUS	ELEC.PIANO 3	4	66	16	N	-
534	VARIOUS	MODERN EP+E.G.PIANO	5	66	16	N	-
535	VARIOUS	MODERN EP VAR.	5	68	16	N	-
536	VARIOUS	HARPSICHOORD VAR.	6	66	32	N	-
537	VARIOUS	PULSE CLAVI VAR.	7	65	32	N	-
538	VARIOUS	VIBRAPHONE VAR.	11	65	32	N	-
539	VARIOUS	MARIMBA VAR.	12	65	32	N	-
540	VARIOUS	THEMOLO ORGAN VAR.	16	65	32	N	-
541	VARIOUS	70'S ORGAN VAR.	17	65	32	N	-
542	VARIOUS	CHURCH ORGAN 3	19	66	16	N	-
543	VARIOUS	PUFF ORGAN	20	65	16	N	-
544	VARIOUS	NYLON GUITAR RELEASE	24	66	16	N	-
545	VARIOUS	ACOUSTIC GUITAR VAR.	25	69	32	N	-
546	VARIOUS	PEDAL STEEL	26	65	16	N	-
547	VARIOUS	DETUNE CLEAN GT	27	65	16	N	-
548	VARIOUS	PLAIN ELEC.GUITAR REAR	27	66	32	N	-
549	VARIOUS	PLAIN ELEC.GUITAR FRONT	27	67	32	N	-
550	VARIOUS	FEEDBACK GUITAR VAR.	30	65	16	N	-
551	VARIOUS	GUITAR FEEDBACK	31	65	32	N	-
552	VARIOUS	ACOUSTIC BASS 1 VAR.	32	67	32	N	-
553	VARIOUS	FINGERED BASS 1 VAR.	33	67	32	N	-
554	VARIOUS	SAW SYNTH-BASS 3	38	67	16	N	-
555	VARIOUS	SAW SYNTH-BASS 4	38	73	16	N	-
556	VARIOUS	RESO.SAW BASS 3	38	72	16	N	-
557	VARIOUS	ORGAN BASS 2	38	74	16	N	-
558	VARIOUS	SQR SYNTH-BASS 2	39	65	16	N	-
559	VARIOUS	SQR SYNTH-BASS 3	39	73	16	N	-
560	VARIOUS	ATTACK SQR BASS	39	74	16	N	-
561	VARIOUS	OCTAVE STRINGS	48	66	16	N	-
562	VARIOUS	SYNTH-STRINGS 2	50	65	16	N	-
563	VARIOUS	CHOIR+UJH	52	65	16	N	-
564	VARIOUS	SCAT VOICE 4	53	71	16	N	-
565	VARIOUS	SCAT VOICE 5	53	72	16	N	-
566	VARIOUS	SYNTH-VOICE 3	54	68	16	N	-
567	VARIOUS	SEG VOX	54	66	32	N	-
568	VARIOUS	BASS HIT VAR.	55	65	16	N	-
569	VARIOUS	POP HIT 3	55	66	16	N	-
570	VARIOUS	ORCHESTRA HIT 2	55	67	16	N	-
571	VARIOUS	TIMPANI HIT	55	73	16	N	-
572	VARIOUS	TRUMPET 3	56	65	32	N	-
573	VARIOUS	MUTE TRUMPET VAR.	59	65	32	N	-
574	VARIOUS	MELLOW FRENCH HORN	60	65	16	N	-

User Tones

1	2	3	4	5
757	USER TONE	TREMOLO ORGAN	57	94
758	USER TONE	JAZZ DRAWBAR	58	94
759	USER TONE	ROCK ORGAN	59	94
760	USER TONE	OVD ROTARY ORGAN	60	94
761	USER TONE	ROTARY ELEC ORGAN	61	94
762	USER TONE	CHURCH ORGAN 1	62	94
763	USER TONE	CHAPEL ORGAN	63	94
764	USER TONE	ACCORDION	64	94
765	USER TONE	BANDONEON	65	94
766	USER TONE	HARMONICA	66	94
767	USER TONE	DRAWBAR ORGAN 1	67	94
768	USER TONE	DRAWBAR ORGAN 2	68	94
769	USER TONE	ELEC ORGAN	69	94
770	USER TONE	PERC. ORGAN 1	70	94
771	USER TONE	PERC. ORGAN 2	71	94
772	USER TONE	JAZZ ORGAN	72	94
773	USER TONE	OVD ROCK ORGAN	73	94
774	USER TONE	TAPE ORGAN	74	94
775	USER TONE	CHURCH ORGAN 2	75	94
776	USER TONE	OCTAVE ACCORDION	76	94
777	USER TONE	NEO BANDONEON	77	94
778	USER TONE	SLOW HARMONICA	78	94
779	USER TONE	WAH HARMONICA	79	94
780	USER TONE	PURE ACOUSTIC GUITAR	80	94
781	USER TONE	NYLON STR GUITAR	81	94
782	USER TONE	STEEL STR. GUITAR	82	94
783	USER TONE	JAZZ GUITAR	83	94
784	USER TONE	CHORUS CLEAN GUITAR	84	94
785	USER TONE	ROTARY GUITAR	85	94
786	USER TONE	CRUNCH ELEC. GUITAR	86	94
787	USER TONE	OVD FRONT GUITAR	87	94
788	USER TONE	FEEDBACK DIST. GT	88	94
789	USER TONE	MUTE DIST GUITAR	89	94
790	USER TONE	MELLOW NYLON GUITAR	90	94
791	USER TONE	12 STRING GUITAR	91	94
792	USER TONE	BRIGHT ACOUSTIC GUITAR	92	94
793	USER TONE	CHORUS STEEL GUITAR	93	94
794	USER TONE	UKULELE	94	94
795	USER TONE	BANJO	95	94
796	USER TONE	OCTAVE JAZZ GUITAR	96	94
797	USER TONE	CHORUS JAZZ GUITAR	97	94
798	USER TONE	CLEAN GUITAR	98	94
799	USER TONE	ELEC. GUITAR FRONT	99	94

1	2	3	4	5
700	USER TONE	STEREO GRAND PIANO	0	94
701	USER TONE	STEREO MELLOW PIANO	1	94
702	USER TONE	STEREO BRIGHT PIANO	2	94
703	USER TONE	GRAND PIANO	3	94
704	USER TONE	ROCK PIANO	4	94
705	USER TONE	MODERN PIANO	5	94
706	USER TONE	DANCE PIANO	6	94
707	USER TONE	MELLOW PIANO	7	94
708	USER TONE	BRIGHT PIANO	8	94
709	USER TONE	SYNTH-STR PIANO	9	94
710	USER TONE	STRINGS PIANO	10	94
711	USER TONE	VOICE PIANO	11	94
712	USER TONE	ELEC GRAND PIANO	12	94
713	USER TONE	HARPSICHORD	13	94
714	USER TONE	GRAND PIANO WIDE	14	94
715	USER TONE	AMBIENT PIANO	15	94
716	USER TONE	1 OCTAVE PIANO	16	94
717	USER TONE	2 OCTAVE PIANO	17	94
718	USER TONE	MODERN E.G. PIANO	18	94
719	USER TONE	COMP. PIANO	19	94
720	USER TONE	HONKY-TONK 1	20	94
721	USER TONE	BRIGHT HARPSICHORD	21	94
722	USER TONE	COUPLED HARPSICHORD	22	94
723	USER TONE	ELEC. PIANO 1	23	94
724	USER TONE	ELEC. PIANO 2	24	94
725	USER TONE	FM ELEC. PIANO	25	94
726	USER TONE	DYNO ELEC. PIANO	26	94
727	USER TONE	60'S ELEC. PIANO	27	94
728	USER TONE	MELLOW E. PIANO	28	94
729	USER TONE	POP ELEC. PIANO	29	94
730	USER TONE	TREMOLO E. PIANO	30	94
731	USER TONE	SOFT E. PIANO	31	94
732	USER TONE	GLASS E. PIANO	32	94
733	USER TONE	SYNTH-STR E. PIANO 1	33	94
734	USER TONE	CLAVI	34	94
735	USER TONE	AUTO WAH E. PIANO	35	94
736	USER TONE	PHASER E. PIANO	36	94
737	USER TONE	MODERN E. PIANO	37	94
738	USER TONE	WARM ELEC. PIANO	38	94
739	USER TONE	ELEC. PIANO PAD	39	94
740	USER TONE	SYNTH-STR E. PIANO 2	40	94
741	USER TONE	STRINGS E. PIANO	41	94
742	USER TONE	RESONANCE CLAVI	42	94
743	USER TONE	PULSE CLAVI	43	94
744	USER TONE	LA CLAVI	44	94
745	USER TONE	TREMOLO VIBRAPHONE	45	94
746	USER TONE	MARIMBA	46	94
747	USER TONE	GLOCKENSPIEL	47	94
748	USER TONE	CELESTA	48	94
749	USER TONE	VIBRAPHONE	49	94
750	USER TONE	PHASER MARIMBA	50	94
751	USER TONE	DELAY GLOCKENSPIEL	51	94
752	USER TONE	ROTARY CELESTA	52	94
753	USER TONE	ROTARY DRAWBAR	53	94
754	USER TONE	ROTARY PERC. ORGAN 1	54	94
755	USER TONE	ROTARY PERC. ORGAN 2	55	94
756	USER TONE	70'S ORGAN	56	94

Tone with Waves

1	2	3	4	5
800	USER TONE with WAVE	PIANO EX	0	88
801	USER TONE with WAVE	CZ SWEEP BASS	1	88
802	USER TONE with WAVE	CZ LEAD 1	2	88
803	USER TONE with WAVE	CZ SYNTH 1	3	88
804	USER TONE with WAVE	VOICE BASS	4	88
805	USER TONE with WAVE	NO DATA	5	88
806	USER TONE with WAVE	NO DATA	6	88
807	USER TONE with WAVE	NO DATA	7	88
808	USER TONE with WAVE	NO DATA	8	88
809	USER TONE with WAVE	NO DATA	9	88
810	USER TONE with WAVE	NO DATA	10	88
811	USER TONE with WAVE	NO DATA	11	88
812	USER TONE with WAVE	NO DATA	12	88
813	USER TONE with WAVE	NO DATA	13	88
814	USER TONE with WAVE	NO DATA	14	88
815	USER TONE with WAVE	NO DATA	15	88
816	USER TONE with WAVE	NO DATA	16	88
817	USER TONE with WAVE	NO DATA	17	88
818	USER TONE with WAVE	NO DATA	18	88
819	USER TONE with WAVE	NO DATA	19	88

User Drum Sets with Waves

1	2	3	4	5
900	USER DRUM SET with WAVE	POWER ROOM SET	0	125
901	USER DRUM SET with WAVE	NO DATA	1	125
902	USER DRUM SET with WAVE	NO DATA	2	125
903	USER DRUM SET with WAVE	NO DATA	3	125

Drawbar Organ Preset Tones

1	2	3	4	5	6	7	8
0	DRAWBAR	DRAWBAR ORGAN 1	0	96	10	N	Rotary
1	DRAWBAR	JAZZ ORGAN 1	1	96	10	N	Rotary
2	DRAWBAR	FULL DRAWBAR	2	96	16	N	Rotary
3	DRAWBAR	PERC. ORGAN 1	3	96	16	N	Rotary
4	DRAWBAR	16'+1' ORGAN	4	96	16	N	Rotary
5	DRAWBAR	SOUL ORGAN 1	5	96	10	N	Rotary
6	DRAWBAR	OVERDRIVE ORGAN 1	6	96	16	N	OvdRotry
7	DRAWBAR	DRAWBAR ORGAN 2	7	96	16	N	Rotary
8	DRAWBAR	BLOCK ORGAN 1	8	96	16	N	OvdRotry
9	DRAWBAR	THEATER ORGAN 1	9	96	16	N	Rotary
10	DRAWBAR	JAZZ ORGAN 2	10	96	10	N	Rotary
11	DRAWBAR	SOUL ORGAN 2	11	96	16	N	Rotary
12	DRAWBAR	GOSPEL ORGAN 1	12	96	16	N	Rotary
13	DRAWBAR	CHORUS ORGAN 1	13	96	16	N	Rotary
14	DRAWBAR	OVERDRIVE ORGAN 2	14	96	10	N	OvdRotry
15	DRAWBAR	BLOCK ORGAN 2	15	96	16	N	Rotary
16	DRAWBAR	DRAWBAR ORGAN 3	16	96	16	N	Rotary
17	DRAWBAR	PERC. ORGAN 2	17	96	16	N	Rotary
18	DRAWBAR	THEATER ORGAN 2	18	96	16	N	Rotary
19	DRAWBAR	GOSPEL ORGAN 2	19	96	16	N	Rotary
20	DRAWBAR	EVEN ORGAN	20	96	16	N	Rotary
21	DRAWBAR	FLUTE ORGAN 1	21	96	16	N	Rotary
22	DRAWBAR	CHORUS ORGAN 2	22	96	16	N	Rotary
23	DRAWBAR	OVERDRIVE ORGAN 3	23	96	16	N	Rotary
24	DRAWBAR	16' ORGAN	24	96	16	N	Rotary
25	DRAWBAR	SOUL ORGAN 3	25	96	16	N	Rotary
26	DRAWBAR	PERC. ORGAN 3	26	96	16	N	Rotary
27	DRAWBAR	DRAWBAR ORGAN 4	27	96	16	N	Rotary
28	DRAWBAR	PERC. ORGAN 4	28	96	10	N	Rotary
29	DRAWBAR	ODD ORGAN	29	96	16	N	Rotary
30	DRAWBAR	REED ORGAN 1	30	96	16	N	Rotary
31	DRAWBAR	BLOCK ORGAN 3	31	96	10	N	Rotary
32	DRAWBAR	OVERDRIVE ORGAN 4	32	96	10	N	OvdRotry
33	DRAWBAR	DRAWBAR ORGAN 5	33	96	10	N	Rotary
34	DRAWBAR	GOSPEL ORGAN 3	34	96	16	N	Rotary
35	DRAWBAR	8' + 4' ORGAN	35	96	32	N	Rotary
36	DRAWBAR	BLOCK ORGAN 4	36	96	32	N	Rotary
37	DRAWBAR	REED ORGAN 2	37	96	16	N	Rotary
38	DRAWBAR	PURE ORGAN 1	38	96	32	N	Rotary
39	DRAWBAR	DRAWBAR ORGAN 6	39	96	10	N	Rotary
40	DRAWBAR	DELAY ORGAN 1	40	96	10	N	Rotary
41	DRAWBAR	DEEP CHORUS ORGAN	41	96	32	N	SXDIY 2
42	DRAWBAR	TREMOLO ORGAN	42	96	16	N	Cho.Trem
43	DRAWBAR	DELAY ORGAN 2	43	96	16	N	Cho.Diy6
44	DRAWBAR	LFO WAH ORGAN	44	96	16	N	LWfChD12
45	DRAWBAR	DIST. ORGAN LEAD	45	96	16	N	MetalDiy
46	DRAWBAR	RING ORGAN	46	96	16	N	RingMod2
47	DRAWBAR	MAD ROTARY ORGAN	47	96	10	N	RgChDiy2
48	DRAWBAR	OLD ORGAN	48	96	16	N	LoFRef2
49	DRAWBAR	DIST. RING ORGAN	49	96	10	N	DistRing

Drawbar Organ User Tones

1	2	3	4	5
100	USER DRAWBAR DRAWBAR ORGAN 1		0	104
101	USER DRAWBAR JAZZ ORGAN 1		1	104
102	USER DRAWBAR FULL DRAWBAR		2	104
103	USER DRAWBAR PERC. ORGAN 1		3	104
104	USER DRAWBAR 16+1' ORGAN		4	104
105	USER DRAWBAR SOUL ORGAN 1		5	104
106	USER DRAWBAR OVERDRIVE ORGAN 1		6	104
107	USER DRAWBAR DRAWBAR ORGAN 2		7	104
108	USER DRAWBAR BLOCK ORGAN 1		8	104
109	USER DRAWBAR THEATER ORGAN 1		9	104
110	USER DRAWBAR JAZZ ORGAN 2		10	104
111	USER DRAWBAR SOUL ORGAN 2		11	104
112	USER DRAWBAR GOSPEL ORGAN 1		12	104
113	USER DRAWBAR CHORUS ORGAN 1		13	104
114	USER DRAWBAR OVERDRIVE ORGAN 2		14	104
115	USER DRAWBAR BLOCK ORGAN 2		15	104
116	USER DRAWBAR DRAWBAR ORGAN 3		16	104
117	USER DRAWBAR PERC. ORGAN 2		17	104
118	USER DRAWBAR THEATER ORGAN 2		18	104
119	USER DRAWBAR GOSPEL ORGAN 2		19	104
120	USER DRAWBAR EVEN ORGAN		20	104
121	USER DRAWBAR FLUTE ORGAN 1		21	104
122	USER DRAWBAR CHORUS ORGAN 2		22	104
123	USER DRAWBAR OVERDRIVE ORGAN 3		23	104
124	USER DRAWBAR 16' ORGAN		24	104
125	USER DRAWBAR SOUL ORGAN 3		25	104
126	USER DRAWBAR PERC. ORGAN 3		26	104
127	USER DRAWBAR DRAWBAR ORGAN 4		27	104
128	USER DRAWBAR PERC. ORGAN 4		28	104
129	USER DRAWBAR ODD ORGAN		29	104
130	USER DRAWBAR REED ORGAN 1		30	104
131	USER DRAWBAR BLOCK ORGAN 3		31	104
132	USER DRAWBAR OVERDRIVE ORGAN 4		32	104

1	2	3	4	5
133	USER DRAWBAR DRAWBAR ORGAN 5		33	104
134	USER DRAWBAR GOSPEL ORGAN 3		34	104
135	USER DRAWBAR 8' + 4' ORGAN		35	104
136	USER DRAWBAR BLOCK ORGAN 4		36	104
137	USER DRAWBAR REED ORGAN 2		37	104
138	USER DRAWBAR PURE ORGAN 1		38	104
139	USER DRAWBAR DRAWBAR ORGAN 6		39	104
140	USER DRAWBAR DELAY ORGAN 1		40	104
141	USER DRAWBAR DEEP CHORUS ORGAN		41	104
142	USER DRAWBAR TREMOLO ORGAN		42	104
143	USER DRAWBAR DELAY ORGAN 2		43	104
144	USER DRAWBAR LFO WAH ORGAN		44	104
145	USER DRAWBAR DIST. ORGAN LEAD		45	104
146	USER DRAWBAR RING ORGAN		46	104
147	USER DRAWBAR MAD ROTARY ORGAN		47	104
148	USER DRAWBAR OLD ORGAN		48	104
149	USER DRAWBAR DIST. RING ORGAN		49	104
150	USER DRAWBAR DRAWBAR ORGAN 1		50	104
151	USER DRAWBAR JAZZ ORGAN 1		51	104
152	USER DRAWBAR FULL DRAWBAR		52	104
153	USER DRAWBAR PERC. ORGAN 1		53	104
154	USER DRAWBAR 16+1' ORGAN		54	104
155	USER DRAWBAR SOUL ORGAN 1		55	104
156	USER DRAWBAR OVERDRIVE ORGAN 1		56	104
157	USER DRAWBAR DRAWBAR ORGAN 2		57	104
158	USER DRAWBAR BLOCK ORGAN 1		58	104
159	USER DRAWBAR THEATER ORGAN 1		59	104
160	USER DRAWBAR JAZZ ORGAN 2		60	104
161	USER DRAWBAR SOUL ORGAN 2		61	104
162	USER DRAWBAR GOSPEL ORGAN 1		62	104
163	USER DRAWBAR CHORUS ORGAN 1		63	104
164	USER DRAWBAR OVERDRIVE ORGAN 2		64	104
165	USER DRAWBAR BLOCK ORGAN 2		65	104

1	2	3	4	5
166	USER DRAWBAR DRAWBAR ORGAN 3		66	104
167	USER DRAWBAR PERC. ORGAN 2		67	104
168	USER DRAWBAR THEATER ORGAN 2		68	104
169	USER DRAWBAR GOSPEL ORGAN 2		69	104
170	USER DRAWBAR EVEN ORGAN		70	104
171	USER DRAWBAR FLUTE ORGAN 1		71	104
172	USER DRAWBAR CHORUS ORGAN 2		72	104
173	USER DRAWBAR OVERDRIVE ORGAN 3		73	104
174	USER DRAWBAR 16' ORGAN		74	104
175	USER DRAWBAR SOUL ORGAN 3		75	104
176	USER DRAWBAR PERC. ORGAN 3		76	104
177	USER DRAWBAR DRAWBAR ORGAN 4		77	104
178	USER DRAWBAR PERC. ORGAN 4		78	104
179	USER DRAWBAR ODD ORGAN		79	104
180	USER DRAWBAR REED ORGAN 1		80	104
181	USER DRAWBAR BLOCK ORGAN 3		81	104
182	USER DRAWBAR OVERDRIVE ORGAN 4		82	104
183	USER DRAWBAR DRAWBAR ORGAN 5		83	104
184	USER DRAWBAR GOSPEL ORGAN 3		84	104
185	USER DRAWBAR 8' + 4' ORGAN		85	104
186	USER DRAWBAR BLOCK ORGAN 4		86	104
187	USER DRAWBAR REED ORGAN 2		87	104
188	USER DRAWBAR PURE ORGAN 1		88	104
189	USER DRAWBAR DRAWBAR ORGAN 6		89	104
190	USER DRAWBAR DELAY ORGAN 1		90	104
191	USER DRAWBAR DEEP CHORUS ORGAN		91	104
192	USER DRAWBAR TREMOLO ORGAN		92	104
193	USER DRAWBAR DELAY ORGAN 2		93	104
194	USER DRAWBAR LFO WAH ORGAN		94	104
195	USER DRAWBAR DIST. ORGAN LEAD		95	104
196	USER DRAWBAR RING ORGAN		96	104
197	USER DRAWBAR MAD ROTARY ORGAN		97	104
198	USER DRAWBAR OLD ORGAN		98	104
199	USER DRAWBAR DIST. RING ORGAN		99	104

NOTE

Range

Symbol	Meaning
N	Normal
-1	1 Octave Down
+1	1 Octave Up

- The above list shows the initial factory default configuration. The tone group tone numbers indicated below will change from those shown in this list if you save original tones to keyboard memory (page E-46).
 - User Tones (Tone Numbers 700 through 799)*1
 - User Tones with Waves (Tone Numbers 800 through 819)*2
 - User Drum Sets with Waves (Tone Numbers 900 through 903)*3
 - Drawbar Organ User Tones (Tone Numbers 100 through 199)*4
- *1 The initial factory default is Advanced Tones 000 through 099. System reset (page E-73) returns to factory defaults.
 *2 The initial factory default is preset Tone with Wave data for tone numbers 800 through 804. System reset clears all stored data.
 *3 The initial factory default is preset Drum Set with Wave data for tone number 900. System reset clears all stored data.
 *4 The initial factory default is two sets of the same tones assigned to drawbar organ tone numbers 000 through 049. System reset returns to factory defaults.
 • The CD-ROM that comes bundled with the keyboard can be used to return all tones to the initial factory defaults shown in this list. See "Returning the keyboard to its initial factory defaults" on page E-80 for details.

Drum Assignment List

“ ← ” indicates the same sound as STANDARD SET 1.

Key/ Note number	DRUMS SET LIST									
	PC0: STANDARD SET 1	PC1: STANDARD SET 2	PC2: STANDARD SET 3	PC3: STANDARD SET 4	PC4: STANDARD SET 5	PC8: ROOM SET	PC16: POWER SET	PC24: ELECTRONIC SET	PC25: SYNTH SET 1	PC30: SYNTH SET 2
C-1 0	LOW TOM 2a									
C#-1 1	LOW TOM 2b									
D-1 2	LOW TOM 1a									
E-1 4	LOW TOM 1b									
F-1 5	MID TOM 2a									
F#-1 6	MID TOM 2b									
G-1 7	MID TOM 1a									
A-1 9	MID TOM 1b									
A#-1 10	HIGH TOM 2a									
B-1 11	HIGH TOM 2b									
	HIGH TOM 1a									
	HIGH TOM 1b									
C0 12	CRASH CYMBAL 1a									
C0 14	CRASH CYMBAL 1b									
D0 14	CRASH CYMBAL 1c									
E0 16	CRASH CYMBAL 2a									
E0 16	CRASH CYMBAL 2b									
F0 17	CRASH CYMBAL 2c									
G0 19	RIDE CYMBAL 1a									
G0 19	RIDE CYMBAL 1b									
A0 21	RIDE CYMBAL 1c									
A0 21	RIDE CYMBAL 2a									
B0 23	RIDE CYMBAL 2b									
B0 23	RIDE CYMBAL 2c									
C1 24										
C#1 25										
D1 26	HIGH Q									
E1 28	SLAP									
F1 29	SCRATCH PUSH									
F1 29	SCRATCH PULL									
G1 31	STICKS									
A1 33	SQUARE CLICK									
A1 33	METRONOME CLICK									
B1 35	METRONOME BELL									
C2 36	STANDARD1 KICK 2	STANDARD2 KICK 2	STANDARD3 KICK 2	STANDARD4 KICK 2	STANDARDS KICK 2	ROOM KICK 2	POWER KICK 2	ELEC KICK 2	SYNTH 1 KICK 2	SYNTH 2 KICK 2
C2 36	STANDARD1 KICK 1	STANDARD2 KICK 1	STANDARD3 KICK 1	STANDARD4 KICK 1	STANDARDS KICK 1	ROOM KICK 1	POWER KICK 1	ELEC KICK 1	SYNTH 1 KICK 1	SYNTH 2 KICK 1
C2 36	SIDE STICK								SYNTH 1 RIM SHOT	
D2 39	STANDARD1 SNARE 1	STANDARD2 SNARE 1	STANDARD3 SNARE 1	STANDARD4 SNARE 1	STANDARDS SNARE 1	ROOM SNARE 1	POWER SNARE 1	ELEC SNARE 1	SYNTH 1 SNARE 1	SYNTH 2 SNARE 1
E2 40	HAND CLAP 1								SYNTH HAND CLAP	
F2 42	STANDARD1 SNARE 2	STANDARD2 SNARE 2	STANDARD3 SNARE 2	STANDARD4 SNARE 2	STANDARDS SNARE 2	ROOM SNARE 2	POWER SNARE 2	ELEC SNARE 2	SYNTH 1 SNARE 2	SYNTH 2 SNARE 2
F2 42	LOW TOM 2					ROOM LOW TOM 2	POWER LOW TOM 2	ELEC LOW TOM 2	SYNTH 1 LOW TOM 2	SYNTH 2 LOW TOM 2
G2 43	CLOSED HI-HAT								SYNTH 1 OHH	SYNTH 2 OHH
G2 43	LOW TOM 1					ROOM LOW TOM 1	POWER LOW TOM 1	ELEC LOW TOM 1	SYNTH 1 LOW TOM 1	SYNTH 2 LOW TOM 1
A2 44	PEDAL HI-HAT								SYNTH 1 PHH	SYNTH 2 PHH
A2 45	MID TOM 2					ROOM MID TOM 2	POWER MID TOM 2	ELEC MID TOM 2	SYNTH 1 MID TOM 2	SYNTH 2 MID TOM 2
B2 47	OPEN HI-HAT								SYNTH 1 OHH	SYNTH 2 OHH
B2 47	MID TOM 1					ROOM MID TOM 1	POWER MID TOM 1	ELEC MID TOM 1	SYNTH 1 MID TOM 1	SYNTH 2 MID TOM 1
B2 47	HIGH TOM 2					ROOM HI TOM 2	POWER HI TOM 2	ELEC HI TOM 2	SYNTH 1 HI TOM 2	SYNTH 2 HI TOM 2
C3 48	CRASH CYMBAL 1								SYNTH 1 CYMBAL	SYNTH 2 CYMBAL 1
D3 50	HIGH TOM 1					ROOM HI TOM 1	POWER HI TOM 1	ELEC HI TOM 1	SYNTH 1 HI TOM 1	SYNTH 2 HI TOM 1
D3 50	RIDE CYMBAL 1								SYNTH 1 RIDE	SYNTH 2 RIDE 1
E3 52	CHINESE CYMBAL							REVERSE CYMBAL		
F3 53	RIDE BELL									
F#3 54	TAMBOURINE								SYNTH 1 TOMBURINE	
G3 55	SPASH CYMBAL									
G3 55	COWBELL								SYNTH 1 COWBELL	
A3 57	CRASH CYMBAL 2									SYNTH 2 CYMBAL 2
B3 59	VIBRA SLAP									
B3 59	RIDE CYMBAL 2									SYNTH 2 RIDE 2
C4 60	HIGH BONGO									
D4 62	LOW BONGO									
E4 63	MUTE HIGH CONGA								SYNTH 1 HIGH CONGA	
E4 64	OPEN HIGH CONGA								SYNTH 1 MID CONGA	
F4 65	LOW CONGA								SYNTH 1 LOW CONGA	
F4 65	HIGH TIMBALE									
G4 67	LOW TIMBALE									
G4 67	HIGH AGOGO									
A4 69	LOW AGOGO									
A4 69	CARACA									
B4 70	MARACAS								SYNTH 1 MARACAS	
B4 71	SHORT HI WHISTLE									
C5 72	LONG LOW WHISTLE									
C5 73	SHORT GUIRO									
D5 74	LONG GUIRO									
E5 76	CLAVES								SYNTH 1 CLAVES	
F5 77	HIGH WOOD BLOCK									
F5 77	LOW WOOD BLOCK									
G5 79	MUTE CUICA									
A5 81	OPEN CUICA									
A5 81	MUTE TRIANGLE									
B5 83	OPEN TRIANGLE									
B5 83	SINGLE BELL									
C6 84	BELL TREE									
C6 85	CASTANETS									
D6 86	MUTE SURDO									
E6 87	OPEN SURDO									
F6 88	APPLAUSE									
F6 89	APPLAUSE 2									
G6 91										
A6 93										
B6 95										
C7 96										
D7 98										
E7 100										
F7 101										
G7 103										
A7 105										
B7 107										
C8 108	STANDARD KICK 1a									
D8 110	STANDARD KICK 1b									
E8 112	STANDARD KICK 1c									
F8 113	STANDARD KICK 1d									
G8 115	STANDARD KICK 2a									
A8 117	STANDARD KICK 2b									
B8 119	STANDARD KICK 2c									
C8 120	STANDARD KICK 2d									
D8 119	STANDARD 1 SNARE a	STANDARD 2 SNARE a	STANDARD 3 SNARE a							
E8 121	STANDARD 1 SNARE b	STANDARD 2 SNARE b	STANDARD 3 SNARE b							
F8 123	STANDARD 1 SNARE c	STANDARD 2 SNARE c	STANDARD 3 SNARE c							
G8 125	STANDARD 1 SNARE d	STANDARD 2 SNARE d	STANDARD 3 SNARE d							
A8 127	CLOSED HI-HAT a									
B8 129	CLOSED HI-HAT b									
C8 131	CLOSED HI-HAT c									
D8 133	CLOSED HI-HAT d									
E8 135	PEDAL HI-HAT a									
F8 137	PEDAL HI-HAT b									
G8 139	OPEN HI-HAT a									
A8 141	OPEN HI-HAT b									

Appendix

Key/ Note number	DRUMS SET LIST								
	PC32: JAZZ SET	PC40: BRUSH SET	PC48: ORCHESTRA SET	PC64: HIP-HOP SET 1	PC65: HIP-HOP SET 2	PC66: TECHNO SET 1	PC67: TECHNO SET 2	PC68: DANCE SET 1	PC69: DANCE SET 2
C-1 0	Ca-1 1								
D-1 2	EJ-1 3								
E-1 4									
F-1 5	F#-1 6								
G-1 7	AJ-1 8								
A-1 9	BJ-1 10								
B-1 11									
C0 12									
C#0 13									
D0 14	E0 15								
E0 16									
F0 17	F#0 18								
G0 19	A0 20								
A0 21	B0 22								
B0 23									
C1 24									
D1 25									
E1 26	EJ1 27								
F1 28									
G1 29	F#1 30								
A1 31	AJ1 32								
B1 33	BJ1 34								
C2 35	JAZZ KICK 2	BRUSH KICK 2	JAZZ KICK 1	HIP-HOP KICK 2	HIP-HOP KICK 3	TECHNO KICK 2	TECHNO KICK 4	DANCE KICK 2	DANCE KICK 4
C#2 36	JAZZ KICK 1	BRUSH KICK 1	CONCERT BASS DRUM	HIP-HOP KICK 1	HIP-HOP KICK 2	TECHNO KICK 1	TECHNO KICK 3	DANCE KICK 1	DANCE KICK 3
D2 37	JAZZ SNARE 1	BRUSH TAP	CONCERT SNARE	HIP-HOP SNARE 1	HIP-HOP SNARE 3	TECHNO SNARE 1	TECHNO SNARE 3	DANCE SNARE 1	DANCE SNARE 3
E2 38	HAND CLAP 2	BRUSH SLAP	CASTANETS	HIP-HOP SNARE 2	HIP-HOP SNARE 4	TECHNO SNARE 2	TECHNO SNARE 4	DANCE SNARE 2	DANCE SNARE 4
E#2 39	JAZZ SNARE 2	BRUSH SWIRL	CONCERT SNARE	HIP-HOP SNARE 2	HIP-HOP SNARE 4	TECHNO SNARE 2	TECHNO SNARE 4	DANCE SNARE 2	DANCE SNARE 4
F2 40	F#2 42		TIMPANI F	HIP-HOP CHH	HIP-HOP CHH	TECHNO 1 CHH	TECHNO 2 CHH	HIP-HOP CHH	HIP-HOP CHH
G2 43	AJ2 44		TIMPANI G		SYNTH 2 LOW TOM 1	SYNTH 1 LOW TOM 1	SYNTH 1 LOW TOM 1		SYNTH 2 LOW TOM 1
A2 45			TIMPANI A	HIP-HOP PHH	HIP-HOP PHH	TECHNO 1 PHH	TECHNO 2 PHH	SYNTH 2 PHH	HIP-HOP PHH
B2 46			TIMPANI B		SYNTH 2 MID TOM 2	SYNTH 1 MID TOM 2	SYNTH 1 MID TOM 2		SYNTH 2 MID TOM 2
C3 48	CA3 48		TIMPANI C		SYNTH 2 HI TOM 2	TECHNO 1 OHH	TECHNO 2 OHH	SYNTH 2 OHH	HIP-HOP OHH
D3 50			TIMPANI D	HIP-HOP CLASH	SYNTH 2 CYMBAL	SYNTH 1 CYMBAL	TECHNO CYMBAL	HIP-HOP CLASH	TECHNO CYMBAL
E3 51			TIMPANI E		SYNTH 2 HI TOM 1	SYNTH 1 HI TOM 1	TECHNO CYMBAL	HIP-HOP CLASH	SYNTH 2 HI TOM 1
F3 53	F#3 54		TIMPANI F	HIP-HOP RIDE	SYNTH 2 RIDE	SYNTH 1 RIDE	TECHNO CYMBAL	HIP-HOP RIDE	TECHNO CYMBAL
G3 55	AJ3 56		TIMPANI G						
A3 57	BJ3 58		CONCERT CYMBAL 2	SYNTH 2 CYMBAL 2	SYNTH 2 CYMBAL 2				
B3 59			CONCERT CYMBAL 1	SYNTH 2 RIDE 2	SYNTH 2 RIDE 2				
C4 60	CA4 61								
D4 62	EJ4 63								
E4 64									
F4 65	F#4 66								
G4 67	AJ4 68								
A4 69	BJ4 70								
B4 71									
C5 72	CA5 73								
D5 74	EJ5 75								
E5 76									
F5 77	F#5 78								
G5 79	AJ5 80								
A5 81	BJ5 82								
B5 83	CA5 85								
C6 84									
D6 86	EJ6 87								
E6 88									
F6 89	F#6 90								
G6 91	AJ6 92								
A6 93	BJ6 94								
B6 95									
C7 96	CA7 97								
D7 98	EJ7 99								
E7 100									
F7 101	F#7 102								
G7 103	AJ7 104								
A7 105	BJ7 106								
B7 107									
C8 108	CA8 109								
D8 110	EJ8 111								
E8 112									
F8 113	F#8 114								
G8 115	AJ8 116								
A8 117	BJ8 118								
B8 119									
C9 120	CA9 121								
D9 122	EJ9 123								
E9 124									
F9 125	F#9 126								
G9 127									

Rhythm List

No.	Rhythm Name	HOUSE	MELLOW R&B	LATIN/VARIOUS	PIANO BALLAD
8 BEAT					
000	8 BEAT 1	069	034	105	141
001	8 BEAT 2	070	035	106	142
002	8 BEAT 3	071	036	107	143
003	8 BEAT 4	072	037	108	144
004	8 BEAT 5	073	038	109	145
005	8 BEAT POP 1	074	BALLAD	110	146
006	8 BEAT POP 2	075	039	111	147
007	8 BEAT POP 3	076	040	112	148
008	8 BEAT POP 4	077	041	113	149
009	60'S SOUL	078	042	114	150
010	8 BEAT DANCE	079	043	115	151
011	POP ROCK 1	080	044	116	152
012	POP ROCK 2	JAZZ	045	117	153
16 BEAT					
013	16 BEAT 1	081	046	118	154
014	16 BEAT 2	082	047	119	155
015	16 BEAT 3	083	048	120	156
016	16 BEAT 4	084	049	121	157
017	SLOW 16 BEAT	085	ROCK	122	158
018	16 BEAT SHUFFLE 1	086	051	123	159
019	16 BEAT SHUFFLE 2	087	052	124	
020	16 BEAT SHUFFLE 3	088	053	125	
021	16 BEAT SHUFFLE 4	089	054	126	
022	FUNK 1	090	055	127	
023	FUNK 2	091	056	128	
024	FUSION	092	057	129	
025	LATIN FUSION	EUROPEAN	058	130	
POPS					
026	POP 1	093	059	131	
027	POP 2	094	060	132	
028	GUITAR POP	095	DANCE	133	
029	POP WALTZ	096	061	134	
030	POP SHUFFLE 1	097	062	135	
031	POP SHUFFLE 2	098	063	136	
032	SOUL POP	099	064	137	
033	WORLD POP	100	065	138	
		101	066	139	
		102	067	FOR PIANO	
		103	068	140	
		104			

User Rhythms

No.	Rhythm Name
160	METRONOME 4 BEAT
161	METRONOME 3 BEAT
162	METRONOME 2 BEAT
163	POP BEAT
164	URBAN 16 BEAT
165	SHUFFLE BALLAD
166	U.K. COCK
167	UNPLUGGED
168	CYBER TRANCE
169	2 STEP
170	BALLROOM FOX
171	PUNTA
172	BACHATA
173	RAI
174	ZOUK
175	CONCERTO

NOTE

- This list shows the initial factory default configuration, in which the user area (160 through 175) contains default rhythm data.
- System reset page E-73 clears all data stored in the user area.
- The CD-ROM that comes bundled with the keyboard can be used to return all rhythms to the initial factory defaults shown in this list. See "Returning the keyboard to its initial factory defaults" on page E-80 for details.

Fingered Chord Chart

Root \ Chord Type	M	m	7	m7	dim7	M7	dim	m7-5
C								
C#/(Db)								
D								
(D#)/Eb								
E								
F								
F#/(Gb)								
G								
(G#)/Ab								
A								
(A#)/Bb								
B								

* You can use the above fingerings to finger chords within the accompaniment keyboard range.

Chord Type Root	aug	sus4	7sus4	m add9	mM7	7-5	add9
C							
C#/(D♭)							
D							
(D#)/E♭							
E							
F							
F#/(G♭)							
G							
(G#)/A♭							
A							
(A#)/B♭							
B							

REVERB Effect List

No.	Display Name	Type Name
00	Room 1	Room 1
01	Room 2	Room 2
02	Room 3	Room 3
03	Hall 1	Hall 1
04	Hall 2	Hall 2
05	Plate 1	Plate 1
06	Delay	Delay
07	PanDelay	Pan Delay
08	Plate 2	Plate 2
09	Plate 3	Plate 3
10	LrgRoom 1	Large Room 1
11	LrgRoom 2	Large Room 2
12	Stadium 1	Stadium 1
13	Stadium 2	Stadium 2
14	LongDly 1	Long Delay 1
15	LongDly 2	Long Delay 2

CHORUS Effect List

No.	Display Name	Type Name
00	Chorus 1	Chorus 1
01	Chorus 2	Chorus 2
02	Chorus 3	Chorus 3
03	Chorus 4	Chorus 4
04	FBChorus	Feedback Chorus
05	Flanger1	Flanger 1
06	SDelay 1	Short Delay 1
07	SDelay 2	Short Delay 2
08	SFChorus	Soft Chorus
09	BRCChorus	Bright Chorus
10	DPCChorus	Deep Chorus
11	Flanger 2	Flanger 2
12	Flanger 3	Flanger 3
13	Flanger 4	Flanger 4
14	SDelay 3	Short Delay 3
15	SDelay 4	Short Delay 4

DSP Effect List

Settable parameters depend on the DSP type. Also, the parameters for each DSP type depend on the algorithm* associated with the DSP type. See the DSP Algorithm List on page A-16 for more information.
 * Effector structure and operation type

DSP No. ID	Algorithm	Display Name	DSP Name
Dynamics Fx			
[00]	03	Equalize	Equalizer
[01]	06	Comp 1	Compressor 1
[02]	06	Comp 2	Compressor 2
[03]	07	Limiter	Limiter
[04]	13	Enhancer	Enhancer Phaser
Phaser			
[05]	10	Phaser	Phaser
[06]	09	StPhaser	Stereo Phaser
Chorus			
[07]	16	Chorus 1	Chorus 1
[08]	17	Chorus 2	Chorus 2
[09]	19	Chorus 3	Chorus 3
[10]	18	Chorus 4	Chorus 4
[11]	M05	Enha Cho	Enhancer - Chorus
Flanger			
[12]	26	Flanger	Flanger
[13]	M07	EnhaFlan	Enhancer - Flanger

Equalizer List

No.	Display Name	Type Name
0	Standard	Standard
1	Bass +	Bass +
2	Treble +	Treble +
3	Loundness	Loundness
4	Mellow	Mellow
5	Bright	Bright
6	Rock	Rock
7	Dance	Dance
8	Jazz	Jazz
9	Classic	Classic

DSP No.	Algorithm ID	Display Name	DSP Name
[72]	M30	Crn Cho	Crunch - Chorus
[73]	M30	OdChorus	Overdrive - Chorus
[74]	M30	Dist Cho	Distortion - Chorus
[75]	M30	MetalCho	Metal - Chorus
[76]	M31	DistFlan	Distortion - Flanger
[77]	M31	Met Flan	Metal - Flanger
[78]	M28	CrnDelay	Crunch - Delay
[79]	M28	Od Delay	Overdrive - Delay
[80]	M28	DistDly 1	Distortion - Delay 1
[81]	M28	DistDly 2	Distortion - Delay 2
[82]	M28	MetalDly	Metal - Delay
[83]	M28	Fuzz Dly	Fuzz - Delay
[84]	M24	CrChoDly	Crunch - Chorus - Delay
[85]	M24	DsChoDly	Distortion - Chorus - Delay
[86]	M25	CmpCrDly	Compressor - Crunch - Delay
[87]	M26	AWhCrDly	Auto Wah - Crunch - Delay
[88]	M26	AWhOdDly	Auto Wah - Overdrive - Delay
[89]	M26	AWhDsDly	Auto Wah - Distortion - Delay
[90]	M27	LWWhOdDly	LFO Wah - Overdrive - Delay
[91]	M27	LWWhDsDly	LFO Wah - Distortion - Delay
SFX			
[92]	14	Ring Mod	Ring Modulator
[93]	M12	RgChoDly	Ring Modulator - Chorus - Delay
[94]	M13	RingDist	Ring Modulator - Distortion
[95]	15	Lo-Fi	Lo-Fi
[96]	M11	CompLoFi	Compressor - Lo-Fi
[97]	M14	LoFi Ref	Lo-Fi - Reflection
[98]	M15	Crn LoFi	Crunch - Lo-Fi
[99]	M15	DistLoFi	Distortion - Lo-Fi

DSP No.	Algorithm ID	Display Name	DSP Name
Pan/Tremolo Fx			
[44]	01	Tremolo	Tremolo
[45]	M09	Cho Trem	Chorus - Tremolo
[46]	00	Auto Pan	Auto Pan
[47]	M10	PhaAPan 1	Phaser - Auto Pan 1
[48]	M10	PhaAPan 2	Phaser - Auto Pan 2
[49]	M20	PhaChoAP	Phaser - Chorus - Auto Pan
Rotary Fx			
[50]	11	Rotary 1	Rotary 1
[51]	11	Rotary 2	Rotary 2
[52]	12	Od Rot 1	Overdrive - Rotary 1
[53]	12	Od Rot 2	Overdrive - Rotary 2
[54]	M17	RotRef 1	Rotary - Reflection 1
[55]	M17	RotRef 2	Rotary - Reflection 2
[56]	M17	RotRef 3	Rotary - Reflection 3
[57]	M16	OdRtRef 1	Overdrive - Rotary - Reflection 1
[58]	M16	OdRtRef 2	Overdrive - Rotary - Reflection 2
[59]	M16	OdRtRef 3	Overdrive - Rotary - Reflection 3
Wah Fx			
[60]	04	LFO Wah	LFO Wah
[61]	05	Auto Wah	Auto Wah
[62]	M21	AWhChDly	Auto Wah - Chorus - Delay
[63]	M22	LWWhChDly	LFO Wah - Chorus - Delay
Guitar Fx			
[64]	08	Crunch	Crunch
[65]	08	Ovrdrive	Overdrive
[66]	08	Dist 1	Distortion 1
[67]	08	Dist 2	Distortion 2
[68]	08	Metal	Metal
[69]	08	Fuzz	Fuzz
[70]	M29	CrnPhase	Crunch - Phaser
[71]	M29	Od Phase	Overdrive - Phaser

DSP No.	Algorithm ID	Display Name	DSP Name
Delay			
[14]	28	Delay	Delay
[15]	22	3Tap Dly	3-Tap Delay
[16]	20	St Delay	Stereo Delay
[17]	21	SIXDelay	Stereo Cross Delay
[18]	M06	Enha Dly	Enhancer - Delay
[19]	25	Reflect	Reflection
Cho/Flanger/Delay Combination			
[20]	M02	PhaCho 1	Phaser - Chorus 1
[21]	M02	PhaCho 2	Phaser - Chorus 2
[22]	M04	PhaDly 1	Phaser - Delay 1
[23]	M04	PhaDly 2	Phaser - Delay 2
[24]	M00	ChoDly 1	Chorus - Delay 1
[25]	M00	ChoDly 2	Chorus - Delay 2
[26]	M01	ChoDly 3	Chorus - Delay 3
[27]	M01	ChoDly 4	Chorus - Delay 4
[28]	M19	CmpDelay	Compressor - Delay
[29]	M18	CmpEnDly	Compressor - Enhancer - Delay
[30]	M23	CmpChoRf	Compressor - Chorus - Reflection
[31]	M08	Cho Flan	Chorus - Flanger
[32]	M03	FlanDly 1	Flanger - Delay 1
[33]	M03	FlanDly 2	Flanger - Delay 2
Reverb			
[34]	27	RvbRoom1	Reverb Room 1
[35]	27	RvbRoom2	Reverb Room 2
[36]	27	RvbRoom3	Reverb Room 3
[37]	27	RvbHall 1	Reverb Hall 1
[38]	27	RvbHall 2	Reverb Hall 2
[39]	27	RvbPlate	Reverb Plate
[40]	23	GateRvb 1	Gate Reverb 1
[41]	23	GateRvb 2	Gate Reverb 2
[42]	24	GateRvb 3	Gate Reverb 3
[43]	24	GateRvb 4	Gate Reverb 4

00 : Auto Pan

■ Function

Continually performs left-right panning of the input signal in accordance with an LFO.

■ Parameters

- 0 : Rate (Range: 0 to 127)
Adjusts the panning rate.
- 1 : Depth (Range: 0 to 127)
Adjusts the panning depth.

01 : Tremolo

■ Function

Adjusts volume of input signal in accordance with an LFO.

■ Parameters

- 0 : Rate (Range: 0 to 127)
Adjusts the tremolo rate.
- 1 : Depth (Range: 0 to 127)
Adjusts the tremolo depth.

02 : 2BandEQ

■ Function

This is a two-band equalizer.

■ Parameters

- 0 : Low Frequency (Range: 0 (200Hz), 1 (400Hz), 2 (800Hz))
Adjusts the cutoff frequency of the low-band equalizer.
- 1 : Low Gain (Range: -12, -11, -10 to 0 to +10, +11, +12)
Adjusts the gain of the low-band equalizer.
- 2 : High Frequency (Range: 0 (6.0KHz), 1 (8.0KHz), 2 (10KHz))
Adjusts the cutoff frequency of the high-band equalizer.

- 3 : High Gain (Range: -12, -11, -10 to 0 to +10, +11, +12)
Adjusts the gain of the high-band equalizer.

03 : 3BandEQ

■ Function

This is a three-band equalizer.

■ Parameters

- 0 : Low Frequency (Range: 0 (200Hz), 1 (400Hz), 2 (800Hz))
Adjusts the cutoff frequency of the low-band equalizer.
- 1 : Low Gain (Range: -12, -11, -10 to 0 to +10, +11, +12)
Adjusts the gain of the low-band equalizer.
- 2 : Mid Frequency (Range: 0 (1.0KHz), 1 (1.3KHz), 2 (1.6KHz), 3 (2.0KHz), 4 (3.0KHz), 5 (4.0KHz), 6 (6.0KHz), 7 (8.0KHz))
Adjusts the center frequency of the mid-band equalizer.
- 3 : Mid Gain (Range: -12, -11, -10 to 0 to +10, +11, +12)
Adjusts the gain of the mid-band equalizer.

- 4 : High Frequency (Range: 0 (6.0KHz), 1 (8.0KHz), 2 (10KHz))
Adjusts the cutoff frequency of the high-band equalizer.

- 5 : High Gain (Range: -12, -11, -10 to 0 to +10, +11, +12)
Adjusts the gain of the high-band equalizer.

04 : LFO Wah

■ Function

This is a “wah” effect that can automatically affect the frequency in accordance with an LFO.

■ Parameters

- 0 : Input Level (Range: 0 to 127)
Adjusts the input level. The input signal can become distorted when the level of the sound being input, the number of chords, or the Resonance value is large. Adjust this parameter to eliminate such distortion.
- 1 : Resonance (Range: 0 to 127)
Adjusts the resonance of the sound.
- 2 : Manual (Range: 0 to 127)
Adjusts the frequency used as the basis for the wah filter.
- 3 : LFO Rate (Range: 0 to 127)
Adjusts the rate of the LFO.
- 4 : LFO Depth (Range: 0 to 127)
Adjusts the depth of the LFO.

05 : Auto Wah

■ Function

This is a “wah” effect that can automatically affect the frequency in accordance with the level of the input signal.

■ Parameters

- 0 : Input Level (Range: 0 to 127)
Adjusts the input level. The input signal can become distorted when the level of the sound being input, the number of chords, or the Resonance value is large. Adjust this parameter to eliminate such distortion.
- 1 : Resonance (Range: 0 to 127)
Adjusts the resonance of the sound.
- 2 : Manual (Range: 0 to 127)
Adjusts the frequency used as the basis for the wah filter.

- 3 : Depth(Range: -64 to 0 to +63)
Adjusts the depth of the wah in accordance with the level of the input signal.
Setting a positive value causes the wah filter to open in direct proportion with the size of the input signal, producing a bright sound.
Setting a negative value causes the Wah filter to close in accordance with the size of the input signal, which produces a dark tone quality. However, large input re-opens the Wah filter, even if it is closed.

06 : Compressor

- Function
Compresses the input signal, which can have the effect of suppressing level variation and making it possible to sustain dampened sounds longer.

■ Parameters

- 0 : Depth (Range: 0 to 127)
Adjusts compression of the audio signal.
- 1 : Attack (Range: 0 to 127)
Adjusts the attack amount of the input signal. A smaller value causes prompt compressor operation, which suppresses the attack of the input signal.
A larger value delays compressor operation, which causes attack to be output as-is.
- 2 : Release (Range: 0 to 127)
Adjusts the time from the point when the input signal drops below a certain level until the compression operation is stopped.

When an attack feeling is desired (no compression at the onset of the sound), set this parameter to as low a value as possible.
To have compression applied at all times, set a high value.

- 3 : Level (Range: 0 to 127)
Adjusts the output level.
The output volume changes in accordance with the Depth setting and the characteristics of the input tone. Use this parameter to correct for such changes.

07 : Limiter

- Function
This is an effector that you can use to set an upper limit value on the level of the input signal.

■ Parameters

- 0 : Limit (Range: 0 to 127)
Adjusts the volume level from which the limit is applied.
- 1 : Attack (Range: 0 to 127)
Adjusts the attack amount of the input signal.
- 2 : Release (Range: 0 to 127)
Adjusts the time from when the input signal drops below a certain level until the limit operation stops.

- 3 : Level (Range: 0 to 127)
The output volume changes in accordance with the Limit setting and the characteristics of the input tone. Use this parameter to correct for such changes.

08 : Distortion

- Function
This effect provides Distortion + AmpSimulator.
- Parameters
- 0 : Gain (Range: 0 to 127)
Adjusts the input gain.

- 1 : Low (Range: 0 to 127)
Adjusts the low-band gain.
The cutoff frequency differs according to the preset DSP.
- 2 : High (Range: 0 to 127)
Adjusts the high-band gain.
The cutoff frequency differs according to the preset DSP.
- 3 : Level (Range: 0 to 127)
Adjusts the output level.

09 : Stereo Phaser

■ Function

This is a stereo phaser that modulates the phase in accordance with a sine wave LFO.

■ Parameters

- 0 : Resonance (Range: 0 to 127)
Adjusts the resonance of the sound.
- 1 : Manual (Range: -64 to 0 to +63)
Adjusts the phaser shift volume, which is used for reference.
- 2 : Rate (Range: 0 to 127)
Adjusts the rate of the LFO.
- 3 : Depth (Range: 0 to 127)
Adjusts the depth of the LFO.
- 4 : Wet Level (Range: 0 to 127)
Adjusts the volume level of the effect.

10 : Phaser

■ Function

This is a monaural phaser that modulates the phase in accordance with a sine wave LFO.

■ Parameters

- 0 : Resonance (Range: 0 to 127)
Adjusts the resonance of the sound.
- 1 : Manual (Range: -64 to 0 to +63)
Adjusts the phaser shift volume, which is used for reference.

- 2 : Rate (Range: 0 to 127)
Adjusts the rate of the LFO.
- 3 : Depth (Range: 0 to 127)
Adjusts the depth of the LFO.
- 4 : Wet Level (Range: 0 to 127)
Adjusts the level of the effect sound.

11 : Rotary

■ Function
This is a rotary speaker simulator.

- Parameters
0 : Speed (Range: Slow, Fast)
Switches the speed mode between fast and slow.
- 1 : Break (Range: Rotate, Stop)
Stops speaker rotation.
- 2 : Fall Accel (Range: 0 to 127)
Adjusts acceleration when the speed mode is switched from fast to slow.
- 3 : Rise Accel (Range: 0 to 127)
Adjusts acceleration when the speed mode is switched from slow to fast.
- 6 : Slow Rate (Range: 0 to 127)
Adjusts speaker rotation speed of the slow speed mode.
- 7 : Fast Rate (Range: 0 to 127)
Adjusts speaker rotation speed of the fast speed mode.

- 2 : Speed (Range: Slow, Fast)
Switches the speed mode between fast and slow.
- 3 : Break (Range: Rotate, Stop)
Stops speaker rotation.
- 4 : Fall Accel (Range: 0 to 127)
Adjusts acceleration when the speed mode is switched from fast to slow.
- 5 : Rise Accel (Range: 0 to 127)
Adjusts acceleration when the speed mode is switched from slow to fast.
- 6 : Slow Rate (Range: 0 to 127)
Adjusts speaker rotation speed of the slow speed mode.
- 7 : Fast Rate (Range: 0 to 127)
Adjusts speaker rotation speed of the fast speed mode.

- 3 : Break (Range: Rotate, Stop)
Stops speaker rotation.
- 4 : Fall Accel (Range: 0 to 127)
Adjusts acceleration when the speed mode is switched from fast to slow.
- 5 : Rise Accel (Range: 0 to 127)
Adjusts acceleration when the speed mode is switched from slow to fast.

- 4 : Fall Accel (Range: 0 to 127)
Adjusts acceleration when the speed mode is switched from fast to slow.
- 5 : Rise Accel (Range: 0 to 127)
Adjusts acceleration when the speed mode is switched from slow to fast.

- 5 : Rise Accel (Range: 0 to 127)
Adjusts acceleration when the speed mode is switched from slow to fast.
- 6 : Slow Rate (Range: 0 to 127)
Adjusts speaker rotation speed of the slow speed mode.
- 7 : Fast Rate (Range: 0 to 127)
Adjusts speaker rotation speed of the fast speed mode.

- 6 : Slow Rate (Range: 0 to 127)
Adjusts speaker rotation speed of the slow speed mode.
- 7 : Fast Rate (Range: 0 to 127)
Adjusts speaker rotation speed of the fast speed mode.

- 7 : Fast Rate (Range: 0 to 127)
Adjusts speaker rotation speed of the fast speed mode.

13 : Enhancer

■ Function

Enhances the outlines of the low range and high range of the input signal.

■ Parameters

- 0 : Low Frequency (Range: 0 to 127)
Adjusts the low range enhancer frequency.
- 1 : Low Gain (Range: 0 to 127)
Adjusts the low range enhancer gain.
- 2 : High Frequency (Range: 0 to 127)
Adjusts the high range enhancer frequency.
- 3 : High Gain (Range: 0 to 127)
Adjusts the high range enhancer gain.

14 : Ring Modulator

■ Function

This is a ring modulator (AM modulator) that makes it possible to modulate the frequency of internal oscillator (OSC) in accordance with an internal LFO.

■ Parameters

- 0 : Overdrive Gain (Range: 0 to 127)
Adjusts overdrive gain.
- 1 : Overdrive Level (Range: 0 to 127)
Adjusts the output level of the overdrive.

- Parameters
0 : OSC Frequency (Range: 0 to 127)
Sets the reference frequency of the internal OSC.
- 1 : LFO Rate (Range: 0 to 127)
Adjusts the rate of the LFO.
- 2 : LFO Depth (Range: 0 to 127)
Adjusts the depth of the LFO.
- 3 : Wet Level (Range: 0 to 127)
Adjusts the level of the effect sound.
- 4 : Dry Level (Range: 0 to 127)
Adjusts the level of the original sound.

15 : Lo-Fi

■ Function

This is an effector that reproduces a retro-type Lo-Fi sound using Noise Generator 1 (phonograph record player type scratch noise generator) and Noise Generator 2 (FM radio type white noise and pink noise continuous noise generator), and by noise modulation (amplitude modulation = AM) and distortion of frequency characteristics.

■ Parameters

- 0 : Noise Level 1 (Range: 0 to 127)
Adjusts the level of Noise Generator 1.
- 1 : Noise Density 1 (Range: 0 to 127)
Adjusts the noise density of Noise Generator 1.
- 2 : Noise Level 2 (Range: 0 to 127)
Adjusts the level of Noise Generator 2.
- 3 : Noise Density 2 (Range: 0 to 127)
Adjusts the noise density of Noise Generator 2.
- 4 : Tone (Range: 0 to 127)
Adjusts the tone.
- 5 : Resonance (Range: 0 to 127)
Adjusts the resonance of the sound.

- 6 : Bass(Range: -64 to 0 to +63)
Adjusts the volume of low sounds.
- 7 : Level (Range: 0 to 127)
Adjusts the output level.

16 : 1-Phase Chorus

■ Function
This is monaural chorus in accordance with a sine wave LFO.

- Parameters
- 0 : LFO Rate (Range: 0 to 127)
Adjusts the rate of the LFO.
 - 1 : LFO Depth (Range: 0 to 127)
Adjusts the depth of the LFO.
 - 2 : Feedback (Range: -64 to 0 to +63)
Adjusts the feedback of the sound.
 - 3 : Wet Level (Range: 0 to 127)
Adjusts the level of the effect sound.

17 : Sin 2-Phase Chorus

■ Function
This is stereo chorus in accordance with a sine wave LFO.

- Parameters
- 0 : LFO Rate (Range: 0 to 127)
Adjusts the rate of the LFO.
 - 1 : LFO Depth (Range: 0 to 127)
Adjusts the depth of the LFO.
 - 2 : Feedback (Range: -64 to 0 to +63)
Adjusts the feedback of the sound.
 - 3 : Wet Level (Range: 0 to 127)
Adjusts the level of the effect sound.

18 : 3-Phase Chorus

■ Function
This is 3-phase chorus in accordance with two LFOs of with different sine wave rates.

- Parameters
- 0 : Rate1 (Fast LFO Rate) (Range: 0 to 127)
Adjusts the rate of LFO1.
 - 1 : Depth1 (Fast LFO Depth) (Range: 0 to 127)
Adjusts the depth of LFO1.
 - 2 : Rate2 (Slow LFO Rate) (Range: 0 to 127)
Adjusts the rate of LFO2.
 - 3 : Depth2 (Slow LFO Depth) (Range: 0 to 127)
Adjusts the depth of LFO2.
 - 4 : Wet Level (Range: 0 to 127)
Adjusts the level of the effect sound.

19 : Tri 2-Phase Chorus

■ Function
This is stereo chorus in accordance with triangular wave LFO.

- Parameters
- 0 : LFO Rate (Range: 0 to 127)
Adjusts the rate of the LFO.
 - 1 : LFO Depth (Range: 0 to 127)
Adjusts the depth of the LFO.
 - 2 : Feedback(Range: -64 to 0 to +63)
Adjusts the feedback of the sound.
 - 3 : Wet Level (Range: 0 to 127)
Adjusts the level of the effect sound.

20 : Stereo Delay 1

■ Function
This is delay of stereo input and output.

- Parameters
- 0 : Delay Time (Range: 0 to 127)
Adjusts the delay time.
 - 1 : Wet Level (Range: 0 to 127)
Adjusts the level of the effect sound.
 - 2 : Feedback (Range: 0 to 127)
Adjusts the repeat of the delay.

- 3 : High Damp (Range: 0 to 127)
Adjusts damping of the high-range delay sound.
The smaller the value, the greater the damping of high-range delay sound.
- 4 : Ratio L (Range: 0 to 127)
Adjusts the delay time of the left channel.
Proportional to the value set for Delay Time.
- 5 : Ratio R (Range: 0 to 127)
Adjusts the delay time of the right channel.
Proportional to the value set for Delay Time.

21 : Stereo Delay 2

■ Function
This is cross feedback delay of stereo input and output.

- Parameters
- 0 : Delay Time (Range: 0 to 127)
Adjusts the delay time.
 - 1 : Wet Level (Range: 0 to 127)
Adjusts the level of the effect sound.
 - 2 : Feedback (Range: 0 to 127)
Adjusts the repeat of the delay.
 - 3 : High Damp (Range: 0 to 127)
Adjusts damping of the high-range delay sound.
The smaller the value, the greater the damping of high-range delay sound.
 - 4 : Ratio L (Range: 0 to 127)
Adjusts the delay time of the left channel.
Proportional to the value set for Delay Time.
 - 5 : Ratio R (Range: 0 to 127)
Adjusts the delay time of the right channel.
Proportional to the value set for Delay Time.

22 : 3-Tap Delay

■ Function
This is left / center / right 3-tap delay.

25 : Reflection

■ **Function**
This is an effector that extracts the first reflected sound from a reverb sound.

■ **Parameters**
0 : Type (Range: 0 to 7)
Selects from among the eight available reflection patterns.
1 : Wet Level (Range: 0 to 127)
Adjusts the level of the effect sound.
2 : Feedback (Range: 0 to 127)
Adjusts the repeat of the reflected sound.
3 : Tone (Range: 0 to 127)
Adjusts the tone of the reflected sound.

26 : Flanger

■ **Function**
This is a flanger in accordance with a sine wave LFO.

■ **Parameters**
0 : LFO Rate (Range: 0 to 127)
Adjusts the rate of the LFO.
1 : LFO Depth (Range: 0 to 127)
Adjusts the depth of the LFO.
2 : Feedback (Range: -64 to 0 to +63)
Adjusts the feedback of the sound.
3 : Wet Level (Range: 0 to 127)
Adjusts the level of the effect sound.

27 : Reverb

■ **Function**
This is an effector that preserves the breadth of a sound by adding a reverb sound.

■ **Parameters**
0 : Tone (Range: 0 to 127)
Adjusts the tone of the reverb sound.

3 : High Damp (Range: 0 to 127)
Adjusts damping of the high-range delay sound.
The smaller the value, the greater the damping of high-range delay sound.
4 : Diffusion (Range: 0 to 127)
Provides fine adjustment of the reverb.
5 : Wet Level (Range: 0 to 127)
Adjusts the level of the effect sound.
6 : Dry Level (Range: 0 to 127)
Adjusts the level of the original sound.

24 : Reverse Gate Reverb

■ **Function**
This is gate reverb with a reverse rotation effect.

■ **Parameters**
0 : LPF (Range: 0 to 127)
Adjusts the cutoff frequency of the low-pass filter.
A smaller value cuts the high range.
1 : HPF (Range: 0 to 127)
Adjusts the cutoff frequency of the high-pass filter.
A larger value cuts the low range.
2 : Feedback (Range: 0 to 127)
Adjusts the repeat of the reverb.
3 : High Damp (Range: 0 to 127)
Adjusts damping of the high-range reverb sound.
The smaller the value, the greater the damping of high-range reverb sound.
4 : Diffusion (Range: 0 to 127)
Provides fine adjustment of the reverb.
5 : Wet Level (Range: 0 to 127)
Adjusts the level of the effect sound.
6 : Dry Level (Range: 0 to 127)
Adjusts the level of the original sound.

23 : Gate Reverb

■ **Function**
This is a fader that creates artificial reverb that sounds like it is being cut with a gate.

■ **Parameters**
0 : LPF (Range: 0 to 127)
Adjusts the cutoff frequency of the low-pass filter.
A smaller value cuts the high range.
1 : HPF (Range: 0 to 127)
Adjusts the cutoff frequency of the high-pass filter.
A larger value cuts the low range.
2 : Feedback (Range: 0 to 127)
Adjusts the repeat of the reverb.

■ **Parameters**
0 : Delay Time (Range: 0 to 127)
Adjusts the delay time.
1 : Wet Level (Range: 0 to 127)
Adjusts the level of the effect sound.
2 : Feedback (Range: 0 to 127)
Adjusts the repeat of the delay.
3 : High Damp (Range: 0 to 127)
Adjusts damping of the high-range delay sound.
The smaller the value, the greater the damping of high-range delay sound.
4 : Ratio L (Range: 0 to 127)
Adjusts the delay time of the left channel.
Proportional to the value set for Delay Time.
5 : Ratio C (Range: 0 to 127)
Adjusts the delay time of the center channel.
Proportional to the value set for Delay Time.
6 : Ratio R (Range: 0 to 127)
Adjusts the delay time of the right channel.
Proportional to the value set for Delay Time.

23 : Gate Reverb

■ **Function**
This is a fader that creates artificial reverb that sounds like it is being cut with a gate.

■ **Parameters**
0 : LPF (Range: 0 to 127)
Adjusts the cutoff frequency of the low-pass filter.
A smaller value cuts the high range.
1 : HPF (Range: 0 to 127)
Adjusts the cutoff frequency of the high-pass filter.
A larger value cuts the low range.
2 : Feedback (Range: 0 to 127)
Adjusts the repeat of the reverb.

- 1 : Time (Range: 0 to 127)
Adjusts the reverb time.
- 2 : High Damp (Range: 0 to 127)
Adjusts damping of the high-range reverb sound.
The smaller the value, the greater the damping of high-range reverb sound.
- 3 : ER Level (Range: 0 to 127)
Adjusts the level of the initial reflection.
- 4 : Wet Level (Range: 0 to 127)
Adjusts the level of the effect sound.

28 : 2-Tap Delay

- Function
This is left/right 2-tap delay.

- Parameters
 - 0 : Delay Time (Range: 0 to 127)
Adjusts the delay time.
 - 1 : Wet Level (Range: 0 to 127)
Adjusts the level of the effect sound.
 - 2 : Feedback (Range: 0 to 127)
Adjusts the repeat of the delay.
 - 3 : High Damp (Range: 0 to 127)
Adjusts damping of the high-range delay sound.
The smaller the value, the greater the damping of high-range delay sound.
 - 4 : Ratio L (Range: 0 to 127)
Adjusts the delay time of the left channel.
Proportional to the value set for Delay Time.
 - 5 : Ratio R (Range: 0 to 127)
Adjusts the delay time of the right channel.
Proportional to the value set for Delay Time.

★ The following “Multi” algorithms are used in combination with the algorithms described above. Parameters are shared by both types of algorithms.

M00 : Multi00 (Sin 2-Phase Chorus – 2-Tap Delay)

- Function
This is a multi effector that is related to Sin 2-Phase Chorus - 2-Tap Delay.

- Parameters
 - 0 : Chorus LFO Rate
 - 1 : Chorus LFO Depth
 - 2 : Chorus Feedback
 - 3 : Chorus Wet Level
 - 4 : Delay Time
 - 5 : Delay Wet Level
 - 6 : Delay Feedback
 - 7 : Delay High Damp

M01 : Multi01 (3-Phase Chorus – 3-Tap Delay)

- Function
This is a multi effector that is related to 3-Phase Chorus - 3-Tap Delay.

- Parameters
 - 0 : Chorus Rate 1
 - 1 : Chorus Depth 1
 - 2 : Chorus Rate 2
 - 3 : Chorus Depth 2
 - 4 : Chorus Wet Level
 - 5 : Delay Time
 - 6 : Delay Wet Level
 - 7 : Delay Feedback

M02 : Multi02 (Phaser – 3-Phase Chorus)

- Function
This is a multi effector that is related to Phaser - 3-Phase Chorus.

- Parameters
 - 0 : Phaser Resonance
 - 1 : Phaser Manual
 - 2 : Phaser Rate
 - 3 : Phaser Depth
 - 4 : Chorus Rate 1
 - 5 : Chorus Depth 1
 - 6 : Chorus Rate 2
 - 7 : Chorus Depth 2

M03 : Multi03 (Flanger – 2-Tap Delay)

- Function
This is a multi effector that is related to Flanger - 2-Tap Delay.

- Parameters
 - 0 : Flanger LFO Rate
 - 1 : Flanger LFO Depth
 - 2 : Flanger Feedback
 - 3 : Flanger Wet Level
 - 4 : Delay Time
 - 5 : Delay Wet Level
 - 6 : Delay Feedback
 - 7 : Delay High Damp

M04 : Multi04 (Stereo Phaser – Stereo Delay 1)

- Function
This is a multi effector that is related to Stereo Phaser - Stereo Delay 1.

- Parameters
 - 0 : Phaser Resonance
 - 1 : Phaser Manual
 - 2 : Phaser Rate
 - 3 : Phaser Depth
 - 4 : Phaser Wet Level
 - 5 : Delay Time

- 6 : Delay Wet Level
- 7 : Delay Feedback

M05 : Multi05 (Enhancer – 1-Phase Chorus)

■ Function

This is a multi effector related to Enhancer - 1-Phase Chorus.

■ Parameters

- 0 : Enhancer Low Frequency
- 1 : Enhancer Low Gain
- 2 : Enhancer High Frequency
- 3 : Enhancer High Gain
- 4 : Chorus LFO Rate
- 5 : Chorus LFO Depth
- 6 : Chorus Feedback
- 7 : Chorus Wet Level

M06 : Multi06 (Enhancer – 2-Tap Delay)

■ Function

This is a multi effector that is related to Enhancer - 2-Tap Delay.

■ Parameters

- 0 : Enhancer Low Frequency
- 1 : Enhancer Low Gain
- 2 : Enhancer High Frequency
- 3 : Enhancer High Gain
- 4 : Delay Time
- 5 : Delay Wet Level
- 6 : Delay Feedback
- 7 : Delay High Damp

M07 : Multi07 (Enhancer – Flanger)

■ Function

This is a multi effector related to Enhancer - Flanger.

■ Parameters

- 0 : Enhancer Low Frequency
- 1 : Enhancer Low Gain
- 2 : Enhancer High Frequency
- 3 : Enhancer High Gain
- 4 : Flanger LFO Rate
- 5 : Flanger LFO Depth
- 6 : Flanger Feedback
- 7 : Flanger Wet Level

M08: Multi08 (Sin 2-Phase Chorus – Flanger)

■ Function

This is a multi effector that is related to Sin 2-Phase Chorus - Flanger.

■ Parameters

- 0 : Chorus LFO Rate
- 1 : Chorus LFO Depth
- 2 : Chorus Feedback
- 3 : Chorus Wet Level
- 4 : Flanger LFO Rate
- 5 : Flanger LFO Depth
- 6 : Flanger Feedback
- 7 : Flanger Wet Level

M09 : Multi09 (Sin 2-Phase Chorus – Tremolo)

■ Function

This is a multi effector that is related to Sin 2-Phase Chorus - Tremolo.

■ Parameters

- 0 : Chorus LFO Rate
- 1 : Chorus LFO Depth
- 2 : Chorus Feedback
- 3 : Chorus Wet Level
- 4 : Tremolo Rate
- 5 : Tremolo Depth

M10 : Multi10 (Stereo Phaser – Auto Pan)

■ Function

This is a multi effector that is related to Stereo Phaser - Auto Pan.

■ Parameters

- 0 : Phaser Resonance
- 1 : Phaser Manual
- 2 : Phaser Rate
- 3 : Phaser Depth
- 4 : Phaser Wet Level
- 5 : Auto Pan Rate
- 6 : Auto Pan Depth

M11 : Multi11 (Compressor – Lo-Fi)

■ Function

This is a multi effector related to Compressor - Lo-Fi.

■ Parameters

- 0 : Compressor Depth
- 1 : Compressor Attack
- 2 : Compressor Level
- 3 : Lo-Fi Noise 1
- 4 : Lo-Fi Noise 2
- 5 : Lo-Fi Tone
- 6 : Lo-Fi Resonance
- 7 : Lo-Fi Bass

M12 : Multi12 (Ring Modulator – Sin 2-Phase Chorus - 2-Tap Delay)

■ Function

This is a multi effector that is related to Ring Modulator - Sin 2-Phase Chorus.

■ Parameters

- 0 : Ring OSC Frequency
- 1 : Ring LFO Rate
- 2 : Ring LFO Depth

- 3 : Ring Wet Level
- 4 : Ring Dry Level
- 5 : Chorus LFO Depth
- 6 : Delay Time
- 7 : Delay Wet Level

M13 : Multi13 (Ring Modulator – Distortion)

- **Function**
This is a multi effector related to Ring Modulator - Distortion.

- **Parameters**
 - 0 : Ring OSC Frequency
 - 1 : Ring LFO Rate
 - 2 : Ring LFO Depth
 - 3 : Ring Wet Level
 - 4 : Ring Dry Level
 - 5 : Distortion Gain
 - 6 : Distortion Tone
 - 7 : Distortion Level

M14 : Multi14 (Lo-Fi – Reflection)

- **Function**
This is a multi effector related to Lo-Fi - Reflection.

- **Parameters**
 - 0 : Lo-Fi Noise1
 - 1 : Lo-Fi Noise2
 - 2 : Lo-Fi Tone
 - 3 : Lo-Fi Resonance
 - 4 : Reflection Type
 - 5 : Reflection Wet Level
 - 6 : Reflection Feedback
 - 7 : Reflection Tone

M15 : Multi15 (Distortion – Lo-Fi)

- **Function**
This is a multi effector related to Distortion - Lo-Fi.

- **Parameters**
 - 0 : Distortion Gain
 - 1 : Distortion Low
 - 2 : Distortion High
 - 3 : Distortion Level
 - 4 : Lo-Fi Noise1
 - 5 : Lo-Fi Noise2
 - 6 : Lo-Fi Tone
 - 7 : Lo-Fi Resonance

M16 : Multi16 (Drive Rotary – Reflection)

- **Function**
This is a multi effector related to Drive Rotary - Reflection.

- **Parameters**
 - 0 : Drive Rotary Gain
 - 1 : Drive Rotary Level
 - 2 : Drive Rotary Speed
 - 3 : Drive Rotary Slow Rate
 - 4 : Drive Rotary Fast Rate
 - 5 : Reflection Wet Level
 - 6 : Reflection Feedback
 - 7 : Reflection Tone

M17 : Multi17 (Rotary – Reflection)

- **Function**
This is a multi effector related to Rotary - Reflection.

- **Parameters**
 - 0 : Rotary Speed
 - 1 : Rotary Break
 - 2 : Rotary Slow Rate

- 3 : Rotary Fast Rate
- 4 : Reflection Wet Level
- 5 : Reflection Feedback
- 6 : Reflection Tone

M18 : Multi18 (Compressor – Enhancer - 2-Tap Delay)

- **Function**
This is a multi effector that is related to Compressor - Enhancer - 2-Tap Delay.

- **Parameters**
 - 0 : Compressor Depth
 - 1 : Compressor Attack
 - 2 : Compressor Level
 - 3 : Enhancer Low Gain
 - 4 : Enhancer High Gain
 - 5 : Delay Time
 - 6 : Delay Wet Level
 - 7 : Delay Feedback

M19 : Multi19 (Compressor – Stereo Delay 1)

- **Function**
This is a multi effector related to Compressor - Stereo Delay 1.

- **Parameters**
 - 0 : Compressor Depth
 - 1 : Compressor Attack
 - 2 : Compressor Release
 - 3 : Compressor Level
 - 4 : Delay Time
 - 5 : Delay Wet Level
 - 6 : Delay Feedback
 - 7 : Delay High Damp

M20 : Multi20 (Phaser – 1-Phase Chorus – Auto Pan)

■ Function

This is a multi effector that is related to Phaser - 1-Phase Chorus - Auto Pan.

■ Parameters

- 0 : Phaser Resonance
- 1 : Phaser Manual
- 2 : Phaser Rate
- 3 : Phaser Depth
- 4 : Chorus LFO Rate
- 5 : Chorus LFO Depth
- 6 : Auto Pan Rate
- 7 : Auto Pan Depth

M21 : Multi21 (Auto Wah – Tri 2-Phase Chorus – 2-Tap Delay)

■ Function

This is a multi effector that is related to Auto Wah - Tri 2-Phase Chorus - 2-Tap Delay.

■ Parameters

- 0 : Wah Resonance
- 1 : Wah Manual
- 2 : Wah Depth
- 3 : Chorus LFO Rate
- 4 : Chorus LFO Depth
- 5 : Delay Time
- 6 : Delay Wet Level
- 7 : Delay Feedback

M22 : Multi22 (LFO Wah – Tri 2-Phase Chorus – 2-Tap Delay)

■ Function

This is a multi effector that is related to LFO Wah - Tri 2-Phase Chorus - 2-Tap Delay.

■ Parameters

- 0 : Wah Resonance
- 1 : Wah Manual
- 2 : Wah LFO Rate
- 3 : Wah LFO Depth
- 4 : Chorus LFO Depth
- 5 : Delay Time
- 6 : Delay Wet Level
- 7 : Delay Feedback

M23 : Multi23 (Compressor – Sin 2-Phase Chorus – Reflection)

■ Function

This is a multi effector that is related to Compressor - Sin 2-Phase Chorus - Reflection.

■ Parameters

- 0 : Compressor Depth
- 1 : Compressor Attack
- 2 : Compressor Level
- 3 : Chorus LFO Rate
- 4 : Chorus LFO Depth
- 5 : Reflection Wet Level
- 6 : Reflection Feedback
- 7 : Reflection Tone

M24 : Multi24 (Distortion – 1-Phase Chorus – 2-Tap Delay)

■ Function

This is a multi effector that is related to Distortion - 1-Phase Chorus - 2-Tap Delay.

■ Parameters

- 0 : Distortion Gain
- 1 : Distortion Low
- 2 : Distortion High
- 3 : Distortion Level
- 4 : Chorus LFO Depth
- 5 : Delay Time

- 6 : Delay Wet Level
- 7 : Delay Feedback

M25 : Multi25 (Compressor – Distortion – 2-Tap Delay)

■ Function

This is a multi effector that is related to Compressor - Distortion - 2-Tap Delay.

■ Parameters

- 0 : Compressor Depth
- 1 : Distortion Gain
- 2 : Distortion Low
- 3 : Distortion High
- 4 : Distortion Level
- 5 : Delay Time
- 6 : Delay Wet Level
- 7 : Delay Feedback

M26 : Multi26 (Auto Wah – Distortion – 2-Tap Delay)

■ Function

This is a multi effector that is related to Auto Wah - Distortion - 2-Tap Delay.

■ Parameters

- 0 : Wah Manual
- 1 : Wah Depth
- 2 : Distortion Gain
- 3 : Distortion Tone
- 4 : Distortion Level
- 5 : Delay Time
- 6 : Delay Wet Level
- 7 : Delay Feedback

M27 : Multi27 (LFO Wah – Distortion – 2-Tap Delay)

■ **Function**

This is a multi effector that is related to LFO Wah - Distortion - 2-Tap Delay.

■ **Parameters**

- 0 : Wah Manual
- 1 : Wah LFO Rate
- 2 : Wah LFO Depth
- 3 : Distortion Gain
- 4 : Distortion Level
- 5 : Delay Time
- 6 : Delay Wet Level
- 7 : Delay Feedback

M28 : Multi28 (Distortion – 3-Tap Delay)

■ **Function**

This is a multi effector that is related to Distortion - 3-Tap Delay.

■ **Parameters**

- 0 : Distortion Gain
- 1 : Distortion Low
- 2 : Distortion High
- 3 : Distortion Level
- 4 : Delay Time
- 5 : Delay Wet Level
- 6 : Delay Feedback
- 7 : Delay High Damp

M29 : Multi29 (Distortion – Phaser)

■ **Function**

This is a multi effector related to Distortion - Phaser.

■ **Parameters**

- 0 : Distortion Gain
- 1 : Distortion Low

- 2 : Distortion High
- 3 : Distortion Level
- 4 : Phaser Resonance
- 5 : Phaser Manual
- 6 : Phaser Rate
- 7 : Phaser Depth

M30 : Multi30 (Distortion – Sin 2-Phase Chorus)

■ **Function**

This is a multi effector that is related to Distortion - Sin 2-Phase Chorus.

■ **Parameters**

- 0 : Distortion Gain
- 1 : Distortion Low
- 2 : Distortion High
- 3 : Distortion Level
- 4 : Chorus LFO Rate
- 5 : Chorus LFO Depth
- 6 : Chorus Feedback
- 7 : Chorus Wet Level

M31 : Multi31 (Distortion – Flanger)

■ **Function**

This is a multi effector related to Distortion - Flanger.

■ **Parameters**

- 0 : Distortion Gain
- 1 : Distortion Low
- 2 : Distortion High
- 3 : Distortion Level
- 4 : Flanger LFO Rate
- 5 : Flanger LFO Depth
- 6 : Flanger Feedback
- 7 : Flanger Wet Level

MIDI Implementation Chart

Function ...	Transmitted	Recognized	Remarks
Basic Channel Default Changed	1-16 1-16	1-16 1-16	
Mode Default Messages Altered	Mode 3 X *****	Mode 3 X *****	
Note Number True voice	0-127 *****	0-127 0-127 *1	*1: Depends on tone
Velocity Note ON Note OFF	0-9nH V = 1-127 X 9nH V = 0	0-9nH V = 1-127 X	
After Touch Key's Ch's	X X	X O	
Pitch Bender	O	O	
Control Change 0,32 1 6,38 7 10 11 16 17 18 19 64 66 67 71 72 73	O O O O X*2 O O O O O*3 O*3 O*3 O O O	O O O O O O O O O O O O O O O O O O O	Bank select Modulation Data entry Volume Pan Expression DSP Parameter0 DSP Parameter1 DSP Parameter2 DSP Parameter3 Hold1 Sostenuto Soft pedal Resonance Release Time Attack Time



This recycle mark indicates that the packaging conforms to the environmental protection legislation in Germany.

CASIO®