

CTK-671

USER'S GUIDE GUÍA DEL USUARIO



P

英西

CTK671-ES-1

CASIO®

GUIDELINES LAID DOWN BY FCC RULES FOR USE OF THE UNIT IN THE U.S.A. (not applicable to other areas).

NOTICE

This equipment has been tested and found to comply with the limits for a Class B digital device, pursuant to Part 15 of the FCC Rules. These limits are designed to provide reasonable protection against harmful interference in a residential installation. This equipment generates, uses and can radiate radio frequency energy and, if not installed and used in accordance with the instructions, may cause harmful interference to radio communications. However, there is no guarantee that interference will not occur in a particular installation. If this equipment does cause harmful interference to radio or television reception, which can be determined by turning the equipment off and on, the user is encouraged to try to correct the interference by one or more of the following measures:

- Reorient or relocate the receiving antenna.
- Increase the separation between the equipment and receiver.
- Connect the equipment into an outlet on a circuit different from that to which the receiver is connected.
- Consult the dealer or an experienced radio/TV technician for help.

FCC WARNING

Changes or modifications not expressly approved by the party responsible for compliance could void the user's authority to operate the equipment.

Welcome...

To the happy family of satisfied CASIO electronic musical instrument owners! To get the most out of the many features and functions of the keyboard, be sure to carefully read this manual and keep it on hand for future reference.

Important!

Please note the following important information before using this product.

- Before using the optional AD-5 Adaptor to power the unit, be sure to check the AC Adaptor for any damage first. Carefully check the power cord for breakage, cuts, exposed wire and other serious damage. Never let children use an AC adaptor that is seriously damaged.
- Never attempt to recharge batteries.
- Do not use rechargeable batteries.
- Never mix old batteries with new ones.
- Use recommended batteries or equivalent types.
- Always make sure that positive (+) and negative (-) poles are facing correctly as indicated near the battery compartment.
- Replace batteries as soon as possible after any sign they are getting weak.
- Do not short-circuit the battery terminals.
- The product is not intended for children under 3 years.
- Use only CASIO AD-5 adaptor.
- The AC adaptor is not a toy.
- Be sure to disconnect the AC adaptor before cleaning the product.



CASIO ELECTRONICS CO., LTD.
Unit 6, 1000
North Circular Road
London NW2 7JD, U.K.

This mark is valid in the EU countries only.
Please keep all information for future reference.



Introduction

Congratulations upon your selection of this CASIO musical instrument. This keyboard provides you with the following features and functions.

❑ **348 tones, including 100 “Advanced Tones”**

A total of 238 standard tones including piano, organ, brass, and other presets provide you with the sounds you need, while memory for 10 user tones lets you store your own original creations. 100 of the preset tones are “Advanced Tones,” which are variations of standard tones created by programming in effects (DSP) and other settings.

❑ **100 Preset Rhythms + 4 User Rhythms**

A selection of 100 rhythms includes accompaniments for everything from rock to pops and jazz.

You can also transfer accompaniment data from your computer and store up to four of them as user rhythms in keyboard memory.

❑ **Auto Accompaniment**

Simply play a chord and the corresponding rhythm, bass and chord parts play automatically. One-touch Presets instantly recalls the most suitable tone and tempo settings to match the rhythm you are using.

❑ **Big, Information-packed Display**

A big built-in display shows chord names, tempo setting, keyboard information, staff notation of notes played, and more for full support of all your keyboard play. A built-in backlight keeps the display easy to read, even in total darkness.

❑ **Song Memory**

Record up to six parts in memory, along with their tone, volume, pan position, and other parameters for later playback. Realistic ensemble play can also be created using the Auto Accompaniment function.

❑ **Synthesizer Mode**

Edit built in sounds to produce your own original creations. Up to 10 of your own sounds can be stored in memory for recall just like the built-in tones.

❑ **General MIDI compatibility**

The General MIDI tones of this keyboard let you connect to a personal computer to enjoy “desktop music” capabilities. This keyboard can be used as a desktop music input device or sound source, and it's just the thing for playback of commercially available pre-recorded General MIDI music software.

❑ **Powerful effects**

A collection of powerful effects, such as reverb, chorus, and more, give you total control over the type of sound you want. You can even change the parameters of an effect to create your own, original effects. A 4-band equalizer is also included.

❑ **Mixer**

You can specify tone, volume, pan position, and other parameters for each built-in Auto Accompaniment part. You can also control the same parameters for each channel during MIDI input.

❑ **Registration Memory**

Keyboard setups can be stored in memory for later recall and instant settings whenever you need them. Up to 16 setups (4 setups x 4 banks) can be stored in registration memory.

❑ **Data download from your computer**

You can use your computer to download data from the CASIO MUSIC SITE.



Safety Precautions

Symbols

Various symbols are used in this user's guide and on the product itself to ensure that the product is used safely and correctly, and to prevent injury to the user and other persons as well as damage to property. Those symbols along with their meanings are shown below.

DANGER

This symbol indicates information that, if ignored or applied incorrectly, creates the danger of death or serious personal injury.

WARNING

This indication stipulates matters that have the risk of causing death or serious injury if the product is operated incorrectly while ignoring this indication.

CAUTION

This indication stipulates matters that have the risk of causing injury as well as matters for which there is the likelihood of occurrence of physical damage only if the product is operated incorrectly while ignoring this indication.

Symbol Examples



This triangle symbol (\triangle) means that the user should be careful. (The example at left indicates electrical shock caution.)



This circle with a line through it (\otimes) means that the indicated action must not be performed. Indications within or nearby this symbol are specifically prohibited. (The example at left indicates that disassembly is prohibited.)



The black dot (\bullet) means that the indicated action must be performed. Indications within this symbol are actions that are specifically instructed to be performed. (The example at left indicates that the power plug must be unplugged from the electrical socket.)

DANGER

Alkaline Batteries

Perform the following steps immediately if fluid leaking from alkaline batteries ever gets into your eyes.



1. Do not rub your eyes! Rinse them with water.
2. Contact your physician immediately.

Leaving alkaline battery fluid in your eyes can lead to loss of sight.

WARNING

Smoke, Strange Odor, Overheating

Continued use of the product while it is emitting smoke, a strange odor, or heat creates the risk of fire and electric shock. Take the following steps immediately.

1. Turn off power.
2. If you are using the AC adaptor for power, unplug it from the wall outlet.
3. Contact your original retailer or an authorized CASIO Service Provider.

AC Adaptor

Misuse of the AC adaptor creates the risk of fire and electric shock. Always make sure you observe the following precautions.

- Be sure to use only the AC adaptor that is specified for this product.
- Use only a power source whose voltage is within the rating marked on the AC adaptor.
- Do not overload electrical outlets and extension cords.



AC Adaptor

Misuse of the AC adaptor's electric cord can damage or break it, creating the risk of fire and electric shock. Always make sure you observe the following precautions.

- Never place heavy objects on the cord or subject it to heat.
- Never try to modify the cord or subject it to excessive bending.
- Never twist or stretch the cord.
- Should the electric cord or plug become damaged, contact your original retailer or authorized CASIO Service Provider.



AC Adaptor

Never touch the AC adapter while your hands are wet.

Doing so creates the risk of electric shock.



Batteries

Misuse of batteries can cause them to leak, resulting in damage to nearby objects, or to explode, creating the risk of fire and personal injury. Always make sure you observe the following precautions.

- Never try to take batteries apart or allow them to become shorted.
- Never expose batteries to heat or dispose of them by incineration.
- Never mix old batteries with new ones.
- Never mix batteries of different types.
- Do not charge the batteries.
- Make sure the positive (+) and negative (-) ends of the batteries are facing correctly.



Do not incinerate the product.

Never throw the product into fire. Doing so can cause it to explode, creating the risk of fire and personal injury.



Water and Foreign Matter

Water, other liquids, and foreign matter (such as pieces of metal) getting into the product create the risk of fire and electric shock. Take the following steps immediately.



1. Turn off power.
2. If you are using the AC adaptor for power, unplug it from the wall outlet.
3. Contact your original retailer or an authorized CASIO Service Provider.

Disassembly and Modification

Never try to take this product apart or modify it in any way. Doing so creates the risk of electric shock, burn injury, or other personal injury. Leave all internal inspection, adjustment, and maintenance up to your original retailer or authorized CASIO Service Provider.



Dropping and Impact

Continued use of this product after it has been damaged by dropping or subjecting it to strong impact creates the risk of fire and electric shock. Take the following steps immediately.

1. Turn off power.
2. If you are using the AC adaptor for power, unplug it from the wall outlet.
3. Contact your original retailer or an authorized CASIO Service Provider.



Plastic Bags

Never place the plastic bag the product comes in over your head or in your mouth. Doing so creates the risk of suffocation.



Particular care concerning this precaution is required where small children are present.

Keep off of the product and stand.*

Climbing onto the product or stand can cause it to tip over or become damaged. Particular care concerning this precaution is required where small children are present.



Location

Avoid locating the product on an unstable stand, on an uneven surface, or any other unstable location. An unstable location can cause the product to fall over, creating the risk of personal injury.



CAUTION

AC Adaptor

Misuse of the AC adaptor creates the risk of fire and electric shock. Always make sure you observe the following precautions.

- Do not locate the electric cord near a stove or other sources of heat. 
- Never pull on the cord when unplugging from the electrical outlet. Always grasp the AC adaptor when unplugging.

AC Adaptor

Misuse of the AC adaptor creates the risk of fire and electric shock. Always make sure you observe the following precautions.

- Insert the AC adaptor into the wall outlet as far as it will go. 
- Unplug the AC adaptor from the wall outlet during lightning storms or before leaving on a trip or other long-term absence.
- At least once a year, unplug the AC Adaptor from the wall outlet and wipe away any dust that is built up in the area around the prongs of the plug.

Relocating the Product

Before relocating the product, always unplug the AC adaptor from the wall outlet and disconnect all other cables and connecting cords. Leaving cords connected creates the risk of damage to the cords, fire, and electric shock. 

Cleaning

Before cleaning the product, always unplug the AC adaptor from the wall outlet first. Leaving the AC adaptor plugged in creates the risk of damage to the AC adaptor, fire, and electric shock. 

Batteries

Misuse of batteries can cause them to leak resulting in damage to nearby objects, or to explode, creating the risk of fire and personal injury. Always make sure you observe the following precautions.

- Use only batteries that are specified for use with this product. 
- Remove batteries from the product if you do not plan to use it for a long time.

Connectors

Connect only the specified devices and equipment to the product's connectors. Connection of a non-specified device or equipment creates the risk of fire and electric shock. 

Location

Avoid the following locations for this product. Such locations create the risk of fire and electric shock. 

- Areas subject to high humidity or large amounts of dust
- In food preparation areas or other areas subject to oil smoke
- Near air conditioning equipment, on a heated carpet, in areas exposed to direct sunlight, inside of a vehicle parked in the sun, or any other area that subjects the product to high temperatures

Display Screen

- Never push on the display screen's LCD panel or subject it to strong impact. Doing so can cause the LCD panel's glass to crack, creating the risk of personal injury. 
- Should the LCD panel ever crack or break, never touch the liquid inside of the panel. LCD panel liquid can cause skin irritation.
- Should LCD panel liquid ever get inside your mouth, immediately wash out your mouth with water and contact your physician.
- Should LCD panel liquid ever get into your eyes or onto your skin, rinse with clear water for at least 15 minutes, and then contact a physician.

Sound Volume

Do not listen to music at very loud volumes for long periods. Particular care concerning this precaution is required when using headphones. High volume settings can damage your hearing. 

Heavy Objects

Never place heavy object on top of the product.  Doing so can make the product top heavy, causing the product to tip over or the object to fall from it, creating the risk of personal injury.

Correct Stand* Assembly

An incorrectly assembled stand can tip over, causing the product to fall and creating the risk of personal injury. 

Make sure you assemble the stand correctly, following the assembly instructions that come with it. Make sure you mount the product on the stand correctly.

* Stand is available as an option.

IMPORTANT!

When using batteries, be sure to replace them or shift to one of the alternate power sources whenever you notice any of the following symptoms.

- Dim power indicator
- Instrument does not turn on
- Display that is flickering, dim, or difficult to read
- Abnormally low speaker/headphone volume
- Distortion of sound output
- Occasional interruption of sound when playing at high volumes
- Sudden power failure when playing at high volumes
- Flickering or dimming of the display when playing at high volume
- Continued sound output even after you release a key
- A tone that is totally different from the one that is selected
- Abnormal rhythm pattern and demo tune play
- Loss of power, sound distortion, or low volume when playing from a connected computer or MIDI device



Care of your Instrument

Avoid heat, humidity or direct sunlight.

Do not overexpose the instrument to direct sunlight, or place it near an air conditioner, or in any extremely hot place.

Do not use near a TV or radio.

This instrument can cause video or audio interference with TV and radio reception. If this happens, move the instrument away from the TV or radio.

Do not use lacquer, thinner or similar chemicals for cleaning.

Clean the instrument with a soft cloth dampened in a weak solution of water and a neutral detergent. Soak the cloth in the solution and squeeze until it is almost dry.

Avoid use in areas subjected to temperature extremes.

Extremely high or low temperature can cause figures on the LCD screen to become dim and difficult to read. This condition should correct itself when the instrument is brought back to normal temperature.

NOTE

- You may notice lines in the finish of the case of this instrument. These lines are a result of the molding process used to shape the plastic of the case. They are not cracks or breaks in the plastic, and are no cause for concern.



Contents

Welcome..... E-1

Introduction E-2

Safety Precautions E-4

Care of your keyboard E-9

Contents E-10

General Guide E-12

About the display E-14

Playing a Demo Tune E-15

Power Supply..... E-16

Using batteries E-16

Using the AC Adaptor E-17

Auto Power Off E-17

Memory Contents E-18

Connections..... E-19

Basic Operations E-21

To play the keyboard E-21

Selecting a Tone E-21

Using an Advanced Tone E-22

Applying Effects to Tones ... E-23

Effect Blocks E-23

Selecting REVERB and CHORUS E-23

Selecting a DSP type E-25

Using the Equalizer E-27

Auto Accompaniment E-28

Selecting a Rhythm E-28

Playing a Rhythm E-28

Adjusting the Tempo E-28

Using Auto Accompaniment E-29

Using an Intro Pattern E-31

Using a Fill-in Pattern E-32

Using a Rhythm Variation E-32

Synchro Starting Accompaniment
with Rhythm Play E-32

Finishing with an Ending Pattern E-33

Using One-touch Preset E-33

Using Auto Harmonize E-33

Adjusting the Accompaniment Volume E-34

Mixer Function E-35

What you can do with the Mixer E-35

Turning Channels On and Off E-35

Using the Parameter Edit Mode E-36

How Parameters Work E-37

Synthesizer Mode E-38

Synthesizer Mode Functions E-38

Creating a User Tone E-40

Storing a User Tone In Memory E-42

Registration Memory E-44

Registration Memory Features E-44

To Save a Setup in Registration Memory ... E-45

To Recall a Setup from Registration

Memory E-45

Song Memory Function E-46

Tracks	E-46
Basic Song Memory operations	E-46
Using Real-time Recording	E-47
Mixer Mode Settings	E-48
Playing Back from Song Memory	E-49
Recording Melody and Chords with Step Recording	E-49
Recording Multiple Tracks	E-52
Correcting Mistakes While Step Recording	E-54
Editing Memory Contents	E-55
Editing a Song	E-57

Keyboard Settings E-59

Using Layer	E-59
Using Split	E-59
Using Layer and Split Together	E-60
Using Touch Response	E-61
Transposing the Keyboard	E-62
Tuning the Keyboard	E-62
Changing Other Settings	E-63

MIDI E-66

What is MIDI?	E-66
General MIDI	E-66
Sending and Receiving MIDI Messages	E-67
MIDI Settings	E-67
Using the Data Download Service	E-68

Troubleshooting E-69

Specifications E-71

Appendix A-1

Tone list	A-1
Drum Assignment List	A-8
Fingered Chord Chart	A-9
Effect List	A-10
DSP Algorithm List	A-12

MIDI Implementation Chart

General Guide

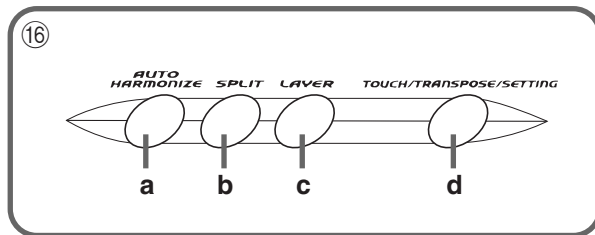
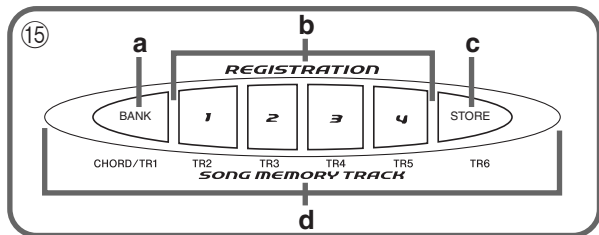
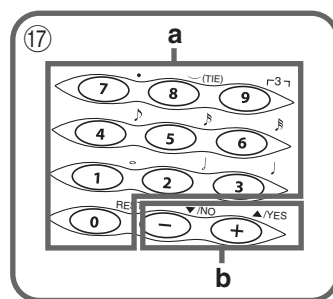
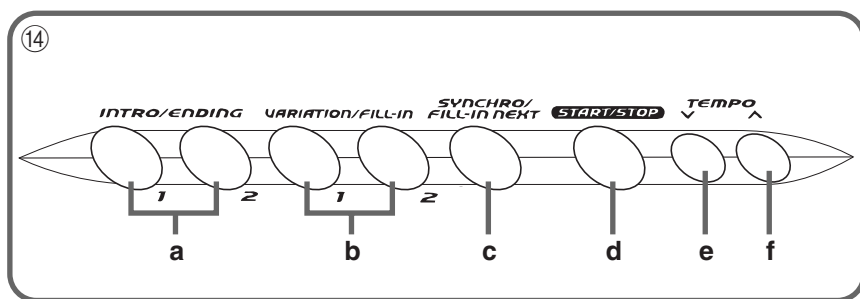
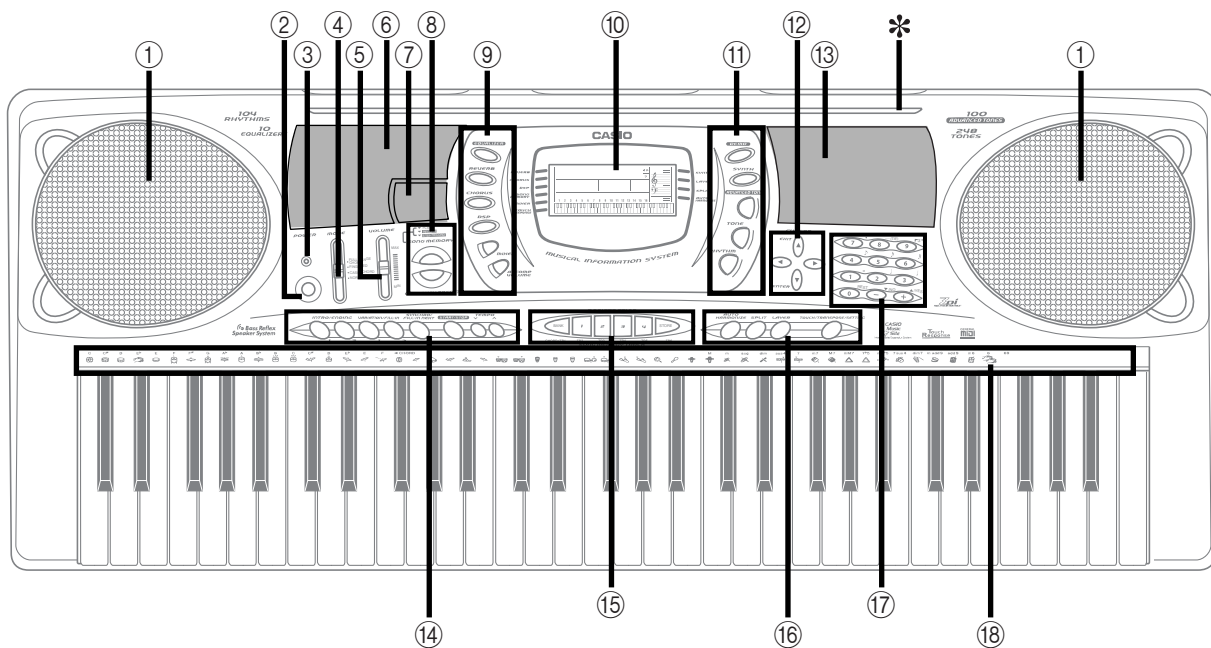
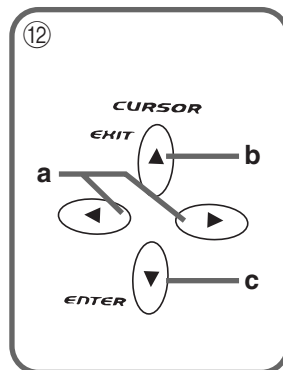
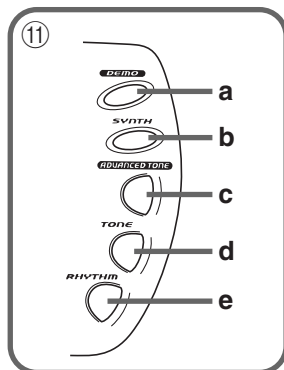
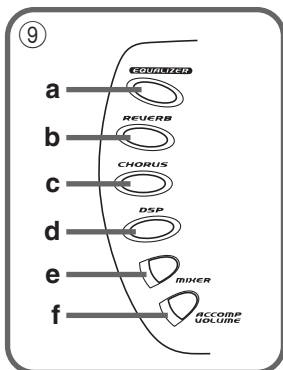
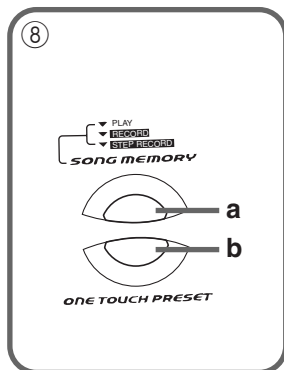

• Key, button, and other names are indicated in the text of this manual using bold type.

- ① Speaker
- ② POWER button
- ③ Power indicator
- ④ MODE switch
- ⑤ VOLUME slider
- ⑥ Rhythm list
- ⑦ Equalizer list
- ⑧ a) SONG MEMORY button
b) ONE TOUCH PRESET button
- ⑨ a) EQUALIZER button
b) REVERB button
c) CHORUS button
d) DSP button
e) MIXER button
f) ACCOMP VOLUME button
- ⑩ Display
- ⑪ a) DEMO button
b) SYNTH button
c) ADVANCED TONE button
d) TONE button
e) RHYTHM button
- ⑫ a) [◀] / [▶] CURSOR buttons
b) [▲] EXIT button
c) [▼] ENTER button
- ⑬ Tone list
- ⑭ a) INTRO/ENDING 1/2 buttons
b) VARIATION/FILL-IN 1/2 buttons
c) SYNCHRO/FILL-IN NEXT button
d) START/STOP button
e) TEMPO buttons
- ⑮ a) BANK button
b) REGISTRATION buttons
c) STORE button
d) SONG MEMORY TRACK buttons
- ⑯ a) AUTO HARMONIZE button
b) SPLIT button
c) LAYER button
d) TOUCH/TRANPOSE/SETTING button
- ⑰ a) Number buttons
 - For input of numbers to change displayed settings.
 b) [+]/[-] buttons (YES/NO)
 - Negative values can be changed only by using [+] and [-] to increment and decrement the displayed value.
- ⑱ a) CHORD root names
b) Chord types name
c) Percussion instrument list
- ⑲ MIDI OUT terminal
- ⑳ MIDI IN terminal
- ㉑ SUSTAIN/ASSIGNABLE JACK terminal
- ㉒ PHONES/OUTPUT terminal
- ㉓ DC 9V jack

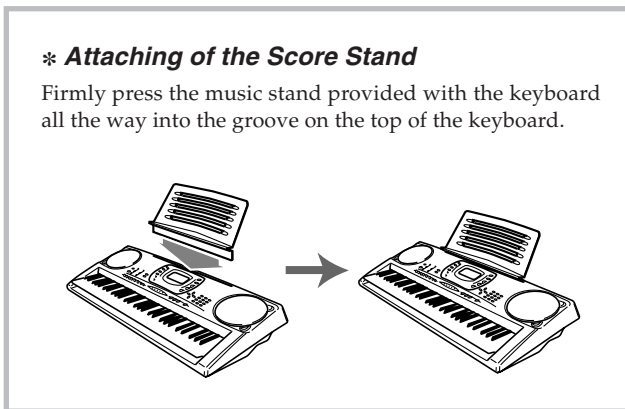
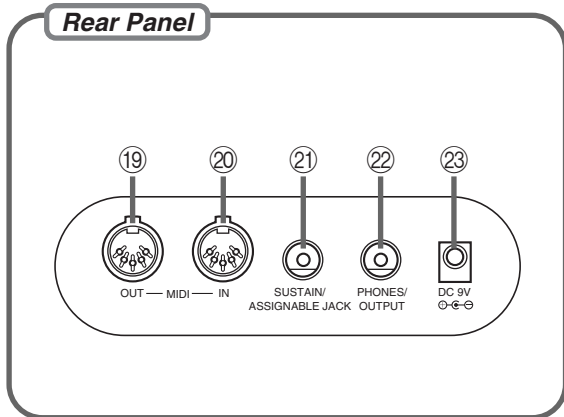
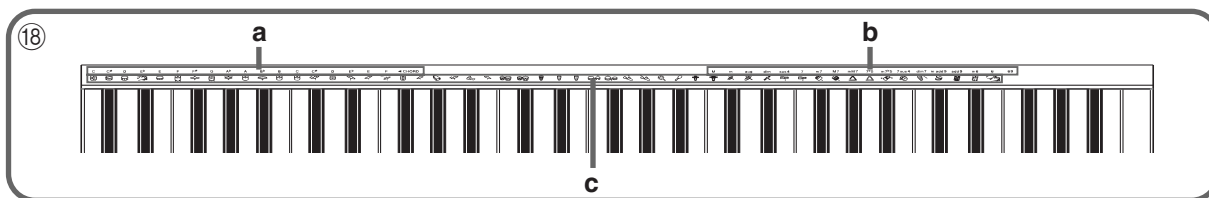

About the display

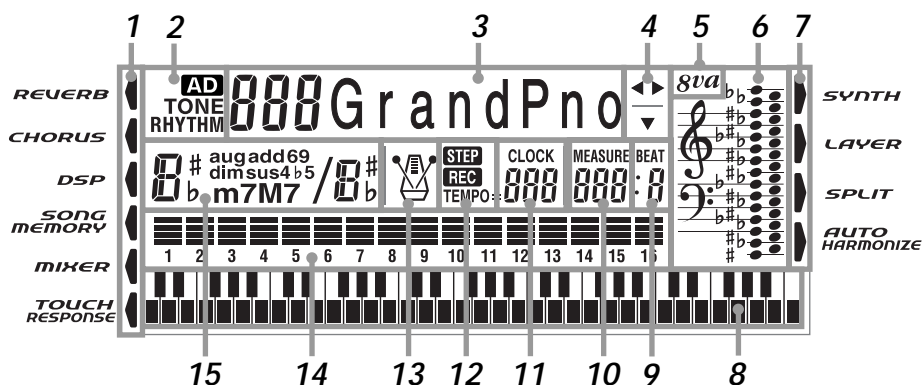

1. Indicators appear here to show when reverb, chorus, DSP, the Mixer Mode, Song Memory, or Touch Response is being used.
2. The TONE indicator appears when you are selecting or viewing the TONE setting, while RHYTHM appears for the RHYTHM setting. The AD and TONE indicators both appear when you are selecting or viewing an Advanced Tone.
 - “AD TONE” stands for “ADVANCED TONE.”
3. Tone number/Tone name
 - The tone number/ tone name area is also used to indicate the rhythm number and rhythm name, and to indicate various functions in the Synthesizer Mode, Mixer Mode, Registration Mode, and Song Memory Mode.
4. Indicated keys are those that are operational for the function you are currently performing.
5. Octave Symbol
Appears when the note produced by the keyboard is one octave higher than the note indicated on the staff.
6. Notes you play on the keyboard, notes being played back from Song Memory, chord forms, and received MIDI data* are shown in the staff on the display.
7. Indicators appear here to show when the synthesizer, layer, split, or auto harmonize is being used.
8. This display shows the note played on the keyboard, notes being played back from Song Memory, chord forms, and received MIDI data*.
9. The beat number is indicated while a rhythm, Auto-accompaniment, or Song Memory Mode is being used.
10. The measure number is indicated while a rhythm, Auto-accompaniment, or Song Memory Mode is being used.

- 
11. The number of beats per minute are indicated while a rhythm, Auto-accompaniment, or Song Memory Mode is being used.
 - The tempo area is also used to indicate the Song Memory function's clock.
 12. REC flashes on the display during Song Memory record standby. REC remains on the display without flashing while recording is in progress. STEP is displayed during step recording.
 13. You can turn on the metronome to provide a reference beat for your keyboard play.
 14. Level Meter
The velocity of each channel is indicated as one of three levels. This display also shows the Mixer channel's on/off status.
 15. The name of the chord being played is shown on the display while Auto Accompaniment is being used.

* These items do not appear when a note outside the display range (C2 to C7) is received.

NOTE

- Display examples shown in this User's Guide are intended for illustrative purposes only. The actual text and values that appear on the display may differ from the examples shown in this User's Guide.



Playing a Demo Tune

Pressing the DEMO button starts demo tune play. There are two demo tunes, which continuously play in sequence. To stop demo tune play, press either the DEMO button or the START/STOP button.

NOTE

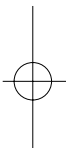
- Pressing the [+]/[-] buttons skips to the next demo tune.
 - MIDI, Layer, and Split are disabled while a demo tune is playing.
- 

Power Supply

This keyboard can be powered by current from a standard household wall outlet (using the specified AC adaptor) or by batteries. Always make sure you turn the keyboard off whenever you are not using it.

Using batteries

Always make sure you turn off the keyboard before loading or replacing batteries.

To load batteries

1. Remove the battery compartment cover.

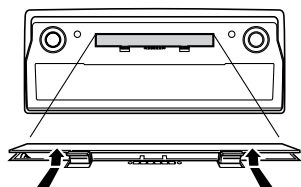

2. Load six D-size batteries into the battery compartment.

- Make sure that the positive (+) and negative (-) ends are facing correctly.

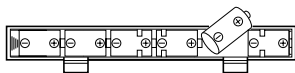

3. Insert the tabs on the battery compartment cover into the holes provided and close the cover.

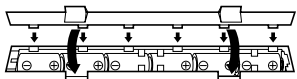

The keyboard may not function correctly if you load or replace batteries with power turned on. If this happens, turning the keyboard off and then back on again should return functions back to normal.

Important Battery Information

- The following shows the approximate battery life.
 - Manganese batteries Approximately 4 hoursThe above value is standard battery life at normal temperature, with the keyboard volume at a medium setting. Temperature extremes or playing at very loud volume settings can shorten battery life.
- Any of the following symptoms indicate low battery power. Replace batteries as soon as possible whenever any of the following occurs.
 - Dim power indicator
 - Instrument does not turn on
 - Display that is flickering, dim, or difficult to read
 - Abnormally low speaker/headphone volume
 - Distortion of sound output
 - Occasional interruption of sound when playing at high volumes
 - Sudden power failure when playing at high volumes
 - Flickering or dimming of the display when playing at high volume
 - Continued sound output even after you release a key
 - A tone that is totally different from the one that is selected.
 - Abnormal rhythm pattern and demo tune play
 - Loss of power, sound distortion, or low volume when playing from a connected computer or MIDI device

IMPORTANT!

Improper handling of batteries can cause them to burst and leak, which creates the danger of personal injury or damage due to contact with battery acid. Be sure to note the following important precautions.

- Always make sure that the positive (+) and negative (-) poles are facing correctly as indicated near the battery compartment.
- To avoid damage caused by leaking batteries, be sure to remove batteries from the keyboard whenever you leave it unattended for long periods (such as when leaving on a trip).
- Never mix batteries of different types.
- Never mix old batteries with new ones.
- Never discard batteries by incinerating them, do not allow their poles to be shorted (connected to each other), never take batteries apart, and do not expose batteries to direct heat.
- Replace batteries as soon as possible after any sign they are getting weak.
- Never attempt to recharge batteries.

Using the AC Adaptor

Make sure that you use only the AC adaptor specified for this keyboard.

Specified AC Adaptor: AD-5

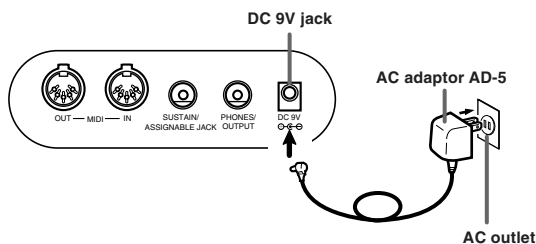

Also note the following important warnings and precautions when using the AC adaptor.

WARNING!

- Take care to avoid any damage to or breakage of the power cord. Never place any heavy objects on the power cord or expose it to direct heat. Doing so creates the danger of power cord damage, fire, and electrical shock.
- Use only the specified AC adaptor. Use of another type of adaptor creates the danger of fire and electrical shock.

CAUTION!

- For safety sake, be sure to unplug the AC adaptor from the wall outlet whenever leaving the keyboard unattended for a long time (such as when leaving on a trip).
- Always turn off the keyboard and unplug the AC adaptor from the wall outlet when you are not using the keyboard.

IMPORTANT!

- Make sure that the keyboard is turned off before connecting or disconnecting the AC adaptor.
- Using the AC adaptor for a long time can cause it to become warm to the touch. This is normal and does not indicate malfunction.

Auto Power Off

When you are using battery power, keyboard power turns off automatically whenever you leave it on without performing any operation for about 6 minutes. When this happens, press the POWER button to turn power back on.

NOTE

- Auto Power Off is disabled (it does not function) when you are using the AC adaptor to power the keyboard.

To disable Auto Power Off

Hold down the TONE button while turning on the keyboard to disable Auto Power Off.

- When Auto Power Off is disabled, the keyboard does not turn off automatically no matter how long it is left with no operation being performed.
- Auto Power Off is automatically enabled whenever you turn on keyboard power.

Settings

Tone, rhythm, and other “main keyboard settings” in effect when you turn off the keyboard manually by pressing POWER or when Auto Power Off turns off power are still in effect the next time you turn power back on.

Main Keyboard Settings

Tone number, layer, split, split point, touch response, reverb, chorus, DSP, equalizer, rhythm number, tempo, Mixer Mode settings (channel on/off, tone number, volume, pan pot), keyboard channel, MIDI In Chord Judge on/off, accomp MIDI out on/off, assignable jack setting, accompaniment volume, user area tones (Synthesizer Mode), user area accompaniments, user area DSP

Memory Contents

In addition to the above settings, data stored in the Registration Mode and Song Memory Mode is also retained when keyboard power is turned off.

Electrical Power

The settings and memory data described above are retained as long as the keyboard is being supplied with electrical power. Unplugging the AC adaptor when batteries are not loaded or when loaded batteries are dead cuts off the keyboard's electrical power supply. This causes all settings to be initialized to their factory defaults and clears all data stored in memory.

Power Requirements

Note the following precautions whenever you want to ensure that current keyboard settings and memory contents are not lost.

- Make sure the keyboard is being supplied power through the AC adaptor before replacing its batteries.
- Before unplugging the AC adaptor, make sure that fresh batteries are loaded in the keyboard.
- Make sure that keyboard power is turned off before replacing batteries or unplugging the AC adaptor.

Initializing the Keyboard

Use the procedure on page E-65 to initialize the keyboard, which clears all memory data and returns settings to their initial factory defaults.

Connections

Phones/Output Terminal

Before connecting phones or other external equipment, be sure to first turn down the volume settings of the keyboard and the connected equipment. You can then adjust volume to the desired level after connections are complete.

Rear Panel

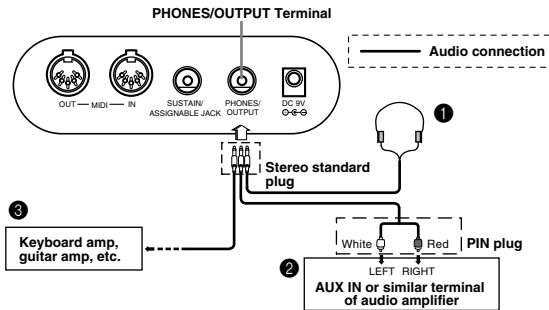

Connecting Phones ❶

Connecting phones cuts off output from the keyboard's built-in speakers, so you can play even late at night without disturbing anyone.

Audio Equipment ❷

Connect the keyboard to a audio equipment using a commercially available connecting cord with a standard plug on one end and two PIN plugs on the other end. Note that the standard plug you connect to the keyboard must be a stereo plug, otherwise you will be able to output only one of stereo channels. In this configuration, you normally set the input selector of the audio equipment to the terminal (usually marked AUX IN or something similar) where the cord from the keyboard is connected. See the user documentation that comes with your audio equipment for full details.

Musical Instrument Amplifier ❸

Use a commercially available connecting cord to connect the keyboard to a musical instrument amplifier.

NOTE

- Be sure to use a connecting cord that has a stereo standard plug on the end you connect to the keyboard, and a connector that provides dual channel (left and right) input to the amplifier to which you are connecting. The wrong type of connector at either end can cause one of the stereo channels to be lost.

When connected to a musical instrument amplifier, set the volume of the keyboard to a relatively low level and make output volume adjustments using the amplifier's controls.

Connection Example

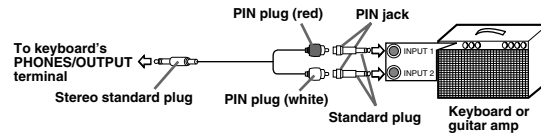

NOTE

- You can also connect the keyboard to a computer or sequencer. See "MIDI" on page E-66 for details.

Sustain/Assignable jack Terminal

You can connect an optional sustain pedal (SP-2 or SP-10) to the SUSTAIN/ASSIGNABLE JACK terminal to enable the capabilities described below.

For details on how to select the pedal function you want, see “Changing Other Settings” on page E-63.

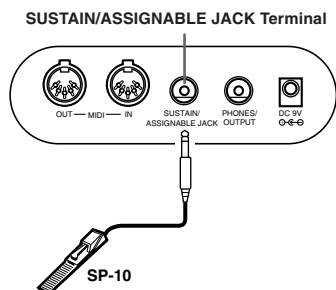

Sustain Pedal

- With piano tones, depressing the pedal causes notes to linger, much like a piano’s damper pedal.
- With organ tones, depressing the pedal causes notes to continue to sound until the pedal is released.

Sostenuto Pedal

- As with the sustain pedal function described above, depressing the sostenuto pedal causes notes to be sustained.
- This difference between a sostenuto pedal and sustain pedal is the timing. With a sostenuto pedal, you press the keys and then depress the pedal before you release the keys. Only the notes that are sounding when the pedal is depressed are sustained.

Soft Pedal

Depressing the pedal softens the sound of the notes being played.

Rhythm Start/Stop Pedal

In this case, the pedal performs the same functions as the START/STOP button.

Accessories and Options

Use only the accessories and options specified for this keyboard. Use of non-authorized items creates the danger of fire, electrical shock, and personal injury.

Basic Operations

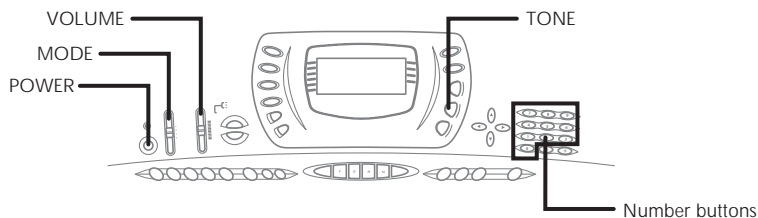

This section provides information on performing basic keyboard operations.

To play the keyboard

1. Press the **POWER** button to turn the keyboard on.
2. Set the **MODE** switch to **NORMAL**.
3. Use the **VOLUME** slider to set the volume to a relatively low level.
4. Play something on the keyboard.

Selecting a Tone

This keyboard comes with 348 built-in tones. Use the following procedure to select the tone you want to use.

To select a tone

1. Find the tone you want to use in the keyboard's tone list and note its tone number.
2. Press the **TONE** button.

TONE 000 GrandPno

3. Use the number buttons to input the three digit tone number for the tone you want to select.

Example: To select "039 ACOUSTIC BASS", input 0, 3 and then 9.

TONE 039 Aco . Bass

NOTE

- Always input all three digits for the tone number, including leading zeros (if any).
- You can also increment the displayed tone number by pressing [+] and decrement it by pressing [-].
- When one of the drum sets is selected (tone numbers 228 through 237), each keyboard key is assigned a different percussion sound. See page A-8 for details.
- The names of tone number 100 through 227 are not marked on the keyboard console. Refer to the "Tone List" at the back of this User's Guide when selecting a tone within this range.

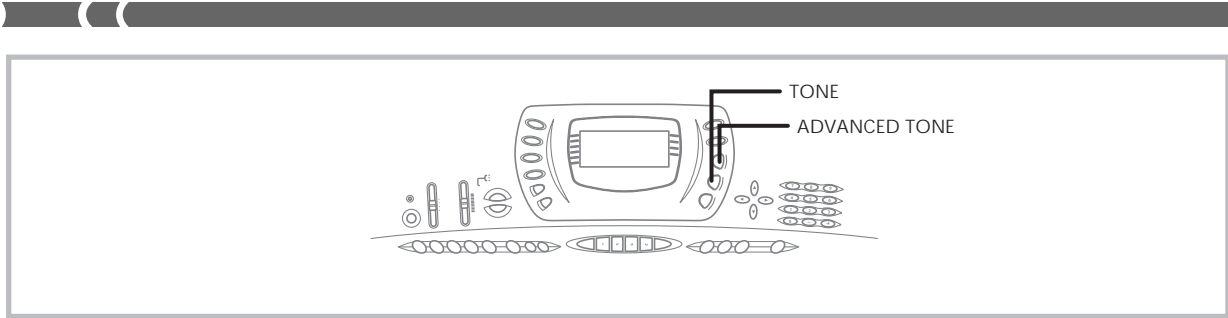

Using an Advanced Tone

100 of the preset tones are “Advanced Tones,” which are variations of standard tones created by programming in effects (DSP) and other settings. For example, PIANO is modified into STEREO PIANO, ORGAN becomes ROTARY SPEAKER ORGAN, and so on.

To select an Advanced Tone

1. Press the **ADVANCED TONE** button.
 - This causes “AD” to appear on the display, and causes the currently selected tone to change to its Advanced Tone version.



- “AD TONE” stands for “ADVANCED TONE.”

2. Press the **TONE** button.
 - This causes “AD” to disappear from the display, and returns to the tone to its standard preset.

NOTE

- Preset tone numbers 000 to 099 have Advanced Tone versions.
- Anytime “AD” is on the display indicating that an Advanced Tone is selected, you can use [+] and [-] to scroll the tone number on the display.
- If any tone number outside the range of 000 to 099 is selected when you press the **ADVANCED TONE** button, the tone automatically changes to the Advanced Tone version of tone number 00.
- Only one of the channels (1 to 16) can have an Advanced Tone assigned to it at one time. Assigning an Advanced Tone to another channel causes the currently assigned channel to change automatically to its standard (non-Advanced) version.

Polyphony

The term polyphony refers to the maximum number of notes you can play at the same time. The keyboard has 32-note polyphony, which includes the notes you play as well as the rhythms and auto-accompaniment patterns that are played by the keyboard. This means that when a rhythm or auto-accompaniment pattern is being played by the keyboard, the number of notes (polyphony) available for keyboard play is reduced. Also note that some of the tones offer only 16-note polyphony.

Digital Sampling

A number of the tones that are available with this keyboard have been recorded and processed using a technique called digital sampling. To ensure a high level of tonal quality, samples are taken in the low, mid, and high ranges and then combined to provide you with sounds that are amazingly close to the originals. You may notice very slight differences in volume or sound quality for some tones when you play them at different positions on the keyboard. This is an unavoidable result of multiple sampling, and it is not a sign of malfunction.

Applying Effects to Tones

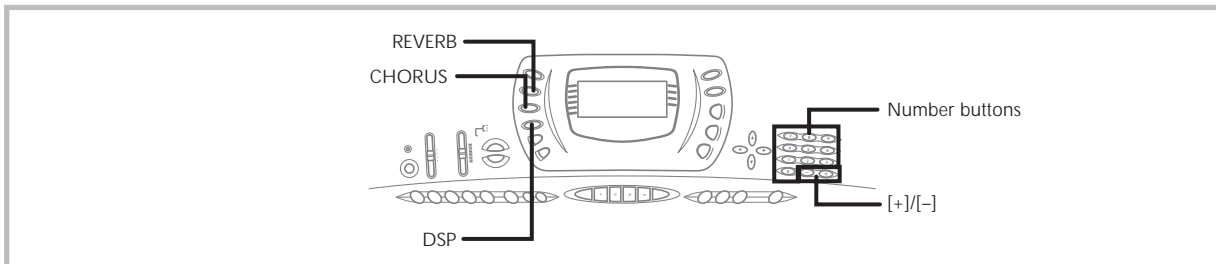

This keyboard provides you with a selection of effects that you can apply to tones. The built-in effects include a wide variety of variations that give you access to a selection of general digital effects.

Effect Blocks

The following shows how the effects of this keyboard are organized.

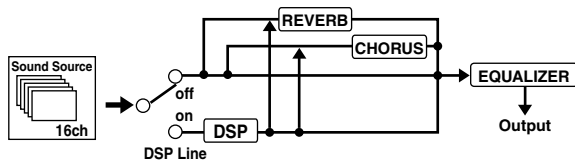

REVERB

Reverb simulates the acoustics of specific types of environments. You can choose from among 16 different reverb effects, including "Room" and "Hall."

CHORUS

The chorus effect gives sound greater depth by causing it to vibrate. You can choose from among 16 different chorus effects, including "Chorus" and "Flanger."

DSP

DSP effects are applied to the connection between the sound source and output. You can select distortion and modulation effects. You can create DSP effect setups and also transfer downloaded DSP data from your computer. The keyboard has memory for up to 10 DSP effect setups, which you can store. See "Using the Data Download Service" on page E-68 and "Saving the Settings of DSP Parameters" on page E-26 for more information.

Selecting REVERB and CHORUS

Perform the following steps to select REVERB or CHORUS.

1. Press the button (REVERB or CHORUS) for the effect you want to select, so the button's indicator is shown on the display screen.
 - An indicator is on the display next to REVERB or CHORUS when the effect is turned on. The indicator is not displayed when the corresponding effect is turned off.

Example: Indicator after the REVERB button is pressed



2. Use the [+] and [-] buttons or the number buttons to scroll through the effects until the one you want is displayed, or use the number buttons to input the effect number you want to select.
 - See the list on page A-10 for information about the types of CHORUS and REVERB effects that are available.
 - Here you could also change the parameters of the effect you selected, if you want. See "Changing the Settings of REVERB and CHORUS Parameters" for more information.

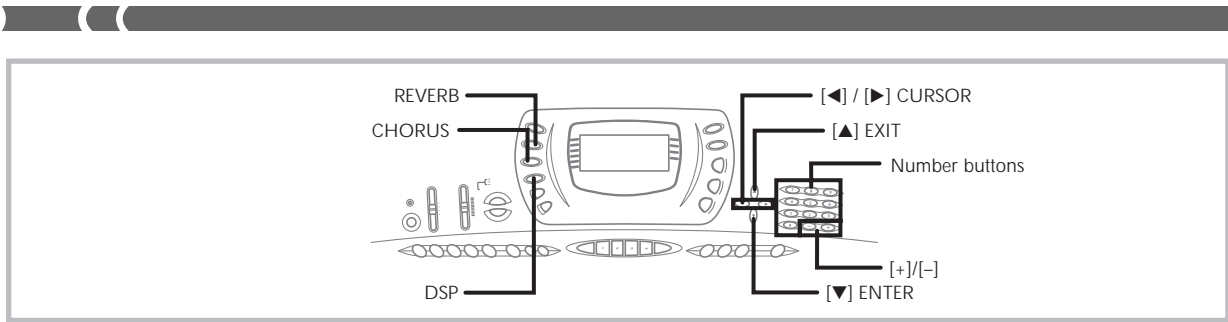

Changing the Settings of REVERB and CHORUS Parameters

You can control the relative strength of an effect and how it is applied. The parameters you can control depend on the effect. See the following section titled “REVERB and CHORUS Parameters” for more information.

1. After selecting the effect you want, press the [▼] (ENTER) button.
 - This displays the parameter setting screen.
2. Use the [◀] and [▶] (CURSOR) buttons to display the parameter whose setting you want to change.

Example: To set the Reverb Time parameter



3. Use the [+] and [-] buttons or the number buttons to input the parameter setting you want.
4. Press the [▲] (EXIT) button.
 - This returns to the effect selection screen.

REVERB and CHORUS Parameters

The following describes the parameters for each effect.

REVERB

Reverb effects are associated with either a reverb type or delay type. Parameter settings depend upon the associated type.

- **Reverb Type (No. 0 to 5, 8 to 13)**
- **Reverb Level (Range: 000 to 127)**
Controls the reverb size. A larger number produces larger reverb.
- **Reverb Time (Range: 000 to 127)**
Controls how long reverb continues. A larger number produces longer reverb.

- **ER Level (Initial Echo Sound) (Range: 000 to 127)**

This parameter controls the initial reverb volume. The initial echo sound is the first sound reflected from the walls and ceiling when a sound is output by this keyboard. A larger value specifies a larger echo sound.

- **High Damp (Range: 000 to 127)**

Adjusts the damping of high frequency reverberation (high sound). A smaller value damps high sounds, creating a dark reverb. A larger value does not damp high sounds, for a brighter reverb.

- **Delay Type (No. 6, 7, 14, 15)**

- **Delay Level (Range: 000 to 127)**

Specifies the size of the delay sound. A higher value produces a larger delay sound.

- **Delay Feedback (Range: 000 to 127)**

Adjusts delay repeat. A higher value produces a greater number of repeats.

- **ER Level**

Same as Reverb Type

- **High Damp**

Same as Reverb Type

CHORUS

- **Chorus Level (Range: 000 to 127)**

Specifies the size of the chorus sound.

- **Chorus Rate (Range: 000 to 127)**

Specifies the undulation speed of the chorus sound. A higher value produces faster undulation.

- **Chorus Depth (Range: 000 to 127)**

Specifies the undulation depth of the chorus sound. A higher value produces deeper undulation.

NOTE

- Whether or not an effect is applied to the parts that are sounding also depends on Mixer Mode Reverb Send, Chorus Send, and DSP on/off settings. See “Mixer Function” on page E-35 for more information.

Selecting a DSP Type

Perform the following steps to select a DSP type.

1. Press the **DSP** button so the indicator appears next to DSP on the display.
2. Use the **[+]** and **[-]** buttons or number buttons to select the type of DSP you want.
 - See the “Effect List” on page A-10 for information about the DSP types that can be selected.
 - Here you could also change the parameters of the effect you selected, if you want. See “Changing the Settings of DSP Parameters” for more information.

NOTE

- When using a DSP effect, you should use the Mixer to confirm that the DSP lines of the required parts are turned on. See “Mixer Function” on page E-35 for more information.
- The DSP type display area shows the DSP number (000 to 109), Ad (Advance tone), or USr (user tone created using DSP).

Setting Basic DSP Parameters

The following are the basic DSP parameters whose settings you can change.

■ DSP Volume (Range: 000 to 127)

Sets the post-DSP volume.

■ DSP Pan (Range: -64 to 00 to +63)

Sets the post-DSP stereo pan.

■ DSP Hold (Settings: on, oFF)

on: Current DSP line setting is maintained, even when the tone is changed.

- In the case of an Advance tone, however, changing the tone causes all DSP line settings except for those of the selected channel to turn off. See the note on page E-26 for more information.

oFF: Changing the tone switches to the DSP line setting of the new tone.

1. Press the **DSP** button so the on-screen DSP indicator appears.
2. Use the **[◀]** and **[▶]** (**CURSOR**) buttons to display the parameter whose setting you want to change.
3. Use the **[+]** and **[-]** buttons or the number buttons to make the parameter setting you want.

4. Press the **[▲]** (**EXIT**) button.

- This exits the tone or rhythm setting screen.

Changing the Settings of DSP Parameters

You can control the relative strength of a DSP and how it is applied. See the following section titled “DSP Parameters” for more information.

1. After selecting the DSP type you want, press the **[▼]** (**ENTER**) button.
 - This displays the parameter setting screen.
2. Use the **[◀]** and **[▶]** (**CURSOR**) buttons to display the parameter whose setting you want to change.
3. Use the **[+]** and **[-]** buttons or the number buttons to make the parameter setting you want.
4. Press the **[▲]** (**EXIT**) button.
 - This exits the DSP type setting screen.

DSP Parameters

The following describes the parameters for each DSP.

DSP

■ Parameter 0 to 7

This parameter differs in accordance with the algorithm* of the selected DSP type. See the “Effect List” on page A-10 and the “DSP Algorithm List” on page A-12 for more information.

* Effector structure and operation type

■ DSP Reverb Send (Range: 000 to 127)

Specifies how much of the post-DSP sound should be sent to reverb.

■ DSP Chorus Send (Range: 000 to 127)

Specifies how much of the post-DSP sound should be sent to chorus.

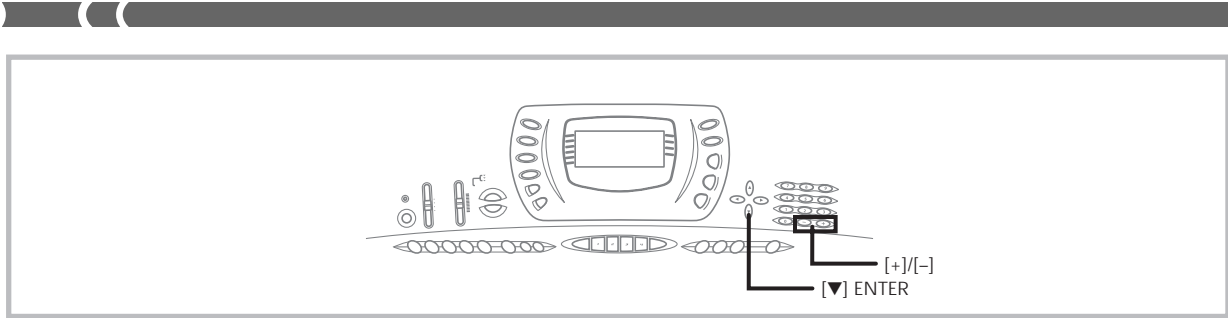

NOTE

- Whether or not an effect is applied to the parts that are sounding also depends on Mixer Mode Reverb Send, Chorus Send, and DSP on/off settings. See “Mixer Function” on page E-35 for more information.
- Playing a demo tune (page E-15) automatically changes the effect to the one that is assigned to the tune. You cannot change or cancel a demo tune effect.
- Changing the effect setting while sound is being output by the keyboard causes a slight break in the sound when the effect changes.
- A number of tones, called “Advanced tones,” automatically turn on the DSP line for more effective tones. If you assign an Advanced tone to a keyboard part (Channels 1 through 4), the DSP line turns on automatically and the DSP selection changes in accordance with the settings of the Advanced tone. Also, the Mixer Mode DSP line on/off setting for the keyboard part to which the Advanced tone is assigned is turned on.*
 - * The Mixer DSP line setting is automatically turned off for each part that does not have an Advanced Tone assigned. Because of this, DSP effects previously applied to these parts are cancelled, which can make their tone sound different. In this case, display the Mixer screen and turn DSP back on.

Saving the Settings of DSP Parameters

You can save up to 10 modified DSPs in the user area for later recall when you need them.

1. After making the DSP parameter settings you want, press the [▼] (ENTER) button.
 - This causes the DSP number of the user area where the DSP will be saved to flash on the display.
2. Use the [+] and [-] buttons to select the user area DSP number where you want to save the new DSP.
 - You can select a user area DSP number in the range of 100 to 109 only.
3. After everything is the way you want, press the [▼] (ENTER) button to store the effect.
 - The message “Save OK” appears momentarily on the display, followed by the tone or rhythm selection screen.

Using the Equalizer

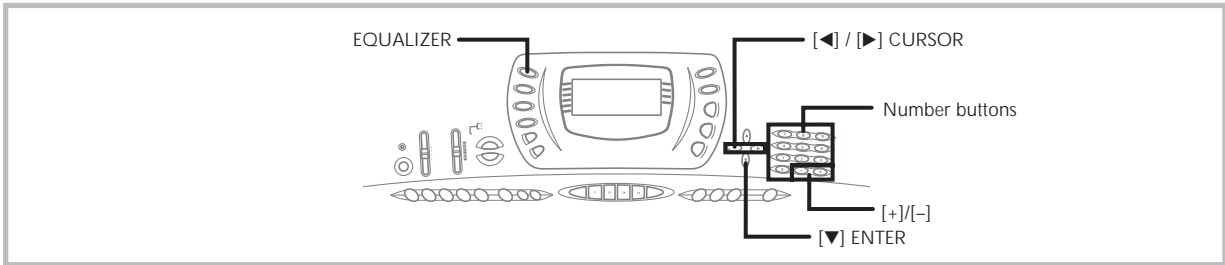

The equalizer is another type of effect that you can use to make adjustments in tone quality. Frequencies are divided among a number of bands, and raising and lowering the level of each frequency band alters the sound. You can reproduce the optimal acoustics for the type of music you are playing (classics, for example) by selecting the applicable equalizer setting. This keyboard has a built-in four-band equalizer and 10 different settings from which you can choose. You can adjust the gain (volume) of all four equalizer bands within the range of -12 to 0 to +12.

To select the equalizer type

1. Press the **EQUALIZER** button.
 - This causes the currently selected equalizer type to appear on the display.



2. Use the **[+]** and **[-]** buttons or the number buttons to select the equalizer type you want.

Example: To select Jazz



- Pressing the **[▲]** (EXIT) button or the **EQUALIZER** button exits the equalizer setting screen.

To adjust the gain (volume) of a band

1. After selecting the equalizer type you want, press the **[▼]** (**ENTER**) button.



2. Use the **[◀]** and **[▶]** (**CURSOR**) buttons to select the band whose gain you want to adjust.

Example: To adjust the HIGH band



3. Use the **[+]** and **[-]** buttons or the number buttons to adjust the band gain.

Example: To adjust the gain to 10



- Pressing the **[▲]** (EXIT) button displays the equalizer type setting screen.
- Pressing the **EQUALIZER** button exits the gain (volume) setting screen.

NOTE

- Changing to another equalizer type causes the band gain settings to change to the initial settings for the newly selected equalizer type automatically.



Auto Accompaniment

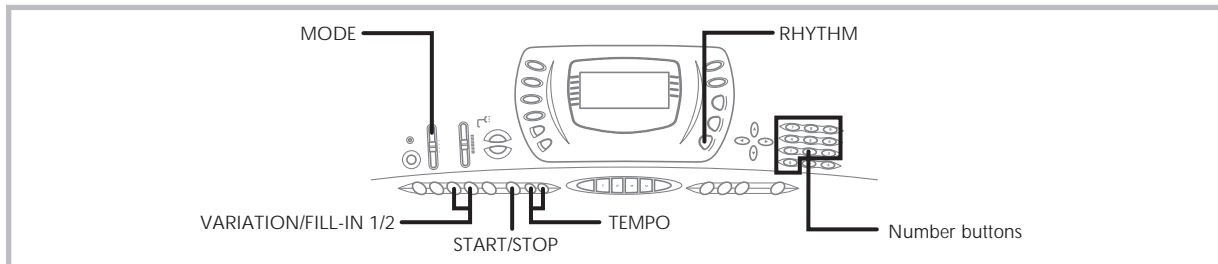

This keyboard automatically plays bass and chord parts in accordance with the chords you finger. The bass and chord parts are played using sounds and tones that are automatically selected to select the rhythm you are using. All of this means that you get full, realistic accompaniments for the melody notes you play with your right hand, creating the mood of a one-person ensemble.

Selecting a Rhythm

This keyboard provides you with 100 exciting rhythms that you can select using the following procedure. You can also transfer accompaniment data from your computer and store up to four of them as user rhythms in keyboard memory. See "Using the Data Download Service" on page E-68 for more information.

To select a rhythm

1. Find the rhythm you want to use in the keyboard's rhythm list and note its rhythm number.
2. Press the **RHYTHM** button.

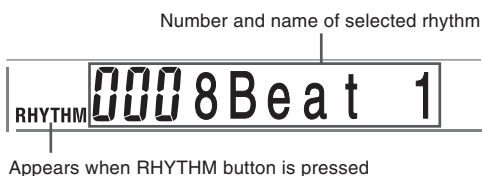

3. Use the number buttons to input the three digit rhythm number for the rhythm you want to select.

Example: To select "031 ROCK", input 0, 3 and then 1.



NOTE

- You can also increment the displayed rhythm number by pressing [+] and decrement it by pressing [-].

Playing a Rhythm

To play a rhythm

1. Set the **MODE** switch to **NORMAL**.
2. Press **VARIATION/FILL-IN** button 1 or 2.
 - This starts the play of the selected rhythm.
 - To stop rhythm play, press the **START/STOP** button.

NOTE

- All of the keyboard keys are melody keys while the **MODE** switch is set to **NORMAL**.

Adjusting the Tempo

You can adjust the tempo of rhythm play within a range of 30 to 255 beats per minute. The tempo setting is used for Auto Accompaniment chord play, and song memory operations.

To adjust the tempo

Press one of the **TEMPO** buttons (▲ or ▼).

- ▲ : Increments displayed value (increases tempo)
- ▼ : Decrements displayed value (decreases tempo)



NOTE

- Pressing both TEMPO buttons (▲ and ▼) at the same time resets the tempo to the default value of the currently selected rhythm.

Using Auto Accompaniment

The following procedure describes how to use the keyboard's Auto Accompaniment feature. Before starting, you should first select the rhythm you want to use and set the tempo of the rhythm to the value you want.

To use Auto Accompaniment

- Set the **MODE** switch to CASIO CHORD, FINGERED, or FULL RANGE CHORD.
- Press the **START/STOP** button to start play of the currently selected rhythm.
- Play a chord.
 - The actual procedure you should use to play a chord depends on the current MODE switch position. Refer to the following pages for details on chord play.

CASIO CHORD This page
 FINGERED Page E-30
 FULL RANGE CHORD Page E-31

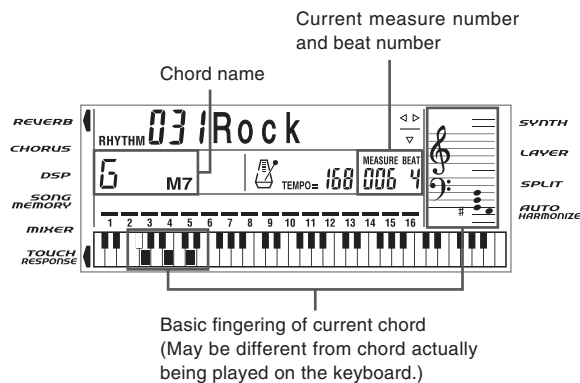

- To stop Auto Accompaniment play, press the **START/STOP** button again.

CASIO CHORD

This method of chord play makes it possible for anyone to easily play chords, regardless of previous musical knowledge and experience. The following describes the CASIO CHORD “accompaniment keyboard” and “melody keyboard,” and tells you how to play CASIO CHORDS.

CASIO CHORD Accompaniment Keyboard and Melody Keyboard

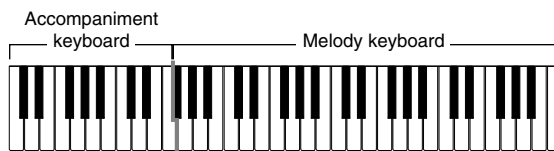

NOTE

- The accompaniment keyboard can be used for playing chords only. No sound will be produced if you try playing single melody notes on the accompaniment keyboard.

Chord Types

CASIO CHORD accompaniment lets you play four types of chords with minimal fingering.

Chord Types	Example
Major chords Major chord names are marked above the keys of the accompaniment keyboard. Note that the chord produced when you press an accompaniment keyboard does not change octave, regardless of which key you use to play it.	C Major (C)
Minor chords (m) To play a minor chord, keep the major chord key depressed and press any other accompaniment keyboard key located to the right of the major chord key.	C minor (Cm)
Seventh chords (7) To play a seventh chord, keep the major chord key depressed and press any other two accompaniment keyboard keys located to the right of the major chord key.	C seventh (C7)
Minor seventh chords (m7) To play a minor seventh chord, keep the major chord key depressed and press any other three accompaniment keyboard keys located to the right of the major chord key.	C minor seventh (Cm7)

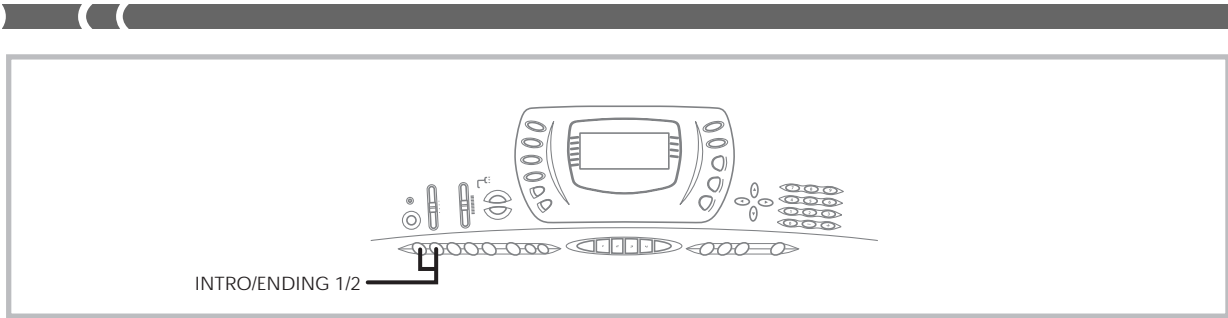

NOTE

- It makes no difference whether you press black or white keys to the right of a major chord key when playing minor and seventh chords.

FINGERED

FINGERED provides you with a total of 15 different chord types. The following describes the FINGERED “accompaniment keyboard” and “melody keyboard”, and tells you how to play a C-root chord using FINGERED.

FINGERED Accompaniment Keyboard and Melody Keyboard

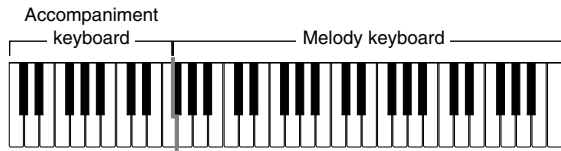

NOTE

- The accompaniment keyboard can be used for playing chords only. No sound will be produced if you try playing single melody notes on the accompaniment keyboard.

C 	Cm 	Cdim
Caug^{*1} 	Csus4 	C7^{*2}
Cm7^{*2} 	Cmaj7^{*2} 	Cm7^{b5}
C7^{b5}^{*1} 	C7sus4 	Cadd9^{*2}
Cmadd9^{*2} 	CmM7^{*2} 	Cdim7^{*1}

See the “Fingered Chord Chart” on page A-9 for details on playing chords with other roots.

- *1: Inverted fingerings cannot be used. The lowest note is the root.
- *2: The same chord can be played without pressing the 5th G.

NOTE

- Except for the chords specified in note^{*1}above, inverted fingerings (i.e. playing E-G-C or G-C-E instead of C-E-G) will produce the same chords as the standard fingering.
- Except for the exception specified in note^{*2}above, all of the keys that make up a chord must be pressed. Failure to press even a single key will not play the desired FINGERED chord.

FULL RANGE CHORD

This accompaniment method provides a total of 38 different chord types: the 15 chord types available with FINGERED plus 23 additional types. The keyboard interprets any input of three or more keys that matches a FULL RANGE CHORD pattern to be a chord. Any other input (that is not a FULL RANGE CHORD pattern) is interpreted as melody play. Because of this, there is no need for a separate accompaniment keyboard, so the entire keyboard, from end to end, functions as a melody keyboard that can be used for both melody and chords.

FULL RANGE CHORD Accompaniment Keyboard and Melody Keyboard

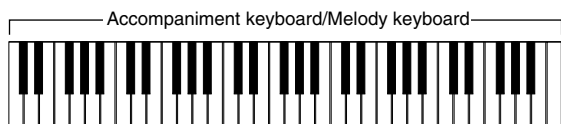

Chords Recognized by This Keyboard

The following table identifies patterns that are recognized as chords by FULL RANGE CHORD.

Pattern Type	Number of Variations
FINGERED	The 15 chord patterns shown under FINGERED on page E-30. See the "Fingered Chord Chart" on page A-9 for details on playing chords with other roots.
Standard Fingerings	23 standard chord fingerings. The following are examples of the 23 chords available with C as the bass note. $C_6 \bullet Cm_6 \bullet C_{69}$ $\frac{C^\#}{C} \bullet \frac{D}{C} \bullet \frac{E}{C} \bullet \frac{F}{C} \bullet \frac{G}{C} \bullet \frac{A^\flat}{C} \bullet \frac{B^\flat}{C}$ $\frac{B}{C} \bullet \frac{C^\#m}{C} \bullet \frac{Dm}{C} \bullet \frac{Fm}{C} \bullet \frac{Gm}{C} \bullet \frac{Am}{C} \bullet \frac{B^\flat m}{C}$ $\frac{Dm_7^\flat5}{C} \bullet \frac{A^\flat7}{C} \bullet \frac{F7}{C} \bullet \frac{Fm7}{C} \bullet \frac{Gm7}{C} \bullet \frac{A^\flat add9}{C}$

Example: To play the chord C major.

Any of the fingerings shown in the illustration below will produce C major.

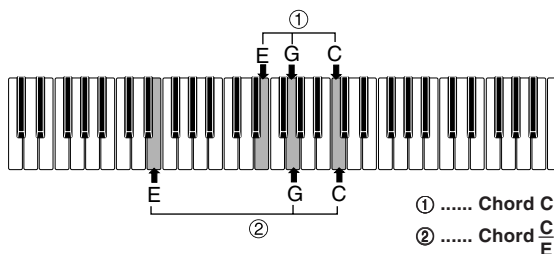

NOTE

- As with the FINGERED mode (page E-30), you can play the notes that form a chord in any combination (①).
- When the lowest note of a chord is separated from its neighboring note by six or more semitones, the lowest note becomes the bass note (②).

Using an Intro Pattern

This keyboard lets you insert a short intro into a rhythm pattern to make startup smoother and more natural.

The following procedure describes how to use the Intro feature. Before starting, you should first select the rhythm you want to use, and set the tempo.

To insert an intro

Press **INTRO/ENDING** button 1 or 2.

- With the above setup, the intro pattern is played and the auto accompaniment with intro pattern starts as soon as you play chords on the accompaniment keyboard.

NOTE

- The standard rhythm pattern starts to play after the intro pattern is complete.

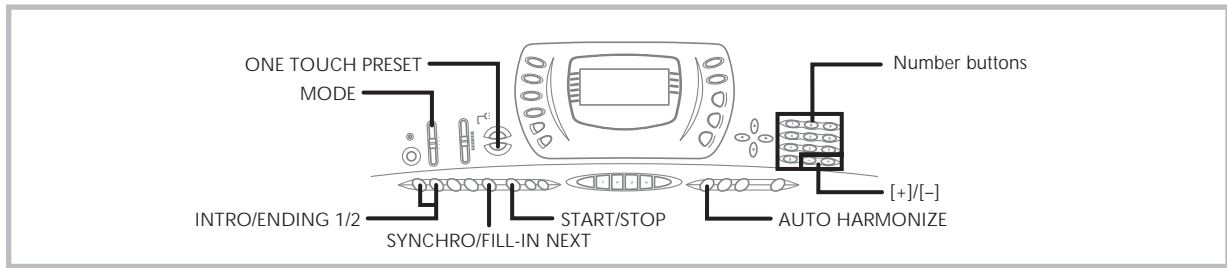

Using a Fill-in Pattern

Fill-in patterns let you momentarily change the rhythm pattern to add some interesting variation to your performances.

The following procedure describes how to use the Fill-in feature.

To insert a fill-in

1. Press the **START/STOP** button to start rhythm play.
2. Select the fill-in variation you want.
 - To select the Variation 1 rhythm, press the **VARIATION/FILL-IN 1** button.
 - To select the Variation 2 rhythm, press the **VARIATION/FILL-IN 2** button.

NOTE

- The fill-in pattern does not play if you press the **VARIATION/FILL-IN** button while an intro pattern is playing.

Using a Rhythm Variation

In addition to the standard rhythm pattern, you can also switch to a secondary “variation” rhythm pattern for a bit of variety.

To insert the variation rhythm pattern

1. Press the **START/STOP** button to start rhythm play.
2. Press the **SYNCHRO/FILL-IN NEXT** button.
 - If a Variation 1 rhythm is currently playing, this plays Fill-in 1, followed by Fill-in 2, and then switches to the Variation 2 rhythm.
 - If a Variation 2 rhythm is currently playing, this plays Fill-in 2, followed by Fill-in 1, and then switches to the Variation 1 rhythm.

Synchro Starting Accompaniment with Rhythm Play

You can set up the keyboard to start rhythm play at the same time you play the accompaniment on the keyboard.

The following procedure describes how to use synchro start. Before starting, you should first select the rhythm you want to use, set the tempo, and use the **MODE** switch to select the chord play method you want to use (**NORMAL**, **CASIO CHORD**, **FINGERED**, **FULL RANGE CHORD**).

To use synchro start

1. Press the **SYNCHRO/FILL-IN NEXT** button to put the keyboard into synchro start standby.



2. Play a chord and the rhythm pattern starts to play automatically.

NOTE

- If the **MODE** switch is set to **NORMAL**, only the rhythm plays (without a chord) when you play on the accompaniment keyboard.
- If you press the **INTRO/ENDING** button 1 or 2 before playing anything on the keyboard, the rhythm starts automatically with an intro pattern when you play something on the accompaniment keyboard.
- To cancel synchro start standby, press the **SYNCHRO/FILL-IN NEXT** button one more time.

Finishing with an Ending Pattern

You can end your performances with an ending pattern that brings the rhythm pattern you are using to a natural-sounding conclusion.

The following procedure describes how to insert an ending pattern. Note that the actual ending pattern played depends on the rhythm pattern you are using.

To finish with an ending pattern

While the rhythm is playing, press **INTRO/ENDING** button **1** or **2**.

- The timing when the ending pattern starts depends on when you press the **INTRO/ENDING** button **1** or **2**. If you press the button before the second beat of the current measure, the ending pattern starts playing immediately.

NOTE

- Pressing the button at any point in the measure after the second beat results in the ending pattern playing from the beginning of the following measure.

Using One-touch Preset

One-touch preset automatically makes the main settings listed below in accordance with the rhythm pattern you are using.

- Keyboard tone
- Layer on/off
- Tempo
- Effect type
- Harmonize on/off

To use one-touch preset

1. Select the rhythm you want to use.
2. Use the **MODE** switch to select the accompaniment mode you want to use.
3. Press the **ONE TOUCH PRESET** button.
 - This automatically makes the one-touch preset settings in accordance with the rhythm you selected.
 - The keyboard automatically enters synchro standby at this time.
4. Start rhythm and Auto Accompaniment, and play something on the keyboard.
 - Accompaniment is played using the one-touch preset settings.

Using Auto Harmonize

When you are using Auto Accompaniment, Auto Harmonize automatically adds three additional notes to your melody in accordance with the chord that is being played. The result is a harmony effect that makes your melody line richer and fuller.

To use Auto Harmonize

1. Use the **MODE** switch to select **FINGERED** or **CASIO CHORD** as the accompaniment mode.
2. Press **AUTO HARMONIZE** to turn on Auto Harmonize.
 - This causes an indicator to appear next to **AUTO HARMONIZE** on the display.

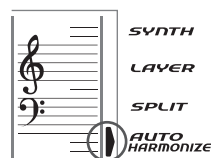

3. Start Auto Accompaniment play, and play something on the keyboard.
4. To turn off Auto Harmonize, press **AUTO HARMONIZE** once.
 - This causes the indicator next to **AUTO HARMONIZE** to disappear.

NOTE

- Auto Harmonize turns off temporarily whenever you start demo tune play. It turns back on as soon as the operation or function that caused it to turn off is finished.
- Auto Harmonize is enabled only when the Auto Accompaniment mode is **FINGERED** or **CASIO CHORD**.

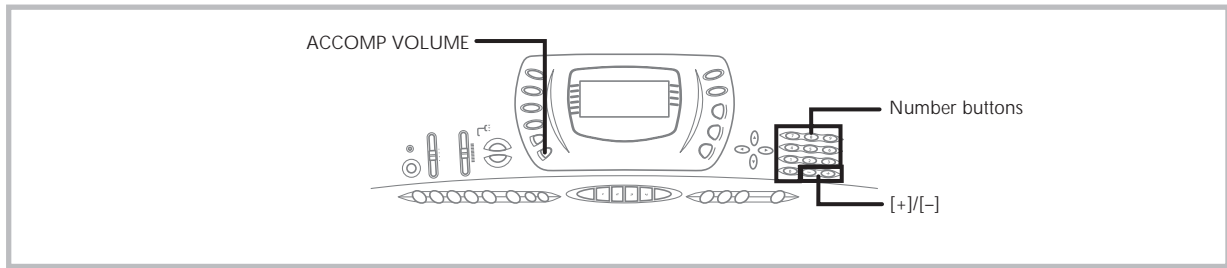

About Auto Harmonize notes and tones

The notes you play on the keyboard are called “melody notes,” while the notes added to the melody by Auto Harmonize is called the “harmonize notes.” Auto Harmonize normally uses the tone you selected for the melody notes as the tone for the harmonize notes, but you can use the Mixer (page E-35) to specify a different tone for the harmonize notes. The harmonize note tone is assigned to Mixer Channel 5, so change Channel 5 to the tone you want to use for the harmonize notes.

In addition to the tone, you can also use the Mixer to change a number of other parameters, such as volume balance. See “Using the Parameter Edit Mode” on page E-36 for details on these procedures.

NOTE

- The default harmonize note tone when you first turn on Auto Harmonize is the same tone as the melody note tone.
- Changing the melody tone setting automatically changes the harmonize note tone to the same setting.

Adjusting the Accompaniment Volume

You can adjust the volume of the accompaniment parts as a value in the range of 000 (minimum) to 127 (maximum).

1. Press the **ACCOMP VOLUME** button.

Current accompaniment volume setting

100 Ac omp Vol

2. Use the number buttons or the [+]/[-] buttons to change the current volume setting value.

Example: 110

110 Ac omp Vol

NOTE

- Pressing the **ACCOMP VOLUME** button or **[▲]** (EXIT) button returns to the tone or rhythm setting screen.
- Any channel balance settings you make with the Mixer are maintained when you change the accompaniment volume setting.
- Pressing **[+]** and **[-]** buttons at the same time automatically sets an accompaniment volume of 100.



Mixer Function

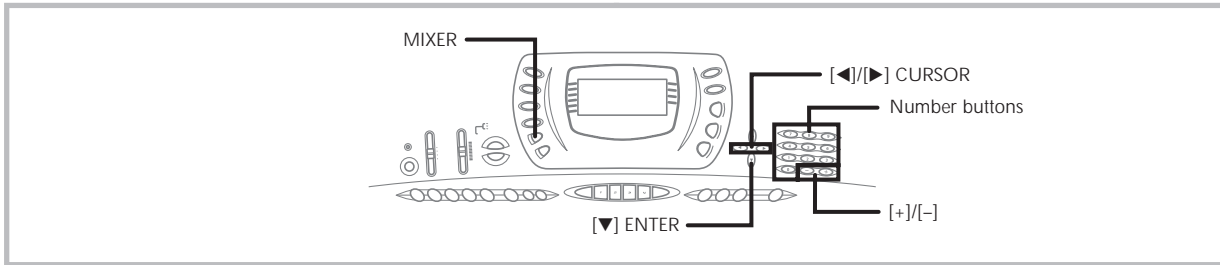

What you can do with the Mixer

This keyboard lets you play multiple different musical instrument parts at the same time during auto-accompaniment play, song memory playback, receipt of data through the MIDI terminal, etc. The Mixer assigns each part to a separate channel (1 through 16) and lets you control the channel on/off, volume, and pan pot parameters of each channel.

Channel Assignments

The following shows the parts that are assigned to each of the 16 channels.

Channel Number	Part
Channel 1	Main tone
Channel 2	Layered tone
Channel 3	Split tone
Channel 4	Layered/split tone
Channel 5	Harmonize Tone
Channel 6	Auto Accompaniment chord part 1
Channel 7	Auto Accompaniment chord part 2
Channel 8	Auto Accompaniment chord part 3
Channel 9	Auto Accompaniment bass part
Channel 10	Auto Accompaniment rhythm part
Channel 11	Memory track 1
Channel 12	Memory track 2
Channel 13	Memory track 3
Channel 14	Memory track 4
Channel 15	Memory track 5
Channel 16	Memory track 6

See page E-59 and E-60 for information on layered, split, and layered/split tones.

See page E-46 for information on the song memory.

NOTE

- Normally, keyboard play is assigned to Channel 1. When Auto Accompaniment is being used, each part of the accompaniment is assigned to Channels 6 through 10.
- When this keyboard is being used as the sound source for an externally connected computer or other MIDI device, all 16 channels are assigned musical instrument parts. The notes played over the channel selected by steps 1 and 2 under "Turning Channels On and Off" in the right column of this page are shown on the displayed keyboard and staff.

Turning Channels On and Off

Turning a channel off mutes any instrument recorded in the channel.

To turn channels on and off

1. Press the **MIXER** button.
 - This causes the MIXER indicator to appear on the display screen.
 - This displays the channel selection screen.

2. Use the **[+]/[-]** buttons to select a channel.
Example: To select Channel 2.

3. Press **[▼] (ENTER)** and then **[▶] (CURSOR)** to display the on/off selection screen.

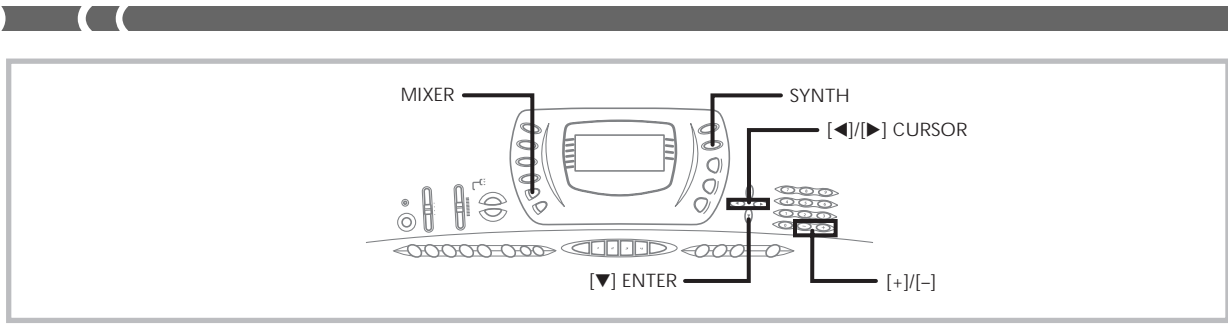

4. Use the [+] / [-] buttons to select on or off.
Example: To turn the channel off.



- Press [▲] (EXIT) to return to the channel selection screen.
- Pressing the MIXER button returns to the Tone Screen.

NOTE

- The MIDI data display shows only the data for the channels selected with the Mixer.

How Channel On/Off Works

The following describes what happens and what appears on the display when you turn a channel on or off.

On (on)

This setting turns on the currently selected channel, which is indicated by a bar appearing at the bottom of the level meter for that channel. This is also the default setting for all channels when the keyboard is turned on.

Off (oFF)

This setting turns off the currently selected channel, which is indicated by the absence of the bar at the bottom of the level meter for that channel.

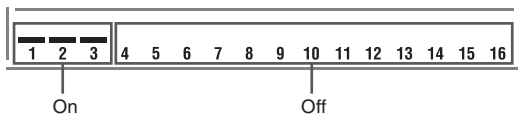

Using the Parameter Edit Mode

In the Parameter Edit Mode, you can change the settings of ten different parameters (including tone, volume, and pan pot) for the channel you selected on the Mixer screen.

To change parameters

1. Use the channel selection screen to select a channel.
2. Use [▼] (ENTER) to enter the Parameter Edit Mode.
3. Use [◀] and [▶] (CURSOR) to select the parameter whose setting you want to change.

Example: Select volume setting by displaying "Volume".

- Each press of [◀] or [▶] (CURSOR) cycles through the parameters.

Indicates channel volume of 127



4. Use the number buttons or [+] and [-] to change the parameter setting.

Example: Change the setting to "060".



- Pressing the MIXER button exits the parameter edit mode.
- Pressing [▲] (EXIT) returns to the channel selection screen.

How Parameters Work

The following are the parameters whose settings can be changed in the Parameter Edit Mode.

Tone Parameters

■ Tone (Range: 000 to 247)

This parameter controls the tones assigned to each part.

000 Tone No.

■ NOTE

- The displayed tone number has only two digits when an Advanced tone is selected.

■ Part On/Off (Settings: on, oFF)

This parameter can be used to turn each part on (sounds) and off (does not sound). The current on/off status of each part is indicated on the display as described below.

■ Volume (Range: 000 to 127)

This is the parameter that controls the volume of the selected channel.

127 Volume

■ Pan Pot (Range: -64 to 00 to +63)

This parameter controls the pan pot, which is the center point of the left and right stereo channels. Setting "00" specifies center, a value less than "00" moves the point left, and a value greater than "00" moves it right.

63 Pan

■ Octave Shift (Range: -2 to 0 to +2)

You can use octave shift to shift the range of the tone up or down. When using the piccolo tone, there may be cases when very high notes you want to play are not included within the range of the keyboard. When this happens, you can use octave shift to shift the keyboard range one octave up.

0 Oct Shift

- 2 : Range shifted two octaves down.
- 1 : Range shifted one octave down.
- 0 : No shift
- +1 : Range shifted one octave up.
- +2 : Range shifted two octaves up.

Tuning Parameters

You can use these parameters to tune each of the parts individually.

■ Coarse Tune (Range: -24 to 00 to +24)

This parameter controls the coarse tuning of the selected channel's pitch in semitone units.

00C Tune

■ Fine Tune (Range: -99 to 00 to +99)

This parameter controls the fine tuning of the selected channel's pitch in cent units.

00 Fine Tune

Effect Parameters

The Mixer lets you control the effects applied to each individual part, making it different from the Effect Mode, whose settings are applied to all parts in general.

■ Reverb Send (Range: 000 to 127)

This parameter controls how much reverb is applied to a part. A setting of "000" turns reverb off, while a setting of 127 applies maximum reverb.

056 Rvb Send

■ Chorus Send (Range: 000 to 127)

This parameter controls how much chorus send is applied to a part. A setting "000" turns chorus send off, while a setting of 127 applies maximum chorus send.

- "Chorus Send" does not work with drum sounds.

000 Cho Send

■ DSP Line (Settings: on, oFF)

You can use this parameter to turn DSP line off for a particular channel, or to turn it on.

oFF DSP Line

■ NOTE

- Changing the tone, volume, pan pot, coarse tune, fine tune, reverb send, or chorus send setting causes the corresponding MIDI message to be output from the MIDI terminal.
- Changing the tone settings changes the tone, reverb send, chorus send, and DSP line* parameter settings.

* When DSP is off (See the note on page E-26.)



Synthesizer Mode

The Synthesizer Mode of this keyboard provides the tools for creating your own original tones. Simply select one of the built-in tones and change its parameters to create your own original sound. You can even store your sounds in memory and select it using the same procedure as that used to select a preset tone.

Synthesizer Mode Functions

The following describes how to use each of the functions available in the Synthesizer Mode.

Synthesizer Mode Parameters

The preset tones that are built into this keyboard consist of a number of parameters. To create a user tone, you first recall a General MIDI tone (100 to 227) or a preset tone (000 to 099) and then change its parameters to change it to your own tone. Note that drum set tones (228 through 237) cannot be used as the basis of a user tone.

The illustration below shows the parameters that make up the preset tones and what each parameter does. As can be seen in the illustration, these parameters can be divided into four groups, each of which is described in detail below.

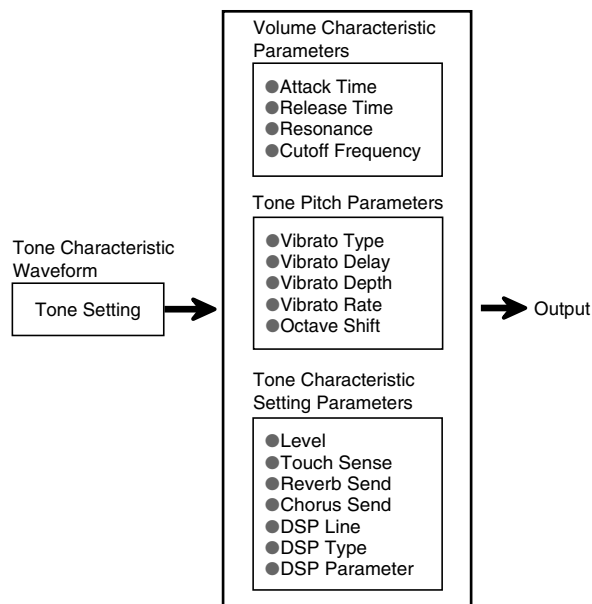

NOTE

- Synthesizer Mode operations affect the tone selected for Channel 1.

(1) Tone Characteristic Waveform

■ Tone Setting

Specifies which of the preset tones should be used as the original tone.

(2) Volume Characteristic Parameters

These parameters control how the tone changes over time, from when the keyboard key is pressed until the tone decays. You can specify changes in volume and sound characteristics.

■ Attack time

This is the rate or time it takes for the tone to reach its highest volume level. You can specify a fast rate, where the tone reaches its highest volume level immediately, a slow rate where it gradually rises, or something in between.

■ Release time

This is the rate or time it takes for the tone volume to fall to zero. You can specify a release that ranges from a sudden fall to zero, to one that gradually falls to zero.

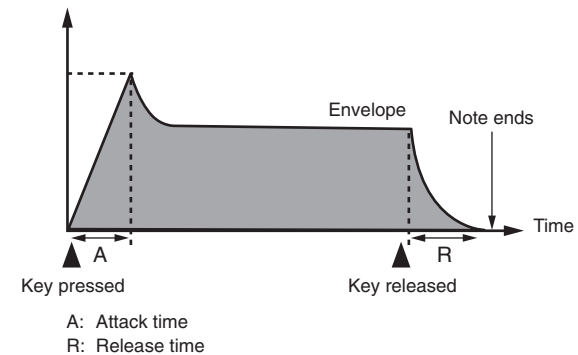

■ Cutoff Frequency

The cutoff frequency is a parameter for adjusting timbre by cutting any frequency that is higher than a specific frequency. A larger cutoff frequency produces a brighter (harder) timbre, while a smaller frequency produces a darker (softer) timbre.

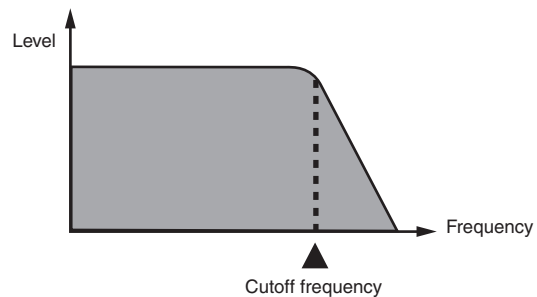

■ Resonance

Resonance enhances the harmonic components in the vicinity of the cutoff frequency, which creates a distinctive sound. A larger resonance value enhances the sound as shown in the figure.

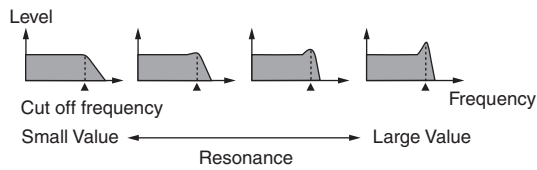

■ NOTE

- With some tones, a large resonance value can cause distortion or noise during the attack part of the tone.

(3) Tone Pitch Parameters

■ Vibrato Type, Vibrato Delay, Vibrato Depth, Vibrato Rate

These parameters adjust the vibrato effect, which causes periodic changes in the tone.

■ Octave Shift

This parameter controls the octave of all tones.

(4) Tone Characteristic Setting Parameters

■ Level

This parameter controls the overall volume of the tone.

■ Touch Sense

This parameter controls changes in volume and timbre in accordance with the relative amount of pressure applied to the keyboard keys. You can specify more volume for stronger pressure and less volume for a lighter pressure, or you can specify the same volume regardless of how much pressure is applied to the keys.

■ Reverb Send, Chorus Send, DSP Line, DSP Type, DSP Parameter

These parameters control the effects applied to tones.

Saving User Tones

The group of tone numbers from 238 through 247 (User 01 through User 10) is called the “user area” because they are reserved for storage of user tones. After you recall a preset tone and change its parameters to create your own user tone, you can store it in the user area for later recall. You can recall your tones using the same procedure that you use when selecting a preset tone.

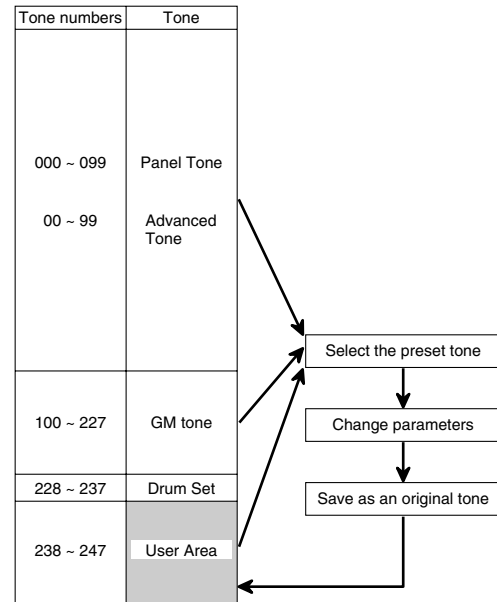

■ NOTE

- The keyboard is shipped from the factory with tone number 000 (piano) assigned to the user area.
- Note that creating a user tone (000 to 227) does not change the preset tone. It creates a new version of the preset tone for storage in the user area.
- You cannot use a drum set tone (228 to 237) as the basis of a user tone.

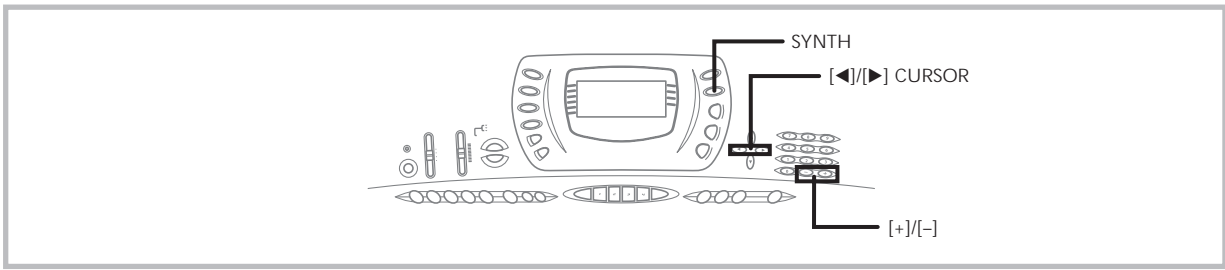

Creating a User Tone

Use the following procedure to select a preset tone and change its parameters to create a user tone.

1. First, select the preset tone you want to use as a basis for your user tone.
2. Press the **SYNTH** button.
 - This enters the Synth Mode, which is indicated by the indicator next to SYNTH on the display screen.

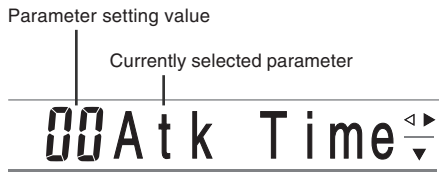

3. Use [**◀**] and [**▶**] (**CURSOR**) to display the parameter whose setting you want to change.



- Each press of [**◀**] or [**▶**] (**CURSOR**) changes to the next parameter. See "Parameters and Their Settings" on this page for information on setting range for each parameter.
4. Use [**+**] and [**-**] to change the setting of the currently selected parameter.
 - You can also use the number buttons to input a value to change a parameter setting. See "Parameters and Their Settings" on this page for information on setting range for each parameter.
 5. After you are finished editing the sound, press the **SYNTH** button to exit the Synthesizer Mode.

NOTE

- See "Storing a User Tone In Memory" on page E-42 for details on saving user tone data to memory so it is not deleted.

Parameters and Their Settings

The following describes the function of each parameter and provides its set range.

■ Attack Time (Range: -64 to 00 to +63)

Time it takes before the tone sounds after a key is pressed

-01 Atk Time

■ Release Time (Range: -64 to 00 to +63)

Time the tone continues to sound after a key is released

-07 Rel. Time

■ Vibrato Type (Vibrato Waveform) (Range: See below.)

Specifies the vibrato type (waveform).

5 in Vib. Type

Value	Meaning	Waveform
Sin	Sine Wave	
tri	Triangle Wave	
SAU	Sawtooth Wave	
Sqr	Square Wave	

■ Vibrato Delay (Range: -64 to 00 to +63)

Specifies the amount of time before vibrato starts.

00 Vib Delay

■ **Vib.Depth (Vibrato Depth) (Range: -64 to 00 to +63)**

Depth of the vibrato effect

12 VibDepth

■ **Vib.Rate (Vibrato Rate) (Range: -64 to 00 to +63)**

Rate (speed) of the vibrato effect

02 Vib.Rate

■ **Cut Off Freq. (Cutoff frequency)
(Range: -64 to 00 to +63)**

High-band cutoff for the harmonic components of the tone

-06 C-off Freq

■ **Resonance (Range: -64 to 00 to +63)**

Resonance of the tone

-08 Resonan

■ **Oct.Shift (Octave Shift) (Range: -2 to 0 to +2)**

Up/down octave shift

-1 OctShift

■ **Level (Range: 000 to 127)**

This parameter controls the overall volume of the tone. The greater the value, the greater the volume. Setting a level of zero means that the tone does not sound at all. This parameter can be set in a range of 000 to 127.

096 Level

■ **Touch Sensitivity (Range: -64 to 00 to +63)**

This parameter controls changes in the volume of the tone in accordance with the pressure applied to the keyboard keys. A greater positive value increases the volume of the output as pressure increases, while a negative value decreases volume with increased keyboard pressure. A setting of zero specifies no change in output volume in accordance with keyboard pressure. This parameter can be set in a range of -64 to +63.

32 TchSense

■ **Reverb Send (Range: 000 to 127)**

This parameter adjusts reverb.

127 Rvb Send

■ **Chorus Send (Range: 000 to 127)**

This parameter adjusts chorus.

112 Cho Send

■ **DSP Line (Settings: on, oFF)**

This parameter controls whether or not the DSP effect is used.

on DSP Line

■ **DSP Type (Range: 000 to 109)**

This parameter specifies a type when a DSP effect is being used.

065 Ovrdrive

■ **DSP Parameter**

This setting specifies DSP parameters. See "DSP Parameters" on page E-25, "Effect List" on page A-10, and "DSP Algorithm List" on page A-12 for more information.

■ **NOTE**

- If you store an original tone with the DSP line turned on (see next page), simply recalling the tone automatically changes the DSP line, DSP type, and DSP parameter settings. This simplifies the recall of original tones that include a DSP effect.
- An indicator appears next to DSP on the display while you are making DSP type or DSP parameter settings.

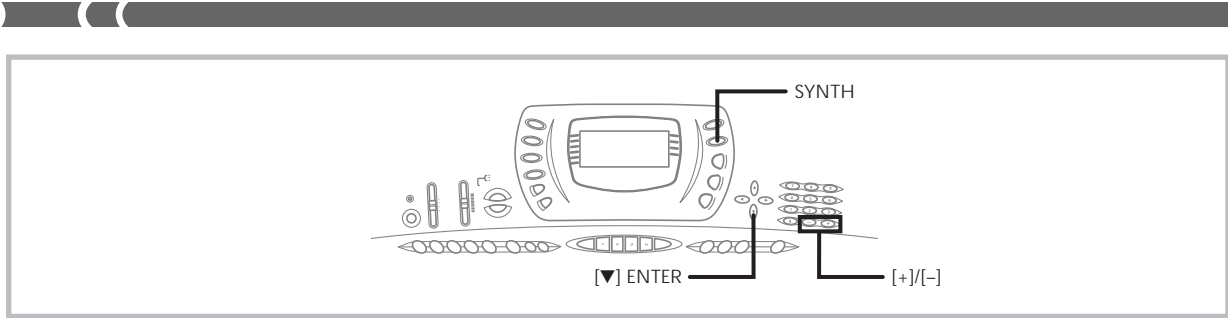

User Tone Creation Hints

The following hints provide helpful advice on making user tone creation a bit quicker and easier.

Use a preset tone that is similar to the one you are trying to create.

Whenever you already have a rough idea of the tone you are trying to create, it is always a good idea to start with a preset tone that is similar.

■ Experiment with various different settings.

There are no real rules about what a tone should sound like. Let your imagination run free and experiment with different combinations. You may be surprised at what you can achieve.

Storing a User Tone In Memory

The following procedure shows how to store a user tone in memory. Once a tone is stored, you can call it up just as you do with a preset tone.

To name a user tone and store it in memory

1. Select a preset tone to use as the basis for the user tone, press the **SYNTH** button to enter the Synthesizer Mode, and make the parameter settings you want.
2. After making parameter settings to create the user tone, press **[▼] (ENTER)**.
3. Use **[+]** and **[-]** to change the user area tone number on the display until the one where you want to store the tone is shown.
 - You can select any tone number from 238 to 247.



4. Press **[▼] (ENTER)** to save the user tone.
 - The message "Save OK" appears momentarily on the display, followed by the tone or rhythm selection screen.
 - To abort the save operation at any time, press the **SYNTH** button or the **[▲] (EXIT)** button to exit the Synthesizer Mode. Pressing the **SYNTH** button again (before selecting another tone) returns to the Synthesizer Mode with all of your parameter settings still in place.

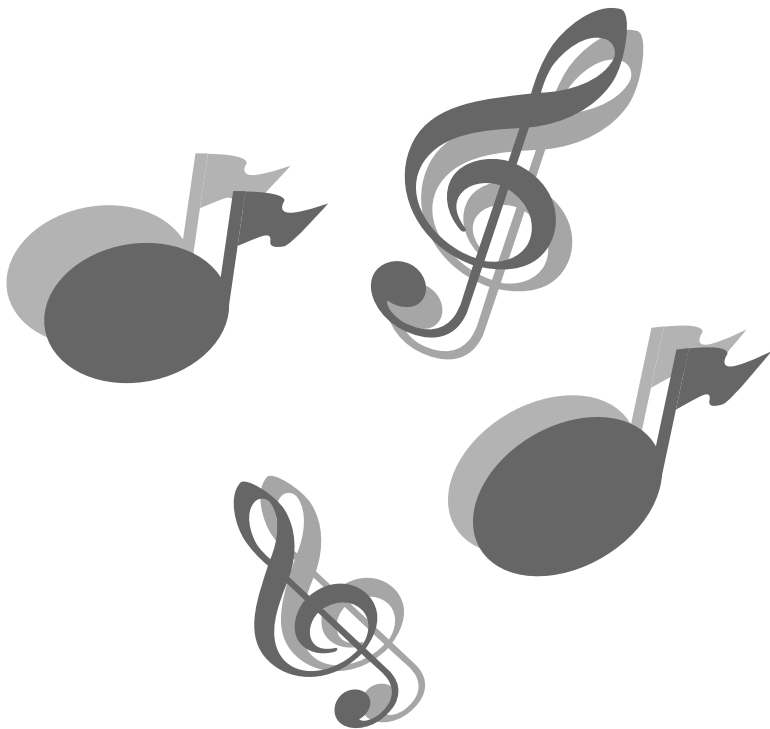
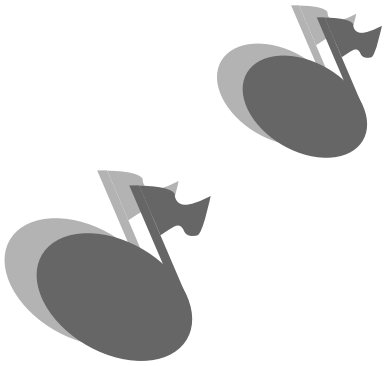



Registration Memory

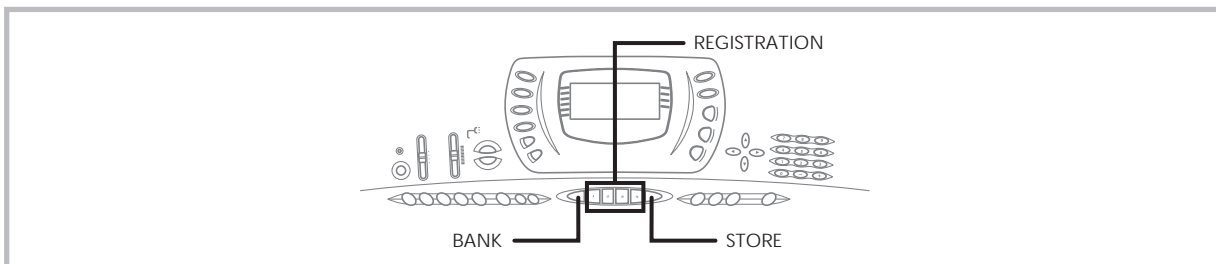

Registration Memory Features

Registration memory lets you store up to 16 keyboard setups (4 sets x 4 banks) for instant recall whenever you need them. The following is a list of settings that are saved in registration memory.

Registration Memory Settings

- Tone
- Rhythm
- Tempo
- Split on/off
- Split point
- Layer on/off
- Mixer settings (Channels 1 to 10)
- Effect settings
- Equalizer settings
- Touch Response settings
- Assignable jack setting
- Transpose
- Tuning
- Accompaniment volume setting
- Harmonize on/off

NOTE

- Registration memory functions are disabled while you are using the Synthesizer, Song Memory or demo tune function.
- In addition to preset tones, user tones created by altering synthesizer parameters and stored in user memory are also saved to registration memory.

Initial Settings

BANK 0

Area	TONE	RHYTHM
1	* OVD ROCK ORGAN + TENOR SAX	8 BEAT DANCE
2	* VELO.ALTO SAX + GRAND PIANO	16 BEAT 2
3	* TREMOLO E.PIANO + MODERN E.PIANO	16 BEAT BALLAD 3
4	GRAND PIANO	8 BEAT 1

BANK 1

Area	TONE	RHYTHM
1	* VELO.ALTO SAX + ROCK ORGAN	POP
2	* E.PIANO PAD + WHISTLE	POP BALLAD
3	* MORE DISTORTION GT	ROCK 2
4	ELEC.GUITAR	BLUES

BANK 2

Area	TONE	RHYTHM
1	* OVD ROCK ORGAN + ALTO SAX	DANCE 1
2	* VELO.ALTO SAX + ELEC.PIANO	DISCO SOUL
3	* VELO.CLARINET + TENOR SAX	MID BIG BAND
4	* VELO.ALTO SAX + TRUMPET	JAZZ COMBO

BANK 3

Area	TONE	RHYTHM
1	* VELO.TRUMPET + ACCORDION	POLKA
2	* VELO.FLUTE + NYLON STR.GUITAR	BOSSA NOVA 1
3	* VELO.TENOR SAX + STEEL DRUMS	REGGAE 1
4	* STEREO STRINGS + GLOCKENSPIEL	BROADWAY

* : Advanced tone

Setup Names

You can assign setups into one of 16 areas, which you can select using BANK buttons 1 through 4 and the four REGISTRATION buttons. Area names range from 0-1 through 3-4 as shown below.

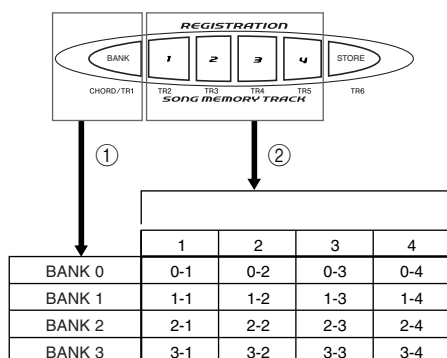

- ① Use the BANK button to select the bank. Each press of BANK cycle through the bank numbers from 0 to 3.
- ② Pressing one of the REGISTRATION buttons (1 to 4) selects the corresponding area in the currently selected bank.

NOTE

- Whenever you save a setup and assign it a setup name, any setup data previously assigned to that name is replaced with the new data.
- You can use the keyboard's MIDI capabilities to save your setup data to a computer or other external storage device. See "Using the Data Download Service" on page E-68 for details.

To Save a Setup in Registration Memory

1. Select a tone and rhythm, and otherwise set up the keyboard the way you want it.
 - See "Registration Memory Settings" on page E-44 for details on what data is stored in the registration memory.
2. Use the BANK button to select the bank you want.
 - If you do not perform any operation for about five seconds after pressing the BANK button, the display returns to the contents in step 1, above.
 - Bank 1 selected.

1--Bank

3. While holding down the STORE button, press a REGISTRATION button (1 to 4).

- The following display appears when you press the 2 button.

1-2Store

4. Release the STORE and REGISTRATION buttons.

NOTE

- The setup is saved as soon as you press a REGISTRATION button in step 3, above.

To Recall a Setup from Registration Memory

1. Use the BANK button to select the bank.
 - If you do not perform any operation for about five seconds after pressing the BANK button, the keyboard automatically clears the registration memory recall screen.

1--Bank

2. Press the REGISTRATION button (1 to 4) for the area whose setup you want to recall.

1-2Recall

- The setup name along with the message "Recall" appears on the display.

NOTE

- If you press a REGISTRATION button without using the BANK button to select a bank first, the last bank number selected is used.



Song Memory Function

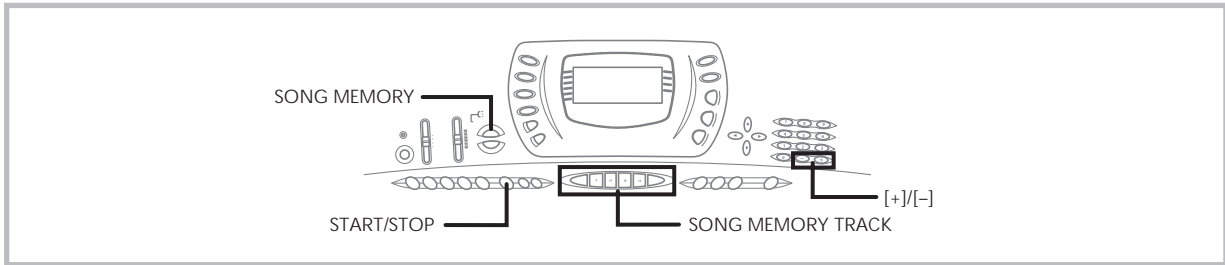

This keyboard lets you record up to two separate songs in song memory for later playback. There are two methods you can use to record a song: real-time recording where you record the notes as you play them on the keyboard, and step recording where you input chords and notes one-by-one.

NOTE

- Layer and split cannot be used while standing by for recording or while recording is being performed in the Song Memory Mode. Also, layer and split are automatically turned off whenever the keyboard goes into record standby or starts recording.

Tracks

Keyboard song memory records and plays back much like a standard tape recorder. There are a total of six tracks, each of which can be recorded separately. Besides notes, each track can have its own tone number. Then when you play back the tracks together, it sounds like an entire six-piece band. During playback, you can adjust the tempo to change the speed of playback.

	Start	End
Track 1	Auto accompaniment (Rhythm, Bass, Chord 1/2/3), Keyboard play	→
Track 2	Keyboard play	→
Track 3	Keyboard play	→
Track 4	Keyboard play	→
Track 5	Keyboard play	→
Track 6	Keyboard play	→

Melody data recorded in track.

NOTE

- With this keyboard, Track 1 is the basic track, which can be used to record keyboard play, along with Auto Accompaniment. Tracks 2 through 6 can be used for keyboard play, so they are called melody tracks. Tracks 2 through 6 are used to add other parts to what is recorded in Track 1.
- Note that each track is independent of the others. This means that even if you make a mistake while recording, you only need to re-record the track where the mistake was made.
- You can use different Mixer settings for each track (page E-35).

Selecting a Track

Use the SONG MEMORY TRACK buttons marked CHORD/TR1 through TR6 to select the track you want.

Song Memory Track Buttons

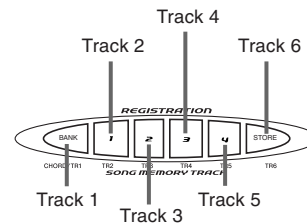

Basic Song Memory operations

The status of the Song Memory changes each time you press the SONG MEMORY button.

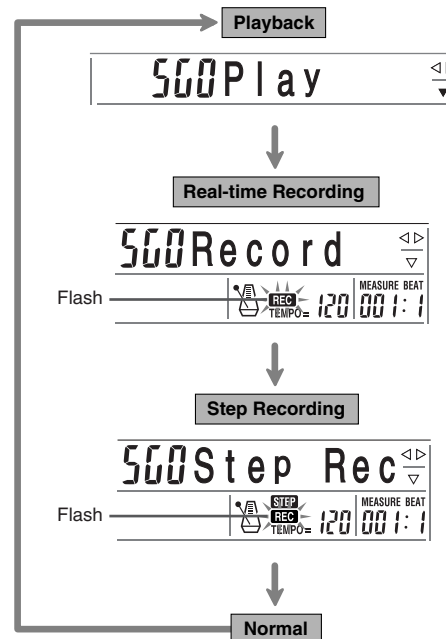

Using Real-time Recording

With real-time recording, the notes you play on the keyboard are recorded as you play them.

To record with real-time recording

1. Press the **SONG MEMORY** button twice to enter real-time record standby.
 - Perform step 2, below, within five seconds after entering record standby.
2. Use the **[+]** and **[-]** buttons to select a song number.

Song number (0 or 1)



- The above song number screen remains on the display for about five seconds. If it disappears before you have a chance to select a song number, use the **SONG MEMORY** button again to re-display it.
3. Press the **CHORD/TR1** button, which is one of the **SONG MEMORY TRACK** buttons, to select Track 1.



- The level meters for tracks 11 through 16 are shown on the display while the keyboard is in record standby, so you can easily check which tracks are already recorded. See "Level Meter Contents During Record/Edit Standby" on page E-53 for details.
4. Make the following settings.
 - Tone number
 - Rhythm number
 - Tempo
 - MODE switch
 5. Press the **START/STOP** button to start recording.
 - When recording starts, the **REC** indicator flashes on the display. After a few moments the indicator stops flashing, and remains on the display.
 6. Play something on the keyboard.
 - You can also record Auto Accompaniment chords by selecting the applicable mode with the **MODE** switch.
 - Optional pedal operation is also recorded. See "Track 1 Contents After Real-time Recording".

7. Press the **START/STOP** button to end recording when you are finish playing.

- If you make a mistake while recording, you can stop the record operation and begin over again from step 1, or you can use the editing function (page E-55) to make corrections.

NOTE

- Using real-time recording to record to a track that already contains recorded data replaces the previous recording with the new one.

Track 1 Contents After Real-time Recording

In addition to keyboard notes and accompaniment chords, the following data is also recorded to Track 1 during real-time recording. This data is applied whenever Track 1 is played back.

- Tone number
- Rhythm number
- **INTRO/ENDING 1** button, **INTRO/ENDING 2** button, **VARIATION/FILL-IN 1** button, **VARIATION/FILL-IN 2** button, **SYNCRHO/FILL-IN NEXT** button operations
- Pedal operations (option)
- Effect type
- Accompaniment volume

NOTE

- Starting a record operation also records the Mixer settings for the other tracks to the song header.

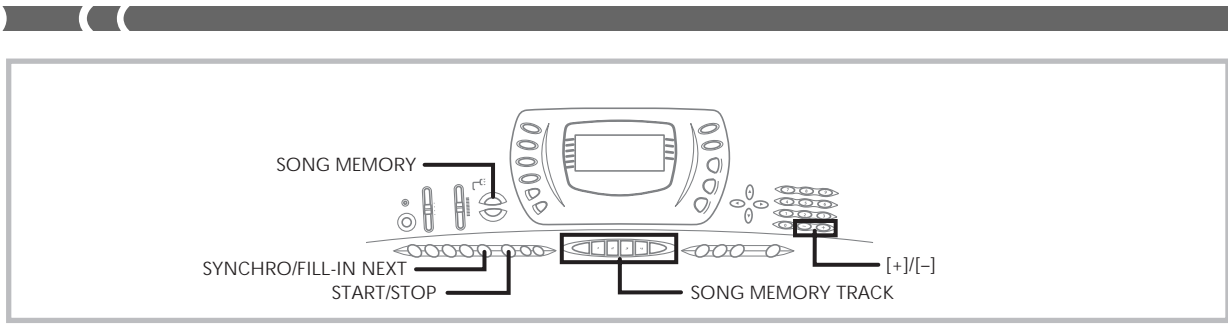

Mixer Mode Settings

Channel 1 Mixer parameters (page E-36) are automatically recorded to Track 1. You can use the Mixer to change each of the parameters.

Memory Capacity

The keyboard has memory for approximately 3,500 notes. You can use all 3,500 notes for a single song, or you can divide memory between two different songs.

- The measure number and note number flash on the display whenever remaining memory is less than 100 notes.
- Recording automatically stops (and auto-accompaniment and rhythm stops playing if they are being used) whenever memory becomes full.
- The same memory area is used for song memory and user rhythm memory. Because of this, the number of notes you can store in song memory is lower when there is user rhythm data stored in memory. You can clear memory contents and free up more space for song memory space using the Initialize / Delete setting menu (page E-65).

Memory Data Storage

- Whenever you make a new recording, anything previously stored in memory is replaced.
- Memory contents are retained as long as the keyboard is being supplied with electrical power. Unplugging the AC adaptor when batteries are not loaded or when loaded batteries are dead cuts off the keyboard's electrical power supply, clearing all data stored in memory. Plug the keyboard into a wall outlet with the AC adaptor before replacing batteries.
- Turning off the keyboard while a record operation is in progress causes the contents of the track you are currently recording to be lost.
- Remember that you can dump memory contents to another MIDI device using the procedure described under "Using the Data Download Service" on page E-68.

Track 1 Real-time Recording Variations

The following describes a number of different variations you can use when recording to Track 1 using real-time recording. All of these variations are based upon the procedure described under "To record with real-time recording" on page E-47.

● To record without rhythm

Skip step 5. Real-time recording without a rhythm starts when you press a keyboard key.

● To start recording with synchro start

In place of step 5, press the SYNCHRO/FILL-IN NEXT button. Auto-accompaniment and recording will both start when you play a chord on the accompaniment keyboard.

● To record using an intro, ending, or fill-in

During recording, the INTRO/ENDING 1/2, SYNCHRO/FILL-IN NEXT, and VARIATION/FILL-IN 1/2 buttons (pages E-31 to 32) can all be used as they normally are.

● To synchro start Auto Accompaniment with an intro pattern

In place of step 5, press the SYNCHRO/FILL-IN NEXT button and then INTRO/ENDING 1 or INTRO/ENDING 2 button. Auto-accompaniment will start with the intro pattern when you play a chord on the accompaniment keyboard.

● To start Auto Accompaniment part way into a recording

In place of step 5, press the SYNCHRO/FILL-IN NEXT button and then play something on the melody keyboard to start recording without Auto Accompaniment. When you reach the point where you want accompaniment to start, play a chord on the accompaniment keyboard to start Auto Accompaniment.

Playing Back from Song Memory

Once you record tracks to song memory, you can play them back to see what they sound like.

To play back from song memory

1. Use the **SONG MEMORY** button to enter playback standby, and then use the **[+]** and **[-]** buttons to select a song number (0/1).

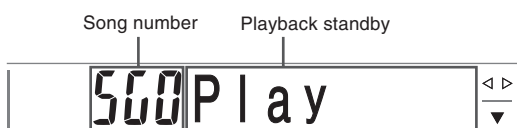

- The above song number screen remains on the display for about five seconds. If it disappears before you have a chance to select a song number, use the **SONG MEMORY** button again to re-display it.
2. Press the **START/STOP** button to playback the song you selected.
 - You can use the **TEMPO** buttons to adjust the playback tempo.
 - Press the **START/STOP** button again to stop playback.

NOTE

- You can play along on the keyboard using layer (page E-57) and split (page E-57) during playback.
- Pressing the **START/STOP** button to start playback from song memory always starts from the beginning of the song.
- The entire keyboard functions as a melody keyboard, regardless of the **MODE** switch setting.

To turn off a specific track

Press the **SONG MEMORY TRACK** button of the track you want to turn off, or use the **Mixer** (Page E-35) to turn off the channel of the track.

Recording Melody and Chords with Step Recording

With step recording, you can record Auto-Accompaniment chords and notes, and even specify note lengths one by one. Even those who find it difficult to play along on the keyboard with an Auto-Accompaniment can create Auto-Accompaniments based on their own original chord progressions. The following shows the type of data that can be recorded in Tracks 1 through 6.

Track 1: Chords and Auto-Accompaniment
Tracks 2 through 6: Keyboard play

With step recording, first record the chords and Auto-Accompaniment in Track 1. Next, record the melody in Tracks 2 through 6.

NOTE

- Use the procedure under “To record to Tracks 2 through 6 using step recording” on page E-52 for details on how to record to Tracks 2 through 6.
- You can use Track 1 for the melody if you do not plan to record chords or Auto-Accompaniment. Select Track 1 and then perform the procedure under “To record to Tracks 2 through 6 using realtime recording” on page E-52 to record. In this case, set the **MODE** switch to **NORMAL** before you start recording.

To record chords with step recording

1. Press the **SONG MEMORY** button three times to enter step recording standby, and then use the **[+]** and **[-]** buttons to select either 0 or 1 as the song number.

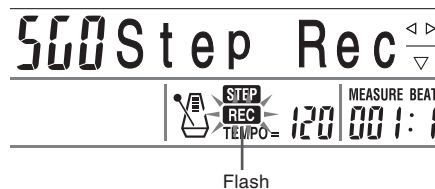

2. Make the following settings.
 - Rhythm number
 - **MODE** switch
3. Press the **CHORD/TR1** button, which is one of the **SONG MEMORY TRACK** buttons, to select Track1.
 - When recording starts, the **REC** indicator flashes on the display. After a few moments the indicator stops flashing, and remains on the display.
4. Press the **SYNCHRO/FILL-IN NEXT** button.

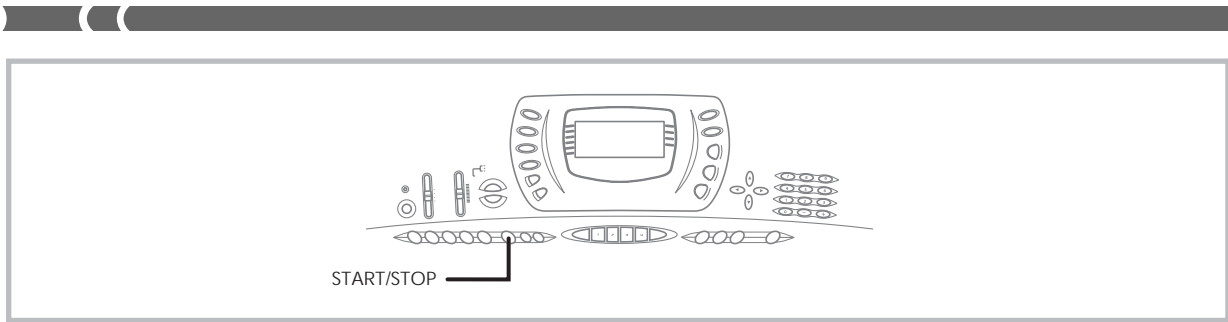

5. Play a chord.

- Use the chord play method that is specified by the current MODE switch setting (FINGERED, CASIO CHORD, etc.).
- When the MODE switch is set to NORMAL, specify the chord using the root input keyboard and chord type input keyboard. See “Specifying Chords in the Normal Mode” on this page for details.

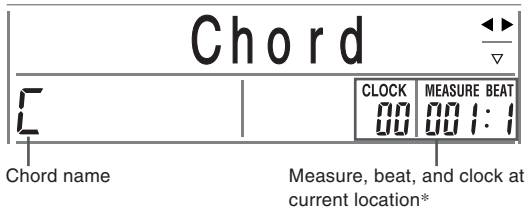

Chord name Measure, beat, and clock at current location*

* 96 clocks = 1 beat

6. Input the length of the chord (how long it should be played until the next chord is played).

- Use the number buttons to specify the length of the chord. See “Specifying the Length of a Note” on page E-51 for details.
- The specified chord and its length are stored in memory and the keyboard stands by for input of the next chord.
- Repeat steps 5 and 6 to input more chords.

7. After you are finished recording, press the START/STOP button.

- This enters playback standby for the song you have just recorded.
- To play back the song at this time, press the START/STOP button.

NOTE

- Use the procedure under “Correcting Mistakes While Step Recording” on page E-54 to correct input mistakes you make during step recording.
- You can add on to a track that already contains recorded data by selecting that track in step 3 of the above procedure. Doing so automatically locates the step recording start point at the first beat immediately following the previously recorded data.
- Inputting “0” as the chord length in steps 5 and 6 of the above procedure specifies a rest, but the rest is not reflected in the accompaniment contents when the accompaniment is played.

Track 1 Contents After Step Recording

In addition to chords, the following data is also recorded to Track 1 during step recording. This data is applied whenever Track 1 is played back.

- Rhythm number
- INTRO/ENDING 1 button, INTRO/ENDING 2 button, VARIATION/FILL-IN 1 button, VARIATION/FILL-IN 2 button, SYNCRHO/FILL-IN NEXT button operations

Specifying Chords in the Normal Mode

When the MODE switch is set to NORMAL during step recording, you can specify chords using a method that is different from CASIO CHORD and FINGERED fingerings. This chord specification method can be used to input 18 different chord types using only two keyboard keys, so chords can be specified even if you don’t know how to actually play them.

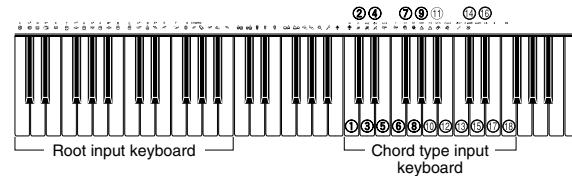

- | | |
|-----------------------|---------------------------|
| ① Major | ⑩ Seventh flat five |
| ② Minor | ⑪ Minor seventh flat five |
| ③ Augmented | ⑫ Seventh suspended four |
| ④ Diminished | ⑬ Diminished seventh |
| ⑤ Suspended four | ⑭ Minor add ninth |
| ⑥ Seventh | ⑮ Add ninth |
| ⑦ Minor seventh | ⑯ Minor sixth |
| ⑧ Major seventh | ⑰ Sixth |
| ⑨ Minor major seventh | ⑱ Six ninth |

To specify a chord, hold down the key on the root input keyboard that specifies the root, and press the key in the chord type input keyboard to specify the chord type. When inputting a chord with a specified bass note, pressing two keys of the root input keyboard causes the lower note to be specified as a bass note.

Example 1: To input Gm7, hold down G on the root input keyboard and press the m7 key on the chord type input keyboard.

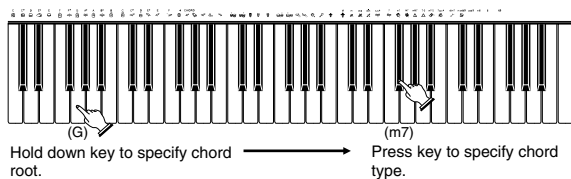

Example 2: To input Gm/C, hold down C and G on the root input keyboard and press the m key on the chord type input keyboard.

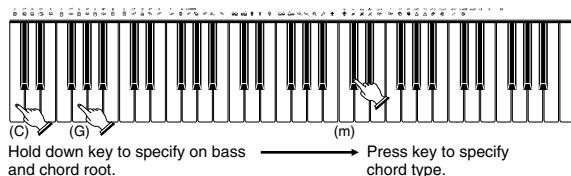

Specifying the Length of a Note

During step recording, the number buttons are used to specify the length of each note.

● Note lengths

Use number buttons [1] through [6] to specify whole notes (♩), half notes (♪), quarter notes (♫), eighth notes (♮), 16th notes (♯), and 32nd notes (♭).

Example: To specify a quarter note (♫), press [3].

● Dots (.) and triplicates (≡)

While holding down the [7] (dot) or [9] (triplicate), use buttons [1] through [6] to input the lengths of the notes.

Example: To input a dotted eighth notes (♮), hold down [7] and press [4].

● Ties

Input the first and then the second note.

Example: To input ♪ ♪, press [4] and then [8]. Next, press [5]. This note will be tied to the next note input (16th note in this example).

● Rest

Hold down [0] and then use number buttons [1] through [9] to specify the length of the rest.

Example: To input an eighth note rest, hold down [0] and press [4].

Track 1 Step Recording Variations

The following describes a number of different variations you can use when recording to Track 1 using step recording. All of these variations are based upon the procedure described under "To record chords with step recording" on page E-49.

● To start accompaniment with an intro pattern

In step 4, press INTRO/ENDING 1 or INTRO/ENDING 2 button after the SYNCHRO/FILL-IN NEXT button.

● To switch to a rhythm variation

In step 5, press VARIATION/FILL-IN 1 or VARIATION/FILL-IN 2 button immediately before inputting the chord.

● To insert a fill in

In step 5, press VARIATION/FILL-IN 1 or VARIATION/FILL-IN 2 button at the measure or beat immediately before the chord or beat where you want to insert the fill in.

● To insert an ending

In step 5, press INTRO/ENDING 1 or INTRO/ENDING 2 button at the measure or beat immediately before the chord where you want to insert the ending.

IMPORTANT!

The length of the ending depends on the rhythm you are using. Check the length of the pattern you are using and set the length of the chord accordingly in step 6. Making the chord too short in step 6 can result in the ending pattern being cut off.

● To step record chords without rhythm

Skip step 4. The specified chord of the length specified by the number buttons is recorded. A rest can be specified here, so an original chord pattern can be created.

● To add chord accompaniment part way through rhythm play

In Place of step 4 at the start of the recording, press VARIATION/FILL-IN 1 or VARIATION/FILL-IN 2 button and input rests. Then in step 5, input the chords. Only rhythm is played where you input the rests, and then chord play starts after the rests.

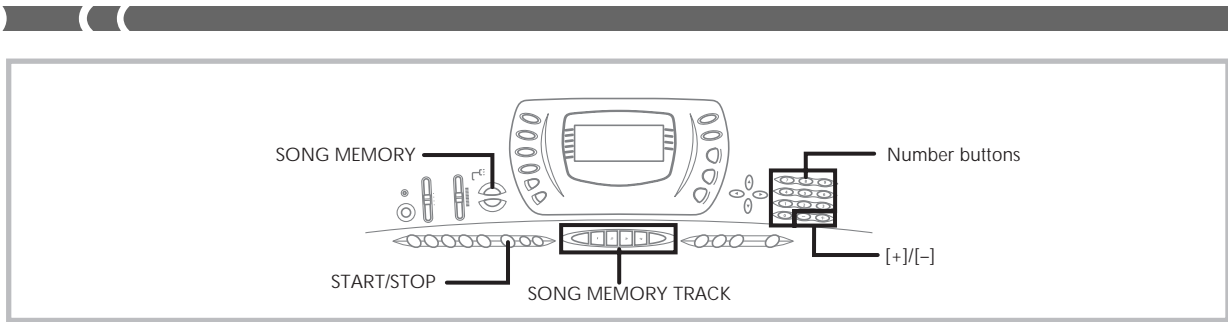

Recording Multiple Tracks

Track 1 of the keyboard's song memory records Auto Accompaniment and keyboard play. In addition, there are five other melody tracks that you can use to record melody parts only. You can record different tones to the melody tracks and build a full ensemble of instruments for your recordings. The procedure you use for recording to Tracks 2 through 6 is identical to the one you use when recording to Track 1.

To record to Tracks 2 through 6 using real-time recording

You can record to Tracks 2 through 6 while playing back what you originally recorded on Track 1 and any other tracks that are already recorded.

1. Press the **SONG MEMORY** button twice to enter record standby, and then use the **[+]** and **[-]** buttons to select a song number (0/1).
 - The song number you select should be the one where you previously input Track 1.
2. Use the **SONG MEMORY TRACK** buttons to select the track you want to record to (2 through 6).
 - While the keyboard is in record standby, the display shows the level meters for channels 11 through 16, so you can check which tracks have already been recorded. See "Level Meter Contents During Record/Edit Standby" on page E-53 for details.
3. Make the following settings.
 - Tone number
 - Tempo (to set playback of the recorded tracks to a tempo that is easy for you to follow)
4. Press the **START/STOP** button to start recording.
 - At this time, the contents of any tracks that are already recorded start to play back.
 - Optional pedal operation you perform is also recorded.

5. Use the keyboard to play what you want to record the track you selected.
6. Press the **START/STOP** button to end recording when you are finished.

Track Contents After Real-time Recording

In addition to keyboard notes, the following data is also recorded to the selected track during real-time recording. This data is applied whenever the track is played back.

- Tone number
- Optional pedal operations

NOTE

- Starting a record operation also records the Mixer settings for the other tracks to the song header.

To record to Tracks 2 through 6 using step recording

This procedure describes how to input notes one-by-one, specifying each note's pitch and length.

1. Press the **SONG MEMORY** button three times to enter real-time record standby, and then use the **[+]** and **[-]** buttons to select a song number (0/1).
 - The song number you select should be the one where you previously input Track 1.

50 | Step Rec

- Use the **SONG MEMORY TRACK** buttons to select the track you want to record to (2 through 6).

Example: Select Track 2.



- Specify a tone number.
 - After changing the tone number, press any keyboard key to clear the tone number and name screen, and return to the note input screen.
- Use the keyboard keys to input notes, or the [0] button to input rests.
 - When touch response is turned on, the amount of pressure you use to press the keyboard keys is also recorded. You can also use keyboard keys to input chords.
- Use the number buttons to input the length of the note or rest (page E-51).
- Repeat steps 4 and 5 to input more notes.
- Press the **START/STOP** button to end recording when you are finished.

NOTE

- Use the procedure under "Correcting Mistakes While Step Recording" on page E-54 to correct input mistakes you make during step recording.
- You can add on to a track that already contains recorded data by selecting that track in step 2 of the above procedure. Doing so automatically locates the step recording start point at the first beat immediately following the previously recorded data.
- Whenever you are recording to Tracks 2 through 6, the entire keyboard functions as a melody keyboard, regardless of the current MODE switch setting.

Track Contents After Step Recording

In addition to notes and rests, the following data is also recorded to the track during step recording. This data is applied whenever the track is played back.

- Tone number

Level Meter Contents During Record/Edit Standby

Channels 11 through 16 correspond to Tracks 1 through 6. Whenever the keyboard is in record or edit (page E-55) standby, the level meter display shows which tracks already contain recorded data and which are still empty. Tracks with four lit segments already contained recorded data, while tracks with one lit segment are not yet recorded.

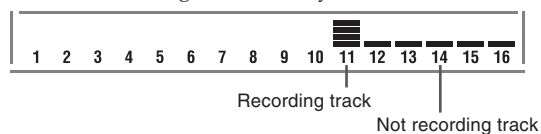

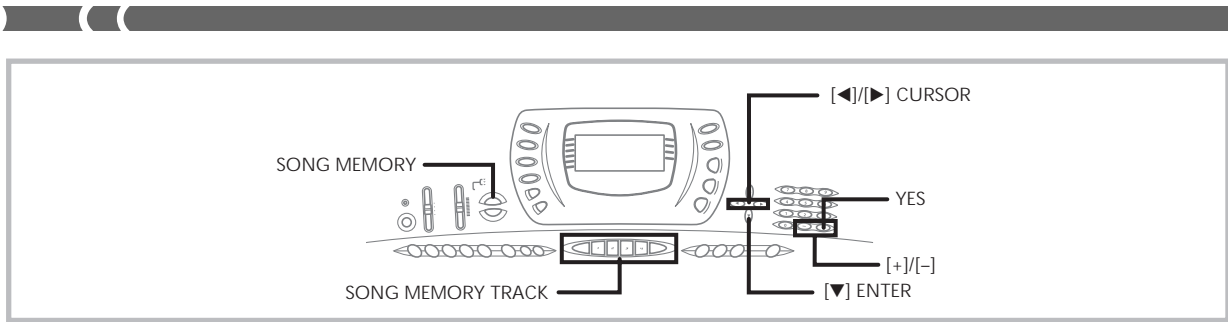

Correcting Mistakes While Step Recording

Memory data can be thought of as a musical score that progresses from left to right, with the input point normally at the far right of the recorded data.

The procedure described here lets you move the input point to the left in order to make changes in data you have already input. Note, however, that moving the input point to the left and changing data automatically deletes all of the data recorded to the right of the input point.

To correct mistakes while step recording

- Without exiting step recording, use the [◀] (CURSOR) button to move the input point to the left.
 - The REC indicator disappears from the display, and the STEP indicator flashes.

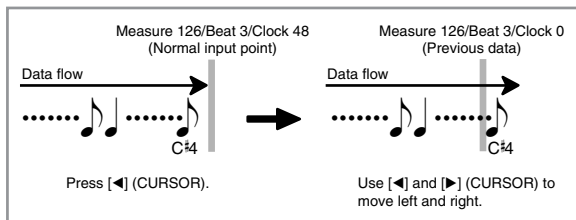
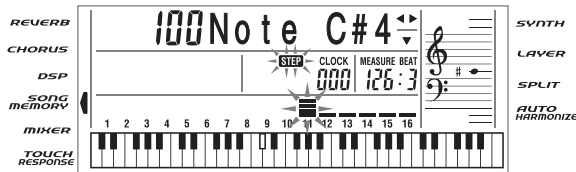

- Monitoring the data on the display, use [◀] and [▶] (CURSOR) to move the input point to the data you want to change.

Example: To re-record all note data following the note A3 located at Measure 120, Beat 1, Clock 0.

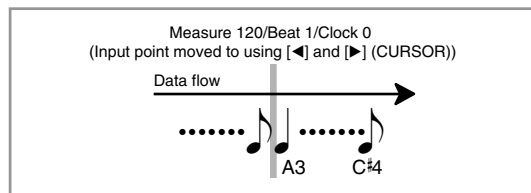
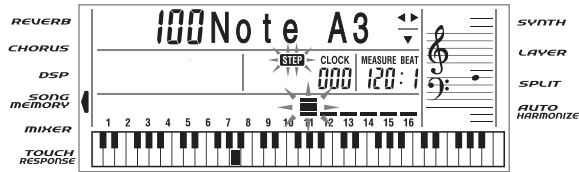

- Press the [▼] (ENTER) button, and then press the [▶] (CURSOR) button.

Rewrite?

- Press the YES button.
 - This deletes all data from the location you specified and enters step record standby.
 - Pressing the [▲] (EXIT) button or the NO button cancels deleting the data.

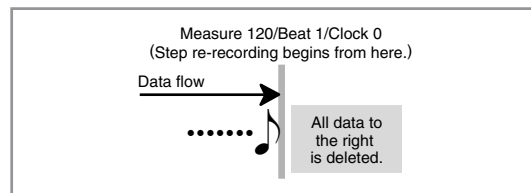

NOTE

- If you move the input position to the end of the data with the [▶] (CURSOR) button, the REC indicator appears on the display, and the STEP indicator stops flashing and remains on the display.

To delete specific note data

1. Perform steps 1 and 2 under “To correct mistakes while step recording” above to display the note you want to delete.
2. Press the [▼] (ENTER) button.
3. In response to the “Delete?” message that appears on the screen, press the YES button to delete the displayed note.

Editing Memory Contents

After you record to keyboard memory, you can recall individual notes and parameter settings (such as tone number) and make any changes you want. This means you can correct misplayed notes, make changes in tone selections, etc.

The following types of data can be edited.

- Note intensity
- Notes
- Chords
- Tone numbers
- Rhythm number
- INTRO/ENDING 1 button, INTRO/ENDING 2 button, VARIATION/FILL-IN 1 button, VARIATION/FILL-IN 2 button, SYNCRHO/FILL-IN NEXT button operations

To edit memory contents

1. Press the **SONG MEMORY** button three times to enter step recording standby, and then use the [+] and [-] buttons to select either 0 or 1 as the song number.

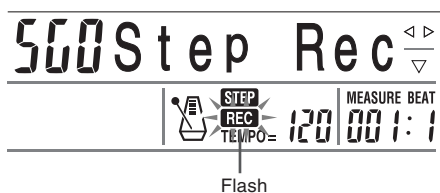

2. Use the **SONG MEMORY TRACK** buttons to select the recorded track that you want to edit.
3. Press the [◀] (CURSOR) button to enter the editing mode.
 - The REC indicator disappears from the display, and the STEP indicator flashes.

4. Use the [◀] and [▶] (CURSOR) buttons to move to the location in track where the note or parameter you want to change is located.

Note editing example

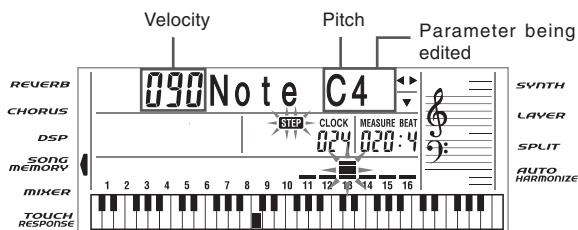

5. Make any changes in the value that you want.
 - The actual procedures you use to change a parameter depend on the type of data it contains. See “Editing Techniques and Display Contents” on page E-56 for details.
6. Repeat steps 4 and 5 to edit other parameters.
7. Press the **START/STOP** button to end editing when you are finished.

NOTE

- The only parameters that can be edited for Tracks 2 through 6 are notes and tone numbers.
- In the case of real-time recording, you later can change tone numbers you specified while recording to Tracks 1 through 6 is in progress.
- You can only change tone numbers that were originally set for Tracks 2 through 6 using step recording.
- In the case of real-time recording, you later can change rhythm numbers you specified while recording to Track 1 is in progress.
- You can only change rhythm numbers that were originally set for Track 1 using step recording.
- You cannot use the edit procedure to add more data to a recording.
- You cannot move portions of a recording to a different location within the recording.
- Note lengths cannot be changed.

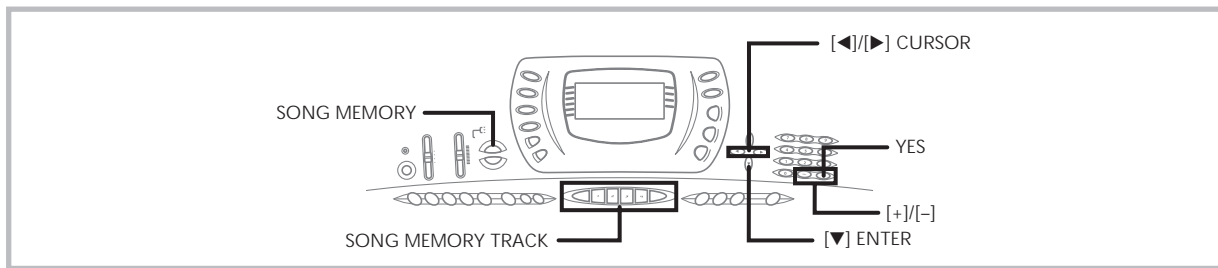

Editing Techniques and Display Contents

The following describes the editing techniques you can use to change the various parameters stored in memory.

● To change the key pressure (velocity) of a note

Use the number buttons or [+] and [-] to adjust the key pressure.



● To change the pitch of a note

Input a new note on the keyboard or use [+] and [-] buttons to change the pitch of a note. The pitch you specify here is reflected in the keyboard and the notes shown in the staff on the display.



IMPORTANT!

Whenever editing memory contents, never change a note so it is identical to the note before or after it. Doing so may alter the length of the changed note and the note before or after it. Should this happen, you will have to re-record the entire track.

● To change a chord

Use the chord fingering method selected by the MODE switch (FINGERED, CASIO CHORD, etc.) to input a chord.

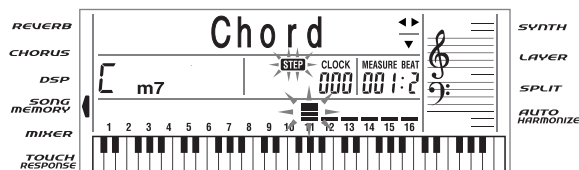

● To change a tone number

Use the number buttons or [+] and [-] buttons to change a tone number.



NOTE

- In the case of real-time recording, you later can change tone numbers you specified while recording to Tracks 1 through 6 is in progress.
- You can only change tone numbers that were originally set for Tracks 2 through 6 using step recording.

● To change a rhythm number

Use the number buttons or [+] and [-] buttons to change a rhythm number.



NOTE

- In the case of real-time recording, you later can change rhythm numbers you specified while recording to Track 1 is in progress.
- You can only change rhythm numbers that were originally set for Track 1 using step recording.

● To change a rhythm controller operation *

* INTRO/ENDING 1 button, INTRO/ENDING 2 button, VARIATION/FILL IN 1 button, VARIATION/FILL IN 2 button, SYNCRHO/FILL IN NEXT button operations
Press the rhythm controller button you want to change to.



Editing a Song

You can perform the following operations in the song editing mode.

- Delete a song
- Delete a track
- Song header data rewrite (Panel Record)

To delete a song

1. Press the **SONG MEMORY** button once to enter playback standby.
2. Use the **[+]** and **[-]** buttons to select the number of the song you want to delete.
3. Press the **[▼] (ENTER)** button.
 - This displays the song delete screen.
4. Press the **YES** button.
 - This causes the message "Sure?" to appear, confirming whether you really want to delete the song.
5. Press the **YES** button to delete the song and return to playback standby.

To delete a specific track

1. Press the **SONG MEMORY** button once to enter playback standby.
2. Use the **[+]** and **[-]** buttons to select the number of the song that contains the track you want to delete.
3. Press the **[▼] (ENTER)** button.
 - This displays the song delete screen.

4. Press the **[◀]** or **[▶]** (**CURSOR**) button to display the track delete screen.

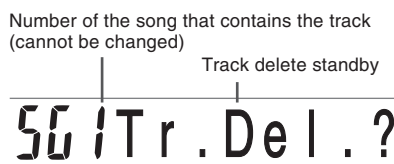

5. Use the **SONG MEMORY TRACK** buttons to select the recorded track or tracks whose data you want to delete.

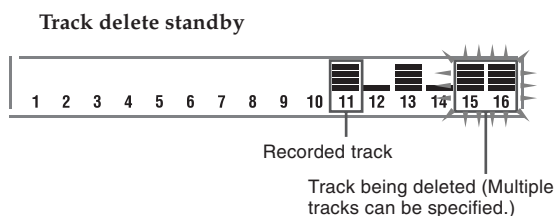

- You can specify more than one track for deletion by pressing more than one track select button.
- To deselect a track, simply press its track select button again.

6. Press the **YES** button.
 - This causes the message "Sure?" to appear, confirming whether you really want to delete the track.
7. Press the **YES** button to delete the track.

NOTE

- You cannot change the song number while in track delete standby.
- In the above procedure, you cannot select any track that does not contain any recorded data.
- Pressing the **SONG MEMORY** button while in track delete standby returns to record standby.

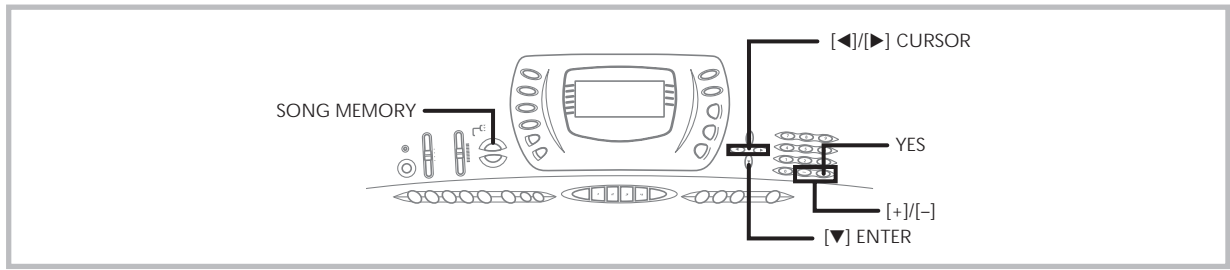

To rewrite song header data (Panel Record)

You can use a procedure called "Panel Record" to change the initial Mixer, tempo and other settings stored in the song header.

1. Press the **SONG MEMORY** button once to enter playback standby.
2. Use the **[+]** and **[-]** buttons to select the number of the song that contains the header data you want to rewrite.
3. Make the changes you want to the header data.
4. Press the **[▼] (ENTER)** button.
 - This displays the song delete screen.
5. Press the **[◀]** or **[▶]** (**CURSOR**) button to display the panel record screen.
 - This causes the message "Pnel Rec?" to appear on the display.
6. Press the **YES** button to rewrite the header data.

Keyboard Settings

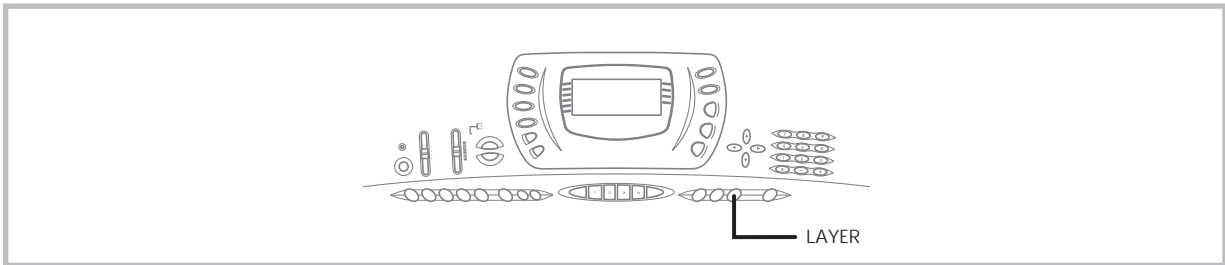

This section describes how to use layer (to play two tones with a single key) and split (to assign different tones to either end of the keyboard), and how to make touch response, transpose, and tuning settings.

Using Layer

Layer lets you assign two different tones (a main tone and a layered tone) to the keyboard, both of which play whenever you press a key. For example, you could layer the FRENCH HORN tone on the BRASS SECTION tone to produce a rich and brassy sound.

LAYER

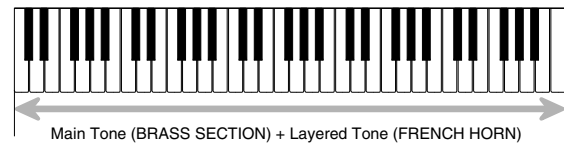

To layer tones

1. First select the main tone.
Example: To select “065 BRASS SECTION” as the main tone, press the TONE button and then use the number buttons to input 0, 6 and then 5.



2. Press the LAYER button.

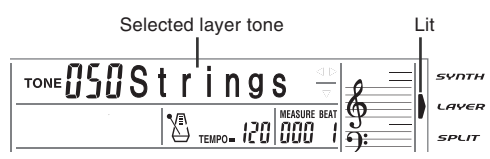

3. Select the layered tone.

Example: To select “064 FRENCH HORN” as the layered tone, use the number buttons to input 0, 6 and then 4.



4. Now try playing something on the keyboard.
 - Both tones are played at the same time.
5. Press the LAYER button again to unlayer the tones and return the keyboard to normal.

NOTE

- The main tone sounds over Channel 1, while the layered tone sounds over Channel 2. You can also use the Mixer to change the tone and volume settings for these channels.
- Layer cannot be used while standing by for recording or while recording is being performed in the Song Memory Mode.

Using Split

With split you can assign two different tones (a main tone and a split tone) to either end of the keyboard, which lets you play one tone with your left hand and another tone with your right hand. For example, you could select STRINGS as the main (high range) tone and PIZZICATO STRINGS as the split (low range) tone, putting an entire string ensemble at your fingertips.

Split also lets you specify the split point, which is the location on the keyboard where the changeover between the two tones occurs.

NOTE

- Leave the MODE switch in the NORMAL or FULL RANGE CHORD position.

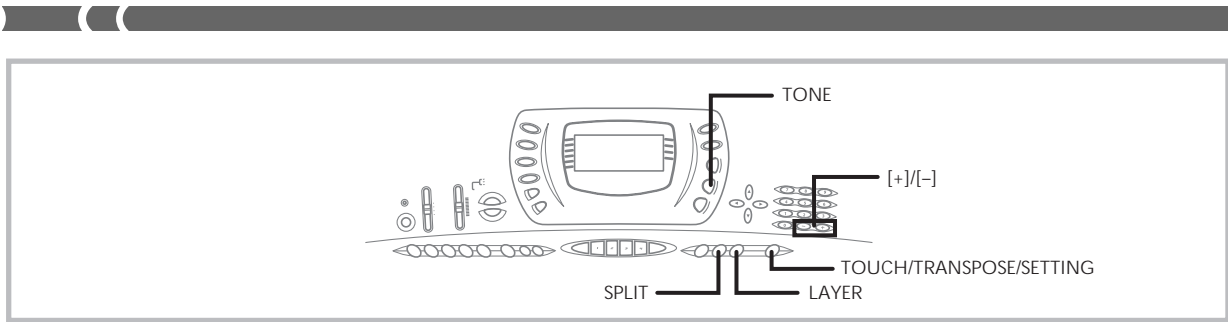

SPLIT

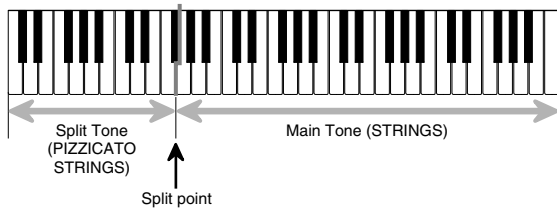

To split the keyboard

1. First select the main tone.

Example: To select “050 STRINGS” as the main tone, press the TONE button and then use the number buttons to input 0, 5 and then 0.



2. Press the SPLIT button.

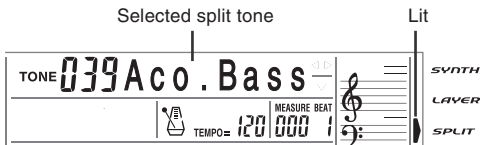

3. Select the split tone.

Example: To select “048 PIZZICATO STRINGS” as the split tone, use the number buttons to input 0, 4 and then 8.



4. Specify the split point. While holding down the SPLIT button, press the keyboard key where you want the leftmost key of the high end range to be.

Example: To specify G3 as the split point, press the G3 key.



5. Now try playing something on the keyboard.

- Every key from F#3 and below is assigned the PIZZICATO STRINGS tone, while every key from G3 and above is assigned the STRINGS tone.

6. Press the SPLIT button again to unsplit the keyboard and return it to normal.

NOTE

- The main tone sounds over Channel 1, while the split tone sounds over Channel 3. You can also use the Mixer to change the tone and volume settings for these channels.
- Split cannot be used while standing by for recording or while recording is being performed in the Memory Mode.
- When the MODE switch is set to CASIO CHORD or FINGERED, the accompaniment keyboard range is in accordance with the split point you specify with the above procedure.

Using Layer and Split Together

You can use layer and split together to create a layered split keyboard. It makes no difference whether you layer tones first and then split the keyboard, or split the keyboard and then layer tones. When you use layer and split in combination, the high range of the keyboard is assigned two tones (main tone + layered tone), and the low range two tones (split tone + layered split tone).

LAYER SPLIT

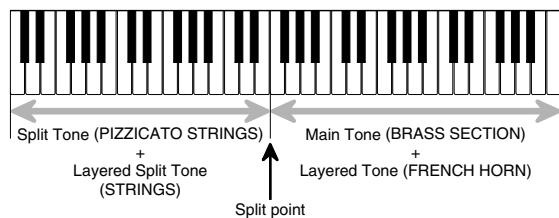

To split the keyboard and then layer tones

1. Press the **TONE** button and then input the tone number of the main tone.

Example: To set “065 BRASS SECTION” as the main tone.

TONE 065 Brs Sect

2. Press the **SPLIT** button and then input the number of the split tone.

Example: To set “048 PIZZICATO STRINGS” as the split tone.

TONE 048 Pizz. Str

- After specifying the split tone, press the **SPLIT** button to unsplit the keyboard.

3. Press the **LAYER** button and then input the number of the layered tone.

Example: To set “064 FRENCH HORN” as the layered tone.

TONE 064 Fr. Horn

4. Press the **SPLIT** button or the **LAYER** button so both of the **SPLIT** and **LAYER** indicators are displayed.

5. Input the number of the layered split tone.

Example: To specify the “050 STRINGS” tone, enter 0, 5, 0.

TONE 050 Strings

6. While holding down the **SPLIT** button, press the keyboard key where you want the lowest note (the leftmost key) of the upper range (right side range) to be.

7. Play something on the keyboard.

- Press the **LAYER** button to unlayer the keyboard, and the **SPLIT** button to unsplit it.

NOTE

- The main tone sounds over Channel 1, the layer tone over Channel 2, the split tone over Channel 3, and the layer/split tone over Channel 4. You can also use the Mixer to change the tone and volume settings for these channels.

Using Touch Response

When touch response is turned on, the relative volume of sound output by the keyboard is varied in accordance with the amount of pressure applied, just like an acoustic piano.

To turn touch response on and off

1. Press the **TOUCH/TRANSCOPE/SETTING** button.

- This displays the Touch Response setting screen.

2 Touch

2. Use the **[+]** and **[-]** buttons to select the touch response sensitivity level.

oFF Touch : 1 Light : 2 Normal : 3 Heavy

- “1 Light” outputs powerful sound even with light key pressure, while “3 Heavy” requires very heavy key pressure to output powerful sound.
- Pressing **[+]** and **[-]** at the same time returns sensitivity to the “2 Normal” setting.
- When you select “oFF Touch”, the tone does not change regardless of how much pressure you apply to the keyboard. This causes the **TOUCH RESPONSE** indicator to disappear from the display.

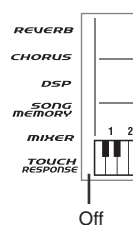

NOTE

- Touch response not only affects the keyboard’s internal sound source, it also is output as MIDI data.
- Song Memory playback, accompaniment, and external MIDI note data does not affect the touch response setting.

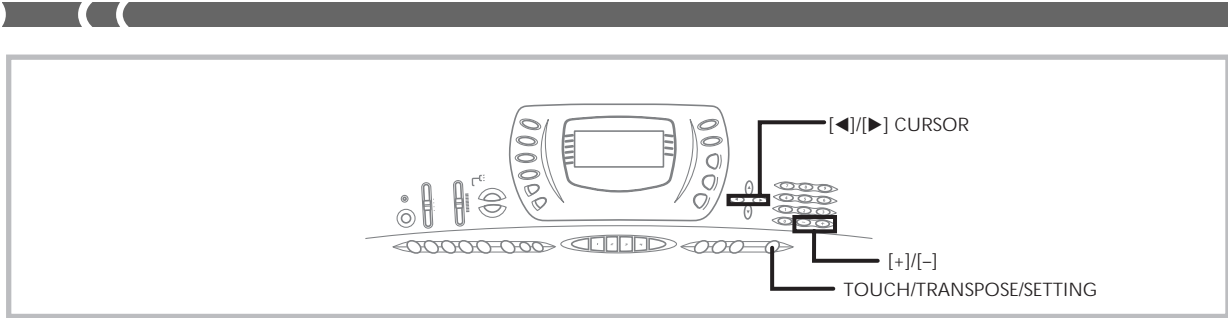

Transposing the Keyboard

Transpose lets you raise and lower the overall key of the keyboard in semitone units. If you want to play an accompaniment for a vocalist who sings in a key that's different from the keyboard, for example, simply use transpose to change the key of the keyboard.

To transpose the keyboard

1. Press the TOUCH/TRANSCOPE/SETTING button.
2. Press the [◀] and [▶] (CURSOR) buttons until the transpose screen appears on the display.



3. Use [+] and [-] to change the transpose setting of the keyboard.

Example: To transpose the keyboard five semitones upwards.



- Pressing the TOUCH/TRANSCOPE/SETTING button exits the transpose screen.

NOTE

- The keyboard can be transposed within a range of -24 (two octave downwards) to +24 (two octave upwards).
- The transpose setting also affects playback from song memory and Auto Accompaniment.

Tuning the Keyboard

The tuning feature lets you fine tune the keyboard to match the tuning of another musical instrument.

To tune the keyboard

1. Press the TOUCH/TRANSCOPE/SETTING button.
2. Use the [◀] and [▶] (CURSOR) buttons to display the tuning screen.



3. Use [+] and [-] to change the tuning setting of the keyboard.

Example: To lower the tuning by 20.



- Pressing the TOUCH/TRANSCOPE/SETTING button exits the transpose screen.

NOTE

- The keyboard can be tuned within a range of -99 cents to +99 cents.
*100 cents is equivalent to one semitone.
- The tuning setting also affects playback from song memory and Auto Accompaniment.

Changing Other Settings

Setting Types

The table below shows the parameters whose settings you can change.

Setting menu	Description	Page
Touch Response (Touch)	Specifies of how sound should change with keyboard pressure.	E-61
Transpose (Trans.)	Adjusts of overall keyboard tuning by semitone units.	E-62
Tune (Tune)	Fine adjustment of overall keyboard tuning.	E-62
Display/Pedal (LCD/Jack)	Adjusts display brightness and assigns of effects to pedals.	E-65
MIDI (MIDI)	MIDI settings	E-65
Initialize/Delete (Init/Del)	Initializes all settings to initial factory defaults, resets specific settings or deletes user rhythms.	E-65

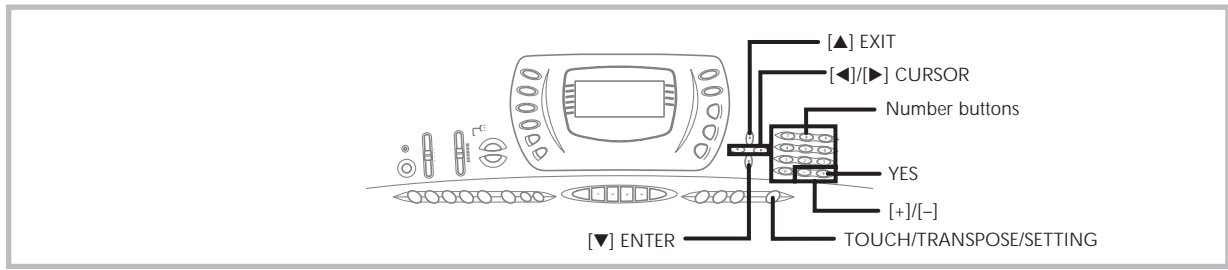

To use the keyboard settings menu

1. Press the TOUCH/TRANPOSE/SETTING button.
2. Use the [◀] and [▶] (CURSOR) buttons, and the [▲] (EXIT) and [▼] (ENTER) buttons to recall the items whose settings you want to change.

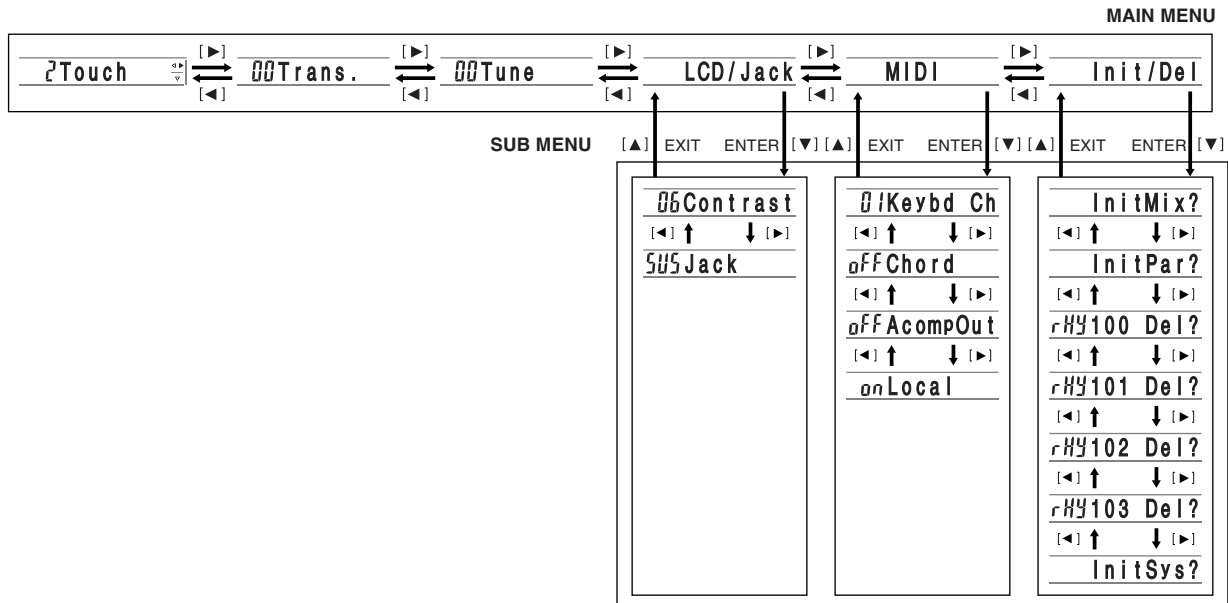

- 3-1. Use the [+] and [-] buttons or the number buttons to change the values.
 - Settings you make are applied even if you do not press the [▼] (ENTER) button.
 - See the following section titled "Setting Menu Items" for details on each setting.

■ In case of an initialize or delete procedure

- 3-2. Press the YES button.
 - This causes the message "Sure?" to appear, confirming whether you really want to perform the initialize or delete operation.
- 3-3. Press the YES button to complete the operation.
 - This performs the initialize or delete operation and returns to the tone or rhythm selection screen.
4. After making the settings you want, press the TOUCH/TRANPOSE/SETTING button or [▲] (EXIT) button to return to the tone or rhythm selection screen.

Setting Menu Items

Main menu	Sub menu	Range	Default	Description
Display/ Pedal (LCD/Jack)	Contrast (Contrast)	00 to 12	06	Adjusts display contrast.
	Assignable Jack (Jack)	SUS	SUS	Assigns the sustain pedal effect to a pedal.
		SoS	—	Assigns the sostenuto pedal effect to a pedal.
		SFt	—	Assigns the soft pedal effect to a pedal.
	rhy	—	Assigns the START/STOP button function to a pedal.	
MIDI (MIDI)	Keyboard Channel (Keybd Ch)	01 to 16	01	Specifies the send channel for main tone play.
	MIDI In Chord Judge (Chord)	on/oFF	oFF	Specifies whether accompaniment range MIDI Note On messages received from an external device should be interpreted as auto accompaniment chords.
	Accomp MIDI Out (AccompOut)	on/oFF	oFF	Specifies whether this keyboard's accompaniment is sent as MIDI messages.
	Local Control Setting (Local)	on/oFF	on	Specifies whether the keyboard should sound the parts played on it.
Initialize/ Delete (Init/Del)	Mixer Reset (InitMix?)	—	—	Initializes parameters assigned by the Mixer or by input from an external sequencer.
	Parameter Reset (InitPar?)	—	—	Initializes all parameters, except for the display contrast setting.
	User Rhythm No. 100 Delete (rHy 100 Del?)	—	—	Deletes user rhythm No. 100 data.
	User Rhythm No. 101 Delete (rHy 101 Del?)	—	—	Deletes user rhythm No. 101 data.
	User Rhythm No. 102 Delete (rHy 102 Del?)	—	—	Deletes user rhythm No. 102 data.
	User Rhythm No. 103 Delete (rHy 103 Del?)	—	—	Deletes user rhythm No. 103 data.
	System Delete (InitSys?)	—	—	Initializes to initial factory defaults. Deletes all data in the user area.

MIDI

What is MIDI?

The letters MIDI stand for Musical Instrument Digital Interface, which is the name of a worldwide standard for digital signals and connectors that make it possible to exchange musical data between musical instruments and computers (devices) produced by different manufacturers. MIDI compatible equipment can exchange keyboard key press, key release, tone change, and other data as messages.

Though you do not need any special knowledge about MIDI to use this keyboard as a stand-alone unit, MIDI operations require a bit of specialized knowledge. This section provides you with an overview of MIDI that will help to get you going.

MIDI Connections

MIDI messages are sent out through the MIDI OUT terminal of one device to the MIDI IN terminal of another machine over a MIDI cable. To send a message from this keyboard to another device, for example, you must use a MIDI cable to connect the MIDI OUT terminal of this keyboard to the MIDI IN terminal of the other device. To send MIDI messages back to this keyboard, you need to use a MIDI cable to connect the other device's MIDI OUT terminal to the MIDI IN terminal of this keyboard.

To use a computer or other MIDI device to record and playback the MIDI data produced by this keyboard, you must connect the MIDI IN and MIDI OUT terminals of both devices in order to send and receive data.

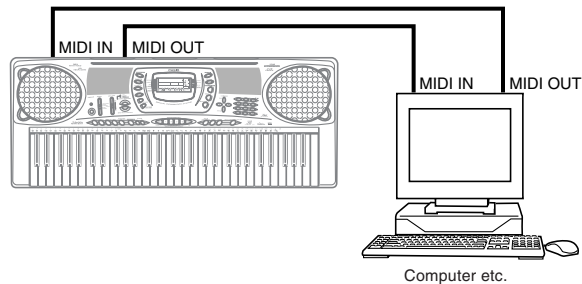

If a MIDI THRU function provided by the software is being run on a connected computer or other MIDI device, be sure to turn this keyboard's "Local Control Setting" off (page E-65).

MIDI Channels

MIDI allows you to send the data for multiple parts at the same time, with each part being sent over a separate MIDI channel. There are 16 MIDI channels, numbered 1 through 16, and MIDI channel data is always included whenever you exchange data (key press, pitch bend operation, etc.).

Both the sending device and the receiving machine must be set to the same channel for the receiving device to correctly receive and play data. If the receiving device is set to Channel 2, for example, it receives only MIDI Channel 2 data, and all other channels are ignored.

This keyboard is equipped with multi-timbre capabilities, which means it can receive messages over all 16 MIDI channels and play up to 16 parts at the same time. Tone and volume settings for each channel can be made using the keyboard's onboard Mixer, or by an external source that sends required MIDI control messages.

Keyboard operations performed on this keyboard is sent out by selecting a MIDI channel (1 to 16) and then sending the appropriate message.

General MIDI

General MIDI standardizes MIDI data for all sound source types, regardless of manufacturer. General MIDI specifies such factors as tone numbering, drum sounds, and available MIDI channels for all sound sources. This standard makes it possible for all MIDI equipment to reproduce the same nuances when playing General MIDI data, regardless of the manufacturer of the sound source.

This keyboard supports General MIDI, so it can be used to play commercially available pre-recorded General MIDI data and General MIDI data sent to it from a personal computer.

Sending and Receiving MIDI Messages

This keyboard can send notes you play on the keyboard, as well as auto accompaniment patterns and Song Memory playback as MIDI messages to another device.

MIDI Send Data

■ Keyboard Play

Each keyboard part (Channels 1 through 4) is sent over its own individual MIDI channel. When Auto Harmonize is turned on, harmonize notes are also sent over each individual MIDI channel.

■ Auto Accompaniment Play

Each accompaniment part is sent over its own individual MIDI channel. The "Accomp MIDI Out" parameter (page E-65) is used to specify whether a part is sent.

MIDI Message Receive

■ Multi Channel Receive

The 16 mixer parts can be used to receive data over 16 MIDI message channels at the same time.

■ Chord Changes when Using Auto Accompaniment

MIDI messages received from an external device can be interpreted as chord changes as specified by the fingerings supported by the auto accompaniment system of this keyboard. Use the "MIDI In Chord Judge" parameter (page E-65) to turn this capability on and off.

- See the MIDI Implementation Chart at the back of this User's Guide for more information about each MIDI message.

MIDI Settings

You can change the settings of a number of parameters that control how MIDI messages are sent and received.

MIDI Parameters

You can use the parameter setting procedure (page E-63) to change the settings of the MIDI parameters described below. See pages E-64 and E-65 for details about the setting menu and procedure.

■ MIDI In Chord Judge

This parameter determines whether note data received from an external device should be interpreted as an auto accompaniment chord fingering. Turn on this parameter when you want to control auto accompaniment chords from a computer or other external device.

- **on** Causes note data input through MIDI IN to be interpreted as auto accompaniment chord fingerings. The channel specified by the keyboard channel is used for specifying chords.
- **oFF** Turns off "MIDI In Chord Judge".

■ Accomp MIDI Out (Accompaniment MIDI Out)

Turn on this parameter when you want sound auto accompaniment on an external devices sound source.

- **on** Outputs auto accompaniment as MIDI messages through the keyboard's MIDI OUT terminal.
- **oFF** Does not output auto accompaniment.

■ NOTE

- For details, go to the CASIO Website at the URL below.
<http://world.casio.com>

Using the Data Download Service

Accompaniment, song, tone, DSP, and registration data, as well as application software for transferring data between your computer and the keyboard are all available for download at the [CASIO MUSIC SITE](http://music.casio.com/)*.

■ Data and Application Software

Data itself as well as application software for transferring data between your computer and the keyboard are available for download at the CASIO MUSIC SITE.

■ Application Software

You can run the application software on your computer and transfer data you download from the CASIO MUSIC SITE to the keyboard, and also use your computer's hard disk for long-term storage of data you transfer from the keyboard to your computer.

- See the instructions provided at the CASIO MUSIC SITE for full information about how to download the application software and data.
- See the application software's online help for information about how to use the software.

* CASIO MUSIC SITE

<http://music.casio.com/>

1. Go to the above URL.
2. Select a region or country.
3. Select a download service for the INTERNET DATA EXPANSION SYSTEM data.
 - Note that the service you should use depends on the area or country.

To connect to a computer

Be sure to turn off the keyboard and your computer before connecting them. You should also set the volume controller of the keyboard to a relatively low volume.

1. Connect the keyboard's MIDI interface to your computer's MIDI interface.

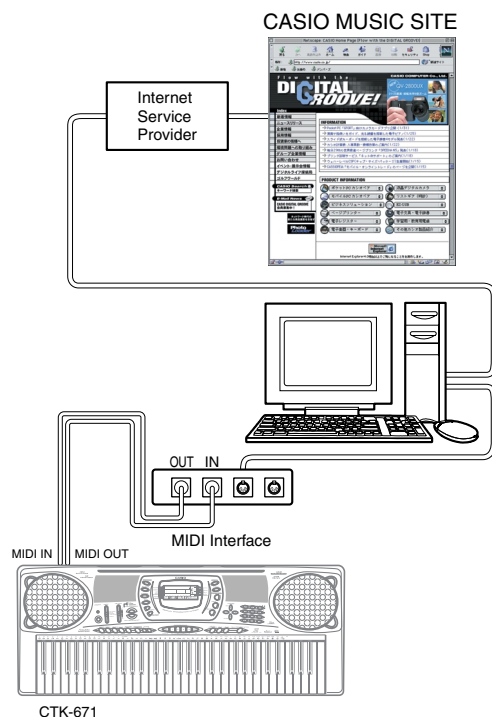

2. Turn on the keyboard, and then turn on your computer or other connected device.
3. Start up the software you want to use on your computer.

■ NOTE

- When using the application software, make sure that the tone setting screen (the screen that appears after turning on power) is on the keyboard's display screen.



Troubleshooting

Problem	Possible Cause	Action	See page
No keyboard Sound	<ol style="list-style-type: none"> 1. Power supply problem. 2. Power is not turned on. 3. Volume setting is too low. 4. The MODE switch is in the CASIO CHORD or FINGERED position. 5. Local Control is off. 6. Mixer channel 1 is turned off. 7. Mixer channel 1 volume setting is too low. 	<ol style="list-style-type: none"> 1. Correctly attach the AC adaptor, make sure that batteries poles (+/-) are facing correctly, and check to make sure that batteries are not dead. 2. Press the POWER button to turn on power. 3. Use the VOLUME slider to increase volume. 4. Normal play is not possible on the accompaniment keyboard while the MODE switch is set to CASIO CHORD or FINGERED. Change the MODE switch setting to NORMAL. 5. Turn on Local Control. 6. Use the Mixer to turn channel 1 on. 7. Use the Mixer to raise the volume setting for channel 1. 	<p>Page E-16</p> <p>Page E-21</p> <p>Page E-21</p> <p>Page E-29</p> <p>Page E-65</p> <p>Page E-35</p> <p>Page E-36</p>
<p>Any of the following symptoms while using battery power.</p> <ul style="list-style-type: none"> • Dim power indicator • Instrument does not turn on. • Display that is flickering, dim, or difficult to read • Abnormally low speaker/head-phone volume • Distortion of sound output • Occasional interruption of sound when playing at high volumes • Sudden power failure when playing at high volumes • Flickering or dimming of the display when playing at high volume • Continued sound output even after you release a key • A tone that is totally different from the one that is selected. • Abnormal rhythm pattern and demo tune play • Loss of power, sound distortion, or low volume when playing from a connected computer or MIDI device 	Low battery power	Replace the batteries with a set of new ones or use the AC adaptor.	Pages E-16, 17
Auto Accompaniment does not sound.	<ol style="list-style-type: none"> 1. Accompaniment volume is set to 000. 2. Auto Accompaniment part Channels 6 through 10 are turned off. 3. Auto Accompaniment part Channels 6 through 10 volume setting is too low. 	<ol style="list-style-type: none"> 1. Use the ACCOMP VOLUME button to increase the volume. 2. Use the Mixer to turn the channels on. 3. Use the Mixer to raise the volume setting for the applicable channel. 	<p>Page E-34</p> <p>Page E-35</p> <p>Page E-36</p>
Sound output does not change when key pressure is varied.	Touch response is turned off.	Press the TOUCH/TRANSCOPE/SETTING button to turn it on.	Page E-61
Playing the keyboard sounds two tones.	Layer is turned on.	Press the LAYER button to turn off layering.	Page E-59
Different tones sound when keys in different keyboard ranges are pressed.	Split is turned on.	Press the SPLIT button to turn off split.	Page E-59

Problem	Possible Cause	Action	See page
The key or tuning does not match when playing along with another MIDI machine.	<ol style="list-style-type: none"> 1. The tuning or transpose parameter is set to a value other than 00. 2. Mixer coarse tune, fine tune, and/or octave shift settings are values other than 00. 	<ol style="list-style-type: none"> 1. Change the transpose or tuning parameter value to 00. 2. Use the Mixer to change the coarse tune, fine tune, and/or octave shift settings to 00. 	<p>Page E-62</p> <p>Page E-37</p>
Parts suddenly drop out during song memory playback.	The number of tones being played at the same time exceeds the keyboard's limitation.	Use the Mixer to turn unneeded channels off and decrease the number of parts being played.	Page E-35
Some parts do not play at all during song memory playback.	<ol style="list-style-type: none"> 1. Channels are turned off. 2. Volume setting is too low. 	<ol style="list-style-type: none"> 1. Use the Mixer to turn channels on. 2. Use the Mixer to check the volume setting. 	<p>Page E-35</p> <p>Page E-36</p>
Cannot record Auto Accompaniment or rhythm.	A track other than Track 1 is selected as the recording track. Tracks 2 through 6 are melody tracks.	Use the track select buttons to select Track 1.	Page E-47
Nothing happens when the LAYER or SPLIT button is pressed.	<ol style="list-style-type: none"> 1. One or more of the melody channels (2 through 4) is turned off. 2. The volume setting of one or more of the melody channels (2 through 4) is too low. 3. The keyboard is in record standby. 	<ol style="list-style-type: none"> 1. Use the Mixer to turn on Channels 2 through 4. 2. Use the Mixer to raise the volume setting of Channels 2 through 4. 3. The LAYER and SPLIT buttons are disabled during recording and record standby. 	<p>Page E-35</p> <p>Page E-36</p> <p>Page E-46</p>
No sound is produced when playing MIDI data from a computer.	<ol style="list-style-type: none"> 1. MIDI cables are not connected properly. 2. Channel is turned off, or volume setting is too low. 	<ol style="list-style-type: none"> 1. Connect MIDI cables properly. 2. Use the Mixer to turn the channel on, or raise the volume setting. 	<p>Page E-66</p> <p>Pages E-35, 36</p>
Playing on the keyboard produces an unnatural sound when connected to a computer.	The computer's MIDI Thru function is turned on.	Turn off the MIDI Thru function on the computer or turn off Local Control on the keyboard.	Page E-65
Cannot record chord accompaniment data on a computer.	Accomp MIDI Out is turned off.	Turn on Accomp MIDI Out.	Page E-65



Specifications

Model:	CTK-671														
Keyboard:	61 standard-size keys, 5 octaves with touch response (Off / Light / Normal / Heavy)														
Tones:	348 total (100 panel tones + 128 GM tones + 10 drum sounds + 10 user tones + 100 Advanced Tones); layer/split														
Rhythm Instrument Tones:	61														
Polyphony:	32 notes maximum (16 for certain tones)														
Effects:	DSP (110 types: internal, 10 user areas) + Reverb (16 types) + Chorus (16 types)														
Equalizer:	10 types, 4 bands														
Auto Accompaniment															
Rhythm Patterns:	104 (internal, 4 user areas)														
Tempo:	Variable (226 steps, ♩ = 30 to 255)														
Chords:	3 fingering methods (CASIO CHORD, FINGERED, FULL RANGE CHORD)														
Rhythm Controller:	START/STOP, INTRO/ENDING 1 and 2, VARIATION/FILL-IN 1 and 2, SYNCHRO/FILL-IN NEXT														
Accomp Volume:	0 to 127 (128 steps)														
One-touch Presets:	Recalls settings for tone, tempo, layer on/off, and harmonize on/off in accordance with rhythm.														
Auto Harmonize:	Automatic addition of notes that harmonize with melody note in accordance with specified Auto Accompaniment chords.														
Memory Function															
Songs:	2														
Recording Tracks:	6 (2 through 6 are melody tracks)														
Recording Methods:	Real-time, step														
Memory Capacity:	Approximately 3,500 notes (total for two songs) * Same memory is shared for user rhythm storage.														
Edit Function:	Equipped														
Demo Tunes:	2														
	<table border="1"> <thead> <tr> <th>Tune Number</th> <th>Name</th> <th>Composer</th> <th>Play Time</th> </tr> </thead> <tbody> <tr> <td>0</td> <td>Crystal Fountain</td> <td>Edward Alstrom</td> <td>1:54</td> </tr> <tr> <td>1</td> <td>Night Breeze</td> <td>Hage Software</td> <td>1:52</td> </tr> </tbody> </table>	Tune Number	Name	Composer	Play Time	0	Crystal Fountain	Edward Alstrom	1:54	1	Night Breeze	Hage Software	1:52		
Tune Number	Name	Composer	Play Time												
0	Crystal Fountain	Edward Alstrom	1:54												
1	Night Breeze	Hage Software	1:52												
Synthesizer Function															
Parameters:	Attack time; release time; resonance; cutoff frequency; vibrato type; vibrato delay; vibrato depth; vibrato rate; octave shift; level; touch sense; reverb send; chorus send; DSP line; DSP type and DSP parameter														
Registration Memory															
Number of Setups:	16 (4 setups x 4 banks)														
Memory Contents:	Tone select, Rhythm select, Tempo settings, Split on/off, Split point settings, Layer on/off, Mixer settings (Channels 1~10), Effect settings, Equalizer settings, Touch Response settings, Assignable jack setting, Transpose settings, Tuning settings, Accompaniment volume settings, Harmonize on/off														

Mixer Function Channels: Parameters:	16 Channel on/off; tone; part on/off; volume; pan pot; octave shift; coarse tune; fine tune; reverb send; chorus send; DSP line
MIDI:	16 multi-timbre receive, GM Level 1 standard
Other Functions Transpose: Tuning: LCD:	49 steps (-24 semitones to +24 semitones) Variable (A4 = approximately 440Hz ±100 cents) Adjustable contrast
Terminals MIDI Terminals: Sustain/ Assignable Terminal: Headphone/Output Terminal: Power Supply Terminal:	IN, OUT Standard jack (sustain, sostenuto, soft, rhythm start/stop) Stereo standard jack Output Impedance: 140Ω Output Voltage: 4.5V (RMS) MAX 9V DC
Power Supply: Batteries: Battery Life: AC Adaptor: Auto Power Off:	Dual power supply system 6 D-size batteries Approximately 4 hours continuous operation on manganese batteries AD-5 Turns power off approximately six minutes after last key operation. Enabled under battery power only, can be disabled manually.
Speaker Output:	2.5W + 2.5W
Power consumption:	9V --- 7.7W
Dimensions:	96.0 x 37.5 x 14.7 cm (37 ¹³ / ₁₆ x 14 ³ / ₄ x 5 ¹³ / ₁₆ inch)
Weight:	Approximately 5.8 kg (12.8lbs) (without batteries)

Appendix/Apéndice

Tone List Panel Tones

Lista de sonidos Sonidos de panel

No.	Tone Group	Tone Name	Program Change	Bank Select MSB	Maximum Polyphony	Range Type	DSP Type
Nº	Grupo de sonido	Nombre de sonido	Cambio de programa	MSB de selección de banco	Polyfonia máxima	Tipo de gama	Tipo DSP
0	PIANO	GRAND PIANO	0	65	32	N	-
1		GRAND PIANO WIDE	0	67	16	N	-
2		MELLOW PIANO	0	66	32	N	-
3		BRIGHT PIANO	1	65	32	N	-
4		MODERN PIANO	1	66	16	N	-
5		HONKY-TONK	3	65	16	N	-
6		ELEC.GRAND PIANO	2	65	32	N	-
7		ELEC.PIANO	4	65	32	N	-
8		MODERN E.PIANO	5	65	16	N	-
9		GLASS E.PIANO	4	66	16	N	-
10		SOFT E.PIANO	5	66	16	N	-
11		HARPSICHORD	6	65	32	N	-
12		CLAVI	7	65	32	N	-
13	CHROMATIC PERC	CELESTA	8	65	32	N	-
14		GLOCKENSPIEL	9	65	32	1	-
15		VIBRAPHONE	11	65	32	N	-
16		MARIMBA	12	65	32	N	-
17	ORGAN	DRAWBAR ORGAN 1	16	65	16	N	-
18		DRAWBAR ORGAN 2	16	66	32	N	-
19		PERC.ORGAN 1	17	65	16	N	-
20		PERC.ORGAN 2	17	66	16	N	-
21		ELEC.ORGAN	16	67	32	N	-
22		JAZZ ORGAN	17	67	16	N	-
23		ROCK ORGAN	18	65	16	N	-
24		CHURCH ORGAN	19	65	16	N	-
25		ACCORDION	21	65	16	N	-
26		BANDONEON	23	65	16	N	-
27		HARMONICA	22	65	32	N	-
28	GUITAR	NYLON STR.GUITAR	24	65	32	-1	-
29		STEEL STR.GUITAR	25	65	32	-1	-
30		12 STR.GUITAR	25	66	16	-1	-
31		JAZZ GUITAR	26	65	32	-1	-
32		CLEAN GUITAR	27	65	32	-1	-
33		ELEC.GUITAR	27	66	32	-1	-
34		MUTE GUITAR	28	65	32	-1	-
35		OVERDRIVE GT	29	65	32	-1	-
36		DISTORTION GT	30	65	32	-1	-
37		FEEDBACK GT	30	66	16	-1	-
38		BANJO	105	65	32	N	-
39	BASS	ACOUSTIC BASS	32	65	32	-1	-
40		FINGERED BASS	33	65	32	-1	-
41		PICKED BASS	34	65	32	-1	-
42		FRETLESS BASS	35	65	32	-1	-
43		SLAP BASS	37	65	32	-1	-
44		SAW SYNTH+BASS	38	65	16	-1	-
45		SQR SYNTH+BASS	39	65	32	-1	-
46	STR/ORCHESTRA	VIOLIN	40	65	32	N	-
47		CELLO	42	65	32	-1	-
48		PIZZICATO STRINGS	45	65	32	N	-
49		HARP	46	65	32	N	-
50	ENSEMBLE	STRINGS	48	65	32	N	-
51		SLOW STRINGS	49	65	32	N	-
52		BRIGHT STRINGS	48	66	32	N	-
53		MELLOW STRINGS	49	66	32	N	-
54		SYNTH-STRINGS	50	65	32	N	-
55		RESO SYNTH-STRINGS	51	65	32	N	-

No.	Tone Group	Tone Name	Program Change	Bank Select MSB	Maximum Polyphony	Range Type	DSP Type
Nº	Grupo de sonido	Nombre de sonido	Cambio de programa	MSB de selección de banco	Polyfonía máxima	Tipo de gama	Tipo DSP
91		WARFAM PAD	89	65	32	N	-
92		POLYSYNTH	90	65	16	N	-
93		BOWED GLASS	92	65	16	N	-
94		HALO PAD	94	65	16	N	-
95		SWEEP PAD	95	65	32	N	-
96		RAIN DROP	96	65	16	N	-
97		CRYSTAL	98	65	16	N	-
98		ATMOSPHERE	99	65	16	N	-
99		BRIGHTNESS	100	65	16	N	-

No.	Tone Group	Tone Name	Program Change	Bank Select MSB	Maximum Polyphony	Range Type	DSP Type
Nº	Grupo de sonido	Nombre de sonido	Cambio de programa	MSB de selección de banco	Polyfonía máxima	Tipo de gama	Tipo DSP
56		CHOIR AAHS	52	65	32	N	-
57		VOICE DOO	53	65	32	N	-
58		SYNTH-VOICE	54	65	32	N	-
59		ORCHESTRA HIT	55	65	16	N	-
60	BRASS	TRUMPET	56	65	32	N	-
61		TROMBONE	57	65	32	-1	-
62		TUBA	58	65	32	-1	-
63		MUTE TRUMPET	59	65	32	N	-
64		FRENCH HORN	60	65	16	-1	-
65		BRASS SECTION	61	65	32	N	-
66		OCTAVE BRASS	61	66	16	N	-
67		BRASS+SYNTH	61	67	16	N	-
68		ANALOG SYNTH-BRASS	62	65	32	N	-
69		VINTAGE SYNTH-BRASS	63	65	16	N	-
70	REED	SOPRANO SAX	64	65	32	N	-
71		ALTO SAX	65	65	32	-1	-
72		BREATHY A. SAX	65	66	16	-1	-
73		TENOR SAX	66	65	32	-1	-
74		BREATHY T. SAX	66	66	16	-1	-
75		BARITONE SAX	67	65	32	-1	-
76		OBOE	68	65	32	N	-
77		CLARINET	71	65	32	N	-
78	PIPE	PICCOLO	72	65	32	1	-
79		FLUTE	73	65	32	N	-
80		MELLOW FLUTE	73	66	16	N	-
81		RECORDER	74	65	32	N	-
82		PAN FLUTE	75	65	32	N	-
83		WHISTLE	78	65	32	N	-
84	SYNTH-LEAD	SQUARE LEAD	80	65	16	N	-
85		SAWTOOTH LEAD	81	65	16	N	-
86		CALLIOPE	82	65	16	N	-
87		VOICE LEAD	85	65	16	N	-
88		FIFTH LEAD	86	65	16	N	-
89		BASS+LEAD	87	65	16	N	-
90	SYNTH-PAD	FANTASY	88	65	16	N	-

Advanced Tones Sonidos avanzados

No.	Tone Group	Tone Name	Program Change	Bank Select MSB	Maximum Polyphony	Range Type	DSP Type
Nº	Grupo de sonido	Nombre de sonido	Cambio de programa	MSB de selección de banco	Polyfonía máxima	Tipo de gama	Tipo DSP
0	PIANO	STEREO PIANO	0	68	32	N	Reflect
1		SYNTH-STR.PIANO	0	70	16	N	Reflect
2		VOICE PIANO	0	69	16	N	Reflect
3		STRINGS PIANO	1	68	16	N	Reflect
4		DANCE PIANO	1	69	16	N	EnhDly
5		60'S OCTAVE PIANO	3	68	16	N	Equalize
6		MODERN E.G.PIANO	2	68	16	N	ChoDly1
7		TREMOLO E.PIANO	4	68	32	N	ChoTrem
8		SYNTH-STR.E.PIANO	5	68	16	N	Reflect
9		E.PIANO PAD	4	69	16	N	SPhase
10		STRINGS E.PIANO	5	69	16	N	ChoDly3
11		COUPLED HARPICHOORD	6	68	16	N	CmpChoRf
12		RESONANCE CLAVI	7	68	32	N	AutoWah
13	CHROMATIC PERC	DELAY CELESTA	8	68	32	N	3TapDly
14		DELAY GLOCKENSPIEL	9	68	32	1	Delay
15		TREMOLO VIBRAPHONE	11	68	32	N	ChoTrem
16		PHASER MARIMBA	12	68	32	N	PhaDly2
17	ORGAN	ROTARY DRAWBAR	16	68	32	N	RotRef1
18		OVD ROTARY ORGAN	16	69	32	N	OvdRot2
19		ROTARY PERC.ORGAN 1	17	68	16	N	RotRef2
20		ROTARY PERC.ORGAN 2	17	69	16	N	RotRef3
21		ROTARY ELEC.ORGAN	16	70	32	N	Rotary2
22		JAZZ DRAWBAR	17	70	32	N	Rotary1
23		OVD ROCK ORGAN	18	68	16	N	OvdRRef1
24		PURE CHURCH ORGAN	19	68	16	N	Reflect
25		OCTAVE ACCORDION	21	68	16	N	CmpChoRf
26		NEO BANDONEON	23	68	16	N	ChoDly4
27		SLOW HARMONICA	22	68	32	N	Room2
28	GUITAR	MELLOW NYLON GUITAR	24	68	16	-1	ChoDly3
29		ENHANCED STEEL GUITAR	25	68	16	-1	EnhDly
30		CHORUS STEEL GUITAR	25	69	32	-1	ChoDly4
31		OCT JAZZ GUITAR	26	68	16	-1	Room3
32		CHORUS CLEAN GUITAR	27	68	32	-1	ChoDly4
33		CRUNCH ELEC.GUITAR	27	69	32	-1	CrnDelay
34		MUTED DIST GUITAR	28	68	32	-1	MetaDly
35		AUTO WAH OVERDRIVE GT	29	68	32	-1	AWHvOvDly
36		MORE DISTORTION GT	30	68	32	-1	DistDly2
37		FEEDBACK DIST.GT	30	69	16	-1	DistDly1
38		OCT BANJO	105	68	16	N	ChoDly2
39	BASS	RIDE BASS	32	68	16	-1	Room1
40		CHORUS FING. BASS	33	68	16	-1	CrnCho
41		COMP.PICKED BASS	34	68	16	-1	CmpEnDly
42		FLAN.FRETLESS BASS	35	68	16	-1	ChoFlan
43		MORE SLAP BASS	37	68	16	-1	EnhFlan
44		ADVANCED SYNTH-BASS 1	38	68	32	-1	AWvDly
45		ADVANCED SYNTH-BASS 2	39	68	16	-1	CrnLofi
46	STR/ORCHESTRA	SLOW VIOLIN	40	68	32	N	Room2
47		SLOW CELLO	42	68	32	-1	SXDdelay
48		PIZZICATO ENSEMBLE	45	68	16	N	ChoDly4
49		HARPS	46	68	16	N	3TapDly
50	ENSEMBLE	STEREO STRINGS	48	68	16	N	Reflect
51		CHAMBER	49	68	16	N	Reflect
52		ORCHESTRA STRINGS 1	48	69	16	N	Reflect
53		ORCHESTRA STRINGS 2	49	69	16	N	ChoDly3
54		PURE SYNTH-STRINGS	50	68	16	N	ChoDly3
55		PHASER SYNTH-STR	51	68	16	N	PhaAPan2
56		CHOIRS	52	68	16	N	Reflect
57		SYNTH-DOO	53	68	16	N	DistDly1
58		SYNTH-VOICE PAD	54	68	16	N	FlanDly1
59		TIMPANI HIT	55	68	16	N	GateRvb2
60	BRASS	VELO.TRUMPET	56	68	32	N	EnhDly
61		TROMBONE SECTION	57	68	16	-1	ChoDly1

No.	Tone Group	Tone Name	Program Change	Bank Select MSB	Maximum Polyphony	Range Type	DSP Type
Nº	Grupo de sonido	Nombre de sonido	Cambio de programa	MSB de selección de banco	Polyfonía máxima	Tipo de gama	Tipo DSP
97		NEW CRYSTAL	98	68	16	N	ChoDiy4
98		STAR THEME	99	68	16	N	PhaAPan2
99		BRIGHTER	100	68	16	N	ChoDiy3

No.	Tone Group	Tone Name	Program Change	Bank Select MSB	Maximum Polyphony	Range Type	DSP Type
Nº	Grupo de sonido	Nombre de sonido	Cambio de programa	MSB de selección de banco	Polyfonía máxima	Tipo de gama	Tipo DSP
62		STACK TUBA	58	68	16	-1	CmpEnDly
63		WAH MUTE TRUMPET	59	68	32	N	AwCrDly
64		OCT FRENCH HORN	60	68	16	-1	ChoDiy3
65		STEREO BRASS	61	68	16	N	EnhaDly
66		TRUMPET + BRASS	61	69	16	N	Plate1
67		BRASS SFZ	61	70	16	N	EnhaDly
68		DEEP SYNTH-BRASS	62	68	16	N	EnhaDly
69		SLOW SYNTH-BRASS	63	68	16	N	ChoDiy4
70	REED	MELLOW S. SAX	64	68	16	N	Reflect
71		A. SAXYS	65	68	16	-1	EnhaDly
72		VELO.ALTO SAX	65	69	16	-1	Hall2
73		T.SAXYS	66	68	16	-1	Hall2
74		VELO.TENOR SAX	66	69	16	-1	Hall2
75		STACK BARTONE SAX	67	68	16	-1	OdDelay
76		SYNTH-OBOE	68	68	16	N	ChoDiy4
77		VELO.CLARINET	71	68	16	N	Room3
78	PIPE	PICCOLO ENSEMBLE	72	68	16	1	Reflect
79		FLUTE + REED	73	68	16	N	SXDelay
80		VELO.FLUTE	73	69	16	N	EnhaDly
81		SYNTH-RECORDER	74	68	16	N	ChoDiy4
82		SYNTH-PAN FLUTE	75	68	16	N	AWhChDly
83		WHISTLES	78	68	16	N	ChoDiy4
84	SYNTH-LEAD	MELLOW SQR LEAD	80	68	16	N	ChoDiy1
85		MELLOW SAW/LEAD	81	68	16	N	ChoDiy2
86		ADVANCED CALLIOPE	82	68	16	N	ChoDiy2
87		VOX LEAD	85	68	16	N	FianDiy2
88		4TH LEAD	86	68	16	N	SDelay
89		FRET LEAD	87	68	16	N	EnhaDly
90	SYNTH-PAD	NEW FANTASY	88	68	16	N	ChoDiy3
91		WARM VOX	89	68	16	N	AWhChDly
92		POLY SAW	90	68	16	N	ChoDiy3
93		BOWED PAD	92	68	16	N	ChoDiy4
94		SPACE VOX	94	68	16	N	RotRef1
95		MOVIE SOUND	95	68	16	N	FianDiy1
96		NEW GOBLIN	96	68	16	N	RgChoDly

GM Tones Sonidos GM

No.	Tone Group	Tone Name	Program Change	Bank Select MSB	Maximum Polyphony	Range Type	DSP Type
Nº	Grupo de sonido	Nombre de sonido	Cambio de programa	MSB de selección de banco	Polyfonía máxima	Tipo de gama	Tipo DSP
100	PIANO	Piano 1	0	0	32	N	-
101		Piano 2	1	0	32	N	-
102		Piano 3	2	0	32	N	-
103		HONKY-TONK GM	3	0	16	N	-
104		E.PIANO 1	4	0	32	N	-
105		E.PIANO 2	5	0	16	N	-
106		HARPSICHORD GM	6	0	32	N	-
107		CLAVI GM	7	0	32	N	-
108	CHROMATIC PERC	CELESTA GM	8	0	32	N	-
109		GLOCKENSPIEL OCT	9	0	32	N	-
110		MUSIC BOX	10	0	16	N	-
111		VIBRAPHONE GM	11	0	32	N	-
112		MARIMBA GM	12	0	32	N	-
113		XYLOPHONE	13	0	32	N	-
114		TUBULAR BELL	14	0	32	N	-
115		DULCIMER	15	0	16	N	-
116	ORGAN	ORGAN 1	16	0	16	N	-
117		ORGAN 2	17	0	16	N	-
118		ORGAN 3	18	0	16	N	-
119		PIPE ORGAN	19	0	16	N	-
120		REED ORGAN	20	0	32	N	-
121		FRENCH ACCORDION	21	0	16	N	-
122		HARMONICA GM	22	0	32	N	-
123		BANDONEON GM	23	0	16	N	-
124	GUITAR	NYLON STR.GUITAR OCT	24	0	32	N	-
125		STEEL STR.GUITAR OCT	25	0	32	N	-
126		JAZZ GUITAR OCT	26	0	32	N	-
127		CLEAN GUITAR OCT	27	0	32	N	-
128		MUTE GUITAR OCT	28	0	32	N	-
129		OVERDRIVE GT OCT	29	0	32	N	-
130		DISTORTION GT OCT	30	0	32	N	-
131		GT HARMONICS	31	0	32	N	-
132	BASS	ACOUSTIC BASS OCT	32	0	32	N	-
133		FINGERED BASS OCT	33	0	32	N	-
134		PICKED BASS OCT	34	0	32	N	-
135		FRETLESS BASS OCT	35	0	32	N	-
136		SLAP BASS 1 OCT	36	0	32	N	-
137		SLAP BASS 2 OCT	37	0	32	N	-
138		SYNTH-BASS 1 OCT	38	0	16	N	-
139		SYNTH-BASS 2 OCT	39	0	32	N	-
140	STR/ORCHESTRA	VIOLIN GM	40	0	32	N	-
141		VIOLA	41	0	32	N	-
142		CELLO GM	42	0	32	N	-
143		CONTRABASS	43	0	32	N	-
144		TREMOLLO STRINGS	44	0	32	N	-
145		PIZZICATO GM	45	0	32	N	-
146		HARP GM	46	0	32	N	-
147		TIMPANI	47	0	32	N	-
148	ENSEMBLE	ORCHESTRA STRINGS 1	48	0	32	N	-
149		ORCHESTRA STRINGS 2	49	0	32	N	-
150		SAW.SYNTH-STRINGS 1	50	0	32	N	-
151		SAW.SYNTH-STRINGS 2	51	0	32	N	-
152		VOICE AHH	52	0	32	N	-
153		VOCAL DOO	53	0	32	N	-
154		SYNTH-VOX	54	0	32	N	-
155		ORCHESTRA HIT GM	55	0	16	N	-
156	BRASS	TRUMPET GM	56	0	32	N	-
157		TROMBONE OCT	57	0	32	N	-
158		TUBA OCT	58	0	32	N	-
159		MUTE TRUMPET GM	59	0	32	N	-
160		FRENCH HORN OCT	60	0	16	N	-
161		BRASS	61	0	32	N	-
162		SYNTH-BRASS 1	62	0	32	N	-
163		SYNTH-BRASS 2	63	0	16	N	-
164	REED	SOPRANO SAX GM	64	0	32	N	-
165		ALTO SAX OCT	65	0	32	N	-
166		TENOR SAX OCT	66	0	32	N	-
167		BARITONE SAX OCT	67	0	32	N	-

No.	Tone Group	Tone Name	Program Change	Bank Select MSB	Maximum Polyphony	Range Type	DSP Type
Nº	Grupo de sonido	Nombre de sonido	Cambio de programa	MSB de selección de banco	Polyfonía máxima	Tipo de gama	Tipo DSP
168		OBOE GM	68	0	32	N	-
169		ENGLISH HORN	69	0	32	N	-
170		BASSOON	70	0	32	N	-
171		CLARINET GM	71	0	32	N	-
172	PIPE	PICCOLO OCT	72	0	32	N	-
173		FLUTE GM	73	0	32	N	-
174		RECORDER GM	74	0	32	N	-
175		PAN FLUTE GM	75	0	32	N	-
176		BOTTLE BLOW	76	0	16	N	-
177		SHAKUHACHI	77	0	16	N	-
178		WHISTLE GM	78	0	32	N	-
179		OCARINA	79	0	32	N	-
180	SYNTH-LEAD	SQUARE WAVE	80	0	16	N	-
181		SAWTOOTH WAVE	81	0	16	N	-
182		CALLIOPE LEAD	82	0	16	N	-
183		CHIFF LEAD	83	0	16	N	-
184		CHARANG	84	0	16	N	-
185		SOLO VOX	85	0	16	N	-
186		FIFTH SAW	86	0	16	N	-
187		BASS LEAD	87	0	16	N	-
188	SYNTH-PAD	NEW AGE	88	0	16	N	-
189		WARM SYNTH	89	0	32	N	-
190		POLY SYNTH GM	90	0	16	N	-
191		SPACE CHOIR	91	0	16	N	-
192		BOWED PAD	92	0	16	N	-
193		METAL PAD	93	0	16	N	-
194		HALO SYNTH	94	0	16	N	-
195		SWEEP SYNTH	95	0	32	N	-
196	SYNTH-SFX	RAIN PAD	96	0	16	N	-
197		SOUND TRACK	97	0	16	N	-
198		CRYSTAL PAD	98	0	16	N	-
199		ATMOSPHERE PAD	99	0	16	N	-
200		BRIGHT PAD	100	0	16	N	-
201		GOBLINS	101	0	16	N	-
202		ECHOES	102	0	32	N	-
203		SF	103	0	16	N	-
204	ETHNIC	SITAR	104	0	16	N	-
205		BANJO GM	105	0	32	N	-

No.	Tone Group	Tone Name	Program Change	Bank Select MSB	Maximum Polyphony	Range Type	DSP Type
Nº	Grupo de sonido	Nombre de sonido	Cambio de programa	MSB de selección de banco	Polyfonía máxima	Tipo de gama	Tipo DSP
206		SHAMISEN	106	0	32	N	-
207		KOTO	107	0	32	N	-
208		THUMB PIANO	108	0	32	N	-
209		BAG PIPE	109	0	16	N	-
210		FIDDLE	110	0	32	N	-
211		SHANAI	111	0	32	N	-
212		TINKLE BELL	112	0	32	N	-
213	PERCUSSIVE	AGOGO	113	0	32	N	-
214		STEEL DRUMS	114	0	16	N	-
215		WOOD BLOCK	115	0	32	1/2	-
216		TAIKO	116	0	32	1/2	-
217		MELODIC TOM	117	0	32	1/2	-
218		SYNTH-DRUM	118	0	32	1/2	-
219		REVERSE CYMBAL	119	0	32	1/2	-
220	SOUND EFFECTS	GT FRET NOISE	120	0	32	N	-
221		BREATH NOISE	121	0	32	N	-
222		SEASHORE	122	0	16	1/4	-
223		BIRD	123	0	16	1/4	-
224		TELEPHONE	124	0	32	1/4	-
225		HELICOPTER	125	0	32	1/4	-
226		APPLAUSE	126	0	16	1/4	-
227		GUNSHOT	127	0	32	N	-

■ NOTE
Range

Symbol	Meaning
N	Normal
-1	1 Octave Down
-2	2 Octave Down
1	1 Octave Up
2	2 Octave Up
1/2	1/2 Octave
1/4	1/4 Octave

■ NOTE
Gama

Simbolo	Significado
N	Normal
-1	1 Octava hacia abajo
-2	2 Octavas hacia abajo
1	1 Octava hacia arriba
2	2 Octavas hacia arriba
1/2	1/2 Octava
1/4	1/4 de Octava

Drum Sounds

Sonidos de batería

No.	Tone Group	Tone Name	Program Change	Bank Select MSB
Nº	Grupo de sonido	Nombre de sonido	Cambio de programa	MSB de selección de banco
228		STANDARD SET 1	0	120
229		STANDARD SET 2	1	120
230		ROOM SET	8	120
231		POWER SET	16	120
232		ELECTRONIC SET	24	120
233		SYNTH SET 1	25	120
234		SYNTH SET 2	30	120
235		JAZZ SET	32	120
236		BRUSH SET	40	120
237		ORCHESTRA SET	48	120

User Tones

Sonidos del usuario

No.	Tone Group	Tone Name	Program Change	Bank Select MSB
Nº	Grupo de sonido	Nombre de sonido	Cambio de programa	MSB de selección de banco
238		User 01	0	71
239		User 02	1	71
240		User 03	2	71
241		User 04	3	71
242		User 05	4	71
243		User 06	5	71
244		User 07	6	71
245		User 08	7	71
246		User 09	8	71
247		User 10	9	71

Drum Assignment List (← Indicates the same sound as STANDARD SET)

Lista de asignación de batería (← Indica el mismo sonido que STANDARD SET)

Key/Note number Clave/ Número de nota		Program Change No. / Drum Set Name / Número de cambio de programa / Nombre de ajuste de batería												
0: STANDARD SET 1		11: STANDARD SET 2	8: ROOM SET	16: POWER SET	24: ELEC SET	25: SYNTH 1	30: SYNTH 2	32: JAZZ SET	40: BRUSH SET	48: ORCHESTRA SET				
E1	27	HIGH Q	←	←	←	←	←	←	←	←				
E1	28	SLAP	←	←	←	←	←	←	←	←				
F1	29	SCRATCH PUSH	←	←	←	←	←	←	←	←				
G1	30	SCRATCH PULL	←	←	←	←	←	←	←	←				
G1	31	STICKS	←	←	←	←	←	←	←	←				
A1	32	SQUARE CLICK	←	←	←	←	←	←	←	←				
A1	33	METRONOME CLICK	←	←	←	←	←	←	←	←				
B1	34	METRONOME BELL	←	←	←	←	←	←	←	←				
B1	35	STANDARD 1 KICK 2	ROOM KICK 2	POWER KICK 2	ELEC KICK 2	SYNTH 1 KICK 1	SYNTH 2 KICK 1	JAZZ KICK 2	JAZZ KICK 2	JAZZ KICK 1				
C2	36	STANDARD 1 KICK 1	ROOM KICK 1	POWER KICK 1	ELEC KICK 1	SYNTH 1 KICK 2	SYNTH 2 KICK 2	JAZZ KICK 1	JAZZ KICK 1	←				
C2	37	SIDE STICK	←	←	←	←	←	←	←	←				
D2	38	STANDARD 1 SNARE 1	ROOM SNARE 1	POWER SNARE 1	ELEC SNARE 1	SYNTH 1 SNARE 1	SYNTH 2 SNARE 1	JAZZ SNARE 1	BRUSH TAP	←				
E2	39	HAND CLAP	ROOM SNARE 2	POWER SNARE 2	ELEC SNARE 2	SYNTH HAND CLAP	←	←	BRUSH SLAP	←				
E2	40	STANDARD 1 SNARE 2	ROOM SNARE 2	POWER SNARE 2	ELEC SNARE 2	SYNTH 1 SNARE 2	SYNTH 2 SNARE 2	JAZZ SNARE 2	BRUSH SWIRL	←				
F2	41	LOW TOM 2	ROOM LOW TOM 2	ROOM LOW TOM 2	ELEC LOW TOM 2	SYNTH 1 LOW TOM 2	←	←	←	←				
G2	42	CLOSED HI-HAT	←	←	←	←	←	←	←	←				
G2	43	LOW TOM 1	ROOM LOW TOM 1	ROOM LOW TOM 1	ELEC LOW TOM 1	SYNTH 1 LOW TOM 1	←	←	←	←				
A2	44	PEDAL HI-HAT	←	←	←	←	←	←	←	←				
A2	45	MID TOM 2	ROOM MID TOM 2	ROOM MID TOM 2	ELEC MID TOM 2	SYNTH 1 MID TOM 2	←	←	←	←				
B2	46	OPEN HI-HAT	←	←	←	←	←	←	←	←				
C3	47	MID TOM 1	ROOM MID TOM 1	ROOM MID TOM 1	ELEC MID TOM 1	SYNTH 1 OHH	←	←	←	←				
C3	48	HIGH TOM 2	ROOM HI TOM 2	ROOM HI TOM 2	ELEC HI TOM 2	SYNTH 1 MID TOM 1	←	←	←	←				
C3	49	CRASH CYMBAL 1	ROOM HI TOM 1	ROOM HI TOM 1	ELEC HI TOM 1	SYNTH 1 HI TOM 2	←	←	←	←				
D3	50	HIGH TOM 1	ROOM HI TOM 1	ROOM HI TOM 1	ELEC HI TOM 1	SYNTH 1 HI TOM 1	←	←	←	←				
E3	52	CHINESE CYMBAL	←	←	←	←	←	←	←	←				
F3	53	RIDE BELL	←	←	←	←	←	←	←	←				
F3	54	TAMBOURINE	←	←	←	←	←	←	←	←				
G3	55	SPLASH CYMBAL	←	←	←	←	←	←	←	←				
A3	56	COINBELL	←	←	←	←	←	←	←	←				
A3	57	CRASH CYMBAL 2	←	←	←	←	←	←	←	←				
B3	58	VIBRA-SLAP	←	←	←	←	←	←	←	←				
B3	59	RIDE CYMBAL 2	←	←	←	←	←	←	←	←				
C4	60	HIGH BONGO	←	←	←	←	←	←	←	←				
C4	61	LOW BONGO	←	←	←	←	←	←	←	←				
D4	62	MUTE HIGH CONGA	←	←	←	←	←	←	←	←				
E4	63	OPEN HIGH CONGA	←	←	←	←	←	←	←	←				
F4	64	LOW CONGA	←	←	←	←	←	←	←	←				
F4	65	HIGH TIMBALE	←	←	←	←	←	←	←	←				
G4	67	LOW TIMBALE	←	←	←	←	←	←	←	←				
A4	68	HIGH AGOGO	←	←	←	←	←	←	←	←				
A4	69	LOW AGOGO	←	←	←	←	←	←	←	←				
B4	70	CABASA	←	←	←	←	←	←	←	←				
B4	71	MARACAS	←	←	←	←	←	←	←	←				
C5	72	SHORT HI WHISTLE	←	←	←	←	←	←	←	←				
C5	73	LONG LOW WHISTLE	←	←	←	←	←	←	←	←				
D5	74	SHORT GUIRO	←	←	←	←	←	←	←	←				
D5	75	LONG GUIRO	←	←	←	←	←	←	←	←				
E5	76	CLAVES	←	←	←	←	←	←	←	←				
E5	77	HIGH WOOD BLOCK	←	←	←	←	←	←	←	←				
F5	78	LOW WOOD BLOCK	←	←	←	←	←	←	←	←				
G6	79	MUTE CUICA	←	←	←	←	←	←	←	←				
G6	79	OPEN CUICA	←	←	←	←	←	←	←	←				
A5	80	MUTE TRIANGLE	←	←	←	←	←	←	←	←				
A5	81	OPEN TRIANGLE	←	←	←	←	←	←	←	←				
B5	82	SHAKER	←	←	←	←	←	←	←	←				
B5	83	JINGLE BELL	←	←	←	←	←	←	←	←				
C6	84	BELL TREE	←	←	←	←	←	←	←	←				
D6	86	CASIANETS	←	←	←	←	←	←	←	←				
D6	86	MUTE SURDO	←	←	←	←	←	←	←	←				
E6	87	OPEN SURDO	←	←	←	←	←	←	←	←				
E6	88	APPLAUSE	←	←	←	←	←	←	←	←				

Fingered Chord Chart

This table shows the fingerings for commonly used chords, including inverted fingerings.

Cuadro de acordes Fingered

Esta tabla muestra las digitaciones para los acordes usados comúnmente, incluyendo las digitaciones invertidas.

Chord Type Tipo de acorde Raíz Nota fundamental	M	m	7	m7	dim7	M7	m7 ⁵	dim	aug	sus4	7sus4	m add9	mM7	7 ⁵	add9
C															
C [♯] (D [♭])															
D															
(D [♯])/E [♭]															
E															
F															
F [♯] (G [♭])															
G															
(G [♯])/A [♭]															
A															
(A [♯])/B [♭]															
B															

※ : You can change the keyboard range of dim7 chords for roots A, B[♭], and B, and aug chords for roots B[♭] and B by adjusting the split point setting (page E-59).

※ : Puede cambiar la gama del teclado de los acordes dim7 para las notas fundamentales A, B[♭] y acordes aumentados (augment) para las notas fundamentales B[♭] y B mediante el ajuste del punto de división (página S-59).

Effect List Lista de efectos

A-10

REVERB Effect List

Lista de efectos de reverberación (REVERB)

No.	Display Name Nombre de display	Type Name Nombre de tipo
00	Room 1	Room 1
01	Room 2	Room 2
02	Room 3	Room 3
03	Hall 1	Hall 1
04	Hall 2	Hall 2
05	Plate 1	Plate 1
06	Delay	Delay
07	PanDelay	Pan Delay
08	Plate 2	Plate 2
09	Plate 3	Plate 3
10	LrgRoom 1	Large Room 1
11	LrgRoom 2	Large Room 2
12	Stadium 1	Stadium 1
13	Stadium 2	Stadium 2
14	LongDly 1	Long Delay 1
15	LongDly 2	Long Delay 2

CHORUS Effect List

Lista de efectos de chorus (CHORUS)

No.	Display Name Nombre de display	Type Name Nombre de tipo
00	Chorus 1	Chorus 1
01	Chorus 2	Chorus 2
02	Chorus 3	Chorus 3
03	Chorus 4	Chorus 4
04	FBChorus	Feedback Chorus
05	Flanger1	Flanger 1
06	SDelay 1	Short Delay 1
07	SDelay 2	Short Delay 2
08	SFChorus	Soft Chorus
09	BRChorus	Bright Chorus
10	DPChorus	Deep Chorus
11	Flanger 2	Flanger 2
12	Flanger 3	Flanger 3
13	Flanger 4	Flanger 4
14	SDelay 3	Short Delay 3
15	SDelay 4	Short Delay 4

DSP Effect List

Settable parameters depend on the DSP type. Also, the parameters for each DSP type depend on the algorithm* associated with the DSP type. See the DSP Algorithm List on page A-12 for more information.

* Effector structure and operation type

Lista de efectos DSP

Los parámetros que pueden ajustarse dependen en el tipo DSP. También, los parámetros para cada tipo DSP depende en el algoritmo* asociado con el tipo DSP. Para mayor información vea la "Lista de algoritmos DSP" en la página A-12.

* Estructura de generador de efectos y tipo de operación.

DSP No.	Algorithm ID	Display Name	DSP Name
Nº DSP	Identificación (ID) de algoritmo	Nombre de presentación	Nombre DSP
Dynamics Fx			
[00]	03	Equalize	Equalizer
[01]	06	Comp 1	Compressor 1
[02]	06	Comp 2	Compressor 2
[03]	07	Limiter	Limiter
[04]	13	Enhancer	Enhancer
Phaser			
[05]	10	Phaser	Phaser
[06]	09	StPhaser	Stereo Phaser
Chorus			
[07]	16	Chorus 1	Chorus 1
[08]	17	Chorus 2	Chorus 2
[09]	19	Chorus 3	Chorus 3
[10]	18	Chorus 4	Chorus 4
[11]	M05	Enha Cho	Enhancer - Chorus

DSP No.	Algorithm ID	Display Name	DSP Name
Nº DSP	Identificación (ID) de algoritmo	Nombre de presentación	Nombre DSP
Flanger			
[12]	26	Flanger	Flanger
[13]	M07	EnhaFlan	Enhancer - Flanger
Delay			
[14]	28	Delay	Delay
[15]	22	3Tap Dly	3-Tap Delay
[16]	20	St Delay	Stereo Delay
[17]	21	StXDelay	Stereo Cross Delay
[18]	M06	Enha Dly	Enhancer - Delay
[19]	25	Reflect	Reflection
Cho/Flanger/Delay Combination			
[20]	M02	PhaCho 1	Phaser - Chorus 1
[21]	M02	PhaCho 2	Phaser - Chorus 2
[22]	M04	PhaDly 1	Phaser - Delay 1
[23]	M04	PhaDly 2	Phaser - Delay 2
[24]	M00	ChoDly 1	Chorus - Delay 1
[25]	M00	ChoDly 2	Chorus - Delay 2
[26]	M01	ChoDly 3	Chorus - Delay 3
[27]	M01	ChoDly 4	Chorus - Delay 4
[28]	M19	CmpEnDly	Compressor - Delay
[29]	M18	CmpChoRf	Compressor - Enhancer - Delay
[30]	M23	CmpChoRf	Compressor - Chorus - Reflection
[31]	M08	Cho Flan	Chorus - Flanger
[32]	M03	FianDly 1	Flanger - Delay 1
[33]	M03	FianDly 2	Flanger - Delay 2
Reverb			
[34]	27	RvbRoom1	Reverb Room 1
[35]	27	RvbRoom2	Reverb Room 2
[36]	27	RvbRoom3	Reverb Room 3
[37]	27	RvbHall 1	Reverb Hall 1
[38]	27	RvbHall 2	Reverb Hall 2
[39]	27	RvbPlate	Reverb Plate

DSP No.	Algorithm ID	Display Name	DSP Name
Nº DSP	Identificación (ID) de algoritmo	Nombre de presentación	Nombre DSP
[40]	23	GateRvb 1	Gate Reverb 1
[41]	23	GateRvb 2	Gate Reverb 2
[42]	24	GateRvb 3	Gate Reverb 3
[43]	24	GateRvb 4	Gate Reverb 4
Pan/Tremolo Fx			
[44]	01	Tremolo	Tremolo
[45]	M09	Cho Trem	Chorus - Tremolo
[46]	00	Auto Pan	Auto Pan
[47]	M10	PhaAPan 1	Phaser - Auto Pan 1
[48]	M10	PhaAPan 2	Phaser - Auto Pan 2
[49]	M20	PhaChoAP	Phaser - Chorus - Auto Pan
Rotary Fx			
[50]	11	Rotary 1	Rotary 1
[51]	11	Rotary 2	Rotary 2
[52]	12	Od Rot 1	Overdrive - Rotary 1
[53]	12	Od Rot 2	Overdrive - Rotary 2
[54]	M17	RotRef 1	Rotary - Reflection 1
[55]	M17	RotRef 2	Rotary - Reflection 2
[56]	M17	RotRef 3	Rotary - Reflection 3
[57]	M16	OdRtRef 1	Overdrive - Rotary - Reflection 1
[58]	M16	OdRtRef 2	Overdrive - Rotary - Reflection 2
[59]	M16	OdRtRef 3	Overdrive - Rotary - Reflection 3
Wah Fx			
[60]	04	LFO Wah	LFO Wah
[61]	05	Auto Wah	Auto Wah
[62]	M21	AWhChDly	Auto Wah - Chorus - Delay
[63]	M22	LWChDly	LFO Wah - Chorus - Delay
Guitar Fx			
[64]	08	Crunch	Crunch
[65]	08	Ovrdrive	Overdrive
[66]	08	Dist 1	Distortion 1

DSP No.	Algorithm ID	Display Name	DSP Name
Nº DSP	Identificación (ID) de algoritmo	Nombre de presentación	Nombre DSP
[67]	08	Dist 2	Distortion 2
[68]	08	Metal	Metal
[69]	08	Fuzz	Fuzz
[70]	M29	CrnPhase	Crunch - Phaser
[71]	M29	Od Phase	Overdrive - Phaser
[72]	M30	Crn Cho	Crunch - Chorus
[73]	M30	OdChorus	Overdrive - Chorus
[74]	M30	Dist Cho	Distortion - Chorus
[75]	M30	MetalCho	Metal - Chorus
[76]	M31	DistFlan	Distortion - Flanger
[77]	M31	Met Flan	Metal - Flanger
[78]	M28	CrnDelay	Crunch - Delay
[79]	M28	Od Delay	Overdrive - Delay
[80]	M28	DistDly 1	Distortion - Delay 1
[81]	M28	DistDly 2	Distortion - Delay 2
[82]	M28	MetalDly	Metal - Delay
[83]	M28	Fuzz Dly	Fuzz - Delay
[84]	M24	CrChoDly	Crunch - Chorus - Delay
[85]	M24	DsChoDly	Distortion - Chorus - Delay
[86]	M25	CmpCrDly	Compressor - Crunch - Delay
[87]	M26	AWhCrDly	Auto Wah - Crunch - Delay
[88]	M26	AWhOdDly	Auto Wah - Overdrive - Delay
[89]	M26	AWhDsDly	Auto Wah - Distortion - Delay
[90]	M27	LWWhOdDly	LFO Wah - Overdrive - Delay
[91]	M27	LWWhDsDly	LFO Wah - Distortion - Delay
SFX			
[92]	14	Ring Mod	Ring Modulator
[93]	M12	RgChoDly	Ring Modulator - Chorus - Delay
[94]	M13	RingDist	Ring Modulator - Distortion
[95]	15	Lo-Fi	Lo-Fi
[96]	M11	CompLoFi	Compressor - Lo-Fi
[97]	M14	LoFi Ref	Lo-Fi - Reflection
[98]	M15	Crn LoFi	Crunch - Lo-Fi
[99]	M15	DistLoFi	Distortion - Lo-Fi

DSP Algorithm List

00 : Auto Pan

■ Function

Continually performs left-right panning of the input signal in accordance with an LFO.

■ Parameters

- 0 : Rate (Range: 0 to 127)
Adjusts the panning rate.
- 1 : Depth (Range: 0 to 127)
Adjusts the panning depth.

01 : Tremolo

■ Function

Adjusts volume of input signal in accordance with an LFO.

■ Parameters

- 0 : Rate (Range: 0 to 127)
Adjusts the tremolo rate.
- 1 : Depth (Range: 0 to 127)
Adjusts the tremolo depth.

02 : 2BandEQ

■ Function

This is a two-band equalizer.

■ Parameters

- 0 : Low Frequency (Range: 0 (200Hz), 1 (400Hz), 2 (800Hz))
Adjusts the cutoff frequency of the low-band equalizer.
- 1 : Low Gain (Range: -12, -11, -10 to 0 to +10, +11, +12)
Adjusts the gain of the low-band equalizer.
- 2 : High Frequency (Range: 0 (6.0KHz), 1 (8.0KHz), 2 (10KHz))
Adjusts the cutoff frequency of the high-band equalizer.

- 3 : High Gain (Range: -12, -11, -10 to 0 to +10, +11, +12)
Adjusts the gain of the high-band equalizer.

03 : 3BandEQ

■ Function

This is a three-band equalizer.

■ Parameters

- 0 : Low Frequency (Range: 0 (200Hz), 1 (400Hz), 2 (800Hz))
Adjusts the cutoff frequency of the low-band equalizer.
- 1 : Low Gain (Range: -12, -11, -10 to 0 to +10, +11, +12)
Adjusts the gain of the low-band equalizer.
- 2 : Mid Frequency (Range: 0 (1.0KHz), 1 (1.3KHz), 2 (1.6KHz), 3 (2.0KHz), 4 (3.0KHz), 5 (4.0KHz), 6 (6.0KHz), 7 (8.0KHz))
Adjusts the center frequency of the mid-band equalizer.
- 3 : Mid Gain (Range: -12, -11, -10 to 0 to +10, +11, +12)
Adjusts the gain of the mid-band equalizer.
- 4 : High Frequency (Range: 0 (6.0KHz), 1 (8.0KHz), 2 (10KHz))
Adjusts the cutoff frequency of the high-band equalizer.
- 5 : High Gain (Range: -12, -11, -10 to 0 to +10, +11, +12)
Adjusts the gain of the high-band equalizer.

04 : LFO Wah

■ Function

This is a “wah” effect that can automatically affect the frequency in accordance with an LFO.

■ Parameters

- 0 : Input Level (Range: 0 to 127)
Adjusts the input level. The input signal can become distorted when the level of the sound being input, the number of chords, or the Resonance value is large. Adjust this parameter to eliminate such distortion.
- 1 : Resonance (Range: 0 to 127)
Adjusts the resonance of the sound.
- 2 : Manual (Range: 0 to 127)
Adjusts the frequency used as the basis for the wah filter.
- 3 : LFO Rate (Range: 0 to 127)
Adjusts the rate of the LFO.
- 4 : LFO Depth (Range: 0 to 127)
Adjusts the depth of the LFO.

05 : Auto Wah

■ Function

This is a “wah” effect that can automatically affect the frequency in accordance with the level of the input signal.

■ Parameters

- 0 : Input Level (Range: 0 to 127)
Adjusts the input level. The input signal can become distorted when the level of the sound being input, the number of chords, or the Resonance value is large. Adjust this parameter to eliminate such distortion.
- 1 : Resonance (Range: 0 to 127)
Adjusts the resonance of the sound.
- 2 : Manual (Range: 0 to 127)
Adjusts the frequency used as the basis for the wah filter.

3 : Depth(Range: -64 to 0 to +63)

Adjusts the depth of the wah in accordance with the level of the input signal.

Setting a positive value causes the wah filter to open in direct proportion with the size of the input signal, producing a bright sound. Setting a negative value causes the Wah filter to close in accordance with the size of the input signal, which produces a dark tone quality. However, large input re-opens the Wah filter, even if it is closed.

06 : Compressor

■ Function

Compresses the input signal, which can have the effect of suppressing level variation and making it possible to sustain dampened sounds longer.

■ Parameters

0 : Depth (Range: 0 to 127)

Adjusts compression of the audio signal.

1 : Attack (Range: 0 to 127)

Adjusts the attack amount of the input signal. A smaller value causes prompt compressor operation, which suppresses the attack of the input signal.

A larger value delays compressor operation, which causes attack to be output as-is.

2 : Release (Range: 0 to 127)

Adjusts the time from the point when the input signal drops below a certain level until the compression operation is stopped.

When an attack feeling is desired (no compression at the onset of the sound), set this parameter to as low a value as possible.

To have compression applied at all times, set a high value.

3 : Level (Range: 0 to 127)

Adjusts the output level.

The output volume changes in accordance with the Depth setting and the characteristics of the input tone. Use this parameter to correct for such changes.

07 : Limiter

■ Function

This is an effector that you can use to set an upper limit value on the level of the input signal.

■ Parameters

0 : Limit (Range: 0 to 127)

Adjusts the volume level from which the limit is applied.

1 : Attack (Range: 0 to 127)

Adjusts the attack amount of the input signal.

2 : Release (Range: 0 to 127)

Adjusts the time from when the input signal drops below a certain level until the limitation stops.

3 : Level (Range: 0 to 127)

Adjusts the level being output.

The output volume changes in accordance with the Limit setting and the characteristics of the input tone. Use this parameter to correct for such changes.

08 : Distortion

■ Function

This effect provides Distortion + AmpSimulator.

■ Parameters

0 : Gain (Range: 0 to 127)

Adjusts the input gain.

1 : Low (Range: 0 to 127)

Adjusts the low-band gain.

The cutoff frequency differs according to the preset DSP.

2 : High (Range: 0 to 127)

Adjusts the high-band gain.

The cutoff frequency differs according to the preset DSP.

3 : Level (Range: 0 to 127)

Adjusts the output level.

09 : Stereo Phaser

■ Function

This is a stereo phaser that modulates the phase in accordance with a sine wave LFO.

■ Parameters

0 : Resonance (Range: 0 to 127)

Adjusts the resonance of the sound.

1 : Manual (Range: -64 to 0 to +63)

Adjusts the phaser shift volume, which is used for reference.

2 : Rate (Range: 0 to 127)

Adjusts the rate of the LFO.

3 : Depth (Range: 0 to 127)

Adjusts the depth of the LFO.

4 : Wet Level (Range: 0 to 127)

Adjusts the volume level of the effect.

10 : Phaser

■ Function

This is a monaural phaser that modulates the phase in accordance with a sine wave LFO.

■ Parameters

0 : Resonance (Range: 0 to 127)

Adjusts the resonance of the sound.

1 : Manual (Range: -64 to 0 to +63)

Adjusts the phaser shift volume, which is used for reference.

- 2 : Rate (Range: 0 to 127)
Adjusts the rate of the LFO.
- 3 : Depth (Range: 0 to 127)
Adjusts the depth of the LFO.
- 4 : Wet Level (Range: 0 to 127)
Adjusts the level of the effect sound.

11 : Rotary

■ Function
This is a rotary speaker simulator.

■ Parameters
0 : Speed (Range: Slow, Fast)
Switches the speed mode between fast and slow.

- 1 : Break (Range: Rotate, Stop)
Stops speaker rotation.
- 2 : Fall Accel (Range: 0 to 127)
Adjusts acceleration when the speed mode is switched from fast to slow.
- 3 : Rise Accel (Range: 0 to 127)
Adjusts acceleration when the speed mode is switched from slow to fast.
- 4 : Slow Rate (Range: 0 to 127)
Adjusts speaker rotation speed of the slow speed mode.
- 5 : Fast Rate (Range: 0 to 127)
Adjusts speaker rotation speed of the fast speed mode.

12 : Drive Rotary

■ Function
This is an overdrive - rotary speaker simulator.

■ Parameters
0 : Overdrive Gain (Range: 0 to 127)
Adjusts overdrive gain.
1 : Overdrive Level (Range: 0 to 127)
Adjusts the output level of the overdrive.

- 2 : Speed (Range: Slow, Fast)
Switches the speed mode between fast and slow.
- 3 : Break (Range: Rotate, Stop)
Stops speaker rotation.
- 4 : Fall Accel (Range: 0 to 127)
Adjusts acceleration when the speed mode is switched from fast to slow.
- 5 : Rise Accel (Range: 0 to 127)
Adjusts acceleration when the speed mode is switched from slow to fast.
- 6 : Slow Rate (Range: 0 to 127)
Adjusts speaker rotation speed of the slow speed mode.
- 7 : Fast Rate (Range: 0 to 127)
Adjusts speaker rotation speed of the fast speed mode.

13 : Enhancer

■ Function
Enhances the outlines of the low range and high range of the input signal.

■ Parameters
0 : Low Frequency (Range: 0 to 127)
Adjusts the low range enhancer frequency.
1 : Low Gain (Range: 0 to 127)
Adjusts the low range enhancer gain.
2 : High Frequency (Range: 0 to 127)
Adjusts the high range enhancer frequency.
3 : High Gain (Range: 0 to 127)
Adjusts the high range enhancer gain.

14 : Ring Modulator

■ Function
This is a ring modulator (AM modulator) that makes it possible to modulate the frequency of internal oscillator (OSC) in accordance with an internal LFO.

- Parameters
0 : OSC Frequency (Range: 0 to 127)
Sets the reference frequency of the internal OSC.
- 1 : LFO Rate (Range: 0 to 127)
Adjusts the rate of the LFO.
- 2 : LFO Depth (Range: 0 to 127)
Adjusts the depth of the LFO.
- 3 : Wet Level (Range: 0 to 127)
Adjusts the level of the effect sound.
- 4 : Dry Level (Range: 0 to 127)
Adjusts the level of the original sound.

15 : Lo-Fi

■ Function
This is an effector that reproduces a retro-type Lo-Fi sound using Noise Generator 1 (phonograph record player type scratch noise generator) and Noise Generator 2 (FM radio type white noise and pink noise continuous noise generator), and by noise modulation (amplitude modulation = AM) and distortion of frequency characteristics.

■ Parameters
0 : Noise Level 1 (Range: 0 to 127)
Adjusts the level of Noise Generator 1.
1 : Noise Density 1 (Range: 0 to 127)
Adjusts the noise density of Noise Generator 1.
2 : Noise Level 2 (Range: 0 to 127)
Adjusts the level of Noise Generator 2.
3 : Noise Density 2 (Range: 0 to 127)
Adjusts the noise density of Noise Generator 2.
4 : Tone (Range: 0 to 127)
Adjusts the tone.
5 : Resonance (Range: 0 to 127)
Adjusts the resonance of the sound.

- 6 : Bass(Range: -64 to 0 to +63)
Adjusts the volume of low sounds.
- 7 : Level (Range: 0 to 127)
Adjusts the output level.

16 : 1-Phase Chorus

- **Function**
This is monaural chorus in accordance with a sine wave LFO.
- **Parameters**
 - 0 : LFO Rate (Range: 0 to 127)
Adjusts the rate of the LFO.
 - 1 : LFO Depth (Range: 0 to 127)
Adjusts the depth of the LFO.
 - 2 : Feedback (Range: -64 to 0 to +63)
Adjusts the feedback of the sound.
 - 3 : Wet Level (Range: 0 to 127)
Adjusts the level of the effect sound.

17 : Sin 2-Phase Chorus

- **Function**
This is stereo chorus in accordance with a sine wave LFO.
- **Parameters**
 - 0 : LFO Rate (Range: 0 to 127)
Adjusts the rate of the LFO.
 - 1 : LFO Depth (Range: 0 to 127)
Adjusts the depth of the LFO.
 - 2 : Feedback (Range: -64 to 0 to +63)
Adjusts the feedback of the sound.
 - 3 : Wet Level (Range: 0 to 127)
Adjusts the level of the effect sound.

18 : 3-Phase Chorus

- **Function**
This is 3-phase chorus in accordance with two LFOs of with different sine wave rates.

■ Parameters

- 0 : Rate1 (Fast LFO Rate) (Range: 0 to 127)
Adjusts the rate of LFO1.
- 1 : Depth1 (Fast LFO Depth) (Range: 0 to 127)
Adjusts the depth of LFO1.
- 2 : Rate2 (Slow LFO Rate) (Range: 0 to 127)
Adjusts the rate of LFO2.
- 3 : Depth2 (Slow LFO Depth) (Range: 0 to 127)
Adjusts the depth of LFO2.
- 4 : Wet Level (Range: 0 to 127)
Adjusts the level of the effect sound.

19 : Tri 2-Phase Chorus

- **Function**
This is stereo chorus in accordance with triangular wave LFO.
- **Parameters**
 - 0 : LFO Rate (Range: 0 to 127)
Adjusts the rate of the LFO.
 - 1 : LFO Depth (Range: 0 to 127)
Adjusts the depth of the LFO.
 - 2 : Feedback(Range: -64 to 0 to +63)
Adjusts the feedback of the sound.
 - 3 : Wet Level (Range: 0 to 127)
Adjusts the level of the effect sound.

20 : Stereo Delay 1

- **Function**
This is delay of stereo input and output.
- **Parameters**
 - 0 : Delay Time (Range: 0 to 127)
Adjusts the delay time.
 - 1 : Wet Level (Range: 0 to 127)
Adjusts the level of the effect sound.
 - 2 : Feedback (Range: 0 to 127)
Adjusts the repeat of the delay.

- 3 : High Damp (Range: 0 to 127)
Adjusts damping of the high-range delay sound.
- The smaller the value, the greater the damping of high-range delay sound.
- 4 : Ratio L (Range: 0 to 127)
Adjusts the delay time of the left channel.
- Proportional to the value set for Delay Time.
- 5 : Ratio R (Range: 0 to 127)
Adjusts the delay time of the right channel.
- Proportional to the value set for Delay Time.

21 : Stereo Delay 2

- **Function**
This is cross feedback delay of stereo input and output.
- **Parameters**
 - 0 : Delay Time (Range: 0 to 127)
Adjusts the delay time.
 - 1 : Wet Level (Range: 0 to 127)
Adjusts the level of the effect sound.
 - 2 : Feedback (Range: 0 to 127)
Adjusts the repeat of the delay.
 - 3 : High Damp (Range: 0 to 127)
Adjusts damping of the high-range delay sound.
 - The smaller the value, the greater the damping of high-range delay sound.
 - 4 : Ratio L (Range: 0 to 127)
Adjusts the delay time of the left channel.
 - Proportional to the value set for Delay Time.
 - 5 : Ratio R (Range: 0 to 127)
Adjusts the delay time of the right channel.
 - Proportional to the value set for Delay Time.

22 : 3-Tap Delay

- **Function**
This is left/center/right 3-tap delay.

- Parameters
 - 0 : Delay Time (Range: 0 to 127)
Adjusts the delay time.
 - 1 : Wet Level (Range: 0 to 127)
Adjusts the level of the effect sound.
 - 2 : Feedback (Range: 0 to 127)
Adjusts the repeat of the delay.
 - 3 : High Damp (Range: 0 to 127)
Adjusts damping of the high-range delay sound.

The smaller the value, the greater the damping of high-range delay sound.

 - 4 : Ratio L (Range: 0 to 127)
Adjusts the delay time of the left channel.
Proportional to the value set for Delay Time.
 - 5 : Ratio C (Range: 0 to 127)
Adjusts the delay time of the center channel.
Proportional to the value set for Delay Time.
 - 6 : Ratio R (Range: 0 to 127)
Adjusts the delay time of the right channel.
Proportional to the value set for Delay Time.

23 : Gate Reverb

- Function
This is a fader that creates artificial reverb that sounds like it is being cut with a gate.
- Parameters
 - 0 : LPF (Range: 0 to 127)
Adjusts the cutoff frequency of the low-pass filter.
 - 1 : HPF (Range: 0 to 127)
A smaller value cuts the high range.
Adjusts the cutoff frequency of the high-pass filter.
 - 2 : Feedback (Range: 0 to 127)
Adjusts the repeat of the reverb.

- 3 : High Damp (Range: 0 to 127)
Adjusts damping of the high-range delay sound.
- The smaller the value, the greater the damping of high-range delay sound.
- 4 : Diffusion (Range: 0 to 127)
Provides fine adjustment of the reverb.
 - 5 : Wet Level (Range: 0 to 127)
Adjusts the level of the effect sound.
 - 6 : Dry Level (Range: 0 to 127)
Adjusts the level of the original sound.

24 : Reverse Gate Reverb

- Function
This is gate reverb with a reverse rotation effect.
 - Parameters
 - 0 : LPF (Range: 0 to 127)
Adjusts the cutoff frequency of the low-pass filter.
- A smaller value cuts the high range.

- 1 : HPF (Range: 0 to 127)
Adjusts the cutoff frequency of the high-pass filter.
 - A larger value cuts the low range.
 - 2 : Feedback (Range: 0 to 127)
Adjusts the repeat of the reverb.
 - 3 : High Damp (Range: 0 to 127)
Adjusts damping of the high-range reverb sound.
- The smaller the value, the greater the damping of high-range reverb sound.
- 4 : Diffusion (Range: 0 to 127)
Provides fine adjustment of the reverb.
 - 5 : Wet Level (Range: 0 to 127)
Adjusts the level of the effect sound.
 - 6 : Dry Level (Range: 0 to 127)
Adjusts the level of the original sound.

25 : Reflection

- Function
This is an effector that extracts the first reflected sound from a reverb sound.
- Parameters
 - 0 : Type (Range: 0 to 7)
Selects from among the eight available reflection patterns.
 - 1 : Wet Level (Range: 0 to 127)
Adjusts the level of the effect sound.
 - 2 : Feedback (Range: 0 to 127)
Adjusts the repeat of the reflected sound.
 - 3 : Tone (Range: 0 to 127)
Adjusts the tone of the reflected sound.

26 : Flanger

- Function
This is a flanger in accordance with a sine wave LFO.
- Parameters
 - 0 : LFO Rate (Range: 0 to 127)
Adjusts the rate of the LFO.
 - 1 : LFO Depth (Range: 0 to 127)
Adjusts the depth of the LFO.
 - 2 : Feedback (Range: -64 to 0 to +63)
Adjusts the feedback of the sound.
 - 3 : Wet Level (Range: 0 to 127)
Adjusts the level of the effect sound.

27 : Reverb

- Function
This is an effector that preserves the breadth of a sound by adding a reverb sound.
- Parameters
 - 0 : Tone (Range: 0 to 127)
Adjusts the tone of the reverb sound.

- 1 : Time (Range: 0 to 127)
Adjusts the reverb time.
- 2 : High Damp (Range: 0 to 127)
Adjusts damping of the high-range reverb sound.
- The smaller the value, the greater the damping of high-range reverb sound.
- 3 : ER Level (Range: 0 to 127)
Adjusts the level of the initial reflection.
- 4 : Wet Level (Range: 0 to 127)
Adjusts the level of the effect sound.

28 : 2-Tap Delay

- Function
This is left/right 2-tap delay.
- Parameters
- 0 : Delay Time (Range: 0 to 127)
Adjusts the delay time.
- 1 : Wet Level (Range: 0 to 127)
Adjusts the level of the effect sound.
- 2 : Feedback (Range: 0 to 127)
Adjusts the repeat of the delay.
- 3 : High Damp (Range: 0 to 127)
Adjusts damping of the high-range delay sound.
- The smaller the value, the greater the damping of high-range delay sound.
- 4 : Ratio L (Range: 0 to 127)
Adjusts the delay time of the left channel.
Proportional to the value set for Delay Time.
- 5 : Ratio R (Range: 0 to 127)
Adjusts the delay time of the right channel.
Proportional to the value set for Delay Time.

★ The following “Multi” algorithms are used in combination with the algorithms described above. Parameters are shared by both types of algorithms.

M00 : Multi00 (Sin 2-Phase Chorus – 2-Tap Delay)

- Function
This is a multi effector that is related to Sin 2-Phase Chorus - 2-Tap Delay.
- Parameters
- 0 : Chorus LFO Rate
- 1 : Chorus LFO Depth
- 2 : Chorus Feedback
- 3 : Chorus Wet Level
- 4 : Delay Time
- 5 : Delay Wet Level
- 6 : Delay Feedback
- 7 : Delay High Damp

M01 : Multi01 (3-Phase Chorus – 3-Tap Delay)

- Function
This is a multi effector that is related to 3-Phase Chorus - 3-Tap Delay.
- Parameters
- 0 : Chorus Rate 1
- 1 : Chorus Depth 1
- 2 : Chorus Rate 2
- 3 : Chorus Depth 2
- 4 : Chorus Wet Level
- 5 : Delay Time
- 6 : Delay Wet Level
- 7 : Delay Feedback

M02 : Multi02 (Phaser – 3-Phase Chorus)

- Function
This is a multi effector that is related to Phaser - 3-Phase Chorus.
- Parameters
- 0 : Phaser Resonance
- 1 : Phaser Manual

- 2 : Phaser Rate
- 3 : Phaser Depth
- 4 : Chorus Rate 1
- 5 : Chorus Depth 1
- 6 : Chorus Rate 2
- 7 : Chorus Depth 2

M03 : Multi03 (Flanger – 2-Tap Delay)

- Function
This is a multi effector that is related to Flanger - 2-Tap Delay.
- Parameters
- 0 : Flanger LFO Rate
- 1 : Flanger LFO Depth
- 2 : Flanger Feedback
- 3 : Flanger Wet Level
- 4 : Delay Time
- 5 : Delay Wet Level
- 6 : Delay Feedback
- 7 : Delay High Damp

M04 : Multi04 (Stereo Phaser – Stereo Delay 1)

- Function
This is a multi effector that is related to Stereo Phaser - Stereo Delay 1.
- Parameters
- 0 : Phaser Resonance
- 1 : Phaser Manual
- 2 : Phaser Rate
- 3 : Phaser Depth
- 4 : Phaser Wet Level
- 5 : Delay Time
- 6 : Delay Wet Level
- 7 : Delay Feedback

M05 : Multi05 (Enhancer – 1-Phase Chorus)

- **Function**
This is a multi effector related to Enhancer - 1-Phase Chorus.
- **Parameters**
 - 0 : Enhancer Low Frequency
 - 1 : Enhancer Low Gain
 - 2 : Enhancer High Frequency
 - 3 : Enhancer High Gain
 - 4 : Chorus LFO Rate
 - 5 : Chorus LFO Depth
 - 6 : Chorus Feedback
 - 7 : Chorus Wet Level

M06 : Multi06 (Enhancer – 2-Tap Delay)

- **Function**
This is a multi effector that is related to Enhancer - 2-Tap Delay.
- **Parameters**
 - 0 : Enhancer Low Frequency
 - 1 : Enhancer Low Gain
 - 2 : Enhancer High Frequency
 - 3 : Enhancer High Gain
 - 4 : Delay Time
 - 5 : Delay Wet Level
 - 6 : Delay Feedback
 - 7 : Delay High Damp

M07 : Multi07 (Enhancer – Flanger)

- **Function**
This is a multi effector related to Enhancer - Flanger.
- **Parameters**
 - 0 : Enhancer Low Frequency
 - 1 : Enhancer Low Gain
 - 2 : Enhancer High Frequency

- 3 : Enhancer High Gain
- 4 : Flanger LFO Rate
- 5 : Flanger LFO Depth
- 6 : Flanger Feedback
- 7 : Flanger Wet Level

M08 : Multi08 (Sin 2-Phase Chorus – Flanger)

- **Function**
This is a multi effector that is related to Sin 2-Phase Chorus - Flanger.
- **Parameters**
 - 0 : Chorus LFO Rate
 - 1 : Chorus LFO Depth
 - 2 : Chorus Feedback
 - 3 : Chorus Wet Level
 - 4 : Flanger LFO Rate
 - 5 : Flanger LFO Depth
 - 6 : Flanger Feedback
 - 7 : Flanger Wet Level

M09 : Multi09 (Sin 2-Phase Chorus – Tremolo)

- **Function**
This is a multi effector that is related to Sin 2-Phase Chorus - Tremolo.
- **Parameters**
 - 0 : Chorus LFO Rate
 - 1 : Chorus LFO Depth
 - 2 : Chorus Feedback
 - 3 : Chorus Wet Level
 - 4 : Tremolo Rate
 - 5 : Tremolo Depth

M10 : Multi10 (Stereo Phaser – Auto Pan)

- **Function**
This is a multi effector that is related to Stereo Phaser - Auto Pan.

- **Parameters**
 - 0 : Phaser Resonance
 - 1 : Phaser Manual
 - 2 : Phaser Rate
 - 3 : Phaser Depth
 - 4 : Phaser Wet Level
 - 5 : Auto Pan Rate
 - 6 : Auto Pan Depth

M11 : Multi11 (Compressor – Lo-Fi)

- **Function**
This is a multi effector related to Compressor - Lo-Fi.
- **Parameters**
 - 0 : Compressor Depth
 - 1 : Compressor Attack
 - 2 : Compressor Level
 - 3 : Lo-Fi Noise 1
 - 4 : Lo-Fi Noise 2
 - 5 : Lo-Fi Tone
 - 6 : Lo-Fi Resonance
 - 7 : Lo-Fi Bass

M12 : Multi12 (Ring Modulator – Sin 2-Phase Chorus - 2-Tap Delay)

- **Function**
This is a multi effector that is related to Ring Modulator - Sin 2-Phase Chorus.
- **Parameters**
 - 0 : Ring OSC Frequency
 - 1 : Ring LFO Rate
 - 2 : Ring LFO Depth
 - 3 : Ring Wet Level
 - 4 : Ring Dry Level
 - 5 : Chorus LFO Depth
 - 6 : Delay Time
 - 7 : Delay Wet Level

M13 : Multi13 (Ring Modulator – Distortion)

■ **Function**
This is a multi effector related to Ring Modulator - Distortion.

- **Parameters**
- 0 : Ring OSC Frequency
 - 1 : Ring LFO Rate
 - 2 : Ring LFO Depth
 - 3 : Ring Wet Level
 - 4 : Ring Dry Level
 - 5 : Distortion Gain
 - 6 : Distortion Tone
 - 7 : Distortion Level

M14 : Multi14 (Lo-Fi – Reflection)

■ **Function**
This is a multi effector related to Lo-Fi - Reflection.

- **Parameters**
- 0 : Lo-Fi Noise1
 - 1 : Lo-Fi Noise2
 - 2 : Lo-Fi Tone
 - 3 : Lo-Fi Resonance
 - 4 : Reflection Type
 - 5 : Reflection Wet Level
 - 6 : Reflection Feedback
 - 7 : Reflection Tone

M15 : Multi15 (Distortion – Lo-Fi)

■ **Function**
This is a multi effector related to Distortion - Lo-Fi.

- **Parameters**
- 0 : Distortion Gain
 - 1 : Distortion Low
 - 2 : Distortion High

- 3 : Distortion Level
- 4 : Lo-Fi Noise1
- 5 : Lo-Fi Noise2
- 6 : Lo-Fi Tone
- 7 : Lo-Fi Resonance

M16 : Multi16 (Drive Rotary – Reflection)

■ **Function**
This is a multi effector related to Drive Rotary - Reflection.

- **Parameters**
- 0 : Drive Rotary Gain
 - 1 : Drive Rotary Level
 - 2 : Drive Rotary Speed
 - 3 : Drive Rotary Slow Rate
 - 4 : Drive Rotary Fast Rate
 - 5 : Reflection Wet Level
 - 6 : Reflection Feedback
 - 7 : Reflection Tone

M17 : Multi17 (Rotary – Reflection)

■ **Function**
This is a multi effector related to Rotary - Reflection.

- **Parameters**
- 0 : Rotary Speed
 - 1 : Rotary Break
 - 2 : Rotary Slow Rate
 - 3 : Rotary Fast Rate
 - 4 : Reflection Wet Level
 - 5 : Reflection Feedback
 - 6 : Reflection Tone

M18 : Multi18 (Compressor – Enhancer - 2-Tap Delay)

■ **Function**
This is a multi effector that is related to Compressor - Enhancer - 2-Tap Delay.

- **Parameters**
- 0 : Compressor Depth
 - 1 : Compressor Attack
 - 2 : Compressor Level
 - 3 : Enhancer Low Gain
 - 4 : Enhancer High Gain
 - 5 : Delay Time
 - 6 : Delay Wet Level
 - 7 : Delay Feedback

M19 : Multi19 (Compressor – Stereo Delay 1)

■ **Function**
This is a multi effector related to Compressor - Stereo Delay 1.

- **Parameters**
- 0 : Compressor Depth
 - 1 : Compressor Attack
 - 2 : Compressor Release
 - 3 : Compressor Level
 - 4 : Delay Time
 - 5 : Delay Wet Level
 - 6 : Delay Feedback
 - 7 : Delay High Damp

M20 : Multi20 (Phaser – 1-Phase Chorus – Auto Pan)

■ **Function**
This is a multi effector that is related to Phaser - 1-Phase Chorus - Auto Pan.

- **Parameters**
- 0 : Phaser Resonance

- 1 : Phaser Manual
- 2 : Phaser Rate
- 3 : Phaser Depth
- 4 : Chorus LFO Rate
- 5 : Chorus LFO Depth
- 6 : Auto Pan Rate
- 7 : Auto Pan Depth

M21 : Multi21 (Auto Wah – Tri 2-Phase Chorus – 2-Tap Delay)

■ **Function**
This is a multi effector that is related to Auto Wah - Tri 2-Phase Chorus - 2-Tap Delay.

- **Parameters**
- 0 : Wah Resonance
 - 1 : Wah Manual
 - 2 : Wah Depth
 - 3 : Chorus LFO Rate
 - 4 : Chorus LFO Depth
 - 5 : Delay Time
 - 6 : Delay Wet Level
 - 7 : Delay Feedback

M22 : Multi22 (LFO Wah – Tri 2-Phase Chorus – 2-Tap Delay)

■ **Function**
This is a multi effector that is related to LFO Wah - Tri 2-Phase Chorus - 2-Tap Delay.

- **Parameters**
- 0 : Wah Resonance
 - 1 : Wah Manual
 - 2 : Wah LFO Rate
 - 3 : Wah LFO Depth
 - 4 : Chorus LFO Depth
 - 5 : Delay Time
 - 6 : Delay Wet Level
 - 7 : Delay Feedback

M23 : Multi23 (Compressor – Sin 2-Phase Chorus – Reflection)

■ **Function**
This is a multi effector that is related to Compressor - Sin 2-Phase Chorus - Reflection.

- **Parameters**
- 0 : Compressor Depth
 - 1 : Compressor Attack
 - 2 : Compressor Level
 - 3 : Chorus LFO Rate
 - 4 : Chorus LFO Depth
 - 5 : Reflection Wet Level
 - 6 : Reflection Feedback
 - 7 : Reflection Tone

M24 : Multi24 (Distortion – 1-Phase Chorus – 2-Tap Delay)

■ **Function**
This is a multi effector that is related to Distortion - 1-Phase Chorus - 2-Tap Delay.

- **Parameters**
- 0 : Distortion Gain
 - 1 : Distortion Low
 - 2 : Distortion High
 - 3 : Distortion Level
 - 4 : Chorus LFO Depth
 - 5 : Delay Time
 - 6 : Delay Wet Level
 - 7 : Delay Feedback

M25 : Multi25 (Compressor – Distortion – 2-Tap Delay)

■ **Function**
This is a multi effector that is related to Compressor - Distortion - 2-Tap Delay.

- **Parameters**
- 0 : Compressor Depth

- 1 : Distortion Gain
- 2 : Distortion Low
- 3 : Distortion High
- 4 : Distortion Level
- 5 : Delay Time
- 6 : Delay Wet Level
- 7 : Delay Feedback

M26 : Multi26 (Auto Wah – Distortion – 2-Tap Delay)

■ **Function**
This is a multi effector that is related to Auto Wah - Distortion - 2-Tap Delay.

- **Parameters**
- 0 : Wah Manual
 - 1 : Wah Depth
 - 2 : Distortion Gain
 - 3 : Distortion Tone
 - 4 : Distortion Level
 - 5 : Delay Time
 - 6 : Delay Wet Level
 - 7 : Delay Feedback

M27 : Multi27 (LFO Wah – Distortion – 2-Tap Delay)

■ **Function**
This is a multi effector that is related to LFO Wah - Distortion - 2-Tap Delay.

- **Parameters**
- 0 : Wah Manual
 - 1 : Wah LFO Rate
 - 2 : Wah LFO Depth
 - 3 : Distortion Gain
 - 4 : Distortion Level
 - 5 : Delay Time
 - 6 : Delay Wet Level
 - 7 : Delay Feedback

M28 : Multi28 (Distortion – 3-Tap Delay)

■ Function

This is a multi effector that is related to Distortion - 3-Tap Delay.

■ Parameters

- 0 : Distortion Gain
- 1 : Distortion Low
- 2 : Distortion High
- 3 : Distortion Level
- 4 : Delay Time
- 5 : Delay Wet Level
- 6 : Delay Feedback
- 7 : Delay High Damp

M29 : Multi29 (Distortion – Phaser)

■ Function

This is a multi effector related to Distortion - Phaser.

■ Parameters

- 0 : Distortion Gain
- 1 : Distortion Low
- 2 : Distortion High
- 3 : Distortion Level
- 4 : Phaser Resonance
- 5 : Phaser Manual
- 6 : Phaser Rate
- 7 : Phaser Depth

M30 : Multi30 (Distortion – Sin 2-Phase Chorus)

■ Function

This is a multi effector that is related to Distortion - Sin 2-Phase Chorus.

■ Parameters

- 0 : Distortion Gain
- 1 : Distortion Low

- 2 : Distortion High
- 3 : Distortion Level
- 4 : Chorus LFO Rate
- 5 : Chorus LFO Depth
- 6 : Chorus Feedback
- 7 : Chorus Wet Level

M31 : Multi31 (Distortion – Flanger)

■ Function

This is a multi effector related to Distortion - Flanger.

■ Parameters

- 0 : Distortion Gain
- 1 : Distortion Low
- 2 : Distortion High
- 3 : Distortion Level
- 4 : Flanger LFO Rate
- 5 : Flanger LFO Depth
- 6 : Flanger Feedback
- 7 : Flanger Wet Level

Change	73	O	O	Attack Time
				Brightness
	74	O	O	Vibrato rate
	76	O	O	Vibrato depth
	77	O	O	Vibrato delay
	78	O	O	DSP Parameter4
	80	O	O	DSP Parameter5
	81	O	O	DSP Parameter6
	82	O	O	DSP Parameter7
	83	O	O	Reverb send
	91	O	O	Chorus send
	93	O	O	NRPN LSB, MSB
	98, 99	X	O	RPN LSB, MSB
	100, 101	O	O	All sound off
	120	X	O	Reset all controller
	121	O	O	
Program Change :	True #	O 0-127 *****	O 0-127 *****	
System Exclusive		O		
System Common	: Song Pos : Song Sel : Tune	X X X		
System Real Time	: Clock : Commands	X X		
Aux Messages	: Local ON/OFF : All notes OFF : Active Sense : Reset	X X X X		
Remarks	* ² Selected in accordance with sustain pedal setting. * ² Seleccionado de acuerdo con el ajuste del pedal de sustain.			

Mode 1 : OMNI ON, POLY
Mode 3 : OMNI OFF, POLY

Mode 2 : OMNI ON, MONO
Mode 4 : OMNI OFF, MONO

O : Yes
X : No

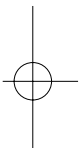



This recycle mark indicates that the packaging conforms to the environmental protection legislation in Germany.

Esta marca de reciclaje indica que el empaquetado se ajusta a la legislación de protección ambiental en Alemania.

CASIO®

CASIO COMPUTER CO.,LTD.
6-2, Hon-machi 1-chome
Shibuya-ku, Tokyo 151-8543, Japan

MA0105-B   Printed in Malaysia
CTK671-ES-1