

CONTENTS

BEFORE USING THE WASHING MACHINE

**PRECAUTIONS AND GENERAL
RECOMMENDATIONS**

**DESCRIPTION OF THE WASHING MACHINE
DOOR**

CHILD SAFETY (IF AVAILABLE)

BEFORE THE FIRST WASH CYCLE

PREPARATION OF THE WASHING

DETERGENTS AND ADDITIVES

REMOVING THE FILTER

DRAINING RESIDUAL WATER

CARE AND MAINTENANCE

TROUBLESHOOTING GUIDE

AFTER SALES SERVICE

ACCESSORIES

TRANSPORT / HANDLING

BEFORE USING THE WASHING MACHINE

1. Removing the packaging and inspection

- After unpacking, make sure that the washing machine is undamaged. If in doubt, do not use the washing machine. Contact After-Sales Service or your local retailer
- Check that the accessories and supplied parts are all present
- Keep the packaging materials (plastic bags, polystyrene parts, etc.) out of reach of children, as they are potentially dangerous

2. Remove the transport bolts

- The washing machine is fitted with transport bolts to avoid any possible damage to the interior during transport. Before using the machine, it is imperative that the transport bolts are removed

3. Install the washing machine

- Remove the protective film from the control panel
- Move the appliance without lifting it by the worktop
- Install the appliance on a solid and level floor surface, preferably in a corner of the room
- Make sure that all four feet are stable and resting on the floor and then check that the washing machine is perfectly level (use a spirit level).

4. Water inlet

- Connect the water supply inlet hose in accordance with the regulations of your local water company
- Water inlet: Cold water only
- Water tap: 3/4" threaded hose connector
- Water pressure (flow pressure): 100-1000 kPa (1-10 bar).

5. Drain

- Connect the drain hose to the siphon or hook it over the edge of a sink by means of the "U" bend supplied
- If the washing machine is connected to an integrated drainage system, ensure the latter is equipped with a vent to avoid simultaneous loading and draining of water (siphoning effect)

6. Electrical connection

- Electrical connections must be carried out by a qualified technician in compliance with the manufacturer's instructions and current standard safety regulations
- Data regarding voltage, power consumption and protection requirements is given on the inside of the door.
- The appliance must be connected to the mains by means of a socket with an earth connection in accordance with current regulations. The washing machine must be earthed by law. The manufacturer declines all liability for damage to property or injury to persons or animals due to non-compliance with the directions given above
- Do not use extension leads or multiple sockets
- Before any maintenance on the washing machine disconnect it from the mains supply
- After installation, access to the mains plug or to disconnection from mains supply must be ensured at all times via a double-pole switch
- Do not operate the washing machine if it has been damaged during transport. Inform the After-Sales Service
- Mains cable replacement is only to be carried out by After-Sales Service
- The appliance must only be used in the household for the prescribed uses

Minimum housing dimensions:

Width:	600 mm
Height:	825 mm
Depth:	600 mm

PRECAUTIONS AND GENERAL RECOMMENDATIONS

1. Packaging

- The packaging material is entirely recyclable, and marked with the recycling symbol . Adhere to current local regulations when disposing of packaging material

2. Disposing of packaging and scrapping old washing machines

- This appliance is marked according to the European directive 2002/96/EC on Waste Electrical and Electronic Equipment (WEEE). By ensuring this product is disposed of correctly, you will help prevent potential negative consequences for the environment and human health, which could otherwise be caused by inappropriate waste handling of this product.

The symbol  on the product, or on the documents accompanying the product, indicates that this appliance may not be treated as household waste. Instead it shall be handed over to the applicable collection point for the recycling of electrical and electronic equipment.

Disposal must be carried out in accordance with local environmental regulations for waste disposal.

For more detailed information about treatment, recovery and recycling of this product, please contact your local city office, your household waste disposal service or the shop where you purchased the product.

- The washing machine is built from reusable materials. It must be disposed of in compliance with current local waste disposal regulations
- Before scrapping, remove all detergent residues and cut off the power cable so that the washing machine is made unusable

3. General recommendations

- Do not leave the appliance plugged in when not in use
- Turn off the tap
- Before any cleaning and maintenance switch off the machine or disconnect it from the mains
- Clean the outside of the washing machine with a damp cloth. Do not use abrasive detergents
- Never open the door forcibly or use it as a step
- Children must not be allowed to play with the washing machine or to climb into the drum (see also the following page chapter "Child Safety")
- If necessary, the power cable may be replaced with an identical one obtained from our After-Sales Service. The power cable must only be replaced by a qualified technician

4. EC Declaration of Conformity

- The appliance conforms to the following European Standards:
Low voltage directive 73/23/EEC
89/336/EEC Electromagnetic Compatibility Directive
93/68/EC CE Marking Directive. 

DESCRIPTION OF THE WASHING MACHINE

1. Worktop
2. Control panel
3. Detergent dispenser
4. Service plate (inside the door)
5. Door
6. Child safety device (if provided, inside the door)
7. Filter (behind cover)
8. Plinth
9. Adjustable feet

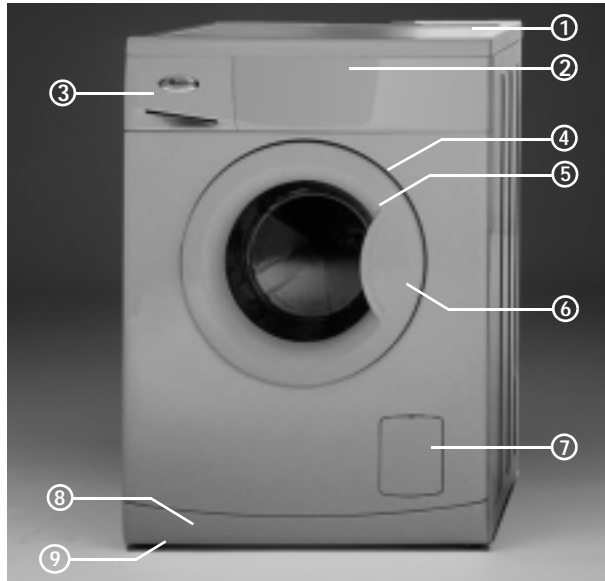

DOOR

To open the door, hold the door handle, press the inside handle and pull the door. Close the door by pressing it without excessive force until it clicks shut.

CHILD SAFETY (IF AVAILABLE)

To protect the appliance against improper use, turn the plastic screw on the interior of the door. To do this, use the thick rounded corner of the coloured insert from the detergent dispenser or a coin:

- Slot vertical: the door will not lock
- Slot horizontal - normal position: the door can be locked again



BEFORE THE FIRST WASH CYCLE

To remove any residual water used in testing by the manufacturer, we recommend that you carry out a short wash cycle without laundry.

1. Open the tap.
2. Close the door.
3. Pour a little detergent (about 30 ml) into the detergent compartment .
4. Select and start a short programme (see quick reference guide).

PREPARATION OF THE WASHING

1. Sort the laundry according to...

- **Type of fabric / care label symbol**
Cottons, mixed fibres, easy care/synthetics, wool, handwash items
- **Colour**
Separate coloured and white items. Wash new coloured articles separately
- **Loading**
Wash items of different sizes in the same load to improve washing efficiency and distribution in the drum.
- **Delicates**
Wash small items (e.g. nylon stockings, belts etc.) and items with hooks (e.g. bras) in a cloth bag or pillow case with zip. Always remove curtain rings or wash curtains with the rings inside a cotton bag

2. Empty all pockets

Coins, safety pins etc. can damage your laundry as well as the appliance drum and tub.

3. Fasteners

Close zips and fasten buttons or hooks; Loose belts or ribbons should be tied together

Stain removal

- Blood, milk, eggs etc. are generally removed by the automatic enzyme phase of the programme
- To remove red wine, coffee, tea, grass and fruit stains etc. add a stain remover to the detergent  dispenser chamber
- Pre-treat heavily-soiled areas with stain remover if necessary

Dyeing

- Only use dyes that are suitable for washing machines
- Follow the Manufacturer's instructions
- Plastic and rubber parts of the washing machine can be stained by dyes

Loading the laundry

1. Open the door.
2. Load the articles one at a time loosely into the drum, without overfilling. Observe the load sizes given in the quick reference guide.
Note: overloading the machine will result in unsatisfactory washing results and creased laundry
3. Close the door.

DETERGENTS AND ADDITIVES

The choice of detergent depends on:

- type of fabric (cottons, easy care/synthetics, delicate items, wool).
Note: Use only specific detergents for washing wool
- colour
- the wash temperature
- degree and type of soiling

Remarks:

Any whitish residues on dark fabrics are caused by insoluble compounds used in modern phosphate-free powder detergents. If this occurs, shake or brush out the fabric or use liquid detergents.

Use only detergents and additives specifically produced for domestic washing machines.

When using descaling agents, dyes or bleaches for the pre-wash, make sure that they are suitable for use in domestic washing machines. Descalers could contain products which could damage your washing machine.

Do not use any solvents (e.g. turpentine, benzine). Do not machine wash fabrics that have been treated with solvents or flammable liquids.

Dosage

Follow the dosage recommendations on the detergent pack. They depend on:

- degree and type of soiling
- size of wash
follow the detergent manufacturer's instructions for a full load;
half load: 3/4 the amount used for a full load;
Minimum load (about 1 kg):
1/2 the amount used for a full load
- water hardness in your area (ask for information from your water company). Soft water requires less detergent than hard water (refer to the water hardness table in the operating instructions).

Notes:

Too much detergent can result in excess foam formation, which reduces washing efficiency. If the washing machine detects too much foam, it may prevent spinning.

Insufficient detergent may result in grey laundry in time and also calcifies the heating system, drum and hoses.

Water Hardness Chart

Water hardness	Characteristics	German °dH	French °fH	English °eH
1	soft	0-7	0-12	0-9
2	average	7-14	12-25	9-17
3	hard	14-21	25-37	17-26
4	very hard	over 21	over 37	over 26

Where to put detergent and additives

The detergent drawer has three chambers (fig. "A").

Chamber



- Detergent for the prewash

Chamber



- Detergent for the main wash
- Stain remover
- Water softener (water hardness class 4)

When using liquid detergent, remove the coloured insert from the detergent container and insert it in the first gap in chamber (fig. "A").

The insert has a scale to make dosing easier.

Chamber



- Fabric Softener
- Liquid starch

Only pour additives in up to the "MAX" mark.

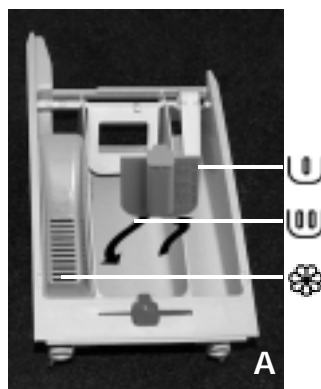

Notes:

- Keep detergents and additives in a safe, dry place out of the reach of children.
- Liquid detergents can be used for programmes with prewash. In this case, a powder detergent must be used for the main wash.
- To prevent dispensing problems when using highly concentrated powder and liquid detergents, use the special detergent ball or bag supplied with the detergent and place it directly inside the drum.
- When using descaling agents, bleaches or dyes, make sure that they are suitable for washing machines. Descalers could contain components that can attack parts of your washing machine.
- Do not use any solvents in the washing machine (e.g. turpentine, benzine).
- If you use starch powder, proceed as follows:
 1. Wash your laundry using the desired wash programme.
 2. Mix the starch to water in a beaker.
 3. Select the "Rinse and Spin" programme, reduce the speed to 800 rpm and start the programme.
 4. Pull out the detergent drawer until you can see about 3 cm of chamber (B).
 5. Pour the starch solution into chamber (C) while the water is running into the detergent drawer.
 6. If there are starch residues in the detergent drawer when the programme has finished, clean if necessary (see "Cleaning and Maintenance").Take note also of the starch manufacturer's instructions for use.

REMOVING THE FILTER

We recommend that you check and clean the filter regularly, at least two or three times a year.

Especially:

- If the appliance is not draining properly or if it fails to perform spin cycles.
- If the pump is blocked by a foreign body (e.g. buttons, coins or safety pins)

IMPORTANT: make sure the water has cooled before draining the appliance.

1. Stop the appliance and unplug it.
2. Open the filter cover. Open the filter cover with the aid of the coloured insert from the detergent container.
3. Place a container beneath it.
4. Open the filter but do not remove it completely. Slowly turn the filter anticlockwise until the water begins to drain out.
5. Wait until all the water has drained.
6. Now unscrew the filter completely and remove it.
7. Clean the filter and the filter chamber.
8. Check that the pump rotor moves freely.
9. Re-insert the filter and screw it in clockwise as far as it will go (handle must be horizontal).
10. Pour about 1 litre of water into the detergent drawer to reactivate the "Eco system". Check that the foreign body trap is inserted properly and securely.
11. Close the cover and lock it.
12. Plug in the appliance once again.
13. Select a programme and start it.



DRAINING RESIDUAL WATER

Before emptying the residual water, switch the appliance off and unplug it from the mains socket.

Open the cover of the foreign body trap. Open the filter cover with the aid of the coloured insert from the detergent container. Place a container beneath it.

1. Open the filter but do not remove it completely. Slowly turn the filter anticlockwise until the water begins to drain out.
2. Wait until all the water has drained.
3. Now unscrew the filter completely and remove it.
4. Tilt the appliance forwards carefully to allow the water to flow out.
5. Re-insert the filter and screw it in clockwise as far as it will go (handle must be horizontal).
6. Close the cover and lock it.

Before using the washing machine again:

1. Pour approx. 0.5 litre of water into the detergent drawer to reactivate the "Eco system".
2. Plug in the appliance once again.

CARE AND MAINTENANCE

Appliance exterior and control panel

- Can be washed down with a soft, damp cloth
- A little neutral detergent (non abrasive) can also be used.
- Dry with a soft cloth

Door seal

- Clean with a damp cloth when necessary
- Check the condition of the door seal periodically

Filter

- Check and clean the filter regularly, at least two or three times a year (see "Removing the filter").

Detergent dispenser

1. Press the release lever in the prewash compartment downward and remove the drawer.
2. Remove the coloured grid (fig. "A") from the fabric softener compartment.
Remove the insert from the fabric softener compartment.
3. Wash all the parts under running water.
4. Refit the insert and the grid in the detergent drawer and fit the drawer back inside its housing.

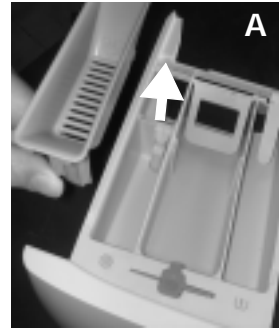

Mesh filter for water connection

Check and clean regularly.

For washing machines with a straight inlet hose

1. Close the tap and loosen the inlet hose on the tap.
2. Clean the internal mesh filter and screw the water inlet hose back onto the tap.
3. Now unscrew the inlet hose on the rear of the washing machine.
4. Pull off the mesh filter from the washing machine connection with universal pliers and clean it.
5. Refit the mesh filter and screw the inlet hose on again.
6. Turn on the tap and ensure that the connections are completely water-tight.

For machines with Water Stop hose

1. Turn off the tap and unscrew the Water Stop hose from the tap.
2. Clean the internal mesh filter and screw the water inlet hose back onto the tap.
3. Turn on the tap and make sure the connections are completely water-tight.



TROUBLESHOOTING GUIDE

Depending on the model, your washing machine is equipped with various automatic safety functions. This enables faults to be detected in good time and the safety system can react appropriately. These faults are frequently so minor that they can be removed within a few minutes.

The washing machine will not start, no indicator lamps are on.

Check whether:

- the mains plug is inserted into the socket
- the wall socket is functioning correctly (use a table lamp or similar appliance to test it)

The washing machine will not start... and the "Start/Pause" indicator lamp flashes.

Check whether:

- the door is properly closed (child safety);
- the "Start/Pause" button has been pressed. In models with LCD display, the display shows:

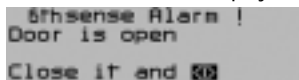

5thsense Alarm !
Door is open
Close it and 00

- the water tap is closed. For models with a "Water tap closed" indicator lamp, the red indicator lamp lights up. Open the tap and press the "Start/Pause" button.

The appliance stops during the programme (varies depending on model)

Check whether:

- the "Rinse Hold" indicator lamp is flashing; terminate this option by pressing the button again
In models with LCD display: the "Rinse Hold" option has been preselected and the "Rinse Hold" symbol appears on the display; cancel this option by pressing the "↔" button or select the "Drain" programme
- another programme has been selected and the "Start/Pause" indicator lamp is flashing. Reselect the desired programme and press the "Start/Pause" button
- the door has been opened and the "Start/Pause" indicator lamp is flashing. Close the door and press the "Start/Pause" button again. In models with LCD display, the display shows: "PAUSE!"
- the washing machine's safety system has been activated (see "Fault display chart")

Residue from detergent and additives left in the detergent drawer at end of wash.

Check whether:

- the siphon is correctly installed and clean (see "Care And Maintenance")
- sufficient water is entering.
The mesh filters of the water supply could be blocked (see "Care And Maintenance")
- When using powder detergent beforehand the coloured insert for dosing liquid detergent has been removed from the dispenser 

Machine vibrates during spin cycle.

Check whether:

- the washing machine is level and standing firmly on all four feet
- the transit bolts have been removed. Before using the machine, it is imperative that the transport bolts are removed

Final spin results are poor.

The washing machine has an imbalance detection and correction system.

If individual heavy items are loaded (e.g. bathrobes), this system may reduce the spin speed automatically or even interrupt the spin completely if it detects too great an imbalance even after several spin starts, in order to protect the washing machine.

In models with LCD display, in the event of an imbalance, the display shows:

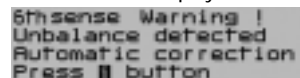

5thsense Warning !
Unbalance detected
Automatic correction
Press II button

- If the laundry is still too wet at the end of the cycle, add smaller articles of laundry and repeat the spin cycle
- Excessive foam formation may prevent spinning. Use the correct amount of detergent
In models with LCD display, the display shows:

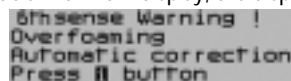

5thsense Warning !
Overfoaming
Automatic correction
Press II button

- Check that the spin speed selector has not been set to "0"

The programme time indicated on the remaining time display (if fitted) “jumps” up or down suddenly by several minutes, or the programme time shown initially is lengthened/shortened by a period of time:

This is a normal capacity of the washing machine to adapt to factors that the wash programme time can have an effect on, e.g.:





- excess foam formation
- load imbalance due to heavy items of laundry
- prolonged heating time due to reduced delivery of hot water

Because of influences like these, the time remaining in the programme run is recalculated, and updated if necessary. In addition, during the filling phase, the washing machine determines the load and if necessary adjusts the initial programme time displayed accordingly.

Fault description table

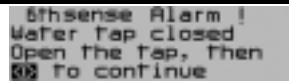
Small indicator light is on.	Digital display	Fault description
“Water tap closed”	“FH”	“Water supply fault”
“Clean pump”	“FP”	“Draining fault”
-	from “F15” to “F19”	“Electrical module fault”
“Water Stop”	“FA”	“Water Stop Fault”

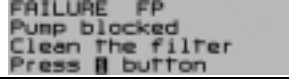
Fault description table for models with LCD display

LCD display	Start/Pause button	Fault description
	flashing	Water supply fault
	flashing	Fault in an electrical component
	flashing	Draining fault
	flashing	Water Stop Fault

a. Water supply fault

The appliance has no or insufficient water supply.

For models with fault display, the “Water tap closed” indicator lamp lights up or “FH” flashes on the display.

For models with LCD display, the display shows:

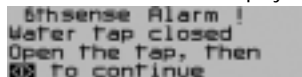

For models with no fault display, the washing machine stops in the appropriate programme step.

Stop the appliance and unplug it.

Check whether:

- the water tap is fully open and there is sufficient water supply pressure
- kinks are present in water hose
- the mesh filters of the water supply are blocked (see “Care And Maintenance/Mesh filters for water connection”)
- the water hose is frozen up
- the washing machine has a safety hose and the safety valve is open (red indicator in the safety valve inspection window); In this case replace it with a new safety hose

Plug in the appliance once again.

reselect the desired programme and press the “On/Off” button.

If the fault occurs again, please contact After-Sales Service (see “After Sales Service”).

b. Draining fault

Waste water not pumped out.

In models with LCD display, the display shows:

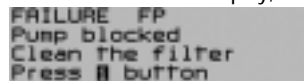

FAILURE FP
Pump blocked
Clean the filter
Press II button

For models with a fault display, depending on the model, "FP" lights up and remains lit or flashes. If a "Clean pump" indication is fitted, the red indication next to it lights up.

For models with no fault display, the washing machine stops in the appropriate programme step. Stop the appliance and unplug it.

Check whether:

- kinks are present in the drain hose;
- the pump or the filter is blocked (see "Removing the filter")

IMPORTANT: make sure the water has cooled before draining the appliance.

- the drain hose is frozen up

Plug in the appliance once again.

Select and start the "Drain/Reset" programme.

If the fault occurs again, please contact After Sales Service (see "After Sales Service").

c. Fault in an electrical component

The appliance stops during the programme.

If a digital or LCD display is fitted, "E4" to "E31" are also displayed.

Select and start the "Drain" or "Reset" programme.

Next, select and start the desired programme.

For models with no fault display, the washing machine stops in the appropriate programme step.

Switch the washing machine off and back on again to continue the programme.

If the fault persists, please contact After Sales Service (see "After Sales Service").

d. Water Stop fault (if available)

The "Water Stop" may have been triggered by:

1. excess foaming
2. a leak in the washing machine

In this case the pump is switched on automatically in order to drain the water

In models with LCD display, the display shows:



FAILURE FA
Water Stop Fault

For models with a fault display, the "Water Stop" indicator light lights up. The display shows "FA" or alternately "F" and "A" and the pump is running.

Switch off the appliance, unplug it and make sure that the water tap is closed.

Carefully tilt the appliance forwards to allow the water to flow out.

Then:

1. Plug in the appliance.
2. Turn the water tap on (if water immediately flows into the appliance again, without the appliance running, there is a fault. Shut the water tap, then call After-Sales Service).
3. Select and start the desired programme again.

AFTER SALES SERVICE

Before contacting After Sales Service:

1. Try to remedy the problem yourself (see "Troubleshooting Guide").
2. Restart the programme to check whether the problem has solved itself.
3. If the washing machine continues to function incorrectly, call After Sales Service.

Specify:

- The nature of the problem.
- The washing machine model.
- The service code (number after the word SERVICE).

SERVICE 0000 000 00000



The After Sales Service sticker can be found inside the door.

- Your full address.
- Your telephone number and area code.
After Sales Service phone numbers and addresses are given on the guarantee card. Alternatively, consult the dealer where you purchased the appliance.

ACCESSORIES

Via our After Sales Service or your specialist dealer, you can obtain

- a **Pedestal Drawer** which can be installed beneath your washing machine. It raises your machine to allow for more comfortable loading and unloading, as you now no longer need to bend as far to access the unit. Furthermore, it offers a great space-management tool and storage solution.
- a **Stacking Kit** by means of which you can fix your dryer on top of your washing machine and thus effectively save space.

Some models are able to be installed under your kitchen worktop; in that case, please contact our After Sales Service (see above). Be aware that

- the appliance **MUST** be installed under a continuous worktop
- according to the legal safety regulations, the installation of the appliance **MUST** be carried out by an authorized technician or by our After Sales Service
- the appliance **MUST** be installed using the intermediate cover panel of the **UBS Base Set** which can be obtained from specialist dealers or our After Sales Service

TRANSPORT / HANDLING

Never lift the appliance by the worktop when transporting.

1. Pull out the mains plug.
2. Turn off the tap.
3. Disconnect the inlet and drain hoses.
4. Eliminate all water from the hoses and from the appliance (see "Removing the Filter", "Draining Residual Water").
5. Fit the transit bolts (obligatory)

ELECTRICAL CONNECTION

For Great Britain only

Warning - this appliance must be earthed

Fuse replacement

If the mains lead of this appliance is fitted with a BS 1363A 13amp fused plug, to change a fuse in this type of plug use an A.S.T.A. approved fuse to BS 1362 type and proceed as follows:

1. Remove the fuse cover (A) and fuse (B).
2. Fit replacement 13A fuse into fuse cover.
3. Refit both into plug.

Important:

The fuse cover must be refitted when changing a fuse and if the fuse cover is lost the plug must not be used until a correct replacement is fitted.

Correct replacement are identified by the colour insert or the colour embossed in words on the base of the plug.

Replacement fuse covers are available from your local electrical store.

For the Republic of Ireland only

The information given in respect of Great Britain will frequently apply, but a third type of plug and socket is also used, the 2-pin, side earth type.

Socket outlet / plug (valid for both countries)

If the fitted plug is not suitable for your socket outlet, Please contact Whirlpool Service for further instruction. Please do not attempt to change plug yourself. This procedure needs to be carried out by a qualified Whirlpool technician in compliance with the manufactures instructions and current standard safety regulations.

