

<b>1</b>	<b>SAFETY .....</b>	<b>2</b>			
1.1	General hazards .....	2		5.4	Heaters .....
1.2	Electrical shock / fire hazards.....	2		5.5	2-piece drain hose connection .....
1.3	Plumbing / scalding hazards.....	2		5.6	Drain pump removal and installation .....
<b>2</b>	<b>INSTALLATION .....</b>	<b>3</b>		5.7	Door latch removal and installation .....
2.1	Pre-Install checklist .....	3		<b>6</b>	<b>FAULT DIAGNOSTICS.....</b>
2.2	Alignment .....	3		6.1	Customer service test program .....
2.3	Electrical connection .....	4		6.2	Troubleshooting.....
2.4	Water connection.....	4		<b>7</b>	<b>TECHNICAL SPECIFICATIONS .....</b>
2.5	Drain and condensation hose connections.....	5			<b>42</b>
<b>3</b>	<b>OPERATION .....</b>	<b>6</b>			
3.1	Control layout.....	6			
3.2	Reset (“Cancel – drain”).....	7			
3.3	Changing basic features (on selected units).....	7			
3.4	Entering special programs and coding.....	7			
3.5	Dispenser.....	9			
<b>4</b>	<b>COMPONENTS.....</b>	<b>10</b>			
4.1	Dishwasher components.....	10			
4.2	Operation.....	26			
4.3	Serial label (warranty information) .....	26			
<b>5</b>	<b>REPAIR.....</b>	<b>28</b>			
5.1	Water valves .....	28			
5.2	Circulation pumps.....	28			
5.3	Controls .....	31			

# 1 SAFETY

## 1.1 General hazards



Don't use the dishwasher until it is completely installed. When opening the door on an uninstalled dishwasher, carefully open the door while supporting the rear of the unit. Failure to follow this warning can cause the dishwasher to tip over and result in serious injury.

In some conditions, hydrogen gas can form in a hot water system that has not been used for weeks. Hydrogen gas is explosive. Before filling a dishwasher from a system that has been off for weeks, run the water from a nearby faucet in a well ventilated area until there is no sound or evidence of gas.

Temperatures required for soldering and sweating will damage the dishwasher's base and water inlet valve. If plumbing lines are to be soldered or sweated, keep the heat source at least 6 inches (152.4 mm) away from the dishwasher's base and water inlet valve.

Removing any cover or pulling the dishwasher from the cabinet can expose hot water connections, electrical power and sharp edges or points. Handle with care. Always wear gloves and safety glasses.

## 1.2 Electrical shock / fire hazards



Don't allow electrical and water supply lines to touch. Don't work on an energized circuit. Doing so could result in serious injury or death. Only qualified electricians should perform electrical work. Don't attempt any work on the dishwasher electric supply circuit until you are certain the circuit is de-energized.

Make sure electrical work is properly installed. There should be no loose electrical connections. Ensure all electrical connections are properly made.

The customer has the responsibility of ensuring that the dishwasher electrical installation is in compliance with all national and local electrical codes and ordinances. The dishwasher is designed for an electrical supply of 120VAC, 60 Hz, connected to a dishwasher-dedicated, properly grounded electrical circuit with a fuse or breaker rated for 15 amps. Electrical supply conductors shall be a minimum #14 AWG copper only wire rated at 75°C (167°F) or higher.

This appliance must be connected to a grounded metal, permanent wiring system, or an equipment-grounding conductor must be run with the circuit conductors and connected to the equipment-grounding terminal or lead on the appliance. Don't use extension cords.

## 1.3 Plumbing / scalding hazards



Don't perform any work on a charged hot water line. Serious injury could result. Only qualified plumbers should perform plumbing work. Don't attempt any work on the dishwasher hot water supply plumbing until you are certain the hot water supply is shut off.

Don't over tighten the 90° elbow. Doing so may damage the water inlet valve and cause a water leak. Temperatures required for soldering and sweating will damage the dishwasher's water inlet valve. If plumbing lines are to be soldered or sweated, keep the heat source at least 6 inches (152.4 mm) away from the dishwasher's water inlet valve.

Check local plumbing codes for approved plumbing procedures and accessories. All plumbing should be done in accordance with national and local codes.

These instructions depict an installation method for stainless steel braided hose or PEX hot water supply lines. If using copper tubing or other material for water supply, defer to a licensed plumber for proper installation.

## 2 INSTALLATION

### 2.1 Pre-Install checklist

- Unpack unit. Retain packing material until installation is successful. Remove packing material from inside the dishwasher.
- Inspect parts to ensure you have all the necessary materials.
- Flush household hot water supply for at least two minutes.
- Measure the enclosure area. The opening must be at least 34" (87 cm) high and 23-5/8" (60-61 cm) wide.
- The opening must be close enough to the sink for water line and drain hose plumbing access.
- Unit must be installed close enough to the sink so that drain hose length does not exceed 92" (234 cm) and a high loop is raised at least 20" (51 cm) above the floor.
- Wooden openings must be sanded smooth and metal openings must be covered by a protective gasket.
- Is your water heater set at 120°F (49°C) and does water pressure measure 15-145 psi (1-10 bar)?
- If installing in a corner, the dishwasher door must clear cabinet hardware.
- Determine mounting method based on dishwasher model and countertop type, whether top or side mount.

### 2.2 Alignment

Gently rest the unit on its back, taking care not to crush the drain hose. Remove the toe panel(s). Loosen front feet slightly. Remove junction box cover and retain for later use. Place dishwasher upright, then level side to side and front to back.

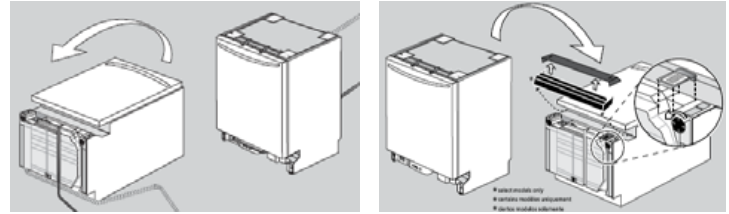

If your dishwasher has pre-attached mounting brackets and you have a wooden under-counter, position brackets as far apart as possible by sliding them within slots in direction of arrows. Do not attach them to the countertop yet.

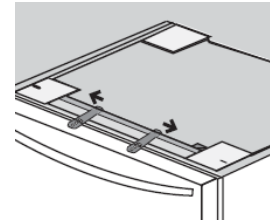

If your dishwasher has pre-attached mounting brackets and the counter top is stone, use pliers to rotate bracket flanges to remove brackets from the top. Grasp brackets with pliers at perforation and bend until the rounded end breaks free. Discard the ends. Slip brackets through side slots. Using pliers, bend bracket flanges so the brackets will not slip through slots. Do not attach them to the countertop yet.

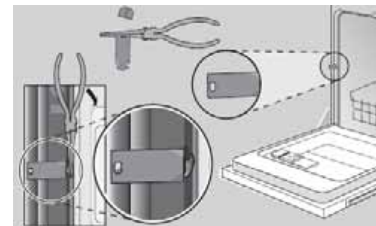

## 2.3 Electrical connection

Install according to national and local codes.

Carefully place dishwasher on its back to make electrical connections to the terminal block. Turn power off at the fuse box. Extend power cord approximately 21" from the left side of the opening, and 30" from the back wall, making sure the cord doesn't contact any moving parts.

Strip outer casing of electrical wire to expose 2.5" - 3" (65 - 76 mm) of inner wires, then strip 1/2" (13 mm) casing from each wire. If plugging the dishwasher into an outlet, contact customer service to order power cord accessory kit (**SGZPC001UC**). Insert cord through a strain relief (not included) and install to strain relief plate. Attach wires to terminal block (black – **L** (hot), white – **N** (neutral) & green – **G** (ground)). Unscrew terminal screws, *but don't loosen or remove them as they may become damaged.* Attach wires snugly, *but don't overtighten.*

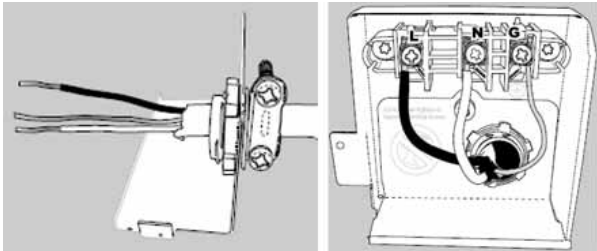

## 2.4 Water connection

Install according to national and local codes.

Carefully place dishwasher on its back to make water connections to the water inlet valve. Use a 90° elbow fitting with Teflon tape as needed. Don't overtighten.

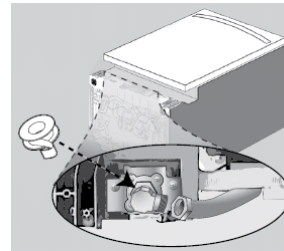

Attach the hot water line to the 90° elbow and route it underneath the unit toward the hot water connection. Make sure the line doesn't contact any moving parts.

## 2.5 Drain and condensation hose connections

Plumbing installations will vary - refer to local codes. The maximum length of the drain hose, including leading to an air gap (if any) is 150" (381 cm). Make sure a high loop is raised at least 20" (51 cm) above the floor.

Drain hose has its own adapter – connect directly to plumbing connection and secure with supplied hose clamp. Don't connect to condensation hose.

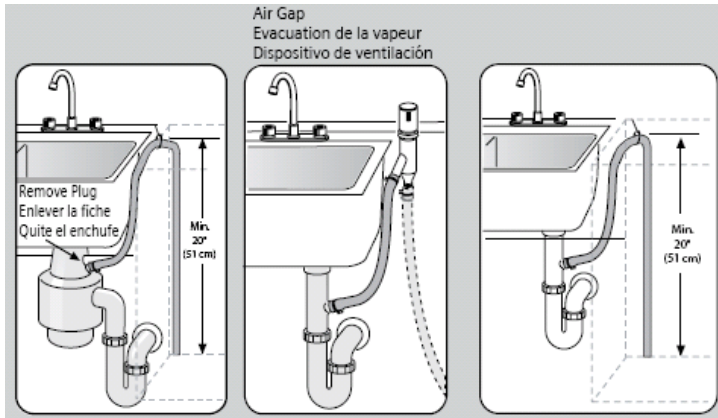

### 3 OPERATION

#### 3.1 Control layout

##### 3.1.1 SHE models



SHE55P



SHE43P15

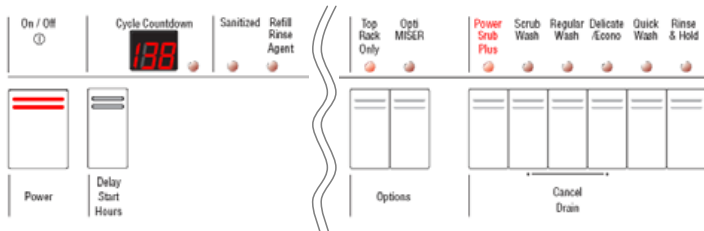

SHU66C

##### 3.1.2 SHX / SHV models



SHX46A



SHV66A

##### 3.1.3 Features

The *Sanitized* light comes on after certain wash programs have finished, showing dishes have been sanitized according to NSF standards. Check the Use & Care manual for your model to confirm which programs qualify as NSF rated.

The *Refill Rinse Agent* light shows rinse-aid needs to be added.

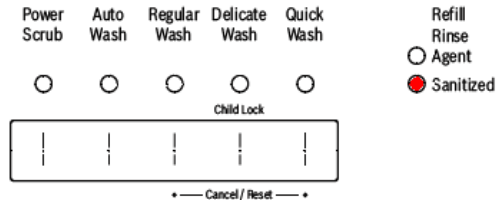

## 3.2 Reset (“Cancel – drain”)

To reset, push *Cancel-Drain* or *Cancel-Reset* buttons at the same time.

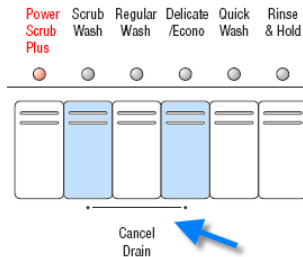

## 3.3 Changing basic features (on selected units)

On some models, features can be changed on the fascia panel.

### 3.3.1 Extra dry heat

With *Extra Dry Heat*, the temperature of the rinse water can be raised and the drying time increased for improved drying.

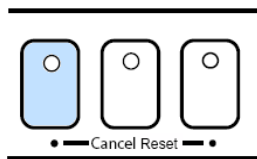

- Turn the dishwasher off and then push and hold the left *Cancel Reset* button while turning the dishwasher on – release buttons when the display shows “0” or “1”.
- Pushing the left *Cancel Reset* button changes the setting – choose “1” to turn it on and choose “0” to turn it off. Push the on/off button to save the setting.

### 3.3.2 End of cycle tone

The *End of cycle tone* volume can also be changed.

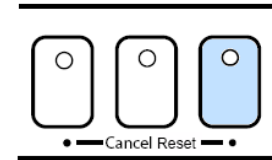

- Turn the dishwasher off and then push and hold the right *Cancel Reset* button while turning the dishwasher on – release buttons when a tone sounds or the right *Cancel Reset* button LED lights up.
- Pushing the right *Cancel Reset* button changes the setting – push it until the tone is at the desired volume (or the tone stops if it’s to be turned off). Push the on/off button to save the setting.

## 3.4 Entering special programs and coding

Controls contain codes for sales demo mode, factory tests, customer service test program, dishwasher configuration and error codes. Consult test programs and error codes for your dishwasher before using the codes listed in this manual.

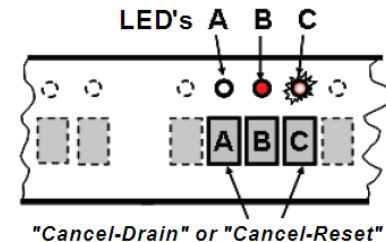

While pushing (and holding) **any two** wash cycle buttons, turn the dishwasher on with the on/off switch. The current coding (e.g. “C1”) will show in the display or LED’s until you release the buttons. After releasing the buttons, LED “B” will be lit and LED “C” will flash, confirming you’re in the special programs menu. Push button “B” repeatedly until you’ve selected your desired program (see *P(X) Program codes*, “P1” or “P4” -- programs “P0” and “P3” are factory tests that aren’t to be used).

The following typical codes cover most dishwashers. Consult the test program for your model to confirm the codes to use.

### 3.4.1 Typical P(X) Program codes

---

- P0 = Functional test - used for assembly (do **not** use)
- P1 = Customer service test program (see *E(X) error codes*)
- P3 = Endurance / Life test (do **not** use)
- P4 = Control coding (see *C(X) control codes*)

### 3.4.2 Typical E(X) Error codes

---

- E0 = No errors
- E1 = Heating error
- E2 = NTC error
- E3 = Filling error
- E4 = Water switch cannot be positioned
- E5 = Safety float water level reached or motor speed error (error code dependent on model – check test program)
- E6 = Aqua sensor error

### 3.4.3 Typical C(X) Control codes

---

- C9 = Sales demo mode

Codes C1 through C9 are possible, depending on the model.

**HINT:** Customers pushing and holding *Cancel-Drain* or *Cancel-Reset* buttons while turning dishwashers on can see strange

displays. Whenever you get call about a “strange” display, check if the customer put the dishwasher into the test program or some other program.

### 3.4.4 Sales demo (showroom) program

---

#### 3.4.4.1 Entering sales demo program

---

Enter the special program mode – see section 3.5. Before releasing the two buttons held while you turned the dishwasher on, note the coding on the digital display (e.g. “C1”, “C2”, etc) -- the dishwasher must be returned to this code for resale.

Push button “B” repeatedly until the display shows sales demo program mode “P4”. Push button “C” to confirm it.

Push button “B” repeatedly until the display shows sales demo code “C9”. Push button “C” to confirm it.

Turn power off and then back on. The dishwasher is now in demo mode -- all button lights will light up.

#### 3.4.4.2 Preparing a dishwasher for showroom use

---

1. Turn off the power to the dishwasher or disconnect the dishwasher from the electrical power.

**⚠ WARNING:** Danger of electrical shock!

2. Remove the toe kick and locate the drain pump terminal shown below. Disconnect the terminal from the drain pump by squeezing and pulling it out. Cover the terminal with electrical tape to prevent electrical shock.





3. Disconnect both ends of the short heater **red** wire – see section 5.2.3 to remove right side panel for access. Tape the wire with electrical tape to the plastic base so it can be reconnected for resale.

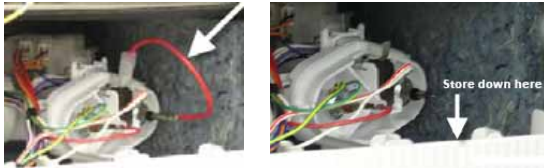

4. Do NOT connect dishwasher to a water line, but slowly pour about 4.5 liters of distilled water into the tank. The water level should be near the bottom of the fine filter screen in the sump.
5. Add a small amount of rinse aid and a 1/2 capful of antibacterial agent (bacteriostat) onto the inner door. Do NOT add bleach.
6. Reconnect the dishwasher and turn it on by pushing the on/off button. Close the door and run dishwasher for one minute. If necessary, add more water until level reaches the fine filter screen.

### 3.4.4.3 Preparing a showroom dishwasher for resale

To return the dishwasher back to it's original condition for resale, enter the special program mode – see section 3.4. Push button “B” repeatedly until the display shows sales demo program mode “P4”. Push button “C” to confirm it.

Push button “B” repeatedly until the display shows the original dishwasher code (e.g. “C1”, “C2”, etc). Push button “C” to confirm it.

Turn power off and then back on. The dishwasher now has it's original coding. Reconnect the pump and heater that was previously disconnected.

## 3.5 Dispenser

### 3.5.1 Adjusting rinse-aid dosage

The amount of rinse-aid can be adjusted at the dispenser.

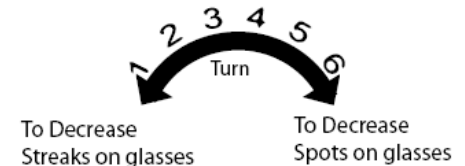

Rinse-aid can be added by pouring it onto the arrow.

### 3.5.2 Closing dispenser doors

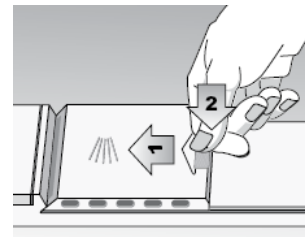

1. Slide cover fully left.
2. Push back end of the cover (onto the arrow) down firmly until you hear a click.

## 4 COMPONENTS

### 4.1 Dishwasher components

#### 4.1.1 Tank

The tank, made of 304 stainless steel, isn't available as a service part.



#### 4.1.2 Leveling feet (front and rear)

The base is supported by three leveling feet, two front and one rear. The rear leveling foot is adjusted from the front. Front feet have provisions for set screws (in installation parts bag).

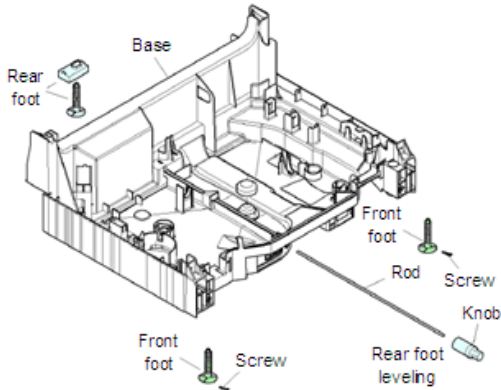

### 4.1.3 Heater

#### 4.1.3.1 Operation

Bosch dishwashers use flow-through heaters instead of exposed elements, saving space and allowing taller tanks holding larger dinner plates. Flow-through heaters prevent dishware damage from exposed elements and allow water to be continuously filtered and heated.

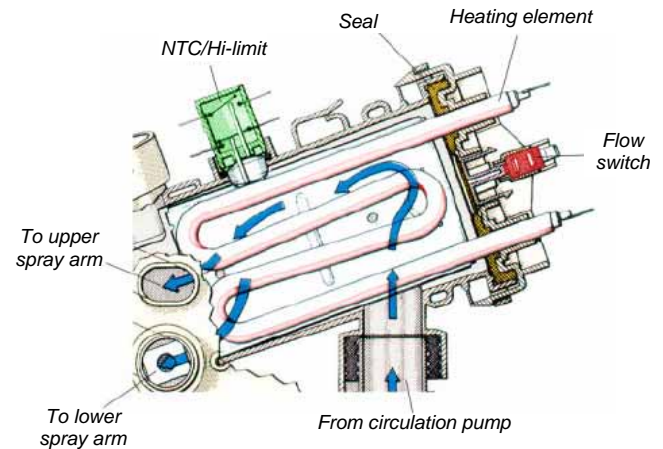

Filtered water from the sump flows through the circulation pump into the flow-through heater. All heaters are protected by a 185°F Hi-limit (high temperature cutout) and by a flow switch which prevents heaters from operating when no water is flowing.

#### 4.1.3.2 Heater ratings

- 120 VAC, 60 Hz, 1200 W
- Heats water about 2°F / minute

### 4.1.3.3 Softer bearing (UC/11 and later)

Softer bearing (UC/11 and later) & non-softer bearing (UC/06) heater assemblies, circulation pumps and sumps **cannot** be mixed and matched. Softer bearing heaters don't fit in older models and older heaters don't fit in softer bearing models.

Softer bearing & non-softer bearing heater assemblies are connected to circulation pumps differently:

- Softer bearing models (UC/11 & above) have gasket assembled to heater and have a separate hose clamp (order # **172272**).
- Older models (UC/06) have a separate gasket and do not have a hose clamp.

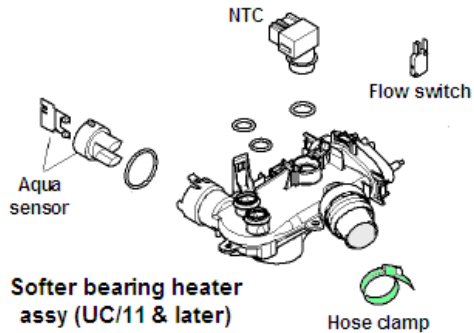

### 4.1.3.4 Top Rack Only

Models with *Top Rack Only* have separate actuators mounted underneath heater assemblies. The actuator moves a magnetic float to block the lower rack port, diverting water to the top rack.

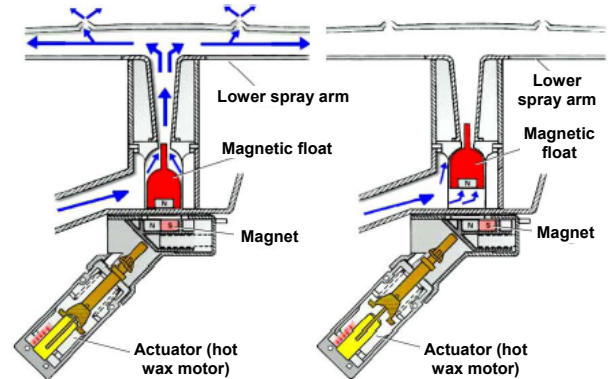

The actuator moves a magnet under the magnetic float so the north poles align, repelling the magnetic float upward until it blocks the water flow to the lower spray arm.





Where plunger engages heater

Where plunger engages sump

#### 4.1.3.5 Half Load

Starting with UC/33 dishwashers, *Half Load* replaced *Top Rack Only*. Like *Top Rack Only*, it uses 30% less water, saving water and energy. Unlike *Top Rack Only* with mechanical actuators, *Half Load* is done by control software (through shortening cycles) and doesn't limit water flow to the top rack.

#### 4.1.3.6 Water switch

Motor operated water switches are mounted underneath heater assemblies. They consist of a motor-controlled disk with 3 holes which rotates and lines up over two sump ports (upper / lower spray arms) to provide precise water control to upper, lower or both spray arms.

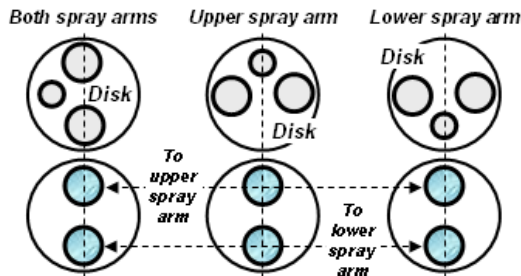

Models with water switches & *Top Rack Only* use water switches to divert water. Separate actuators aren't needed.

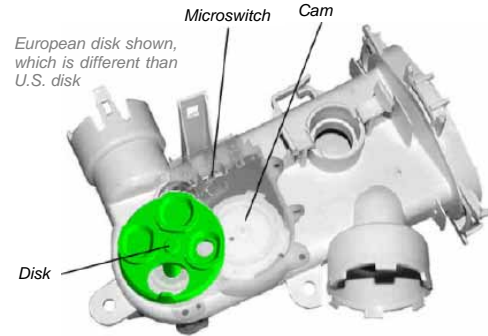

Models with water switches need stronger circulation pumps (# 437345) with separate motor starters (# 182318). Circulation pumps, heaters & sumps for water switch / non-water switch models **can't** be interchanged.

#### 4.1.4 Circulation pumps

Bosch dishwashers use separate circulation and drain pumps to reduce overall size, noise, vibration and energy consumption. This allows the use of tall tanks, increasing overall space inside dishwashers where full-sized plates can be placed in both upper and lower racks. Circulation pumps are suspended by rubber straps to further reduce noise and vibration.

Depending on features, dishwashers have one of four types of circulation pumps. Pumps use different controls, wire harnesses, heaters & sump filters, so replace with identical replacement pumps.

#### 4.1.4.1 “Sisme” (UC/06 through UC/23)

It has a capacitor start motor with a centrifugal switch cutting out the starting capacitor once the motor comes up to speed. This pump can be replaced as # **239144** pump assembly, # **266511** motor only or # **167085** impeller kit.



It has a ceramic seal keeping water from entering the motor and an 8mm nut on the impeller to free it if it should ever stick.

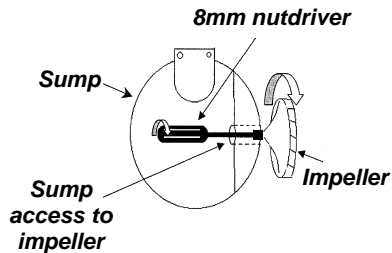

#### 4.1.4.2 “Sisme” pump with PTC motor starter

Pump # **437345** pump is more powerful for use with heaters with water switches and sumps with extra filter cylinder. It uses a separate motor starter (# **182318**) attached to the motor terminals. It can use # **167085** impeller kit.



The (PTC) circulation pump motor starter cuts out the start winding after the motor starts.

#### 4.1.4.3 “Sicasym” (UC/21 through present)

Most common pump (used starting with UC/21 index). Smaller than **239144** “Sisme” pump. Used with controls & single wire harnesses designed for Sicasym pumps. Motor controls have motor starter software, so there are no mechanical starters.



There is no impeller kit.

#### 4.1.4.4 BLDC (UC/46 through present)

Pump, motor and control come as one unit (# **665510**). Speed changes as needed for wash cycle and washability (*Vario wash*). Pump is isolated from motor, so there's no seal needed and no need to loosen or replace impellers.



#### 4.1.5 Float

The float is a safety device which starts the drain pump if there's too much water in the tank. It doesn't act like a bilge pump (i.e. it won't drain water from the base).

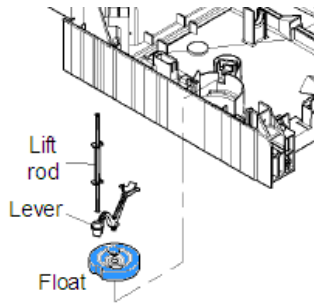

If there's water in the base or the float switch isn't working, error code **E5** is possible (except for models where **E5** = motor speed error).

#### 4.1.6 Drain pump

Drain pumps are mounted to sumps in the front of dishwashers -- they're easily accessible from the front of dishwashers by removing toe kicks.

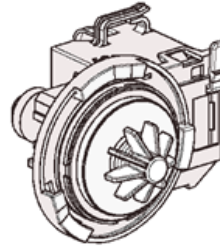

#### 4.1.6.1 Pump specifications

Drain pump is rated 120V, 60 Hz, 35W, 0.85A.

#### 4.1.6.2 Solving installation issues

Often improper installations, not drain pump issues, cause dishwashers to not drain properly.

- Must have drain hoses with high loops (min. 20" high) or drains with air gaps.
- Drain hoses are 6' long and can be up to 10' long. Drain hose extension kit **SGZ1010UC/01** (76.75") is available.
- Secure drain hoses to rear of dishwashers with non-metal bands.
- Make sure drain hoses aren't kinked.

#### 4.1.6.3 Cavitating

*Cavitating* may occur in any type of pump when impellers spin faster (from low inlet or outlet pressure), creating air pockets around impellers. Cavitating pumps can be noisy. Air gaps/high loops keep water contacting pump outlets, preventing air pockets from forming.

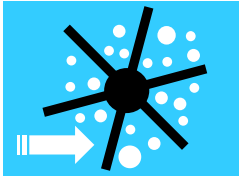

#### 4.1.6.4 Siphoning

*Siphoning* may occur in any type of drain pump when low water flow allows a siphon (suction) to develop, pulling waste water back into the pump. Sump check valves along with air gaps/high loops prevent siphons from being created.

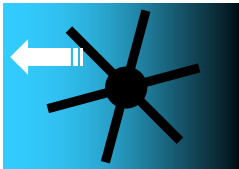

#### 4.1.6.5 Terminal connections

Drain pump terminals were changed from spade type to (Rast 5) connectors during November, 2006 and can't be interchanged.

#### 4.1.6.5.1 Spade terminals (UC/42 and before)

Wire harnesses to drain pumps have locking spade terminals, which must be released using a small blade screwdriver.

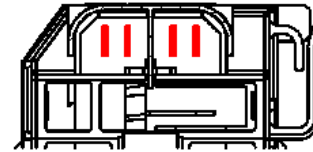

Drain pump spade terminals

or

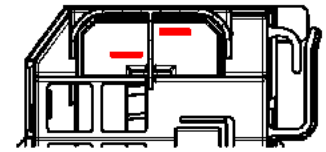

Drain pump spade terminals

#### 4.1.6.5.2 Rast 5 connectors (UC/43 and later)

Rast 5 terminal connectors provide more positive connections than spade terminals.

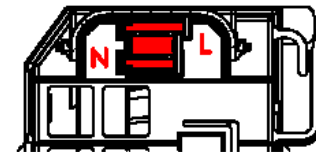

Drain pump Rast 5 terminals

#### 4.1.6.6 Johnson Tee installations (Washington State)

Drain pumps in installations with Johnson Tees (in Washington State) must use stronger 4-vane pumps (# 184178 *spade* / 607468 *Rast 5*).

Standard 9-vane drain pumps (# 167082 *spade* / 642239 *Rast 5*) are quieter and smoother than 4-vane pumps. Older spade terminal pumps had 6-vanes.



#### 4.1.7 Water fill assembly

The water fill assembly is easily accessed from the left side by just removing the left side panel. It can be a pressure-fill (with diaphragm) or time-fill, depending on model.

##### 4.1.7.1 Pressure fill

Pressure-fill assemblies use a diaphragm to accurately measure water levels.

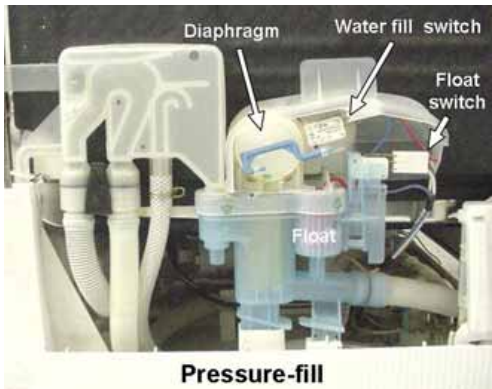

During normal fill, rising water compresses air in a chamber until the diaphragm operates when the proper water level is reached.

If water overfills, the float (shown in red below) stops the water fill and operates the drain pump. This float is connected to the float in the base – either float operates the drain pump.

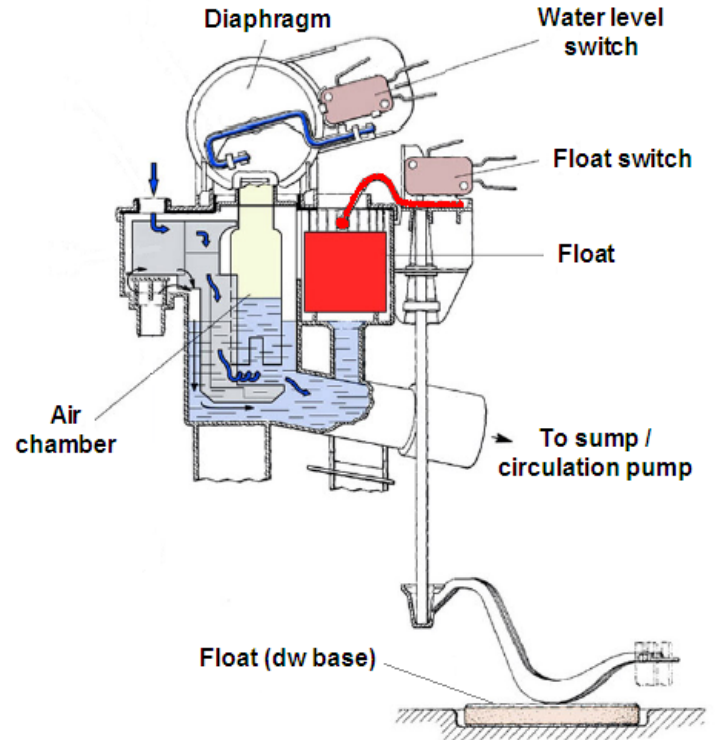



#### 4.1.7.2 Time fill

The time-fill water inlet system is similar to the pressure-fill system, except it doesn't have a diaphragm or water level switch. Dishwasher controls allow water to fill for a specific time, relying on consistent water flow through the water inlet valve to provide the correct water level.

Time-fill water valves look like pressure-fill valves, but have tight part tolerances to insure consistent water levels. Time-fill valves can replace pressure-fill valves, but pressure-fill valves can't replace time-fill valves.

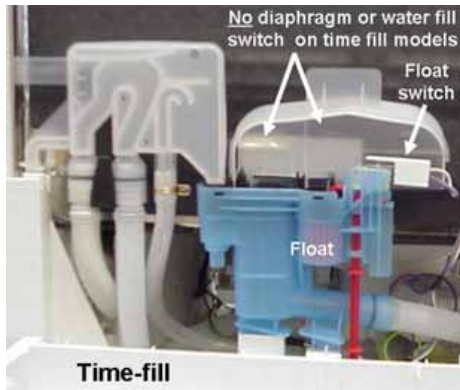

#### 4.1.8 Condensation tube

The condensation tube is crucial for condensation drying, which dries dishes without a heating element in the bottom of the tank. Starting with UC/12, condensation tubes were moved from the dispenser to the right side of the tank.

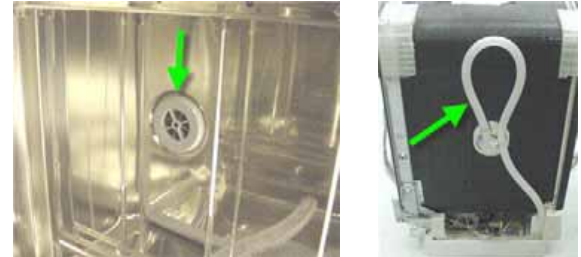

Condensation tubes exit in the rear of dishwasher bases, allowing water vapor to evaporate, and aren't connected to customer drains.

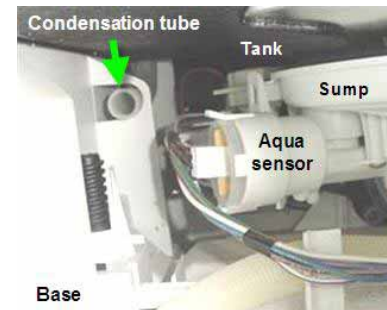

## 4.1.9 Door spring

### 4.1.9.1 Using hinge pulley

The door spring mechanism allows dishwasher doors to open / close with little effort and to stay open when racks are loaded or unloaded.



The door spring connects to the cord and slides into slots in the rear corners of the base. Springs are color coded for specific tensions for specific door weights.

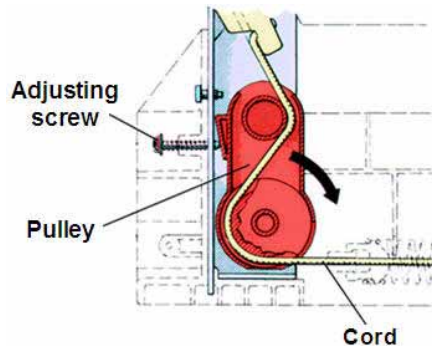

Dishwashers with wood doors have adjusting screws to change spring tension for different wooden door panel weights. Tighten screws (cw) to increase spring tension and loosen screws (ccw) to reduce tension.

Dishwashers with heavy or light wood doors will need door springs changed. The following chart shows when to adjust tension screws and when to replace door springs.

Existing Door Spring	Door Wood Panel Weight				
	Less than 5.5 lbs (2.5 kg)	5.5 to 9 lbs (2.5 to 4.1 kg)	9 to 15 lbs (4.1 to 6.8 kg)	15 to 18 lbs (6.8 to 8.2 kg)	18 to 21 lbs (8.2 to 9.5 kg)
<b>Violet (168568)</b>	Change to <b>173696 Yellow</b> spring - use tension screw if needed	Change to <b>168576 Blue</b> spring - use tension screw if needed	No action	Use tension screw to increase tension	Change to <b>182640 Orange</b> spring - use tension screw if needed
<b>Orange (182640)</b>	Change to <b>168576 Blue</b> spring - use tension screw if needed	Change to <b>168568 Violet</b> spring	No action	Use tension screw if needed to increase tension	Use tension screw to increase tension

#### 4.1.9.2 Using hinge slider (sliding pulley)

During FD 8910, hinge pulleys were replaced with hinge sliders (sliding hinge pulleys). Instead of rolling over rotating pulleys, door spring cords slide over pulley sliding surfaces. The sliding surfaces provide better control than rotating pulleys (i.e. reduces possibility of doors slamming closed or falling open).



**618605** sliding hinge pulley kit replaces all prior pulleys, including **426067**. The kit consists of (2) sliding pulleys and (2) cords which are installed in the field.

	Existing Door Springs	Door Weight			
		Less than 7 lbs (3.2 kg)	7 to 20 lbs (3.2 to 9.1 kg)	Greater than 20 lbs (9.1 kg)	Greater than 22 Lbs (10 kg)
All fully integrated dw's with 618605 sliding hinge pulleys	<b>Violet (168568)</b>	Change to <b>168576 Blue</b> springs.	No changes needed.	Add (2) <b>169525</b> adjusting screws or change to <b>187527 Orange</b> springs.	Not Recommended
	<b>Orange (187527)</b>	<b>Not used.</b> If replacing pulleys on older units with 618605 sliding pulleys, change springs from <b>Orange (187527)</b> to <b>Violet (168568)</b> .			

**NOTE:** Dishwashers with 618605 sliding hinge pulleys (i.e. all dw's produced after FD8910) don't include 169525 adjusting screws. If needed, they must be purchased separately.

#### 4.1.10 Hinge bushing

Hinge bushings hold doors in place (at hinges). Older hinge bushings used a separate lock. Newer hinge bushings have latches holding doors in place. Bushings have different diameters and can't be mixed. Bushings can be changed as long as matching hinge levers are used.

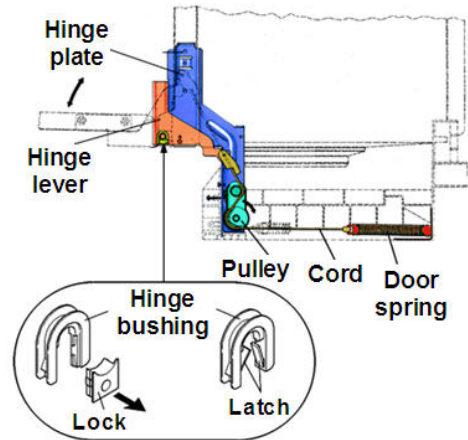

Replacement Hinge Levers and Bushings					
Side	Part #	Description	Replaced by	Description	
Left	492033	Lever (14mm)	494876 + 165296	Lever + bushing (15mm)	
Left	488250	Bushing (14mm)	494876 + 165296	Lever + bushing (15mm)	
Left	263115	Lever + bushing (14mm)	494876 + 165296	Lever + bushing (15mm)	
Right	492034	Lever (14mm)	494875 + 165296	Lever + bushing (15mm)	
Right	488250	Bushing (14mm)	494875 + 165296	Lever + bushing (15mm)	
Right	263119	Lever + bushing (14mm)	494875 + 165296	Lever + bushing (15mm)	

#### 4.1.11 Water inlet valve

Dishwashers use standard horizontal coil water inlet valves. Dishwashers UC/43 and later have valves with (Rast 5) connectors. The valve nestles in the left side of the base and is held into place with two screws.



- When reconnecting the water supply to the water valve, don't overtighten the elbow fitting. On valves with vertical solenoids, the plastic can crack and cause leaking if excessive force is used.
- Using Teflon tape on water fittings can help prevent leaking.
- The water valve can be accessed without removing outer door or base cover. However, removing them will provide easier access.

#### 4.1.12 On/off switch

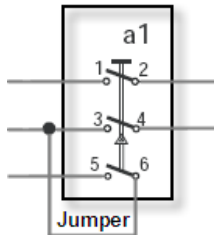

The on/off switch turns the dishwasher on and off and is crucial in resetting controls.

Contacts 5 & 6 reset the control. Whenever a control won't reset or won't go into wash programs, check the on/off switch and jumper. Replace switch and jumper if they're faulty.

#### 4.1.13 Door latch



Other than occasional misalignment, the only door latch repairs will be replacing microswitches. Door latches are held in place in console (frames) by tabs. It's important latches are properly seated in consoles and tabs are fully inserted into latches.

#### 4.1.14 Terminal block

Terminal blocks (UC/40 and later) clearly show line (L), neutral (N) & ground (G) connections. Dishwasher wire harnesses have spade terminals which connect to terminals on the rear of the terminal block.



Terminal blocks can't be installed in the field – the terminal box assy with terminal block must be ordered. The terminal box assy assures the terminal block is properly grounded to the terminal box.

#### 4.1.15 Terminal box

Since 9/23/02, all dishwashers have terminal boxes ("junction boxes" / "J-boxes") with covers. Boxes were upgraded to a larger style (with conduit exits) on 3/18/03.

Used from 9/23/02 – 3/17/03.

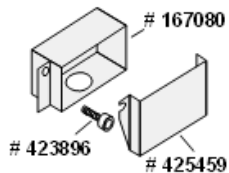

Old terminal box with cover

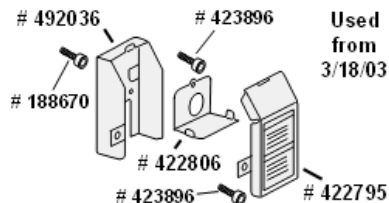

Used from 3/18/03

Upgraded terminal box with cover

**NOTE:** Old terminal boxes built before 9/22/02 met UL standards – toe kicks were approved as terminal box covers. There's no need to change out old terminal boxes. Covers can't be added to these boxes since they don't have cover screw holes.

#### 4.1.16 Drain hose

Dishwashers UC/48 and later use a two-hose (internal / external) drain hose system. A customer (external) drain hose (during installation) is connected to the internal drain hose, with the 90° elbow pointing toward the customer drain. The external drain hose connects directly to the customer drain system without an adapter.

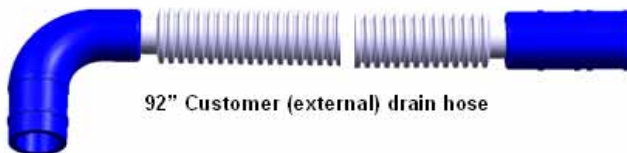

92" Customer (external) drain hose

#### 4.1.17 Dispenser

The dispenser is located near the top of the inner door and reliably dispenses detergent and rinse-aid.



During each wash program, the wax motor opens twice, once to dispense detergent and again to dispense rinse-aid. The wax motor opens the same -- linkages open the detergent door & operate the rinse-aid dosage plunger. Dispensers can have reed switches or optical rinse-aid sensors.

**CAUTION:** Inner door edges are sharp! Cover door edges and remove dispenser carefully.

#### 4.1.17.1 Reed switch dispensers

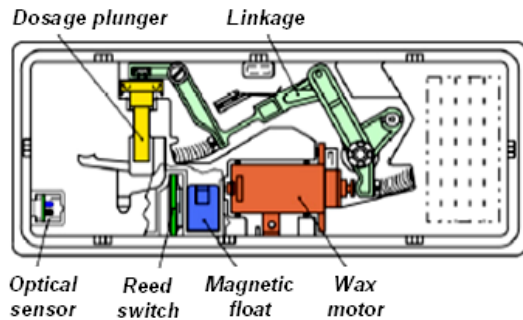

The white plastic linkage opens the detergent dispenser door, then cocks in place to dispense rinse-aid when the wax motor operates again. After the 2nd operation, the linkage resets for the next wash.

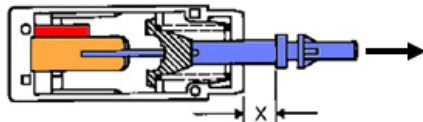

A wax motor heats wax, which expands and pushes a plunger. When the wax cools, a spring pushes the plunger back.

#### 4.1.17.2 Optical dispensers

Optical dispensers are connected differently and can't replace reed switch dispensers.

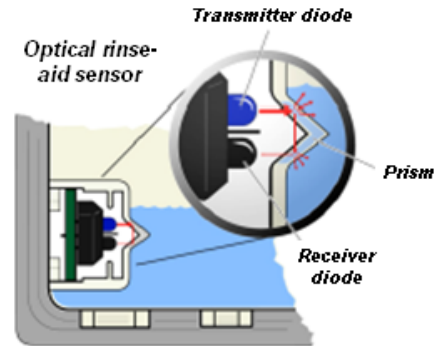

With rinse-aid present, the optical receiver senses a diffused light beam.

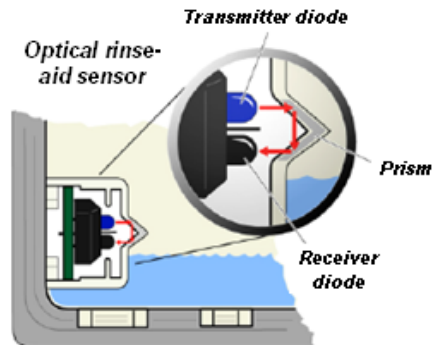

When rinse-aid has run out, the optical receiver senses a strong light beam.

**When rinse-aid has run out, the optical receiver senses a strong light beam.**

**TIP:** It's possible for some clear rinse-aid brands to not diffuse light adequately to show rinse-aid isn't needed.

### 4.1.17.3 Top load dispensers

**431413** top-load dispensers enable detergent and rinse-aid to be added while doors are partially open (preferably @ 45°). The dispensing mechanism uses a solenoid instead of an actuator (wax motor).

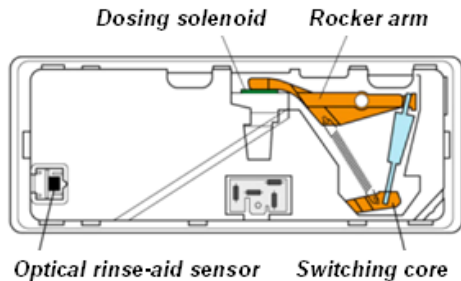
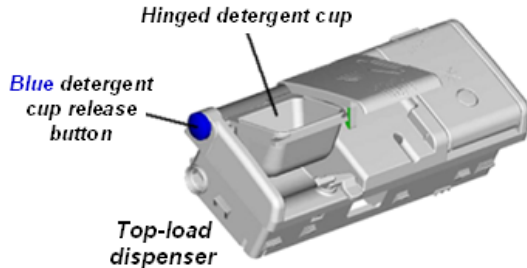

The plastic linkage opens the detergent dispenser door when the solenoid first operates, then cocks in place to dispense rinse-aid when the solenoid operates again. After the 2nd operation, the linkage resets for the next wash.

Rinse-aid dosage is shown on the digital display and is changed through the dishwasher controls, not through a dispenser dial.

### 4.1.18 Aqua sensor

The aqua sensor is located behind the sump, to the left of the heater. It's a two-piece assembly, with a small circuit board in a plastic housing. It senses water cleanliness and allows the dishwasher control to remove pre-wash and/or pre-rinse cycles to save energy (~ 20% energy savings).

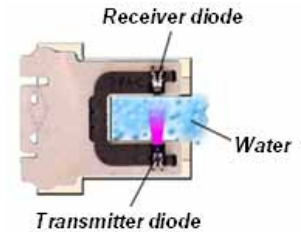

If water is clean enough, it will be kept for the wash cycle. If not, the aqua sensor directs the dishwasher to add an additional pre-rinse or pre-wash cycle.

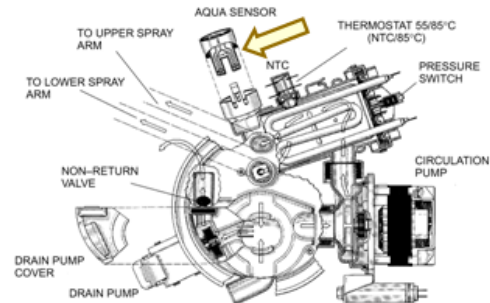

Dishwashers still operate adequately when aqua sensors fail. Customers will only notice aqua sensors failing if they see their dishwashers running slightly longer or their electric and water usage getting slightly higher.

## 4.1.19 Display and power modules

Dishwashers can have from one to three controls, depending on the model: a control module (in the fascia / control panel), a display module with display, lights & buttons (in the fascia / control panel) and a power module in the base on the right side. The power module controls the circulation and drain pumps, while the control module controls the wash programs.

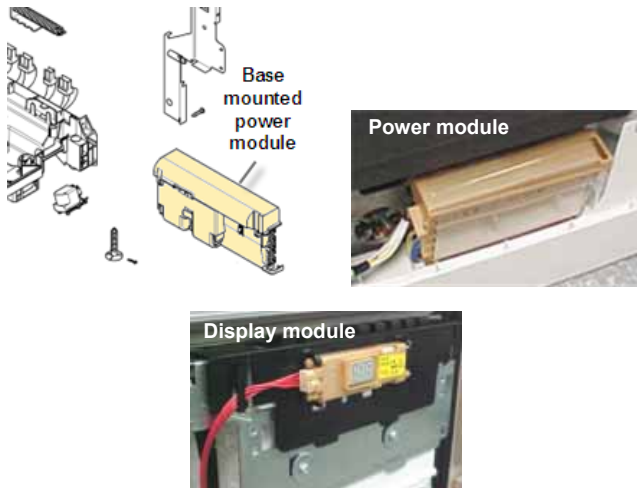

## 4.1.20 Sump parts

### 4.1.20.1 Sump

The sump contains a filter screen, large item (coarse) filter and micro filter.

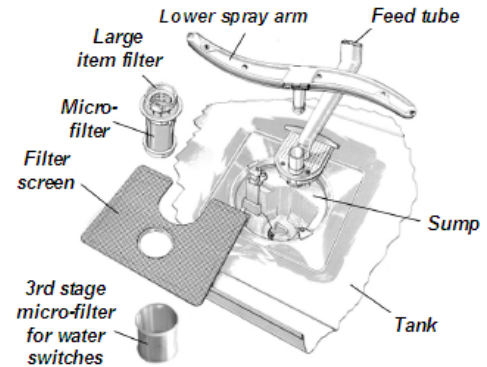

The sump holds the drain pump cover and suction cap. The suction cap, used only with Sicasym circulation pumps, provides a proper flow rate of water through the sump.

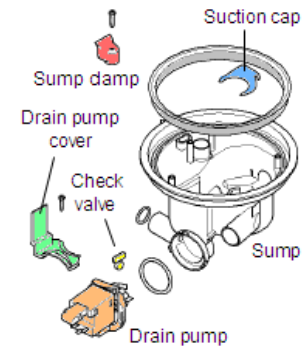



### 4.1.20.2 Backflow (check) valve

The backflow (check) valve is located in the bottom of the sump near the circulation pump inlet. It prevents waste water from entering the sump.

Occasionally, older (black) check valves (used mid 2003 & earlier) have swelled, allowing water to trickle out during washing. The newer (clear) material doesn't swell – newer shape provides improved seating after many uses. Part # is still **165262**.



**TIP:** When washability issues arise, replace check valve along with other repairs.

### 4.1.20.3 Spray arm feed tube

When water doesn't spray from upper spray arms, check feed tube where it enters the sump. Occasionally, the joint between the feed tube and its base can loosen -- the entire feed tube must be replaced.

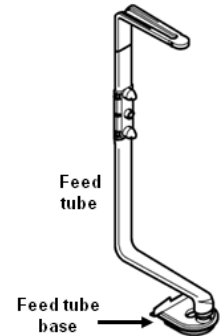
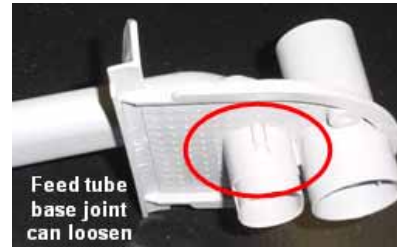

### 4.1.21 Info lights

Many high-end models have info lights, which shine a **red** light onto floors, letting customers know their quiet dishwashers are running. When dishwashers finish wash cycles, info lights shut off.

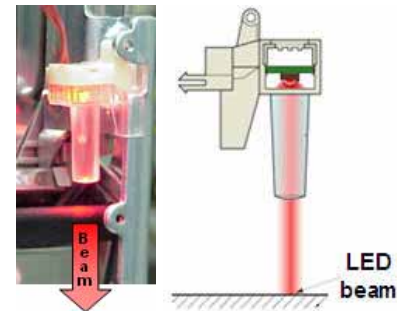

## 4.2 Operation

### 4.2.1 Water circulation

The circulation pump pumps water from the sump through a triple filter system to the heater. When water enters the heater, a flow switch determines water is present and allows the heater to be activated. As water flows, it's heated until it reaches the pre-set temperature determined by the cycle. Once it leaves the heater, it flows through the sump into the upper and lower spray arms.

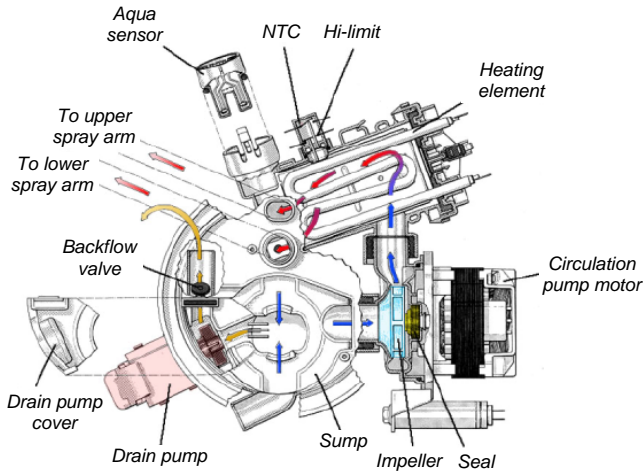

The aqua sensor, drain pump, NTC, Hi-limit and backflow valve are near the heater under the sump. The aqua sensor senses water cleanliness – dishwashers add or subtract rinses as needed. The NTC senses water temperature. The Hi-limit shuts off the heater if the water gets too hot. The backflow valve prevents waste water from entering the dishwasher.

## 4.3 Serial label (warranty information)

The serial label, located on the right side of the inner door, contains the dishwasher model, serial and index (KI) #'s.



### 4.3.1 Understanding the FD # (customer serial #)

This is the serial # used for customer and warranty repairs, commonly known as the "FD #". It's located under the model #.

#### FD8303 00011

The FD # shows the production date:

- The first 2 #s represent the year: 83 = 2003
- The next 2 #s represent the month: 03 = March
- The next 5 #s represent the unit made that month: 00011 = 11th SHY99A05UC made that month

---

### **4.3.2 Understanding the 17-digit factory serial #**

---

This is a more detailed serial # used by the factory for analysis of returned units. It's located in the bottom right corner of the label.

**10 3 03 0081344 00011 5**

- The first 2 #'s represent a factory code: **10** = New Bern dishwasher, **82** = New Bern cooking
- The 3rd # represents the last digit of the year: **3** = 2003
- The next 2 #'s represent the month: **03** = March
- The next 7 #'s represent the model: **0081344** = SHY99A05UC
- The next 5 #'s represent the unit made that month: **00011** = 11th SHY99A05UC made that month
- The last # represents a check digit = **5** in this case (is dependent on all preceding #'s)

## 5 REPAIR

### 5.1 Water valves

Access the water valve from the front of the dishwasher base by removing the toe kick.

#### 5.1.1 To remove water valve

*Tools needed: T20 Torx screwdriver & pliers.*

1. Remove two (2) T-20 Torx screws from toe kick and tilt toe kick out from under dishwasher.
2. Remove base insulation (on models with insulation).
3. Move sump inlet hose away from water valve (without disconnecting it).
4. Disconnect wires from water valve, including ground wire.
5. Remove two (2) T-20 Torx screws from water valve.
6. Pull valve out from dishwasher and disconnect water hose from rear of valve. Remove any water from sump & base.



#### CONNECTION HINTS:

- Water connection 3/8" NPT female. Inlet water pressure range 5 - 120 psi (0.3 – 8.27 bars).
- When reconnecting the water supply to the water valve, don't overtighten the elbow fitting. On valves with vertical

solenoids, the plastic can crack and cause leaking if excessive force is used.

- Using Teflon tape on water fittings can help prevent leaking.
- The water valve can be accessed without removing outer door or base cover. However, removing them will provide easier access.

### 5.2 Circulation pumps

The circulation pump is accessed from the right side of the dishwasher by removing the right side panel and blocking the tank. Use same process to access the heater & base mounted controls.

#### 5.2.1 To remove outer door

*Tools needed: T20 Torx screwdriver.*

1. Remove six T-20 Torx inner door screws below fascia panel -- three per side (1).
2. Carefully pull bottom of outer door out from dishwasher until top door tabs clear, then pull door down until it releases from dishwasher (2). Take care to not scratch outer door.
3. Remove door guards, whether 1-piece foam or two plastic guards (3). The plastic door guards occasionally fall out when the outer door is removed.



## 5.2.2 To remove toe kick

Tools needed: T20 Torx screwdriver.

1. Remove two T-20 Torx screws from toe kick (1).
2. Tilt toe kick out from under dishwasher (2).



## 5.2.3 To remove right & left side panels

Tools needed: T20 Torx screwdriver.

Dishwashers may have long or short side panels. Removing the left side panel allows the right side of the tank to be blocked.

1. For models with long side panels, remove two T-20 Torx screws through holes in side trim strips (1).
2. To remove long side panels, lift panels with trim strips up and out from dishwasher (2).
3. To remove short side panels, remove two T-20 Torx screws (3). To avoid damaging trim strips while blocking tanks, slide them up until they clear dishwasher bases.
4. To remove right side plastic side panels, tilt top of panel and lift out. Blocking the tank up makes it easier.

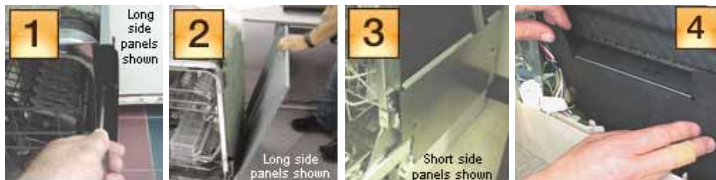

## 5.2.4 To raise tank for circulation pump access

Tools needed: T20 Torx screwdriver and pliers.

1. Remove one T-20 Torx screw from both rear corners holding tank to base (1) -- removing screw from both sides allows tank to be blocked upward.
2. Remove right toe kick bracket by removing T-20 Torx screw (2).
3. Remove T-20 Torx screws from front right bottom corner holding tank to base (3).
4. Remove right hinge cover (4a), release right door tension cord from hinge (4b) & remove ground wire (4c).
5. Raise and block up tank as shown with strut onto base (5a), sliding a piece of wood or other solid material between the tank and base to keep tank from falling back onto base (5b).

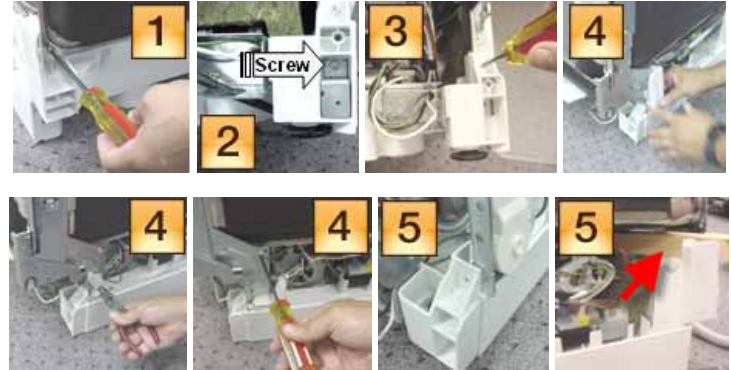

**CAUTION:** Don't turn dishwashers upside-down for tank access without completely removing all water. On pressure-fill dishwashers, water can flow into the water fill assembly diaphragm and cause water to not fill properly.

## 5.2.5 To remove complete Sisme pump

Tools needed: flat blade screwdriver.

1. Disconnect wire harness from motor after carefully noting connections (1).
2. For UC/11 & later models with softer bearing, lift up rubber straps from both sides of motor (2). For older models, lift motor up from base.
3. To release plastic latch on pump/motor housing (@ 2:30 position), carefully push onto latch with screwdriver (3).
4. To release motor from pump housing, twist motor to the right (clockwise). Some force may be required. Capacitor should be ~ 11:00 position (4). Pull motor out from pump housing.

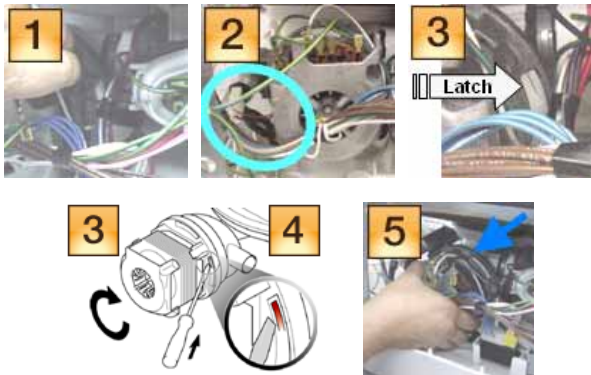

**⚠ CAUTION:** Don't grab motor next to the capacitor to avoid jamming your hand on the capacitor.

## 5.2.6 To install impeller kit # 167085

Tools needed: flat blade screwdriver.

1. While holding motor fan so shaft won't spin (1a), unscrew impeller counterclockwise (1b).
2. Rotate pump housing counterclockwise until tabs clear, then lift housing from motor (2).
3. Remove spring and O-ring from pump housing, then lift spacer up from motor shaft (3).
4. Place replacement spacer onto motor shaft (3). Note larger end goes onto shaft 1st.
5. Install replacement spring & O-ring onto pump housing, then line up housing-motor tabs to screw pump housing onto motor (5a). Screw replacement impeller onto motor shaft (5b).
6. Align motor to pump housing with capacitor @ 11:00 position to facilitate reassembly.

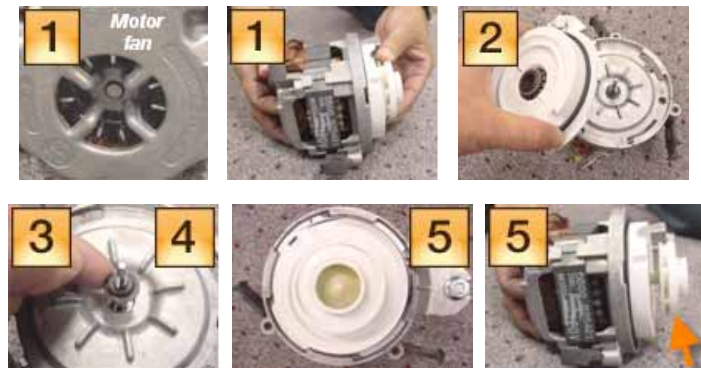

**NOTE:** Use **167085** impeller kit with **266511** motor, **239144** pump and **437345** pump. Don't use with **442548** Sicasym pump.

## 5.3 Controls

### 5.3.1 Fascia panel mounted controls

Controls are easily removed from fascia panels by bending console tabs.

*Tools needed: T-20 Torx & flat blade screwdrivers.*

1. Remove fascia panel by removing T-20 Torx inner door screws.
2. Disconnect wire harnesses from module after noting connector locations.
3. Pry out metal console tabs holding module to console.
4. Carefully pry back plastic tabs, then slide module from console.

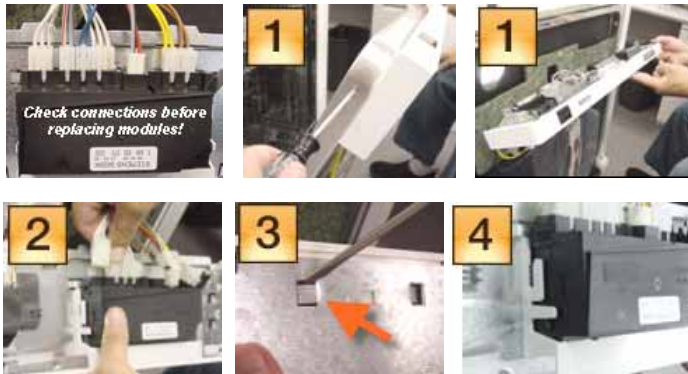

**⚠ CAUTION** – 75% of all controls returned for analysis check out OK. Most control issues are due to loose connections.

### 5.3.2 Base mounted controls

Base mounted controls are located on the base between circulation pumps and heaters, not behind fascia panels. So:

- Dishwashers must be pulled out to change controls.
- Dishwashers must be pulled out to measure voltages & resistances.

#### 5.3.2.1 To access base-mounted controls

*Tools needed: T-20 Torx screwdriver & pliers.*

3. **Remove outer door** – see section 5.2.1.1
4. **Remove toe kick** – see section 5.2.1.2.
5. **Remove right/left side panels** – see section 5.2.1.3.
6. **Raise right side of tank** – see section 5.2.1.4.

#### 5.3.2.2 To remove base-mounted controls

- Locate control, open control cover and disconnect wire harnesses from module after noting connector locations.
- Push latch on back of control toward rear of dishwasher, then slide control from base.





### 5.3.3 Display modules

Some dishwashers have separate 3-digit display modules mounted on the front of fascia panels.

*Tools needed: T-20 Torx & flat blade screwdrivers.*

#### 5.3.3.1 To remove / install display modules

1. **Remove outer door & fascia panel** – see section 5.3.1.
2. Disconnect wire harness and rotate display out from display holder. Confirm latches are intact.
3. To install display, route display wire harness through console opening, push harness onto pushbutton carrier wire guide & connect terminal.
4. Insert display into top latches, then push bottom of display up and rotate it into bottom latches.



## 5.4 Heaters

The heater & NTC can be accessed or measured from the right side of the dishwasher, but can only be removed by dropping the entire base (by flipping the dishwasher on its back) since they are wedged underneath the tank.

### 5.4.1 For access to heaters & NTC's

*Tools needed: T-20 Torx screwdriver & pliers.*

1. **Remove outer door** – see section 5.2.1
2. **Remove toe kick** – see section 5.2.2.
3. **Remove right/left side panels** – see section 5.2.3.
4. **Raise right side of tank** – see section 5.2.4.

### 5.4.2 To separate base from tank

1. Carefully lay dishwasher upside-down.
2. Carefully pull door springs out from base.





- Remove terminal blocks (for two-piece harnesses) or base-mounted controls from base when necessary.



- Remove water valve** -- see section 5.1.1.1.
- Disconnect J-box ground wire and pull wires out of J-box.



- Pull out inlet hose from sump.
- Disconnect front and rear screws holding base and tank.
- Carefully pull base away from tank and sump.



### 5.4.3 To remove heater & NTC

- Loosen pump - heater hose clamp and remove two (2) T-20 Torx screws holding heater assembly to sump.
- Carefully pull heater from sump & pump. The heater comes as an assembly with housing & gasket.



- Note connections, remove NTC cover and disconnect wires from heater, flow switch, NTC & Hi-Limit.
- Push NTC latches and lift NTC from heater.
- To remove flow switch, carefully pry housing away from switch (until tabs clear switch), then snap switch out.

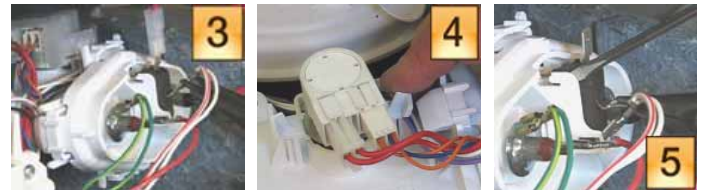

**TIP:** If needed, use rinse-aid to lubricate gaskets to make it easier to assemble heater to sump and pump.



#### 5.4.4 Softer bearing & non-softer bearing heaters

Softer bearing & non-softer bearing heaters are connected to circulation pumps differently:

- Softer bearing models (UC/11 & above) have gasket assembled to heater and use a hose clamp (172272 provided separately).

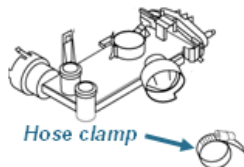

- Older models (UC/06) have a separate gasket and do not have a hose clamp.
- Softer bearing & non-softer bearing heater assemblies, circulation pumps and sumps **cannot** be mixed and matched.

#### 5.5 2-piece drain hose connection

Drain hoses come in two pieces, an external (customer) drain hose and an internal drain hose. The 90° elbow of the external hose is connected to the outlet of the internal hose (pointing toward the drain) and is held in place by a hose clamp.



To remove the internal drain hose, remove a white plastic hose lock and pull the hose from the water level control.

#### 5.6 Drain pump removal and installation

To access pump, disconnect inlet hose and pump harness. To remove pump, (1) pull latch (on circular collar), (2) rotate pump clockwise (cw) ~ 1/8 turn and (3) pull out pump. To install new pump, insert @ 2:00 position & rotate counterclockwise (ccw).

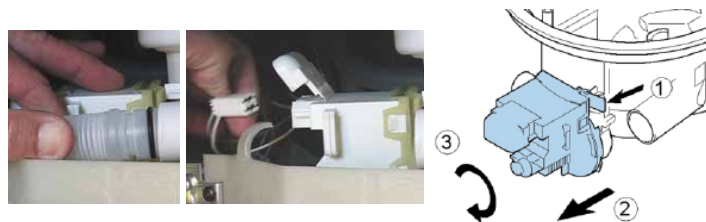

#### 5.7 Door latch removal and installation

Other than occasional misalignment, the only door latch repairs will be replacing microswitches. Older SHU43/53/68 dishwashers used door latches with rods connecting them with on/off switches.

##### 5.7.1 To remove door latches

1. **Remove fascia panel** -- section 5.3.1.
2. Locate door latch in console and bend out console metal tabs to allow latch removal.



3. Remove door latch from console.
4. If door latch has a microswitch cover, disconnect wire harness and remove microswitch & cover.
5. Remove microswitch from door latch.



**HINT:** Make sure plastic latch tabs are aligned & metal console tabs are bent back completely during reassembly.

### 5.7.2 Misaligned door latches

Occasionally integrated dishwasher door latches can be misaligned, causing doors to not close properly or dishwashers to run with doors open (when latches don't reset). Follow these steps to realign door latches.

1. Insert latch tabs into frame.
2. Bend tabs down into latch.
3. Reset latch to open position.



**HINT:** Make sure latch tabs are seated, all fascia frame (console) tabs are bent completely, door strikes are aligned with latches and door latches get reset.



### 5.7.3 Miswired door latches

If replacement **SHV46/66**, **SHU995x**, **SHV68**, **SHX33/43/46**, **SHY56/66** or **SL95A** door latches/wire harnesses are miswired (with door latch terminals backwards), dishwashers run with doors open and lights won't turn on when doors are open. Controls can be irreversibly damaged.

#### 5.7.3.1 Rewiring door latches:

- Check wiring to photos below – the double wire must be connected to the silver door latch terminal.
- With door open, turn on dishwasher – keep door open. If display doesn't turn on, immediately turn off dishwasher and reverse door latch terminal.

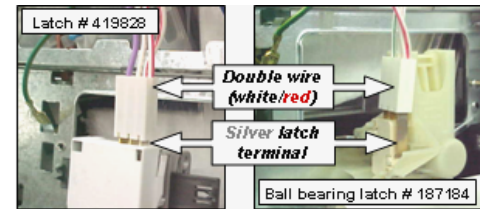

**CAUTION:** Operating dishwashers with miswired door latches will cause irreversible damage to controls if circulation pumps have started – controls must be replaced. Check door latch wiring whenever door latch terminals are disconnected or changed or when displays don't light up.

## 6 FAULT DIAGNOSTICS

### 6.1 Customer service test program

#### 6.1.1 Entering customer service test program

Controls contain codes for factory tests, customer service test program, dishwasher configuration and error codes. Consult test programs and error codes for your dishwasher before using the codes from this manual.

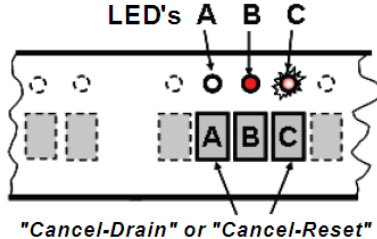

While pushing (and holding) any two wash cycle buttons, turn the dishwasher on with the on/off switch. After releasing the buttons, LED "B" will be lit and LED "C" will flash, confirming you're in the special programs menu.

To enter the test program, push button "B" repeatedly until the digital display shows "P1" or until LED "C" is lit.

Push button "C" to start the program -- LED "C" will blink. The steps will show on the digital display (e.g. "S:01") -- push button "B" to skip a step.

Stored error codes will show on the digital display and LED's (see Error code displays).

The test program can only be stopped / reset by pushing the on/off button – it can't be done by turning off the power.

#### 6.1.2 Error code displays

Error codes can be found using the customer service test program. Most dishwashers will show the following error codes. For dishwashers without digital displays, the "LED's" column will show the light displays for each error code.

LED's	Digital display	Error codes	Priority	Symbols
○ ○ ○	E0	No errors	high ↓ low	☀ = LED flashing ● = LED lit ○ = LED off
○ ○ ☀	E1	Heating error		
○ ○ ●	E2	NTC error		
○ ○ ☀	E3	Filling error		
☀ ○ ○	E4	Water switch error		
☀ ○ ☀	E5	Float water level or motor speed error		
☀ ☀ ○	E6	Aqua sensor error		

If there is more than one error code, the display shows the one with the higher priority.

Dishwasher controls store error codes from the last wash cycle (units w/o digital displays) or from the last eight wash cycles (units w/ digital displays).

Error code **E5** depends on the model, either *safety float water level reached* or *motor speed error*. Check the test program for the particular model.

If error code **E5** is *safety float water level reached*, check the float and float switch, check if water is in the base and check if the water inlet valve has re-seated after closing.

#### 6.1.3 Clearing error codes

To clear error codes, run the customer service test program.

## 6.1.4 Viewing customer service program

Test programs differ from model to model. Consult the test program for your model. The one below is an example of a typical test program.

INDEX	Function	Temperature	Time(s)	Sensor	alternating	UR	LR	Both	Comment
					always on	always on	always on	always on	
0	DP + WSP		30					X	
1	VF			F1				X	
2	MP		5					X	
3	MP + VF			F1				X	
4	WSP			position WS		X			
5	MP + H + Disp + AQS cal.	max. 72°	43			X			
6	MP + H + Disp.	max. 72°	2			X			
7	MP + H	60°			30s / 30s				
8	MP + Disp		120		30s / 30s				
9 to 14	alternating DP / MP		30						
15	DP		45						
16	MP + DP		15						

Push button “**B**” to skip a step.

**DP** = Drain pump

**MP** = Main (circulation) pump

**Disp** = Dispenser

**H** = Heater

**WSP** = Water switch position

**VF** = Water fill (**F1** = water fill switch)

**AQS** = Aqua sensor

**UR** = Upper rack

**LR** = Lower rack

## 6.2 Troubleshooting

### 6.2.1 Heater diagnosing

Test programs heat the water to 150°F at ~ 2°F / minute. To save time, don't run the entire test – when water circulates and the heater is on, measure the incoming current to the dishwasher. If the current is ~ **11A**, the heater is OK. If the current is ~ **1.5 – 2A**, the control or heater could be faulty.

At the control or heater, measure the voltage between the large **red** heater wire and a chassis ground or the dw neutral (WHRD on/off switch or flow switch wire). If the voltage is 120 VAC, the control is OK. If the voltage is 0, the heater relay has failed – replace the control.

To check the heater, turn off the dishwasher, block up the tank and check the resistance of each part of the heater as follows.

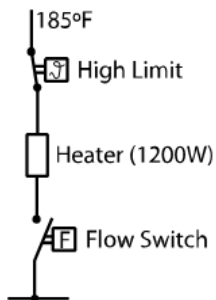

- **Heater ~ 11 Ω**
- **Hi-Limit ~ .3 Ω**
- **Flow switch ~ .4Ω.** A spring loaded plunger closes it when water is flowing, so you must remove the microswitch from the heater and close its contacts to measure the resistance.

**TIP:** Current can be measured through the **red** heater wire at the control or heater (~ **9.5A**). There can be more than one red wire, so check the wiring diagram to select the heater wire.

**NOTE:** Open door to run test program for fully-integrated models.

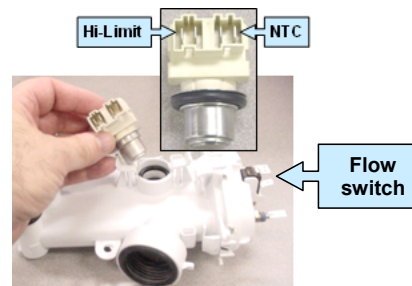

### 6.2.2 Controls timing out and showing “1”

Occasionally dishwashers can run for hours, not finish washing & show a “1” in the display. This means the module has timed out due to an unidentified heating problem -- all heating related parts must be checked until the problem is found.

#### ***Heating system checklist if controls time out:***

- Check control module heater relay & solder joints.
- Check wire harness & terminals (to control and heater). Controls have been replaced when the problem was loose connections.
- Check heater resistance (~ 11Ω).
- Check flow switch (~ 0.4Ω). If flow switch is OK & water doesn't flow, check circulation pump.
- Check NTC (~ 55kΩ @72°F) and Hi-Limit. See NTC resistance chart (section 6.3.3).

**IMPORTANT:** Whenever a “1” shows in the control display, reset the control after fixing the heating problem by running the dishwasher. The module resets after the 1st run.

### 6.2.3 NTC resistance chart

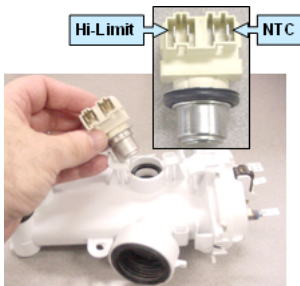
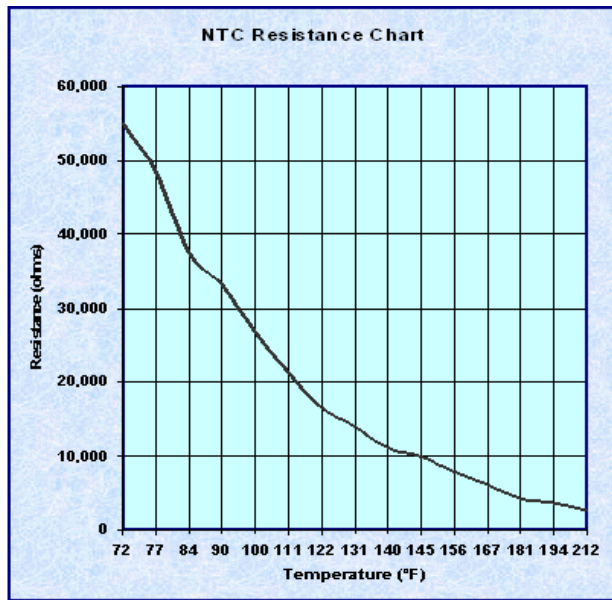

Where to  
measure NTC  
resistances

### 6.2.4 Water Leaking Past Doors

Water seldom leaks out of bottom of dishwasher doors. Usually it's a customer or installation issue. Occasionally air pockets (from standing water in loops) or kinks in condensation tubes block condensation tubes and cause leaking. Pressure builds in tanks, blowing water past lower door seals (usually at start of cycles). Draining condensation tubes and straightening out kinks solves these occasional problems.

#### **Checklist if water leaks past doors:**

- Make sure condensation tubes are inserted into bases, not connected to drains or air gaps.
- Clear and drain condensation tubes, including debris in bases.
- Re-drill wood doors to make them square.
- Straighten kinks in condensation tubes.
- Educate customer on oversudsing (from too much detergent/rinse-aid or overly soft water).
- Level dishwasher before attaching under-counter brackets.
- Replace damaged door seals, including replacements cut too short.
- Refill lower racks overfilled with dishes.
- Move flexible cutting boards to left side of dishwasher.

## 6.2.5 Cosmetic / Customer Use / Installation Issues

1. **Control codes during Cancel-Drain** -- Customers have pushed / held *Cancel-Drain* or *Cancel-Reset* buttons while turning dw's on and entered control coding selection or customer service test programs showing codes such as *E0*, *P0*, *P1*, *C1*, *P2*, etc.
2. **Not cleaning or locking sump filters.**
3. **Smelly dishwashers** -- Often occurs from filters not being cleaned, drain hose high loops missing or drain gases being present. If all else is OK, then problem can be preservative not purged from tank door gasket.
4. **Doors leaking or not latching** -- Usually an installation issue (dishwasher brackets installed before dishwashers are leveled front to back, tanks & doors out of square, wooden doors not drilled accurately). Can be blockage in condensation tubes or condensation tubes connected to drain hose air gaps.
5. **Inner door damage** -- From upper rack during improper shipping and handling (dishwashers clamped on wrong sides or dropped).
6. **Doors hit toe kicks** -- Toe kick installation issue.
7. **Junction boxes** -- Comes from wires not being connected correctly during installation.
8. **Dispensers** -- Customers using too much detergent, not using rinse-aid & not knowing how to close the door.
9. **Drain hoses not installed properly** -- Often no air gap or high loop + pinched hoses -- causes poor draining & smelly dishwashers. Most drain pumps are mistakenly replaced for drain hose installation issues.
10. **Outer doors** -- Most are dinged during shipment.
11. **Damaged water valves** -- Primarily from fittings being overtightened. A damaged valve can allow some water onto kitchen floors.

## 6.2.6 Customer self-help diagnosing

Dishwashers may occasionally exhibit problems unrelated to a dishwasher failure. The following fixes can be made by customers without calling for repair.

1. **Dishes do not dry** -- The rinse agent dispenser may be empty. Check the rinse-aid dispenser and refill it if necessary. Dishware drying can be accelerated and enhanced by opening the dishwasher door slightly and propping it open with the top rack.
2. **Indicator light(s) do not come on** -- A fuse may have blown or a circuit breaker tripped. Check the fuse or circuit breaker at your fuse box/breaker box and replace the fuse or reset the breaker if necessary.
3. **Dishwasher does not start** -- The dishwasher door may not be properly shut. Make certain the dishwasher door is shut and latched.
4. **Dishwasher runs a long time** -- If the dishwasher completes the cycle, but the run time seems exceptionally long, it may be due to cold incoming water. Before starting the dishwasher, open the hot water faucet at the sink nearest the dishwasher. Run the water until it runs hot, then turn off the water and start the dishwasher.
5. **Machine cycle does not advance to rinse** -- The water supply line may be shut off. Check the water supply valve and open it if it's shut.
6. **White spots left on dishes** -- More rinse agent is needed.
7. **Water not pumped from dishwasher** --
  - a. Make certain the drain hose isn't kinked, clogged, or improperly installed. Make sure the drain hose is at least 20 inches above the floor.
  - b. Make certain the dishwasher filter system and kitchen sink drain aren't clogged. You may need a plumber



---

rather than a serviceman for the dishwasher. If an air gap is installed at sink, it may be clogged.

8. **Detergent dispenser cover will not shut** – The cover may not have been shut correctly or a cycle was not finished and should've been cancelled.
9. **Streaks on glassware** -- Too much rinse agent is being dispensed.
10. **Rattling noises** -- Utensils may not be properly arranged.
11. **Suds in dishwasher** – The customer may have used the wrong type of dishwashing detergent. Use only automatic dishwasher detergents.
12. **Unsatisfactory washing results**
  - a. Incorrect amount of detergent.
  - b. Utensils incorrectly arranged or rack overloaded.
  - c. Spray arm rotation blocked by utensils.
  - d. Spray arm nozzles need cleaning.
  - e. Filters not properly fitted into position.
  - f. Unsuitable cycle selected.

---

## 7 TECHNICAL SPECIFICATIONS

---

- **Dishwasher ratings** – Dishwashers are rated 120VAC, 60 Hz, 15A, 1450W (max.). Maximum amp draw when heaters running ~ 11A.
- **Heater ratings** – 120VAC, 1200W, flow-through, heats water ~ 2°F / minute.
- **Noise level** – Dependent on model, from 44 db – 56 dB.
- **Circulation pump ratings (Sicasym motor)** – 120VAC, 60 Hz, 120W (~ .16 HP), insulation class A, with auto-reset thermal protector, 35µF capacitor.
- **Circulation pump ratings (two-winding motor)** – 120VAC, 60 Hz, 160W (~ .21 HP), insulation class A, with auto-reset thermal protector, 10µF capacitor.
- **Drain pump ratings** – 110 - 127 VAC, 60 Hz, 35W, .84A, 17Ω, 9-vane (4-vane & older 6-vane pump have same ratings).
- **Water inlet pressure range** – From 5 – 120 psi (.3 – 8.27 bar).
- **Circulation pump flow rate** – Approximately 60 liters/minute (~ 15.85 gallons/minute) at a pressure of 420 mbar (6.1 psi).
- **Drain pump flow rate** – Approximately 10 liters/minute (~ 2.64 gallons/minute) at a delivery height (head) of .9m (2.95').
- **Water inlet valve flow rate** – Approximately 2 liters/minute (~ .5 gallons/minute).