

## FEATURES

- **Low Start-Up Current (<0.5 mA)**
- **Trimmed Oscillator Discharge Current**
- **Current Mode Operation to 500 kHz**
- **Automatic Feed-Forward Compensation**
- **Latching PWM for Cycle-by-Cycle Current Limiting**
- **Internally Trimmed Reference With Undervoltage Lockout**
- **High-Current Totem-Pole Output Undervoltage Lockout With Hysteresis**
- **Double-Pulse Suppression**

**D (SOIC) OR P (PDIP) PACKAGE  
(TOP VIEW)**

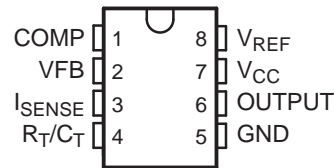

**D (SOIC) PACKAGE  
(TOP VIEW)**

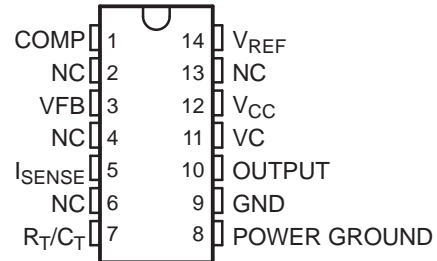

NC – No internal connection

## DESCRIPTION/ORDERING INFORMATION

The TL284xB and TL384xB series of control integrated circuits provide the features that are necessary to implement off-line or dc-to-dc fixed-frequency current-mode control schemes, with a minimum number of external components. Internally implemented circuits include an undervoltage lockout (UVLO) and a precision reference that is trimmed for accuracy at the error amplifier input. Other internal circuits include logic to ensure latched operation, a pulse-width modulation (PWM) comparator that also provides current-limit control, and a totem-pole output stage designed to source or sink high-peak current. The output stage, suitable for driving N-channel MOSFETs, is low when it is in the off state.

The TL284xB and TL384xB series are pin compatible with the standard TL284x and TL384x with the following improvements. The start-up current is specified to be 0.5 mA (max), while the oscillator discharge current is trimmed to 8.3 mA (typ). In addition, during undervoltage lockout conditions, the output has a maximum saturation voltage of 1.2 V while sinking 10 mA ( $V_{CC} = 5$  V).

Major differences between members of these series are the UVLO thresholds and maximum duty-cycle ranges. Typical UVLO thresholds of 16 V (on) and 10 V (off) on the TLx842B and TLx844B devices make them ideally suited to off-line applications. The corresponding typical thresholds for the TLx843B and TLx845B devices are 8.4 V (on) and 7.6 V (off). The TLx842B and TLx843B devices can operate to duty cycles approaching 100%. A duty-cycle range of 0% to 50% is obtained by the TLx844B and TLx845B by the addition of an internal toggle flip-flop, which blanks the output off every other clock cycle. The TL284xB-series devices are characterized for operation from  $-40^{\circ}\text{C}$  to  $85^{\circ}\text{C}$ . The TL384xB-series devices are characterized for operation from  $0^{\circ}\text{C}$  to  $70^{\circ}\text{C}$ .



Please be aware that an important notice concerning availability, standard warranty, and use in critical applications of Texas Instruments semiconductor products and disclaimers thereto appears at the end of this data sheet.

# TL284xB, TL384xB HIGH-PERFORMANCE CURRENT-MODE PWM CONTROLLERS

SLVS610B – AUGUST 2006 – REVISED JULY 2007

## ORDERING INFORMATION

T <sub>A</sub>	PACKAGE <sup>(1)</sup>		ORDERABLE PART NUMBER	TOP-SIDE MARKING
-40°C to 85°C	PDIP – P	Tube of 50	TL2842BP	TL2842BP
			TL2843BP	TL2843BP
			TL2844BP	TL2844BP
			TL2845BP	TL2845BP
	SOIC – D (8 pin)	Tube of 75	TL2842BD-8	2842B
			TL2842BDR-8	
		Reel of 2500	TL2843BD-8	2843B
			TL2843BDR-8	
		Tube of 75	TL2844BD-8	2844B
			TL2844BDR-8	
		Reel of 2500	TL2845BD-8	2845B
			TL2845BDR-8	
	SOIC – D (14 pin)	Tube of 75	TL2842BD	TL2842B
			TL2842BDR	
		Reel of 2500	TL2843BD	TL2843B
			TL2843BDR	
Tube of 75		TL2844BD	TL2844B	
		TL2844BDR		
Reel of 2500		TL2845BD	TL2845B	
		TL2845BDR		
0°C to 70°C	PDIP – P	Tube of 50	TL3842BP	TL3842BP
			TL3843BP	TL3843BP
			TL3844BP	TL3844BP
			TL3845BP	TL3845BP
	SOIC – D (8 pin)	Tube of 75	TL3842BD-8	3842B
			TL3842BDR-8	
		Reel of 2500	TL3843BD-8	3843B
			TL3843BDR-8	
		Tube of 75	TL3844BD-8	3844B
			TL3844BDR-8	
		Reel of 2500	TL3845BD-8	3845B
			TL3845BDR-8	
	SOIC – D (14 pin)	Tube of 75	TL3842BD	TL3842B
			TL3842BDR	
		Reel of 2500	TL3843BD	TL3843B
			TL3843BDR	
Tube of 75		TL3844BD	TL3844B	
		TL3844BDR		
Reel of 2500		TL3845BD	TL3845B	
		TL3845BDR		

(1) Package drawings, standard packing quantities, thermal data, symbolization, and PCB design guidelines are available at [www.ti.com/sc/package](http://www.ti.com/sc/package).

**FUNCTIONAL BLOCK DIAGRAM**

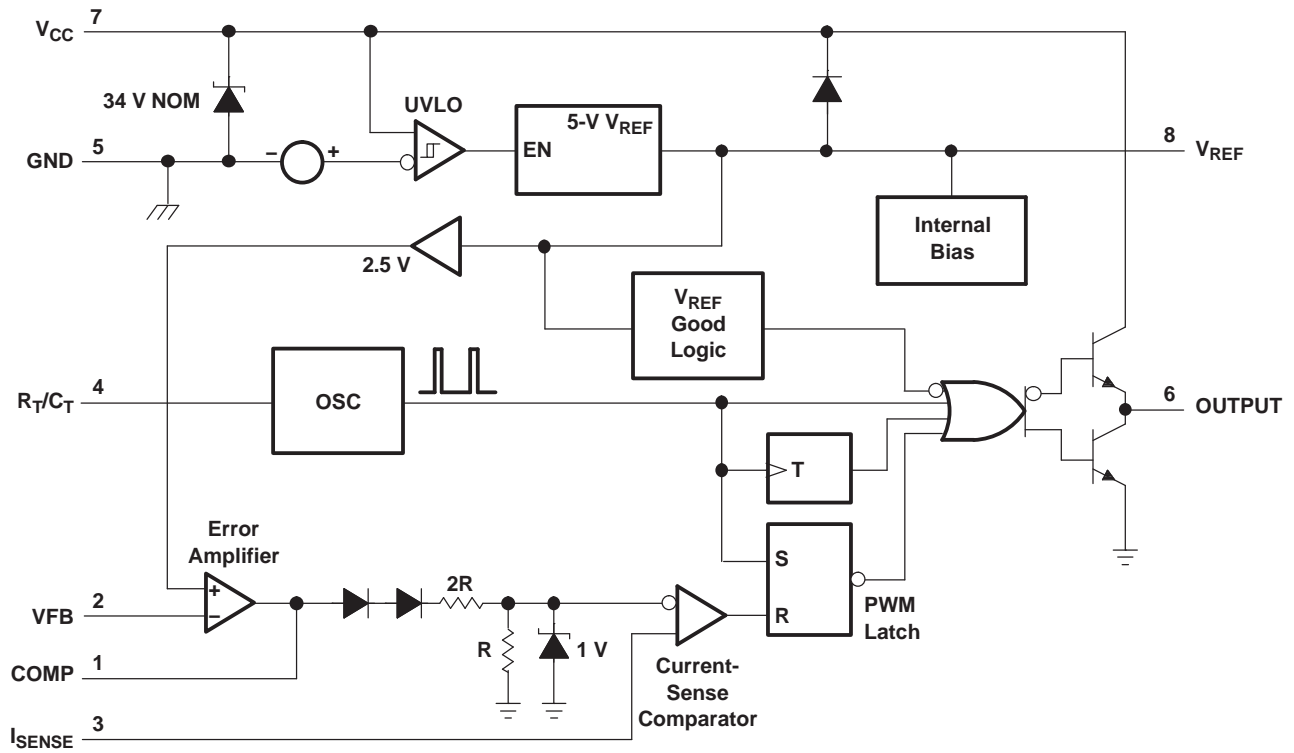

A. Pin numbers shown are for the 8-pin D package.

# TL284xB, TL384xB HIGH-PERFORMANCE CURRENT-MODE PWM CONTROLLERS

SLVS610B – AUGUST 2006 – REVISED JULY 2007

## Absolute Maximum Ratings<sup>(1)(2)</sup>

over operating free-air temperature range (unless otherwise noted)

		MIN	MAX	UNIT	
V <sub>CC</sub>	Supply voltage	Low impedance source	30	V	
		I <sub>CC</sub> < 30 mA	Self limiting		
V <sub>I</sub>	Analog input voltage range	VFB and I <sub>SENSE</sub>	-0.3	6.3	V
I <sub>CC</sub>	Supply current		30	mA	
I <sub>O</sub>	Output current		±1	A	
I <sub>O(sink)</sub>	Error amplifier output sink current		10	mA	
θ <sub>JA</sub>	Package thermal impedance <sup>(3)(4)</sup>	D package	8 pin	97	°C/W
			14 pin	86	
		P package	85		
	Output energy	Capacitive load	5	μJ	
T <sub>J</sub>	Virtual junction temperature		150	°C	
T <sub>stg</sub>	Storage temperature range		-65	150	°C
T <sub>lead</sub>	Lead temperature	Soldering, 10 s	300	°C	

- (1) Stresses beyond those listed under "absolute maximum ratings" may cause permanent damage to the device. These are stress ratings only, and functional operation of the device at these or any other conditions beyond those indicated under "recommended operating conditions" is not implied. Exposure to absolute-maximum-rated conditions for extended periods may affect device reliability.
- (2) All voltages are with respect to the device GND terminal.
- (3) Maximum power dissipation is a function of T<sub>J(max)</sub>, θ<sub>JA</sub>, and T<sub>A</sub>. The maximum allowable power dissipation at any allowable ambient temperature is P<sub>D</sub> = (T<sub>J(max)</sub> - T<sub>A</sub>)/θ<sub>JA</sub>. Operating at the absolute maximum T<sub>J</sub> of 150°C can impact reliability.
- (4) The package thermal impedance is calculated in accordance with JESD 51-7.

## Recommended Operating Conditions

		MIN	NOM	MAX	UNIT
V <sub>CC</sub>	Supply voltage	V <sub>CC</sub>		30	V
		VC <sup>(1)</sup>		30	
V <sub>I</sub>	Input voltage	R <sub>T</sub> /C <sub>T</sub>	0	5.5	V
		VFB and I <sub>SENSE</sub>	0	5.5	
V <sub>O</sub>	Output voltage	OUTPUT	0	30	V
		POWER GROUND <sup>(1)</sup>	-0.1	1	
I <sub>CC</sub>	Supply current, externally limited			25	mA
I <sub>O</sub>	Average output current			200	mA
I <sub>O(ref)</sub>	Reference output current			-20	mA
f <sub>osc</sub>	Oscillator frequency		100	500	kHz
T <sub>J</sub>	Operating free-air temperature	TL284xB	-40	85	°C
		TL384xB	0	70	

- (1) The recommended voltages for VC and POWER GROUND apply only to the 14-pin D package.

**Reference Section Electrical Characteristics**
 $V_{CC} = 15\text{ V}^{(1)}$ ,  $R_T = 10\text{ k}\Omega$ ,  $C_T = 3.3\text{ nF}$ , over recommended operating free-air temperature range (unless otherwise specified)

PARAMETER	TEST CONDITIONS	TL284xB			TL384xB			UNIT
		MIN	TYP <sup>(2)</sup>	MAX	MIN	TYP <sup>(2)</sup>	MAX	
Output voltage	$I_O = 1\text{ mA}$ , $T_J = 25^\circ\text{C}$	4.95	5	5.05	4.9	5	5.1	V
Line regulation	$V_{CC} = 12\text{ V}$ to $25\text{ V}$		6	20		6	20	mV
Load regulation	$I_O = 1\text{ mA}$ to $20\text{ mA}$		6	25		6	25	mV
Average temperature coefficient of output voltage			0.2	0.4		0.2	0.4	mV/ $^\circ\text{C}$
Output voltage, worst-case variation	$V_{CC} = 12\text{ V}$ to $25\text{ V}$ , $I_O = 1\text{ mA}$ to $20\text{ mA}$	4.9		5.1	4.82		5.18	V
Output noise voltage	$f = 10\text{ Hz}$ to $10\text{ kHz}$ , $T_J = 25^\circ\text{C}$		50			50		$\mu\text{V}$
Output-voltage long-term drift	After 1000 h at $T_J = 25^\circ\text{C}$		5	25		5	25	mV
Short-circuit output current		-30	-100	-180	-30	-100	-180	mA

 (1) Adjust  $V_{CC}$  above the start threshold before setting it to 15 V.

 (2) All typical values are at  $T_J = 25^\circ\text{C}$ .

**Oscillator Section<sup>(1)</sup> Electrical Characteristics**
 $V_{CC} = 15\text{ V}^{(2)}$ ,  $R_T = 10\text{ k}\Omega$ ,  $C_T = 3.3\text{ nF}$ , over recommended operating free-air temperature range (unless otherwise specified)

PARAMETER	TEST CONDITIONS	TL284xB			TL384xB			UNIT
		MIN	TYP <sup>(3)</sup>	MAX	MIN	TYP <sup>(3)</sup>	MAX	
Initial accuracy	$T_J = 25^\circ\text{C}$	49	52	55	49	52	55	kHz
	$T_A = T_{low}$ to $T_{high}$		48	56		48	56	
	$T_J = 25^\circ\text{C}$ , $R_T = 6.2\text{ k}\Omega$ , $C_T = 1\text{ nF}$	225	250	275	225	250	275	
Voltage stability	$V_{CC} = 12\text{ V}$ to $25\text{ V}$		0.2	1		0.2	1	%
Temperature stability			5			5		%
Amplitude	Peak to peak		1.7			1.7		V
Discharge current	$T_J = 25^\circ\text{C}$ , $R_T/C_T = 2\text{ V}$	7.8	8.3	8.8	7.8	8.3	8.8	mA
	$R_T/C_T = 2\text{ V}$		7.5	8.8		7.6	8.8	

(1) Output frequency equals oscillator frequency for the TL3842B and TL3843B. Output frequency is one-half the oscillator frequency for the TL3844B and TL3845B.

 (2) Adjust  $V_{CC}$  above the start threshold before setting it to 15 V.

 (3) All typical values are at  $T_J = 25^\circ\text{C}$ .

### Error-Amplifier Section Electrical Characteristics

$V_{CC} = 15\text{ V}^{(1)}$ ,  $R_T = 10\text{ k}\Omega$ ,  $C_T = 3.3\text{ nF}$ , over recommended operating free-air temperature range (unless otherwise specified)

PARAMETER	TEST CONDITIONS	TL284xB			TL384xB			UNIT
		MIN	TYP <sup>(2)</sup>	MAX	MIN	TYP <sup>(2)</sup>	MAX	
Feedback input voltage	COMP = 2.5 V	2.45	2.5	2.55	2.42	2.5	2.58	V
Input bias current			-0.3	-1		-0.3	-2	$\mu\text{A}$
Open-loop voltage amplification	$V_O = 2\text{ V to }4\text{ V}$	65	90		65	90		dB
Gain-bandwidth product		0.7	1		0.7	1		MHz
Supply-voltage rejection ratio	$V_{CC} = 12\text{ V to }25\text{ V}$	60	70		60	70		dB
Output sink current	VFB = 2.7 V, COMP = 1.1 V	2	6		2	6		mA
Output source current	VFB = 2.3 V, COMP = 5 V	-0.5	-0.8		-0.5	-0.8		mA
High-level output voltage	VFB = 2.3 V, $R_L = 15\text{ k}\Omega$ to GND	5	6		5	6		V
Low-level output voltage	VFB = 2.7 V, $R_L = 15\text{ k}\Omega$ to GND		0.7	1.1		0.7	1.1	V

(1) Adjust  $V_{CC}$  above the start threshold before setting it to 15 V.

(2) All typical values are at  $T_J = 25^\circ\text{C}$ .

### Current-Sense Section Electrical Characteristics

$V_{CC} = 15\text{ V}^{(1)}$ ,  $R_T = 10\text{ k}\Omega$ ,  $C_T = 3.3\text{ nF}$ , over recommended operating free-air temperature range (unless otherwise specified)

PARAMETER	TEST CONDITIONS	TL284xB			TL384xB			UNIT
		MIN	TYP <sup>(2)</sup>	MAX	MIN	TYP <sup>(2)</sup>	MAX	
Voltage amplification <sup>(3)(4)</sup>		2.85	3	3.15	2.85	3	3.15	V/V
Current-sense comparator threshold <sup>(3)</sup>	COMP = 5 V	0.9	1	1.1	0.9	1	1.1	V
Supply-voltage rejection ratio <sup>(3)</sup>	$V_{CC} = 12\text{ V to }25\text{ V}$		70			70		dB
Input bias current			-2	-10		-2	-10	$\mu\text{A}$
Delay time to output	VFB = 0 V to 2 V		150	300		150	300	ns

(1) Adjust  $V_{CC}$  above the start threshold before setting it to 15 V.

(2) All typical values are at  $T_J = 25^\circ\text{C}$ .

(3) Measured at the trip point of the latch, with VFB at 0 V.

(4) Measured between  $I_{SENSE}$  and COMP, with the input changing from 0 V to 0.8 V.

### Output Section Electrical Characteristics

 $V_{CC} = 15\text{ V}^{(1)}$ ,  $R_T = 10\text{ k}\Omega$ ,  $C_T = 3.3\text{ nF}$ , over recommended operating free-air temperature range (unless otherwise specified)

PARAMETER	TEST CONDITIONS	TL284xB			TL384xB			UNIT
		MIN	TYP <sup>(2)</sup>	MAX	MIN	TYP <sup>(2)</sup>	MAX	
High-level output voltage	$I_{OH} = -20\text{ mA}$	13	13.5		13	13.5		V
	$I_{OH} = -200\text{ mA}$	12	13.5		12	13.5		
Low-level output voltage	$I_{OL} = 20\text{ mA}$		0.1	0.4		0.1	0.4	V
	$I_{OL} = 200\text{ mA}$		1.5	2.2		1.5	2.2	
Rise time	$C_L = 1\text{ nF}$ , $T_J = 25^\circ\text{C}$		50	150		50	150	ns
Fall time	$C_L = 1\text{ nF}$ , $T_J = 25^\circ\text{C}$		50	150		50	150	ns
UVLO saturation	$V_{CC} = 5\text{ V}$ , $I_{OL} = 1\text{ mA}$		0.7	1.2		0.7	1.2	V

- (1) Adjust  $V_{CC}$  above the start threshold before setting it to 15 V.  
 (2) All typical values are at  $T_J = 25^\circ\text{C}$ .

### Undervoltage-Lockout Section Electrical Characteristics

 $V_{CC} = 15\text{ V}^{(1)}$ ,  $R_T = 10\text{ k}\Omega$ ,  $C_T = 3.3\text{ nF}$ , over recommended operating free-air temperature range (unless otherwise specified)

PARAMETER	TEST CONDITIONS	TL284xB			TL384xB			UNIT
		MIN	TYP <sup>(2)</sup>	MAX	MIN	TYP <sup>(2)</sup>	MAX	
Start threshold voltage	TLx842B, TLx844B	15	16	17	14.5	16	17.5	V
	TLx843B, TLx845B	7.8	8.4	9	7.8	8.4	9	
Minimum operating voltage after start-up	TLx842B, TLx844B	9	10	11	8.5	10	11.5	V
	TLx843B, TLx845B	7	7.6	8.2	7	7.6	8.2	

- (1) Adjust  $V_{CC}$  above the start threshold before setting it to 15 V.  
 (2) All typical values are at  $T_J = 25^\circ\text{C}$ .

### Pulse-Width Modulator Section Electrical Characteristics

 $V_{CC} = 15\text{ V}^{(1)}$ ,  $R_T = 10\text{ k}\Omega$ ,  $C_T = 3.3\text{ nF}$ , over recommended operating free-air temperature range (unless otherwise specified)

PARAMETER	TEST CONDITIONS	TL284xB			TL384xB			UNIT
		MIN	TYP <sup>(2)</sup>	MAX	MIN	TYP <sup>(2)</sup>	MAX	
Maximum duty cycle	TL3842B, TL3843B	94	96	100	94	96	100	%
	TL3844B, TL3845B	47	48	50	47	48	50	
Minimum duty cycle				0			0	%

- (1) Adjust  $V_{CC}$  above the start threshold before setting it to 15 V.  
 (2) All typical values are at  $T_J = 25^\circ\text{C}$ .

### Supply Voltage Electrical Characteristics

 $V_{CC} = 15\text{ V}^{(1)}$ ,  $R_T = 10\text{ k}\Omega$ ,  $C_T = 3.3\text{ nF}$ , over recommended operating free-air temperature range (unless otherwise specified)

PARAMETER	TEST CONDITIONS	TL284xB			TL384xB			UNIT
		MIN	TYP <sup>(2)</sup>	MAX	MIN	TYP <sup>(2)</sup>	MAX	
Start-up current			0.3	0.5		0.3	0.5	mA
Operating supply current	VFB and $I_{SENSE}$ at 0 V		11	17		11	17	mA
Limiting voltage	$I_{CC} = 25\text{ mA}$		30	34		30	34	V

- (1) Adjust  $V_{CC}$  above the start threshold before setting it to 15 V.  
 (2) All typical values are at  $T_J = 25^\circ\text{C}$ .

TYPICAL CHARACTERISTICS

SUPPLY CURRENT  
 VS  
 SUPPLY VOLTAGE

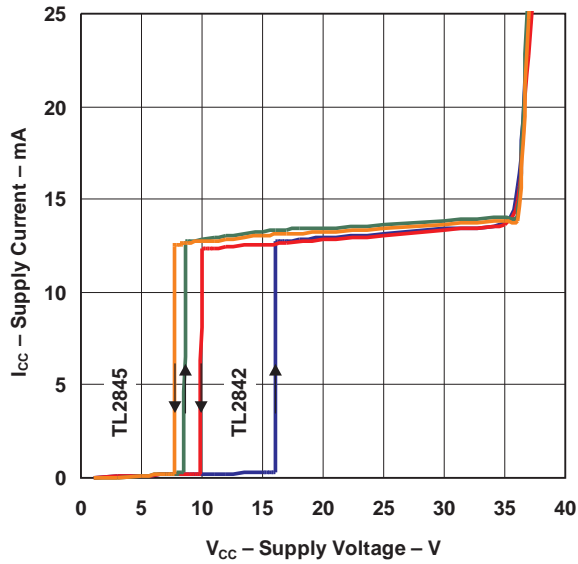

ERROR AMPLIFIER OPEN-LOOP  
 GAIN AND PHASE  
 VS  
 FREQUENCY

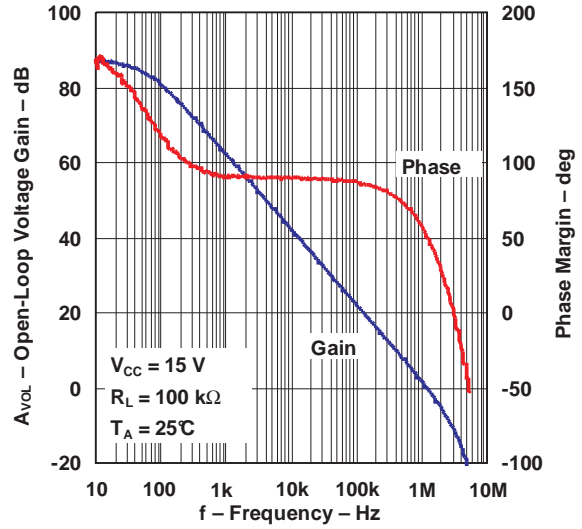

CURRENT-SENSE INPUT THRESHOLD  
 VS  
 ERROR AMPLIFIER OUTPUT VOLTAGE

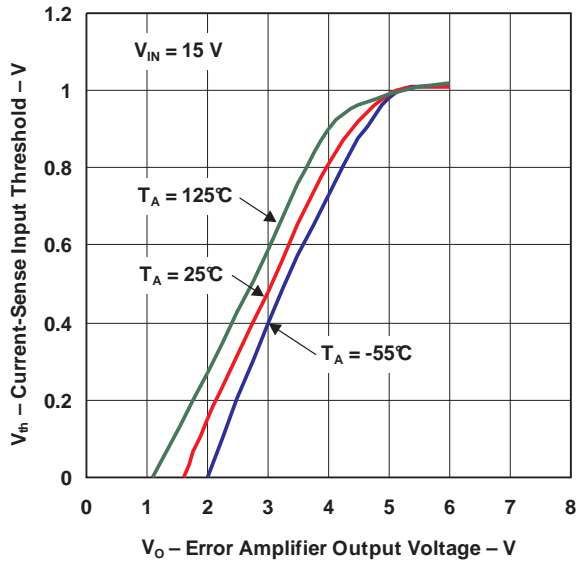

OSCILLATOR DISCHARGE CURRENT  
 VS  
 TEMPERATURE

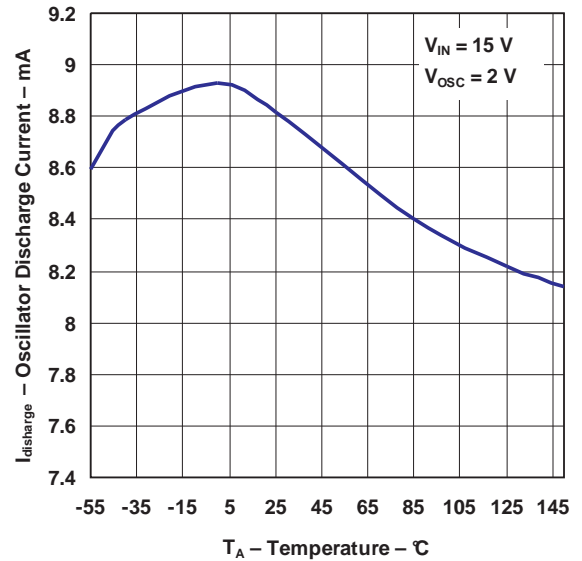



TYPICAL CHARACTERISTICS (continued)

REFERENCE VOLTAGE  
VS  
SOURCE CURRENT



REFERENCE VOLTAGE  
VS  
TEMPERATURE



REFERENCE SHORT-CIRCUIT CURRENT  
VS  
TEMPERATURE

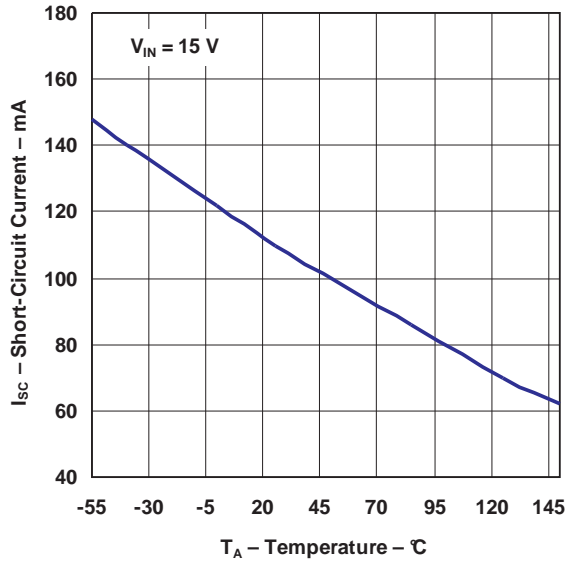

OUTPUT SATURATION VOLTAGE  
VS  
LOAD CURRENT

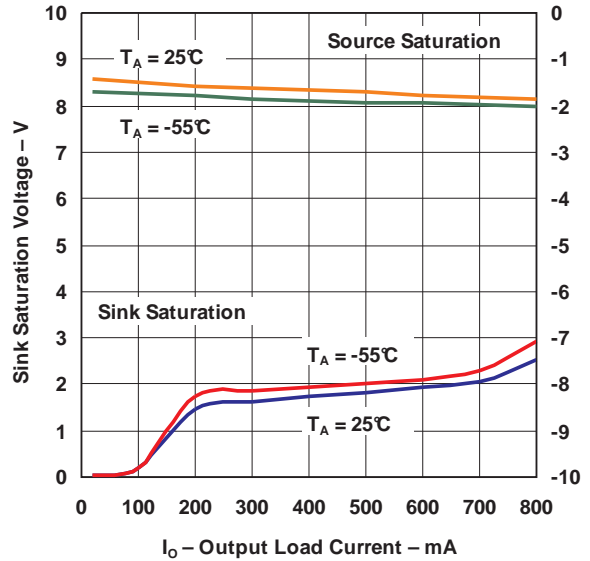

TYPICAL CHARACTERISTICS (continued)

MAXIMUM OUTPUT DUTY CYCLE  
 VS  
 TIMING RESISTOR

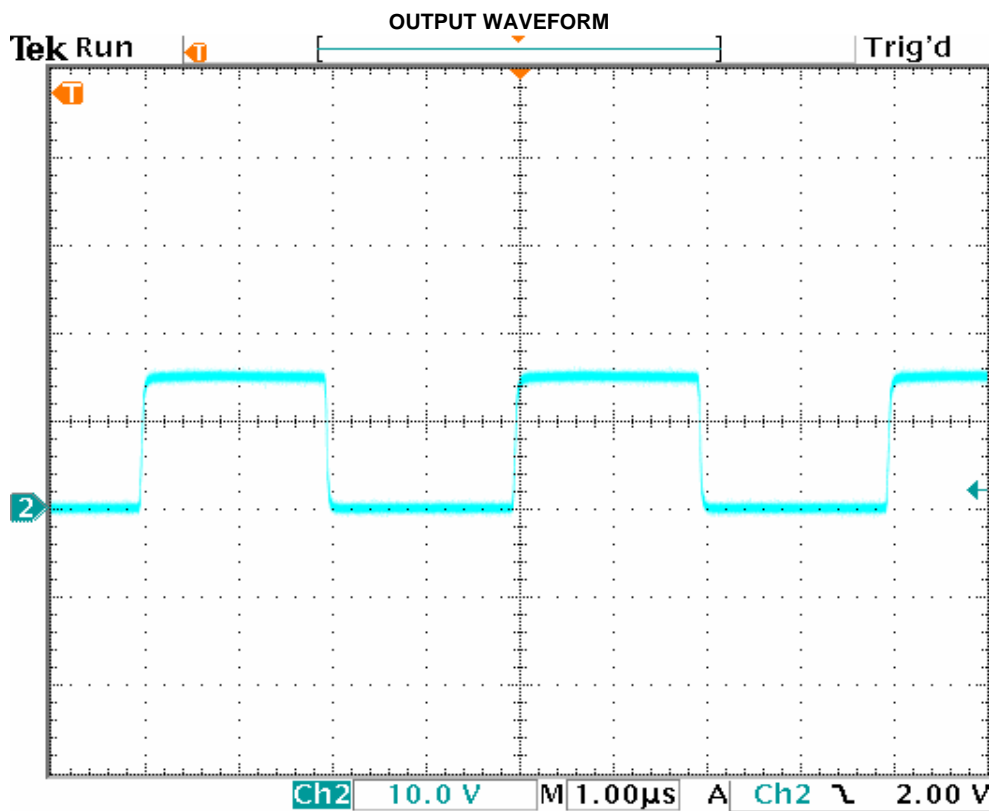

APPLICATION INFORMATION

The error-amplifier configuration circuit is shown in Figure 1.



- A. Error amplifier can source or sink up to 0.5 mA.

Figure 1. Error-Amplifier Configuration

The current-sense circuit is shown in Figure 2.



- A. Peak current ( $I_S$ ) is determined by the formula:  $I_{S(max)} = 1 V/R_S$
- B. A small RC filter formed by resistor  $R_f$  and capacitor  $C_f$  may be required to suppress switch transients.

Figure 2. Current-Sense Circuit

The oscillator frequency is set using the circuit shown in Figure 3. The frequency is calculated as:

$$f = 1 / R_T C_T$$

For  $R_T > 5 \text{ k}\Omega$ :

$$f \approx 1.72 / R_T C_T$$

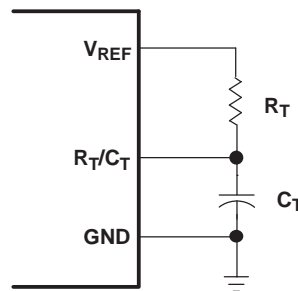
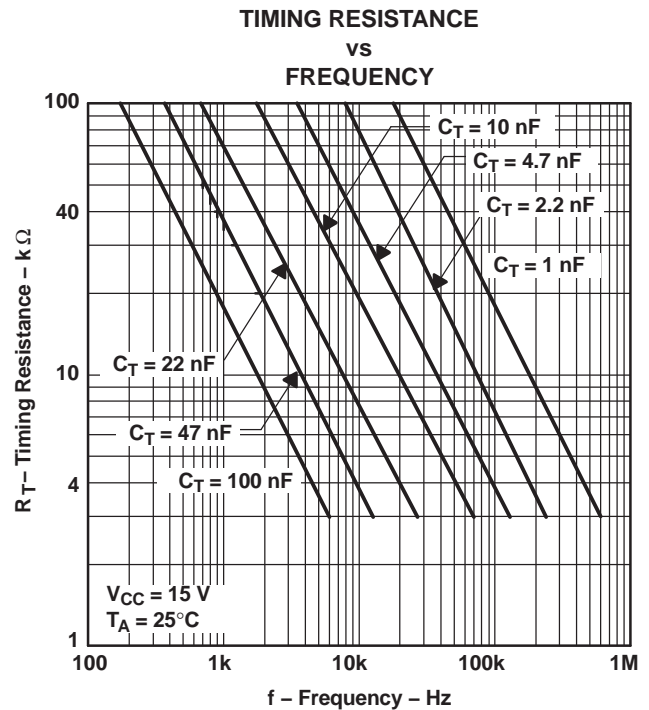
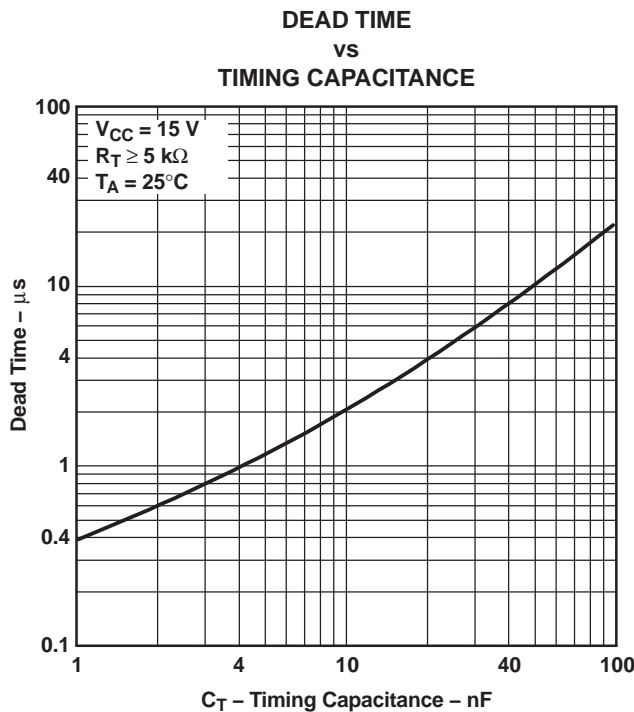

Figure 3. Oscillator Section

APPLICATION INFORMATION (continued)



**Open-Loop Laboratory Test Fixture**

In the open-loop laboratory test fixture (see Figure 4), high peak currents associated with loads necessitate careful grounding techniques. Timing and bypass capacitors should be connected close to the GND terminal in a single-point ground. The transistor and 5-k $\Omega$  potentiometer sample the oscillator waveform and apply an adjustable ramp to the I<sub>SENSE</sub> terminal.



Figure 4. Open-Loop Laboratory Test Fixture

APPLICATION INFORMATION (continued)

Shutdown Technique

The PWM controller (see Figure 5) can be shut down by two methods: either raise the voltage at  $I_{SENSE}$  above 1 V or pull the COMP terminal below a voltage two diode drops above ground. Either method causes the output of the PWM comparator to be high (refer to block diagram). The PWM latch is reset dominant so that the output remains low until the next clock cycle after the shutdown condition at the COMP or  $I_{SENSE}$  terminal is removed. In one example, an externally latched shutdown can be accomplished by adding an SCR that resets by cycling  $V_{CC}$  below the lower UVLO threshold. At this point, the reference turns off, allowing the SCR to reset.

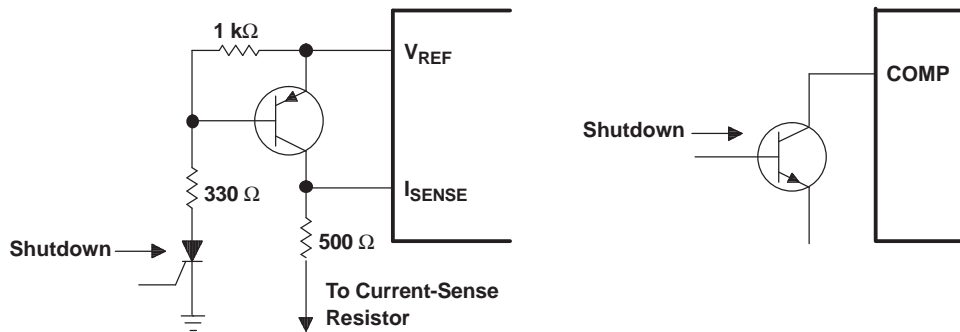

Figure 5. Shutdown Techniques

A fraction of the oscillator ramp can be summed resistively with the current-sense signal to provide slope compensation for converters requiring duty cycles over 50% (see Figure 6). Note that capacitor C forms a filter with R2 to suppress the leading-edge switch spikes.



Figure 6. Slope Compensation

**PACKAGING INFORMATION**

Orderable Device	Status (1)	Package Type	Package Drawing	Pins	Package Qty	Eco Plan (2)	Lead/Ball Finish (6)	MSL Peak Temp (3)	Op Temp (°C)	Device Marking (4/5)	Samples
TL2842BD	ACTIVE	SOIC	D	14	50	Green (RoHS & no Sb/Br)	CU NIPDAU	Level-1-260C-UNLIM	-40 to 85	TL2842B	<a href="#">Samples</a>
TL2842BD-8	ACTIVE	SOIC	D	8	75	Green (RoHS & no Sb/Br)	CU NIPDAU	Level-1-260C-UNLIM	-40 to 85	2842B	<a href="#">Samples</a>
TL2842BDR	ACTIVE	SOIC	D	14	2500	Green (RoHS & no Sb/Br)	CU NIPDAU	Level-1-260C-UNLIM	-40 to 85	TL2842B	<a href="#">Samples</a>
TL2842BDR-8	ACTIVE	SOIC	D	8	2500	Green (RoHS & no Sb/Br)	CU NIPDAU	Level-1-260C-UNLIM	-40 to 85	2842B	<a href="#">Samples</a>
TL2842BP	ACTIVE	PDIP	P	8	50	Pb-Free (RoHS)	CU NIPDAU	N / A for Pkg Type	-40 to 85	TL2842BP	<a href="#">Samples</a>
TL2843BD	ACTIVE	SOIC	D	14	50	Green (RoHS & no Sb/Br)	CU NIPDAU	Level-1-260C-UNLIM	-40 to 85	TL2843B	<a href="#">Samples</a>
TL2843BD-8	ACTIVE	SOIC	D	8	75	Green (RoHS & no Sb/Br)	CU NIPDAU	Level-1-260C-UNLIM	-40 to 85	2843B	<a href="#">Samples</a>
TL2843BDR	ACTIVE	SOIC	D	14	2500	Green (RoHS & no Sb/Br)	CU NIPDAU	Level-1-260C-UNLIM	-40 to 85	TL2843B	<a href="#">Samples</a>
TL2843BDR-8	ACTIVE	SOIC	D	8	2500	Green (RoHS & no Sb/Br)	CU NIPDAU	Level-1-260C-UNLIM	-40 to 85	2843B	<a href="#">Samples</a>
TL2843BDRG4-8	ACTIVE	SOIC	D	8	2500	Green (RoHS & no Sb/Br)	CU NIPDAU	Level-1-260C-UNLIM	-40 to 85	2843B	<a href="#">Samples</a>
TL2843BP	ACTIVE	PDIP	P	8	50	Pb-Free (RoHS)	CU NIPDAU	N / A for Pkg Type	-40 to 85	TL2843BP	<a href="#">Samples</a>
TL2843BPG4	ACTIVE	PDIP	P	8		TBD	Call TI	Call TI	-40 to 85		<a href="#">Samples</a>
TL2844BD-8	ACTIVE	SOIC	D	8	75	Green (RoHS & no Sb/Br)	CU NIPDAU	Level-1-260C-UNLIM	-40 to 85	2844B	<a href="#">Samples</a>
TL2844BDR	ACTIVE	SOIC	D	14	2500	Green (RoHS & no Sb/Br)	CU NIPDAU	Level-1-260C-UNLIM	-40 to 85	TL2844B	<a href="#">Samples</a>
TL2844BDR-8	ACTIVE	SOIC	D	8	2500	Green (RoHS & no Sb/Br)	CU NIPDAU	Level-1-260C-UNLIM	-40 to 85	2844B	<a href="#">Samples</a>
TL2844BDRG4-8	ACTIVE	SOIC	D	8	2500	Green (RoHS & no Sb/Br)	CU NIPDAU	Level-1-260C-UNLIM	-40 to 85	2844B	<a href="#">Samples</a>
TL2845BD	ACTIVE	SOIC	D	14	50	Green (RoHS & no Sb/Br)	CU NIPDAU	Level-1-260C-UNLIM	-40 to 85	TL2845B	<a href="#">Samples</a>

Orderable Device	Status (1)	Package Type	Package Drawing	Pins	Package Qty	Eco Plan (2)	Lead/Ball Finish (6)	MSL Peak Temp (3)	Op Temp (°C)	Device Marking (4/5)	Samples
TL2845BD-8	ACTIVE	SOIC	D	8	75	Green (RoHS & no Sb/Br)	CU NIPDAU	Level-1-260C-UNLIM	-40 to 85	2845B	<a href="#">Samples</a>
TL2845BDR	ACTIVE	SOIC	D	14	2500	Green (RoHS & no Sb/Br)	CU NIPDAU	Level-1-260C-UNLIM	-40 to 85	TL2845B	<a href="#">Samples</a>
TL2845BDR-8	ACTIVE	SOIC	D	8	2500	Green (RoHS & no Sb/Br)	CU NIPDAU	Level-1-260C-UNLIM	-40 to 85	2845B	<a href="#">Samples</a>
TL2845BDRG4-8	ACTIVE	SOIC	D	8	2500	Green (RoHS & no Sb/Br)	CU NIPDAU	Level-1-260C-UNLIM	-40 to 85	2845B	<a href="#">Samples</a>
TL2845BP	ACTIVE	PDIP	P	8	50	Pb-Free (RoHS)	CU NIPDAU	N / A for Pkg Type	-40 to 85	TL2845BP	<a href="#">Samples</a>
TL3842BD	ACTIVE	SOIC	D	14	50	Green (RoHS & no Sb/Br)	CU NIPDAU	Level-1-260C-UNLIM	0 to 70	TL3842B	<a href="#">Samples</a>
TL3842BD-8	ACTIVE	SOIC	D	8	75	Green (RoHS & no Sb/Br)	CU NIPDAU	Level-1-260C-UNLIM	0 to 70	3842B	<a href="#">Samples</a>
TL3842BDR	ACTIVE	SOIC	D	14	2500	Green (RoHS & no Sb/Br)	CU NIPDAU	Level-1-260C-UNLIM	0 to 70	TL3842B	<a href="#">Samples</a>
TL3842BDR-8	ACTIVE	SOIC	D	8	2500	Green (RoHS & no Sb/Br)	CU NIPDAU	Level-1-260C-UNLIM	0 to 70	3842B	<a href="#">Samples</a>
TL3842BP	ACTIVE	PDIP	P	8	50	Pb-Free (RoHS)	CU NIPDAU	N / A for Pkg Type	0 to 70	TL3842BP	<a href="#">Samples</a>
TL3842BPE4	ACTIVE	PDIP	P	8	50	Pb-Free (RoHS)	CU NIPDAU	N / A for Pkg Type	0 to 70	TL3842BP	<a href="#">Samples</a>
TL3843BD	ACTIVE	SOIC	D	14	50	Green (RoHS & no Sb/Br)	CU NIPDAU	Level-1-260C-UNLIM	0 to 70	TL3843B	<a href="#">Samples</a>
TL3843BD-8	ACTIVE	SOIC	D	8	75	Green (RoHS & no Sb/Br)	CU NIPDAU	Level-1-260C-UNLIM	0 to 70	3843B	<a href="#">Samples</a>
TL3843BDR	ACTIVE	SOIC	D	14	2500	Green (RoHS & no Sb/Br)	CU NIPDAU	Level-1-260C-UNLIM	0 to 70	TL3843B	<a href="#">Samples</a>
TL3843BDR-8	ACTIVE	SOIC	D	8	2500	Green (RoHS & no Sb/Br)	CU NIPDAU	Level-1-260C-UNLIM	0 to 70	3843B	<a href="#">Samples</a>
TL3843BDRG4	ACTIVE	SOIC	D	14	2500	Green (RoHS & no Sb/Br)	CU NIPDAU	Level-1-260C-UNLIM	0 to 70	TL3843B	<a href="#">Samples</a>
TL3843BP	ACTIVE	PDIP	P	8	50	Pb-Free (RoHS)	CU NIPDAU	N / A for Pkg Type	0 to 70	TL3843BP	<a href="#">Samples</a>
TL3843BPE4	ACTIVE	PDIP	P	8	50	Pb-Free (RoHS)	CU NIPDAU	N / A for Pkg Type	0 to 70	TL3843BP	<a href="#">Samples</a>

Orderable Device	Status (1)	Package Type	Package Drawing	Pins	Package Qty	Eco Plan (2)	Lead/Ball Finish (6)	MSL Peak Temp (3)	Op Temp (°C)	Device Marking (4/5)	Samples
TL3844BD-8	ACTIVE	SOIC	D	8	75	Green (RoHS & no Sb/Br)	CU NIPDAU	Level-1-260C-UNLIM	0 to 70	3844B	<a href="#">Samples</a>
TL3844BDR	ACTIVE	SOIC	D	14	2500	Green (RoHS & no Sb/Br)	CU NIPDAU	Level-1-260C-UNLIM	0 to 70	TL3844B	<a href="#">Samples</a>
TL3844BDR-8	ACTIVE	SOIC	D	8	2500	Green (RoHS & no Sb/Br)	CU NIPDAU	Level-1-260C-UNLIM	0 to 70	3844B	<a href="#">Samples</a>
TL3844BP	ACTIVE	PDIP	P	8	50	Pb-Free (RoHS)	CU NIPDAU	N / A for Pkg Type	0 to 70	TL3844BP	<a href="#">Samples</a>
TL3844BPE4	ACTIVE	PDIP	P	8	50	Pb-Free (RoHS)	CU NIPDAU	N / A for Pkg Type	0 to 70	TL3844BP	<a href="#">Samples</a>
TL3845BD	ACTIVE	SOIC	D	14	50	Green (RoHS & no Sb/Br)	CU NIPDAU	Level-1-260C-UNLIM	0 to 70	TL3845B	<a href="#">Samples</a>
TL3845BD-8	ACTIVE	SOIC	D	8	75	Green (RoHS & no Sb/Br)	CU NIPDAU	Level-1-260C-UNLIM	0 to 70	3845B	<a href="#">Samples</a>
TL3845BDG4-8	ACTIVE	SOIC	D	8	75	Green (RoHS & no Sb/Br)	CU NIPDAU	Level-1-260C-UNLIM	0 to 70	3845B	<a href="#">Samples</a>
TL3845BDR	ACTIVE	SOIC	D	14	2500	Green (RoHS & no Sb/Br)	CU NIPDAU	Level-1-260C-UNLIM	0 to 70	TL3845B	<a href="#">Samples</a>
TL3845BDR-8	ACTIVE	SOIC	D	8	2500	Green (RoHS & no Sb/Br)	CU NIPDAU	Level-1-260C-UNLIM	0 to 70	3845B	<a href="#">Samples</a>
TL3845BP	ACTIVE	PDIP	P	8	50	Pb-Free (RoHS)	CU NIPDAU	N / A for Pkg Type	0 to 70	TL3845BP	<a href="#">Samples</a>

(1) The marketing status values are defined as follows:

**ACTIVE:** Product device recommended for new designs.

**LIFEBUY:** TI has announced that the device will be discontinued, and a lifetime-buy period is in effect.

**NRND:** Not recommended for new designs. Device is in production to support existing customers, but TI does not recommend using this part in a new design.

**PREVIEW:** Device has been announced but is not in production. Samples may or may not be available.

**OBSELETE:** TI has discontinued the production of the device.

(2) Eco Plan - The planned eco-friendly classification: Pb-Free (RoHS), Pb-Free (RoHS Exempt), or Green (RoHS & no Sb/Br) - please check <http://www.ti.com/productcontent> for the latest availability information and additional product content details.

**TBD:** The Pb-Free/Green conversion plan has not been defined.

**Pb-Free (RoHS):** TI's terms "Lead-Free" or "Pb-Free" mean semiconductor products that are compatible with the current RoHS requirements for all 6 substances, including the requirement that lead not exceed 0.1% by weight in homogeneous materials. Where designed to be soldered at high temperatures, TI Pb-Free products are suitable for use in specified lead-free processes.

**Pb-Free (RoHS Exempt):** This component has a RoHS exemption for either 1) lead-based flip-chip solder bumps used between the die and package, or 2) lead-based die adhesive used between the die and leadframe. The component is otherwise considered Pb-Free (RoHS compatible) as defined above.



---

**Green (RoHS & no Sb/Br):** TI defines "Green" to mean Pb-Free (RoHS compatible), and free of Bromine (Br) and Antimony (Sb) based flame retardants (Br or Sb do not exceed 0.1% by weight in homogeneous material)

(3) MSL, Peak Temp. - The Moisture Sensitivity Level rating according to the JEDEC industry standard classifications, and peak solder temperature.

(4) There may be additional marking, which relates to the logo, the lot trace code information, or the environmental category on the device.

(5) Multiple Device Markings will be inside parentheses. Only one Device Marking contained in parentheses and separated by a "~" will appear on a device. If a line is indented then it is a continuation of the previous line and the two combined represent the entire Device Marking for that device.

(6) Lead/Ball Finish - Orderable Devices may have multiple material finish options. Finish options are separated by a vertical ruled line. Lead/Ball Finish values may wrap to two lines if the finish value exceeds the maximum column width.

**Important Information and Disclaimer:** The information provided on this page represents TI's knowledge and belief as of the date that it is provided. TI bases its knowledge and belief on information provided by third parties, and makes no representation or warranty as to the accuracy of such information. Efforts are underway to better integrate information from third parties. TI has taken and continues to take reasonable steps to provide representative and accurate information but may not have conducted destructive testing or chemical analysis on incoming materials and chemicals. TI and TI suppliers consider certain information to be proprietary, and thus CAS numbers and other limited information may not be available for release.

In no event shall TI's liability arising out of such information exceed the total purchase price of the TI part(s) at issue in this document sold by TI to Customer on an annual basis.

**OTHER QUALIFIED VERSIONS OF TL2843B :**

- Automotive: [TL2843B-Q1](#)

NOTE: Qualified Version Definitions:

- Automotive - Q100 devices qualified for high-reliability automotive applications targeting zero defects

## TAPE AND REEL INFORMATION

### REEL DIMENSIONS



### TAPE DIMENSIONS



A0	Dimension designed to accommodate the component width
B0	Dimension designed to accommodate the component length
K0	Dimension designed to accommodate the component thickness
W	Overall width of the carrier tape
P1	Pitch between successive cavity centers

### TAPE AND REEL INFORMATION

\*All dimensions are nominal

Device	Package Type	Package Drawing	Pins	SPQ	Reel Diameter (mm)	Reel Width W1 (mm)	A0 (mm)	B0 (mm)	K0 (mm)	P1 (mm)	W (mm)	Pin1 Quadrant
TL2842BDR	SOIC	D	14	2500	330.0	16.4	6.5	9.0	2.1	8.0	16.0	Q1
TL2842BDR-8	SOIC	D	8	2500	330.0	12.4	6.4	5.2	2.1	8.0	12.0	Q1
TL2843BDR	SOIC	D	14	2500	330.0	16.4	6.5	9.0	2.1	8.0	16.0	Q1
TL2843BDR-8	SOIC	D	8	2500	330.0	12.4	6.4	5.2	2.1	8.0	12.0	Q1
TL2844BDR	SOIC	D	14	2500	330.0	16.4	6.5	9.0	2.1	8.0	16.0	Q1
TL2844BDR-8	SOIC	D	8	2500	330.0	12.4	6.4	5.2	2.1	8.0	12.0	Q1
TL2845BDR	SOIC	D	14	2500	330.0	16.4	6.5	9.0	2.1	8.0	16.0	Q1
TL2845BDR-8	SOIC	D	8	2500	330.0	12.4	6.4	5.2	2.1	8.0	12.0	Q1
TL3842BDR	SOIC	D	14	2500	330.0	16.4	6.5	9.0	2.1	8.0	16.0	Q1
TL3842BDR-8	SOIC	D	8	2500	330.0	12.4	6.4	5.2	2.1	8.0	12.0	Q1
TL3843BDR	SOIC	D	14	2500	330.0	16.4	6.5	9.0	2.1	8.0	16.0	Q1
TL3843BDR-8	SOIC	D	8	2500	330.0	12.4	6.4	5.2	2.1	8.0	12.0	Q1
TL3844BDR	SOIC	D	14	2500	330.0	16.4	6.5	9.0	2.1	8.0	16.0	Q1
TL3844BDR-8	SOIC	D	8	2500	330.0	12.4	6.4	5.2	2.1	8.0	12.0	Q1
TL3845BDR	SOIC	D	14	2500	330.0	16.4	6.5	9.0	2.1	8.0	16.0	Q1
TL3845BDR-8	SOIC	D	8	2500	330.0	12.4	6.4	5.2	2.1	8.0	12.0	Q1

**TAPE AND REEL BOX DIMENSIONS**

\*All dimensions are nominal

Device	Package Type	Package Drawing	Pins	SPQ	Length (mm)	Width (mm)	Height (mm)
TL2842BDR	SOIC	D	14	2500	367.0	367.0	38.0
TL2842BDR-8	SOIC	D	8	2500	340.5	338.1	20.6
TL2843BDR	SOIC	D	14	2500	367.0	367.0	38.0
TL2843BDR-8	SOIC	D	8	2500	340.5	338.1	20.6
TL2844BDR	SOIC	D	14	2500	367.0	367.0	38.0
TL2844BDR-8	SOIC	D	8	2500	340.5	338.1	20.6
TL2845BDR	SOIC	D	14	2500	367.0	367.0	38.0
TL2845BDR-8	SOIC	D	8	2500	340.5	338.1	20.6
TL3842BDR	SOIC	D	14	2500	367.0	367.0	38.0
TL3842BDR-8	SOIC	D	8	2500	340.5	338.1	20.6
TL3843BDR	SOIC	D	14	2500	367.0	367.0	38.0
TL3843BDR-8	SOIC	D	8	2500	340.5	338.1	20.6
TL3844BDR	SOIC	D	14	2500	367.0	367.0	38.0
TL3844BDR-8	SOIC	D	8	2500	340.5	338.1	20.6
TL3845BDR	SOIC	D	14	2500	367.0	367.0	38.0
TL3845BDR-8	SOIC	D	8	2500	340.5	338.1	20.6

P (R-PDIP-T8)

PLASTIC DUAL-IN-LINE PACKAGE





- NOTES:
- A. All linear dimensions are in inches (millimeters).
  - B. This drawing is subject to change without notice.
  - C. Falls within JEDEC MS-001 variation BA.

D (R-PDSO-G14)

PLASTIC SMALL OUTLINE



4040047-5/M 06/11

- NOTES:
- A. All linear dimensions are in inches (millimeters).
  - B. This drawing is subject to change without notice.
  -  Body length does not include mold flash, protrusions, or gate burrs. Mold flash, protrusions, or gate burrs shall not exceed 0.006 (0,15) each side.
  -  Body width does not include interlead flash. Interlead flash shall not exceed 0.017 (0,43) each side.
  - E. Reference JEDEC MS-012 variation AB.

D (R-PDSO-G14)

PLASTIC SMALL OUTLINE



- NOTES:
- A. All linear dimensions are in millimeters.
  - B. This drawing is subject to change without notice.
  - C. Publication IPC-7351 is recommended for alternate designs.
  - D. Laser cutting apertures with trapezoidal walls and also rounding corners will offer better paste release. Customers should contact their board assembly site for stencil design recommendations. Refer to IPC-7525 for other stencil recommendations.
  - E. Customers should contact their board fabrication site for solder mask tolerances between and around signal pads.



## IMPORTANT NOTICE

Texas Instruments Incorporated and its subsidiaries (TI) reserve the right to make corrections, enhancements, improvements and other changes to its semiconductor products and services per JESD46, latest issue, and to discontinue any product or service per JESD48, latest issue. Buyers should obtain the latest relevant information before placing orders and should verify that such information is current and complete. All semiconductor products (also referred to herein as "components") are sold subject to TI's terms and conditions of sale supplied at the time of order acknowledgment.

TI warrants performance of its components to the specifications applicable at the time of sale, in accordance with the warranty in TI's terms and conditions of sale of semiconductor products. Testing and other quality control techniques are used to the extent TI deems necessary to support this warranty. Except where mandated by applicable law, testing of all parameters of each component is not necessarily performed.

TI assumes no liability for applications assistance or the design of Buyers' products. Buyers are responsible for their products and applications using TI components. To minimize the risks associated with Buyers' products and applications, Buyers should provide adequate design and operating safeguards.

TI does not warrant or represent that any license, either express or implied, is granted under any patent right, copyright, mask work right, or other intellectual property right relating to any combination, machine, or process in which TI components or services are used. Information published by TI regarding third-party products or services does not constitute a license to use such products or services or a warranty or endorsement thereof. Use of such information may require a license from a third party under the patents or other intellectual property of the third party, or a license from TI under the patents or other intellectual property of TI.

Reproduction of significant portions of TI information in TI data books or data sheets is permissible only if reproduction is without alteration and is accompanied by all associated warranties, conditions, limitations, and notices. TI is not responsible or liable for such altered documentation. Information of third parties may be subject to additional restrictions.

Resale of TI components or services with statements different from or beyond the parameters stated by TI for that component or service voids all express and any implied warranties for the associated TI component or service and is an unfair and deceptive business practice. TI is not responsible or liable for any such statements.

Buyer acknowledges and agrees that it is solely responsible for compliance with all legal, regulatory and safety-related requirements concerning its products, and any use of TI components in its applications, notwithstanding any applications-related information or support that may be provided by TI. Buyer represents and agrees that it has all the necessary expertise to create and implement safeguards which anticipate dangerous consequences of failures, monitor failures and their consequences, lessen the likelihood of failures that might cause harm and take appropriate remedial actions. Buyer will fully indemnify TI and its representatives against any damages arising out of the use of any TI components in safety-critical applications.

In some cases, TI components may be promoted specifically to facilitate safety-related applications. With such components, TI's goal is to help enable customers to design and create their own end-product solutions that meet applicable functional safety standards and requirements. Nonetheless, such components are subject to these terms.

No TI components are authorized for use in FDA Class III (or similar life-critical medical equipment) unless authorized officers of the parties have executed a special agreement specifically governing such use.

Only those TI components which TI has specifically designated as military grade or "enhanced plastic" are designed and intended for use in military/aerospace applications or environments. Buyer acknowledges and agrees that any military or aerospace use of TI components which have **not** been so designated is solely at the Buyer's risk, and that Buyer is solely responsible for compliance with all legal and regulatory requirements in connection with such use.

TI has specifically designated certain components as meeting ISO/TS16949 requirements, mainly for automotive use. In any case of use of non-designated products, TI will not be responsible for any failure to meet ISO/TS16949.

### Products

Audio	<a href="http://www.ti.com/audio">www.ti.com/audio</a>
Amplifiers	<a href="http://amplifier.ti.com">amplifier.ti.com</a>
Data Converters	<a href="http://dataconverter.ti.com">dataconverter.ti.com</a>
DLP® Products	<a href="http://www.dlp.com">www.dlp.com</a>
DSP	<a href="http://dsp.ti.com">dsp.ti.com</a>
Clocks and Timers	<a href="http://www.ti.com/clocks">www.ti.com/clocks</a>
Interface	<a href="http://interface.ti.com">interface.ti.com</a>
Logic	<a href="http://logic.ti.com">logic.ti.com</a>
Power Mgmt	<a href="http://power.ti.com">power.ti.com</a>
Microcontrollers	<a href="http://microcontroller.ti.com">microcontroller.ti.com</a>
RFID	<a href="http://www.ti-rfid.com">www.ti-rfid.com</a>
OMAP Applications Processors	<a href="http://www.ti.com/omap">www.ti.com/omap</a>
Wireless Connectivity	<a href="http://www.ti.com/wirelessconnectivity">www.ti.com/wirelessconnectivity</a>

### Applications

Automotive and Transportation	<a href="http://www.ti.com/automotive">www.ti.com/automotive</a>
Communications and Telecom	<a href="http://www.ti.com/communications">www.ti.com/communications</a>
Computers and Peripherals	<a href="http://www.ti.com/computers">www.ti.com/computers</a>
Consumer Electronics	<a href="http://www.ti.com/consumer-apps">www.ti.com/consumer-apps</a>
Energy and Lighting	<a href="http://www.ti.com/energy">www.ti.com/energy</a>
Industrial	<a href="http://www.ti.com/industrial">www.ti.com/industrial</a>
Medical	<a href="http://www.ti.com/medical">www.ti.com/medical</a>
Security	<a href="http://www.ti.com/security">www.ti.com/security</a>
Space, Avionics and Defense	<a href="http://www.ti.com/space-avionics-defense">www.ti.com/space-avionics-defense</a>
Video and Imaging	<a href="http://www.ti.com/video">www.ti.com/video</a>

### TI E2E Community

[e2e.ti.com](http://e2e.ti.com)