

<http://vcc-gnd.taobao.com/>

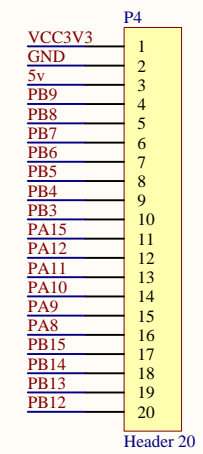
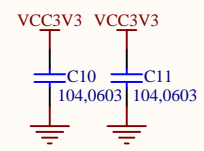
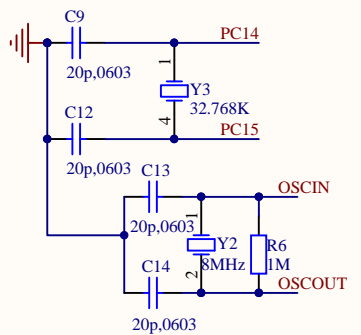
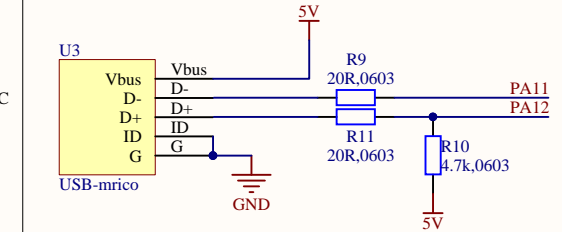
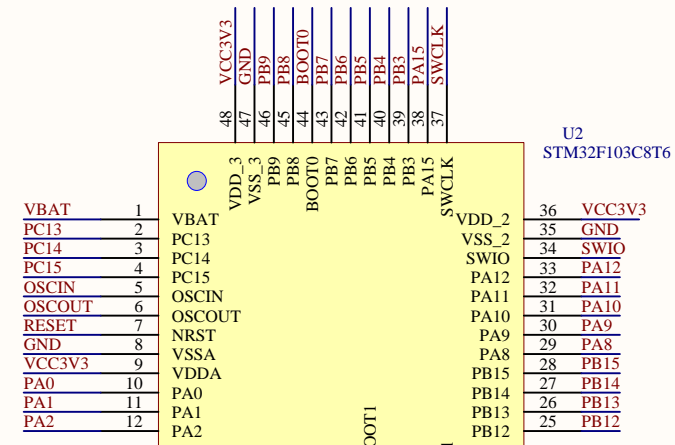
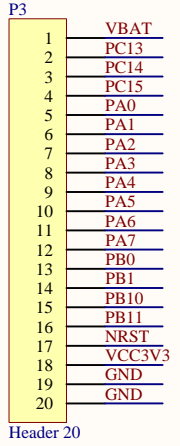
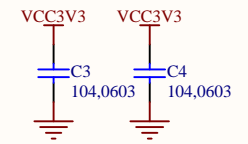
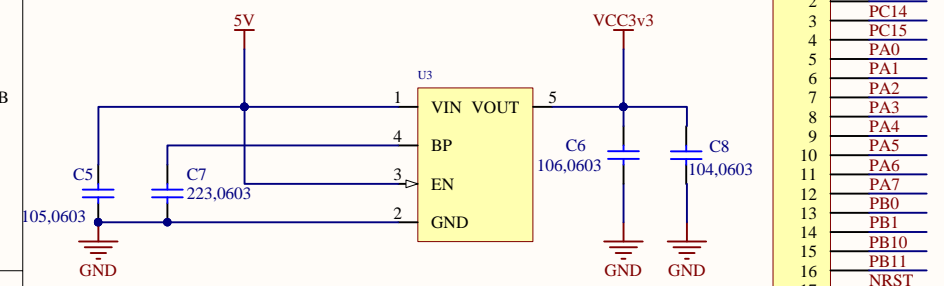
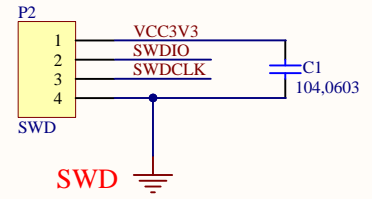
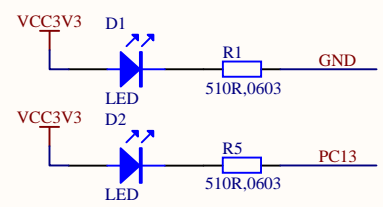
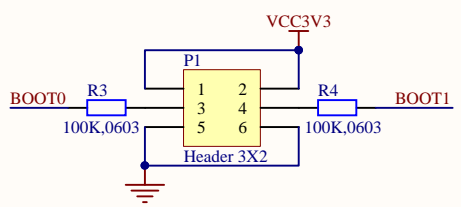
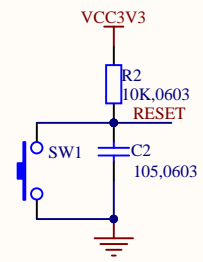

Title		
STM32F103C8T6		
Size	Number	Revision
A4	www.vcc-gnd.com	
Date:	2014/6/2	
File:	X:\STM32F103C8T6.SchDoc	