

STM32 microcontroller system memory boot mode

Introduction

The bootloader is stored in the internal boot ROM memory (system memory) of STM32 devices. It is programmed by ST during production. Its main task is to download the application program to the internal Flash memory through one of the available serial peripherals (USART, CAN, USB, I²C, SPI, etc.). A communication protocol is defined for each serial interface, with a compatible command set and sequences. This document applies to the products listed in [Table 1](#). They are referred as STM32 throughout the document.

Table 1. Applicable products

Type	Part number or product series
Microcontrollers	STM32F0 Series: STM32F03xxx, STM32F04xxx, STM32F05xxx, STM32F07xxx, STM32F09xxx
	STM32F1 Series.
	STM32F2 Series.
	STM32F3 Series: STM32F301xx, STM32F302xx, STM32F303xx, STM32F318xx, STM32F328xx, STM32F334xx, STM32F358xx, STM32F373xx, STM32F378xx, STM32F398xx
	STM32F4 Series: STM32F401xx, STM32F405xx, STM32F407xx, STM32F410xx, STM32F411xx, STM32F412xx, STM32F413xx, STM32F415xx, STM32F417xx, STM32F423xx, STM32F427xx, STM32F429xx, STM32F437xx, STM32F439xx, STM32F446xx, STM32F469xx, STM32F479xx
	STM32F7 Series: STM32F722xx, STM32F723xx, STM32F732xx, STM32F733xx, STM32F745xx, STM32F746xx, STM32F756xx, STM32F765xx, STM32F767xx, STM32F769xx, STM32F777xx, STM32F779xx
	STM32G0 Series: STM32G030xx, STM32G031xx, STM32G041xx, STM32G07xxx, STM32G08xxx,
	STM32G4 Series: STM32G431xx, STM32G441xx, STM32G47xxx, STM32G48xxx
	STM32H7 Series: STM32H743xx, STM32H753xx
	STM32L0 Series.
	STM32L1 Series: STM32L100xx, STM32L151xx, STM32L152xx, STM32L162xx
	STM32L4 series: STM32L431xx, STM32L432xx, STM32L433xx, STM32L442xx, STM32L443xx, STM32L451xx, STM32L452xx, STM32L462xx, STM32L471xx, STM32L475xx, STM32L476xx, STM32L486xx, STM32L496xx, STM32L4A6xx, STM32L4R5xx, STM32L4R7xx, STM32L4R9xx, STM32L4S5xx, STM32L4S7xx, STM32L4S9xx, STM32L412xx, STM32L422xx
	STM32L5 Series: STM32L552xx, STM32L562xx
	STM32WB series: STM32WB50xx, STM32WB55xx

This application note describes the supported peripherals and hardware requirements to be considered when using the bootloader of STM32 devices. However the specifications of the low-level communication protocol for each supported serial peripheral are documented in separate documents as referred in [Section 2: Related documents](#).

Contents

1	General information	17
2	Related documents	17
3	Glossary	18
4	General bootloader description	22
4.1	Bootloader activation	22
4.2	Bootloader identification	24
4.3	Hardware connection requirements	31
4.4	Bootloader memory management	33
5	STM32F03xx4/6 devices bootloader	35
5.1	Bootloader configuration	35
5.2	Bootloader selection	36
5.3	Bootloader version	36
6	STM32F030xC devices bootloader	37
6.1	Bootloader configuration	37
6.2	Bootloader selection	38
6.3	Bootloader version	38
7	STM32F05xxx and STM32F030x8 devices bootloader	39
7.1	Bootloader configuration	39
7.2	Bootloader selection	40
7.3	Bootloader version	40
8	STM32F04xxx devices bootloader	41
8.1	Bootloader configuration	41
8.2	Bootloader selection	43
8.3	Bootloader version	44
9	STM32F070x6 devices bootloader	45

9.1	Bootloader configuration	45
9.2	Bootloader selection	47
9.3	Bootloader version	48
10	STM32F070xB devices bootloader	49
10.1	Bootloader configuration	49
10.2	Bootloader selection	51
10.3	Bootloader version	52
11	STM32F071xx/072xx devices bootloader	53
11.1	Bootloader configuration	53
11.2	Bootloader selection	55
11.3	Bootloader version	55
12	STM32F09xxx devices bootloader	56
12.1	Bootloader configuration	56
12.2	Bootloader selection	57
12.3	Bootloader version	57
13	STM32F10xxx devices bootloader	58
13.1	Bootloader configuration	58
13.2	Bootloader selection	59
13.3	Bootloader version	59
14	STM32F105xx/107xx devices bootloader	61
14.1	Bootloader configuration	61
14.2	Bootloader selection	63
14.3	Bootloader version	64
14.3.1	How to identify STM32F105xx/107xx bootloader versions	64
14.3.2	Bootloader unavailability on STM32F105xx/STM32F107xx devices with a date code below 937	65
14.3.3	USART bootloader Get-Version command returns 0x20 instead of 0x22	66
14.3.4	PA9 excessive power consumption when USB cable is plugged in bootloader V2.0	66
15	STM32F10xxx XL-density devices bootloader	67

15.1	Bootloader configuration	67
15.2	Bootloader selection	68
15.3	Bootloader version	68
16	STM32F2xxx devices bootloader	70
16.1	Bootloader V2.x	70
16.1.1	Bootloader configuration	70
16.1.2	Bootloader selection	71
16.1.3	Bootloader version	72
16.2	Bootloader V3.x	73
16.2.1	Bootloader configuration	73
16.2.2	Bootloader selection	75
16.2.3	Bootloader version	76
17	STM32F301xx/302x4(6/8) devices bootloader	77
17.1	Bootloader configuration	77
17.2	Bootloader selection	79
17.3	Bootloader version	79
18	STM32F302xB(C)/303xB(C) devices bootloader	80
18.1	Bootloader configuration	80
18.2	Bootloader selection	82
18.3	Bootloader version	82
19	STM32F302xD(E)/303xD(E) devices bootloader	83
19.1	Bootloader configuration	83
19.2	Bootloader selection	85
19.3	Bootloader version	86
20	STM32F303x4(6/8)/334xx/328xx devices bootloader	87
20.1	Bootloader configuration	87
20.2	Bootloader selection	88
20.3	Bootloader version	88
21	STM32F318xx devices bootloader	89
21.1	Bootloader configuration	89

21.2	Bootloader selection	90
21.3	Bootloader version	91
22	STM32F358xx devices bootloader	92
22.1	Bootloader configuration	92
22.2	Bootloader selection	93
22.3	Bootloader version	93
23	STM32F373xx devices bootloader	94
23.1	Bootloader configuration	94
23.2	Bootloader selection	96
23.3	Bootloader version	96
24	STM32F378xx devices bootloader	97
24.1	Bootloader configuration	97
24.2	Bootloader selection	98
24.3	Bootloader version	98
25	STM32F398xx devices bootloader	99
25.1	Bootloader configuration	99
25.2	Bootloader selection	100
25.3	Bootloader version	100
26	STM32F40xxx/41xxx devices bootloader	101
26.1	Bootloader V3.x	101
26.1.1	Bootloader configuration	101
26.1.2	Bootloader selection	103
26.1.3	Bootloader version	104
26.2	Bootloader V9.x	105
26.2.1	Bootloader configuration	105
26.2.2	Bootloader selection	109
26.2.3	Bootloader version	110
27	STM32F401xB(C) devices bootloader	111
27.1	Bootloader configuration	111
27.2	Bootloader selection	115

27.3	Bootloader version	116
28	STM32F401xD(E) devices bootloader	117
28.1	Bootloader configuration	117
28.2	Bootloader selection	120
28.3	Bootloader version	121
29	STM32F410xx devices bootloader	122
29.1	Bootloader configuration	122
29.2	Bootloader selection	125
29.3	Bootloader version	126
30	STM32F411xx devices bootloader	127
30.1	Bootloader configuration	127
30.2	Bootloader selection	131
30.3	Bootloader version	132
31	STM32F412xx devices bootloader	133
31.1	Bootloader configuration	133
31.2	Bootloader selection	137
31.3	Bootloader version	138
32	STM32F413xx/423xx devices bootloader	139
32.1	Bootloader configuration	139
32.2	Bootloader selection	143
32.3	Bootloader version	144
33	STM32F42xxx/43xxx devices bootloader	145
33.1	Bootloader V7.x	145
33.1.1	Bootloader configuration	145
33.1.2	Bootloader selection	147
33.1.3	Bootloader version	149
33.2	Bootloader V9.x	150
33.2.1	Bootloader configuration	150
33.2.2	Bootloader selection	154
33.2.3	Bootloader version	156

34	STM32F446xx devices bootloader	157
	34.1 Bootloader configuration	157
	34.2 Bootloader selection	161
	34.3 Bootloader version	162
35	STM32F469xx/479xx devices bootloader	163
	35.1 Bootloader configuration	163
	35.2 Bootloader selection	167
	35.3 Bootloader version	169
36	STM32F72xxx/73xxx devices bootloader	170
	36.1 Bootloader configuration	170
	36.2 Bootloader selection	174
	36.3 Bootloader version	175
37	STM32F74xxx/75xxx devices bootloader	176
	37.1 Bootloader V7.x	176
	37.1.1 Bootloader configuration	176
	37.1.2 Bootloader selection	179
	37.1.3 Bootloader version	180
	37.2 Bootloader V9.x	181
	37.2.1 Bootloader configuration	181
	37.2.2 Bootloader selection	185
	37.2.3 Bootloader version	186
38	STM32F76xxx/77xxx devices bootloader	187
	38.1 Bootloader configuration	187
	38.2 Bootloader selection	190
	38.3 Bootloader version	193
39	STM32G03xxx/ STM32G04xxx devices bootloader	194
	39.1 Bootloader configuration	194
	39.2 Bootloader selection	196
	39.3 Bootloader version	197
40	STM32G07xxx/08xxx device bootloader	199

40.1	Bootloader configuration	199
40.2	Bootloader selection	202
40.3	Bootloader version	202
41	STM32G431xx/441xx devices bootloader	203
41.1	Bootloader configuration	203
41.2	Bootloader selection	207
41.3	Bootloader version	208
42	STM32G47xxx/48xxx devices bootloader	209
42.1	Bootloader Configuration	209
42.2	Bootloader selection	213
42.3	Bootloader version	214
43	STM32H74xxx/75xxx devices bootloader	215
43.1	Bootloader configuration	215
43.2	Bootloader selection	219
43.3	Bootloader version	219
44	STM32L01xxx/02xxx devices bootloader	221
44.1	Bootloader configuration	221
44.2	Bootloader selection	223
44.3	Bootloader version	224
45	STM32L031xx/041xx devices bootloader	225
45.1	Bootloader configuration	225
45.2	Bootloader selection	227
45.3	Bootloader version	227
46	STM32L05xxx/06xxx devices bootloader	228
46.1	Bootloader configuration	228
46.2	Bootloader selection	230
46.3	Bootloader version	230
47	STM32L07xxx/08xxx devices bootloader	231

47.1	Bootloader V4.x	231
47.1.1	Bootloader configuration	231
47.1.2	Bootloader selection	233
47.1.3	Bootloader version	234
47.2	Bootloader V11.x	235
47.2.1	Bootloader configuration	235
47.2.2	Bootloader selection	237
47.2.3	Bootloader version	239
48	STM32L1xxx6(8/B)A devices bootloader	240
48.1	Bootloader configuration	240
48.2	Bootloader selection	241
48.3	Bootloader version	241
49	STM32L1xxx6(8/B) devices bootloader	242
49.1	Bootloader configuration	242
49.2	Bootloader selection	243
49.3	Bootloader version	243
50	STM32L1xxxC devices bootloader	244
50.1	Bootloader configuration	244
50.2	Bootloader selection	246
50.3	Bootloader version	246
51	STM32L1xxxD devices bootloader	247
51.1	Bootloader configuration	247
51.2	Bootloader selection	249
51.3	Bootloader version	250
52	STM32L1xxxE devices bootloader	251
52.1	Bootloader configuration	251
52.2	Bootloader selection	253
52.3	Bootloader version	254
53	STM32L412xx/422xx devices bootloader	255
53.1	Bootloader configuration	255

53.2	Bootloader selection	258
53.3	Bootloader version	259
54	STM32L43xxx/44xxx devices bootloader	260
54.1	Bootloader configuration	260
54.2	Bootloader selection	264
54.3	Bootloader version	265
55	STM32L45xxx/46xxx devices bootloader	266
55.1	Bootloader configuration	266
55.2	Bootloader selection	270
55.3	Bootloader version	271
56	STM32L47xxx/48xxx devices bootloader	272
56.1	Bootloader V10.x	272
56.1.1	Bootloader configuration	272
56.1.2	Bootloader selection	275
56.1.3	Bootloader version	277
56.2	Bootloader V9.x	278
56.2.1	Bootloader configuration	278
56.2.2	Bootloader selection	281
56.2.3	Bootloader version	283
57	STM32L496xx/4A6xx devices bootloader	284
57.1	Bootloader configuration	284
57.2	Bootloader selection	288
57.3	Bootloader version	289
58	STM32L4Rxxx/4Sxxx devices bootloader	290
58.1	Bootloader configuration	290
58.2	Bootloader selection	294
58.3	Bootloader version	296
59	STM32L52xx/STM32L562xx devices bootloader	297
59.1	Bootloader configuration	297
59.2	Bootloader selection	300

59.3	Bootloader version	301
60	STM32WB50xx/55xx devices bootloader	302
60.1	Bootloader configuration	302
60.2	Bootloader selection	305
60.3	Bootloader version	306
61	Device-dependent bootloader parameters	307
62	Bootloader timing	310
62.1	Bootloader Startup timing	310
62.2	USART connection timing	313
62.3	USB connection timing	315
62.4	I2C connection timing	318
62.5	SPI connection timing	320
63	Revision history	321

List of tables

Table 1.	Applicable products	1
Table 2.	Bootloader activation patterns	22
Table 3.	Embedded bootloaders	25
Table 4.	STM32 F2, F4 and F7 Voltage Range configuration using bootloader	34
Table 5.	Supported memory area by Write, Read, Erase and Go Commands	34
Table 6.	STM32F03xx4/6 configuration in system memory boot mode	35
Table 7.	STM32F03xx4/6 bootloader versions	36
Table 8.	STM32F030xC configuration in system memory boot mode	37
Table 9.	STM32F030xC bootloader versions	38
Table 10.	STM32F05xxx and STM32F030x8 devices configuration in system memory boot mode	39
Table 11.	STM32F05xxx and STM32F030x8 devices bootloader versions	40
Table 12.	STM32F04xxx configuration in system memory boot mode	41
Table 13.	STM32F04xxx bootloader versions	44
Table 14.	STM32F070x6 configuration in system memory boot mode	45
Table 15.	STM32F070x6 bootloader versions	48
Table 16.	STM32F070xB configuration in system memory boot mode	49
Table 17.	STM32F070xB bootloader versions	52
Table 18.	STM32F071xx/072xx configuration in system memory boot mode	53
Table 19.	STM32F071xx/072xx bootloader versions	55
Table 20.	STM32F09xxx configuration in system memory boot mode	56
Table 21.	STM32F09xxx bootloader versions	57
Table 22.	STM32F10xxx configuration in system memory boot mode	58
Table 23.	STM32F10xxx bootloader versions	59
Table 24.	STM32F105xx/107xx configuration in system memory boot mode	61
Table 25.	STM32F105xx/107xx bootloader versions	64
Table 26.	STM32F10xxx XL-density configuration in system memory boot mode	67
Table 27.	STM32F10xxx XL-density bootloader versions	68
Table 28.	STM32F2xxxx configuration in system memory boot mode	70
Table 29.	STM32F2xxxx bootloader V2.x versions	72
Table 30.	STM32F2xxxx configuration in system memory boot mode	73
Table 31.	STM32F2xxxx bootloader V3.x versions	76
Table 32.	STM32F301xx/302x4(6/8) configuration in system memory boot mode	77
Table 33.	STM32F301xx/302x4(6/8) bootloader versions	79
Table 34.	STM32F302xB(C)/303xB(C) configuration in system memory boot mode	80
Table 35.	STM32F302xB(C)/303xB(C) bootloader versions	82
Table 36.	STM32F302xD(E)/303xD(E) configuration in system memory boot mode	83
Table 37.	STM32F302xD(E)/303xD(E) bootloader versions	86
Table 38.	STM32F303x4(6/8)/334xx/328xx configuration in system memory boot mode	87
Table 39.	STM32F303x4(6/8)/334xx/328xx bootloader versions	88
Table 40.	STM32F318xx configuration in system memory boot mode	89
Table 41.	STM32F318xx bootloader versions	91
Table 42.	STM32F358xx configuration in system memory boot mode	92
Table 43.	STM32F358xx bootloader versions	93
Table 44.	STM32F373xx configuration in system memory boot mode	94
Table 45.	STM32F373xx bootloader versions	96
Table 46.	STM32F378xx configuration in system memory boot mode	97
Table 47.	STM32F378xx bootloader versions	98
Table 48.	STM32F398xx configuration in system memory boot mode	99

Table 49.	STM32F398xx bootloader versions	100
Table 50.	STM32F40xxx/41xxx configuration in system memory boot mode.	101
Table 51.	STM32F40xxx/41xxx bootloader V3.x versions	104
Table 52.	STM32F40xxx/41xxx configuration in system memory boot mode.	105
Table 53.	STM32F40xxx/41xxx bootloader V9.x versions	110
Table 54.	STM32F401xB(C) configuration in system memory boot mode	111
Table 55.	STM32F401xB(C) bootloader versions	116
Table 56.	STM32F401xD(E) configuration in system memory boot mode	117
Table 57.	STM32F401xD(E) bootloader versions	121
Table 58.	STM32F410xx configuration in system memory boot mode.	122
Table 59.	STM32F410xx bootloader V11.x versions	126
Table 60.	STM32F411xx configuration in system memory boot mode.	127
Table 61.	STM32F411xx bootloader versions	132
Table 62.	STM32F412xx configuration in system memory boot mode.	133
Table 63.	STM32F412xx bootloader V9.x versions	138
Table 64.	STM32F413xx/423xx configuration in system memory boot mode	139
Table 65.	STM32F413xx/423xx bootloader V9.x versions	144
Table 66.	STM32F42xxx/43xxx configuration in system memory boot mode.	145
Table 67.	STM32F42xxx/43xxx bootloader V7.x versions	149
Table 68.	STM32F42xxx/43xxx configuration in system memory boot mode.	150
Table 69.	STM32F42xxx/43xxx bootloader V9.x versions	156
Table 70.	STM32F446xx configuration in system memory boot mode.	157
Table 71.	STM32F446xx bootloader V9.x versions	162
Table 72.	STM32F469xx/479xx configuration in system memory boot mode	163
Table 73.	STM32F469xx/479xx bootloader V9.x versions	169
Table 74.	STM32F72xxx/73xxx configuration in system memory boot mode.	170
Table 75.	STM32F72xxx/73xxx bootloader V9.x versions	175
Table 76.	STM32F74xxx/75xxx configuration in system memory boot mode.	177
Table 77.	STM32F74xxx/75xxx bootloader V7.x versions	180
Table 78.	STM32F74xxx/75xxx configuration in system memory boot mode.	181
Table 79.	STM32F74xxx/75xxx bootloader V9.x versions	186
Table 80.	STM32F76xxx/77xxx configuration in system memory boot mode.	187
Table 81.	STM32F76xxx/77xxx bootloader V9.x versions	193
Table 82.	STM32G03xxx/G04xxx configuration in system memory boot mode	194
Table 83.	STM32G03xx/04xxx bootloader versions	197
Table 84.	STM32G07xxx/8xxx configuration in system memory boot mode	199
Table 85.	STM32G07xx/08xxx bootloader versions	202
Table 86.	STM32G431xx/441xx configuration in system memory boot mode	203
Table 87.	STM32G431xx/441xx bootloader version.	208
Table 88.	STM32G47xxx/48xxx configuration in system memory boot mode	209
Table 89.	STM32G47xxx/48xxx bootloader version	214
Table 90.	STM32H74xxx/75xxx configuration in system memory boot mode	215
Table 91.	STM32H74xxx/75xxx bootloader version	220
Table 92.	STM32L01xxx/02xxx configuration in system memory boot mode.	221
Table 93.	STM32L01xxx/02xxx bootloader versions	224
Table 94.	STM32L031xx/041xx configuration in system memory boot mode	225
Table 95.	STM32L031xx/041xx bootloader versions	227
Table 96.	STM32L05xxx/06xxx configuration in system memory boot mode.	228
Table 97.	STM32L05xxx/06xxx bootloader versions	230
Table 98.	STM32L07xxx/08xxx configuration in system memory boot mode.	231
Table 99.	STM32L07xxx/08xxx bootloader versions	234
Table 100.	STM32L07xxx/08xxx configuration in system memory boot mode.	235

Table 101.	STM32L07xxx/08xxx bootloader V11.x versions	239
Table 102.	STM32L1xxx6(8/B)A configuration in system memory boot mode	240
Table 103.	STM32L1xxx6(8/B)A bootloader versions	241
Table 104.	STM32L1xxx6(8/B) configuration in system memory boot mode	242
Table 105.	STM32L1xxx6(8/B) bootloader versions	243
Table 106.	STM32L1xxxC configuration in system memory boot mode	244
Table 107.	STM32L1xxxC bootloader versions	246
Table 108.	STM32L1xxxD configuration in system memory boot mode	247
Table 109.	STM32L1xxxD bootloader versions	250
Table 110.	STM32L1xxxE configuration in system memory boot mode	251
Table 111.	STM32L1xxxE bootloader versions	254
Table 112.	STM32L412xx/422xx configuration in system memory boot mode	255
Table 113.	STM32L412xx/422xx bootloader versions	259
Table 114.	STM32L43xxx/44xxx configuration in system memory boot mode	260
Table 115.	STM32L43xxx/44xxx bootloader versions	265
Table 116.	STM32L45xxx/46xxx configuration in system memory boot mode	266
Table 117.	STM32L45xxx/46xxx bootloader versions	271
Table 118.	STM32L47xxx/48xxx configuration in system memory boot mode	272
Table 119.	STM32L47xxx/48xxx bootloader V10.x versions	277
Table 120.	STM32L47xxx/48xxx configuration in system memory boot mode	278
Table 121.	STM32L47xxx/48xxx bootloader V9.x versions	283
Table 122.	STM32L496xx/4A6xx configuration in system memory boot mode	284
Table 123.	STM32L496xx/4A6xx bootloader version	289
Table 124.	STM32L4Rxxx/4Sxxx configuration in system memory boot mode	290
Table 125.	STM32L4Rxx/4Sxx bootloader versions	296
Table 126.	STM32L552xx/562xx configuration in system memory boot mode	297
Table 127.	STM32L552xx/562xx bootloader versions	301
Table 128.	STM32WB50xx/55xx configuration in system memory boot mode	302
Table 129.	STM32WB50xx/55xx bootloader versions	306
Table 130.	Bootloader device-dependent parameters	307
Table 131.	Bootloader startup timings of STM32 devices	310
Table 132.	USART bootloader minimum timings of STM32 devices	313
Table 133.	USB bootloader minimum timings of STM32 devices	316
Table 134.	I2C bootloader minimum timings of STM32 devices	318
Table 135.	SPI bootloader minimum timings of STM32 devices	320
Table 136.	Document revision history	321

List of figures

Figure 1.	USART Connection	31
Figure 2.	USB Connection	31
Figure 3.	I2C Connection	32
Figure 4.	SPI Connection	32
Figure 5.	CAN Connection	33
Figure 6.	Bootloader selection for STM32F03xx4/6 devices	36
Figure 7.	Bootloader selection for STM32F030xC	38
Figure 8.	Bootloader selection for STM32F05xxx and STM32F030x8 devices	40
Figure 9.	Bootloader selection for STM32F04xxx	43
Figure 10.	Bootloader selection for STM32F070x6	47
Figure 11.	Bootloader selection for STM32F070xB	51
Figure 12.	Bootloader selection for STM32F071xx/072xx	55
Figure 13.	Bootloader selection for STM32F09xxx	57
Figure 14.	Bootloader selection for STM32F10xxx	59
Figure 15.	Bootloader selection for STM32F105xx/107xx devices	63
Figure 16.	Bootloader selection for STM32F10xxx XL-density devices	68
Figure 17.	Bootloader V2.x selection for STM32F2xxxx devices	71
Figure 18.	Bootloader V3.x selection for STM32F2xxxx devices	75
Figure 19.	Bootloader selection for STM32F301xx/302x4(6/8)	79
Figure 20.	Bootloader selection for STM32F302xB(C)/303xB(C) devices	82
Figure 21.	Bootloader selection for STM32F302xD(E)/303xD(E)	85
Figure 22.	Bootloader selection for STM32F303x4(6/8)/334xx/328xx	88
Figure 23.	Bootloader selection for STM32F318xx	90
Figure 24.	Bootloader selection for STM32F358xx devices	93
Figure 25.	Bootloader selection for STM32F373xx devices	96
Figure 26.	Bootloader selection for STM32F378xx devices	98
Figure 27.	Bootloader selection for STM32F398xx	100
Figure 28.	Bootloader V3.x selection for STM32F40xxx/41xxx devices	103
Figure 29.	Bootloader V9.x selection for STM32F40xxx/41xxx	109
Figure 30.	Bootloader selection for STM32F401xB(C)	115
Figure 31.	Bootloader selection for STM32F401xD(E)	120
Figure 32.	Bootloader V11.x selection for STM32F410xx	125
Figure 33.	Bootloader selection for STM32F411xx	131
Figure 34.	Bootloader V9.x selection for STM32F412xx	137
Figure 35.	Bootloader V9.x selection for STM32F413xx/423xx	143
Figure 36.	Dual Bank Boot Implementation for STM32F42xxx/43xxx Bootloader V7.x	147
Figure 37.	Bootloader V7.x selection for STM32F42xxx/43xxx	148
Figure 38.	Dual Bank Boot Implementation for STM32F42xxx/43xxx bootloader V9.x	154
Figure 39.	Bootloader V9.x selection for STM32F42xxx/43xxx	155
Figure 40.	Bootloader V9.x selection for STM32F446xx	161
Figure 41.	Dual Bank Boot Implementation for STM32F469xx/479xx Bootloader V9.x	167
Figure 42.	Bootloader V9.x selection for STM32F469xx/479xx	168
Figure 43.	Bootloader V9.x selection for STM32F72xxx/73xxx	174
Figure 44.	Bootloader V7.x selection for STM32F74xxx/75xxx	179
Figure 45.	Bootloader V9.x selection for STM32F74xxx/75xxx	185
Figure 46.	Dual Bank Boot Implementation for STM32F76xxx/77xxx Bootloader V9.x	191
Figure 47.	Bootloader V9.x selection for STM32F76xxx/77xxx	192
Figure 48.	Access to securable memory area from the bootloader for STM32G03xxx/G04xxx	196

Figure 49.	Bootloader V5.x selection for STM32G03xxx/G04xxx	197
Figure 50.	Access to securable memory area from the bootloader for STM32G07xxx/G08xxx	201
Figure 51.	Bootloader V11.0 selection for STM32G07xxx/G08xxx	202
Figure 52.	Access to securable memory area	206
Figure 53.	Bootloader selection for STM32G431xx/441xx	207
Figure 54.	Access to securable memory area	212
Figure 55.	Bootloader selection for STM32G47xxx/48xxx	213
Figure 56.	Dual bank boot implementation for STM32G47xxx/48xxx bootloader V13.x	214
Figure 57.	Bootloader V9.x selection for STM32H74xxx/75xxx	219
Figure 58.	Bootloader selection for STM32L01xxx/02xxx	223
Figure 59.	Bootloader selection for STM32L031xx/041xx	227
Figure 60.	Bootloader selection for STM32L05xxx/06xxx	230
Figure 61.	Dual Bank Boot Implementation for STM32L07xxx/08xxx bootloader V4.x	233
Figure 62.	Bootloader V4.x selection for STM32L07xxx/08xxx	234
Figure 63.	Dual Bank Boot Implementation for STM32L07xxx/08xxx bootloader V11.x	237
Figure 64.	Bootloader V11.x selection for STM32L07xxx/08xxx	238
Figure 65.	Bootloader selection for STM32L1xxx6(8/B)A devices	241
Figure 66.	Bootloader selection for STM32L1xxx6(8/B) devices	243
Figure 67.	Bootloader selection for STM32L1xxx C devices	246
Figure 68.	Bootloader selection for STM32L1xxx D devices	249
Figure 69.	Bootloader selection for STM32L1xxx E devices	253
Figure 70.	Bootloader V13.x selection for STM32L412xx/422xx	258
Figure 71.	Bootloader V9.x selection for STM32L43xxx/44xxx	264
Figure 72.	Bootloader V9.x selection for STM32L45xxx/46xxx	270
Figure 73.	Dual Bank Boot Implementation for STM32L47xxx/48xxx bootloader V10.x	275
Figure 74.	Bootloader V10.x selection for STM32L47xxx/48xxx	276
Figure 75.	Dual Bank Boot Implementation for STM32L47xxx/48xxx bootloader V9.x	281
Figure 76.	Bootloader V9.x selection for STM32L47xxx/48xxx	282
Figure 77.	Bootloader V9.x selection for STM32L496xx/4A6xx	288
Figure 78.	Dual bank boot implementation for STM32L4Rxxx/STM32L4Sxxx bootloader V9.x	294
Figure 79.	Bootloader V9.x selection for STM32L4Rxx/4Sxx	295
Figure 80.	Bootloader V9.x selection for STM32L552xx/562xx	300
Figure 81.	Bootloader V13.0 selection for STM32WB50xx/55xx	305
Figure 82.	Bootloader Startup timing description	310
Figure 83.	USART connection timing description	313
Figure 84.	USB connection timing description	316
Figure 85.	I2C connection timing description	318
Figure 86.	SPI connection timing description	320

1 General information

This document applied to Arm®-based devices.



Note: Arm is a registered trademark of Arm Limited (or its subsidiaries) in the US and/or elsewhere

2 Related documents

For each supported product (listed in [Table 1](#)), please refer to the following documents available from www.st.com:

- Datasheet or databrief
- Reference manual
- Application Note:
 - AN3154: CAN protocol used in the STM32 bootloader
 - AN3155: USART protocol used in the STM32 bootloader
 - AN3156: USB DFU protocol used in the STM32 bootloader
 - AN4221: I2C protocol used in the STM32 bootloader
 - AN4286: SPI protocol used in the STM32 bootloader

3 Glossary

F0 Series:

STM32F03xxx is used to refer to STM32F030x4, STM32F030x6, STM32F038x6, STM32F030xC, STM32F031x4 and STM32F031x6 devices.

STM32F04xxx is used to refer to STM32F042x4 and STM32F042x6 devices.

STM32F05xxx and STM32F030x8 devices is used to refer to STM32F051x4, STM32F051x6, STM32F051x8, STM32F058x8 and STM32F030x8 devices.

STM32F07xxx is used to refer to STM32F070x6, STM32F070xB, STM32F071xB, STM32F072x8 and STM32F072xB devices.

STM32F09xxx is used to refer to STM32F091xx and STM32F098xx devices.

F1 Series:

STM32F10xxx is used to refer to Low-density, Medium-density, High-density, Low-density value line, Medium-density value line and High-density value line devices:

Low-density devices are STM32F101xx, STM32F102xx and STM32F103xx microcontrollers where the Flash memory density ranges between 16 and 32 Kbyte.

Medium-density devices are STM32F101xx, STM32F102xx and STM32F103xx microcontrollers where the Flash memory density ranges between 64 and 128 Kbyte.

High-density devices are STM32F101xx and STM32F103xx microcontrollers where the Flash memory density ranges between 256 and 512 Kbyte.

Low-density value line devices are STM32F100xx microcontrollers where the Flash memory density ranges between 16 and 32 Kbyte.

Medium-density value line devices are STM32F100xx microcontrollers where the Flash memory density ranges between 64 and 128 Kbyte.

High-density value line devices are STM32F100xx microcontrollers where the Flash memory density ranges between 256 and 512 Kbyte.

STM32F105xx/107xx is used to refer to STM32F105xx and STM32F107xx devices.

STM32F10xxx XL-density is used to refer to STM32F101xx and STM32F103xx devices where the Flash memory density ranges between 768 Kbyte and 1 Mbyte.

F2 Series:

STM32F2xxxx is used to refer to STM32F215xx, STM32F205xx, STM32F207xx and STM32F217xx devices.

F3 Series:

STM32F301xx/302x4(6/8) is used to refer to STM32F301x4, STM32F301x6, STM32F301x8, STM32F302x4, STM32F302x6 and STM32F302x8 devices.

STM32F302xB(C)/303xB(C) is used to refer to STM32F302xB, STM32F302xC, STM32F303xB and STM32F303xC devices.

STM32F302xD(E)/303xD(E) is used to refer to STM32F302xD, STM32F302xE, STM32F303xD and STM32F303xE devices.

STM32F303x4(6/8)/334xx/328xx is used to refer to STM32F303x4, STM32F303x6, STM32F303x8, STM32F334x4, STM32F334x6, STM32F334x8, and STM32F328x8 devices.

STM32F318xx is used to refer to STM32F318x8 devices.

STM32F358xx is used to refer to STM32F358xC devices.

STM32F373xx is used to refer to STM32F373x8, STM32F373xB and STM32F373xC devices.

STM32F378xx is used to refer to STM32F378xC devices.

STM32F398xx is used to refer to STM32F398xE devices.

F4 Series:

STM32F40xxx/41xxx is used to refer to STM32F405xx, STM32F407xx, STM32F415xx and STM32F417xx devices.

STM32F401xB(C) is used to refer to STM32F401xB and STM32F401xC devices.

STM32F401xD(E) is used to refer to STM32F401xD and STM32F401xE devices.

STM32F410xx is used to refer to STM32F410x8 and STM32F410xB devices.

STM32F411xx is used to refer to STM32F411xD and STM32F411xE devices.

STM32F412xx is used to refer to STM32F412Cx, STM32F412Rx, STM32F412Vx and STM32F412Zx devices.

STM32F413xx/423xx is used to refer to STM32F413xG, STM32F413xH and STM32F423xH devices.

STM32F42xxx/43xxx is used to refer to STM32F427xx, STM32F429xx, STM32F437xx and STM32F439xx devices.

STM32F446xx is used to refer to STM32F446xE and STM32F446xC devices.

STM32F469xx/479xx is used to refer to STM32F469xE, STM32F469xG, STM32F469xI, STM32F479xG and STM32F479xI devices.

F7 Series:

STM32F72xxx/73xxx is used to refer to STM32F722xx, STM32F723xx, STM32F732xx and STM32F733xx devices.

STM32F74xxx/75xxx is used to refer to STM32F745xx, STM32F746xx and STM32F756xx devices.

STM32F76xxx/77xxx is used to refer to STM32F765xx, STM32F767xx, STM32F769xx, STM32F777xx and STM32F779xx devices.

G0 Series:

STM32G03xxx/04xxx is used to refer to STM32G03xxx and STM32G04xxx devices.

STM32G07xxx/08xxx is used to refer to STM32G07xxx and STM32G08xxx devices.

G4 Series:

STM32G431xx is used to refer to STM32G431xx devices.

STM32G441xx is used to refer to STM32G441xx devices.

STM32G47xxx is used to refer to STM32G471xx, STM32G473xx and STM32G474xx devices.

STM32G48xxx is used to refer to STM32G483xx and STM32G484xx devices.

H7 Series:

STM32H74xxx/75xxx is used to refer to STM32H743xx and STM32H753xx devices.

L0 Series:

STM32L01xxx/02xxx is used to refer to STM32L011xx and STM32L021xx devices.

STM32L031xx/041xx is used to refer to STM32L031xx and STM32L041xx devices.

STM32L05xxx/06xxx is used to refer to STM32L051xx, STM32L052xx, STM32L053xx, STM32L062xx and STM32L063xx ultralow power devices.

STM32L07xxx/08xxx is used to refer to STM32L071xx, STM32L072xx, STM32L073xx, STM32L081xx, STM32L082xx and STM32L083xx devices

L1 Series:

STM32L1xxx6(8/B) is used to refer to STM32L1xxV6T6, STM32L1xxV6H6, STM32L1xxR6T6, STM32L1xxR6H6, STM32L1xxC6T6, STM32L1xxC6H6, STM32L1xxV8T6, STM32L1xxV8H6, STM32L1xxR8T6, STM32L1xxR8H6, STM32L1xxC8T6, STM32L1xxC8H6, STM32L1xxVBT6, STM32L1xxVBH6, STM32L1xxRBT6, STM32L1xxRBH6, STM32L1xxCBT6 and STM32L1xxCBH6 ultralow power devices.

STM32L1xxx6(8/B)A is used to refer to STM32L1xxV6T6-A, STM32L1xxV6H6-A, STM32L1xxR6T6-A, STM32L1xxR6H6-A, STM32L1xxC6T6-A, STM32L1xxC6H6-A, STM32L1xxV8T6-A, STM32L1xxV8H6-A, STM32L1xxR8T6-A, STM32L1xxR8H6-A, STM32L1xxC8T6-A, STM32L1xxC8H6-A, STM32L1xxVBT6-A, STM32L1xxVBH6-A, STM32L1xxRBT6-A, STM32L1xxRBH6-A, STM32L1xxCBT6-A and STM32L1xxCBH6-A ultralow power devices.

STM32L1xxxC is used to refer to STM32L1xxVCT6, STM32L1xxVCH6, STM32L1xxRCT6, STM32L1xxUCY6, STM32L1xxCCT6 and STM32L1xxCCU6 ultralow power devices.

STM32L1xxxD is used to refer to STM32L1xxZDT6, STM32L1xxQDH6, STM32L1xxVDT6, STM32L1xxRDY6, STM32L1xxRDT6, STM32L1xxZCT6, STM32L1xxQCH6, STM32L1xxRCY6, STM32L1xxVCT6-A and STM32L1xxRCT6-A ultralow power devices.

STM32L1xxxE is used to refer to STM32L1xxZET6, STM32L1xxQEH6, STM32L1xxVET6, STM32L1xxVEY6, and STM32L1xxRET6 ultralow power devices.

L4 Series:

STM32L412xx/422xx is used to refer to STM32L412xB, STM32L412x8, STM32L422xB devices.

STM32L43xxx/44xxx is used to refer to STM32L431xx, STM32L432xx, STM32L433xx and STM32L442xx and STM32L443xx devices.

STM32L45xxx/46xxx is used to refer to STM32L451xx, STM32L452xx and STM32L462xx devices.

STM32L47xxx/48xxx is used to refer to STM32L471xx, STM32L475xx, STM32L476xx and STM32L486xx devices.

STM32L496xx/4A6xx is used to refer to STM32L496xE, STM32L496xG and STM32L4A6xG devices.

STM32L4Rxxx/4Sxxx is used to refer to STM32L4R5xx, STM32L4R7xx, STM32L4R9xx, STM32L4S5xx, STM32L4S7xx and STM32L4S9xx devices.

L5 Series:

STM32L552xx is used to refer to STM32L552xx devices.

STM32L562xx is used to refer to STM32L562xx devices.

WB Series:

STM32WB50xx is used to refer to STM32WB50xx devices.

STM32WB55xx is used to refer to STM32WB55Cx, STM32WB55Rx, STM32WB55Vx devices.

Note:

BL_USART_Loop refers to the USART bootloader execution loop.

BL_CAN_Loop refers to the CAN bootloader execution loop.

BL_I2C_Loop refers to the I2C bootloader execution loop.

BL_SPI_Loop refers to the SPI bootloader execution loop.

4 General bootloader description

4.1 Bootloader activation

The bootloader is activated by applying one of the patterns described in [Table 2: Bootloader activation patterns](#).

If Boot From Bank2 option is activated (for products supporting this feature), bootloader executes Dual Boot mechanism as described in figures "Dual Bank Boot Implementation for STM32xxxx" where STM32xxxx is the relative STM32 product.

Otherwise, bootloader selection protocol is executed as described in figures "Bootloader VY.x selection for STM32xxxx" where STM32xxxx is the relative STM32 product.

When readout protection Level2 is activated, STM32 does not boot on system memory in any case and bootloader can't be executed (unless jumping to it from Flash user code, all commands are not accessible except Get, GetID, and GetVersion).

Table 2. Bootloader activation patterns

Patterns	Condition
Pattern1	Boot0(pin) = 1 and Boot1(pin) = 0
Pattern2	Boot0(pin) = 1 and nBoot1(bit) = 1
Pattern3	Boot0(pin) = 1, Boot1(pin) = 0 and BFB2(bit) = 1
	Boot0(pin) = 0, BFB2(bit) = 0 and both banks don't contain valid code
	Boot0(pin) = 1, Boot1(pin) = 0, BFB2(bit) = 0 and both banks don't contain valid code
Pattern4	Boot0(pin) = 1, Boot1(pin) = 0 and BFB2(bit) = 1
	Boot0(pin) = 0, BFB2(bit) = 0 and both banks don't contain valid code
	Boot0(pin) = 1, Boot1(pin) = 0 and BFB2(bit) = 0
Pattern5	Boot0(pin) = 1, Boot1(pin) = 0 and BFB2(bit) = 0
	Boot0(pin) = 0, BFB2(bit) = 1 and both banks don't contain valid code
	Boot0(pin) = 1, Boot1(pin) = 0 and BFB2 (bit) = 1
Pattern6	Boot0(pin) = 1, nBoot1(bit) = 1 and nBoot0_SW(bit) = 1
	nBoot0(bit) = 0, nBoot1(bit) = 1 and nBoot0_SW(bit) = 0
	Boot0(pin) = 0, nBoot0_SW(bit) = 1 and main flash empty
	nBoot0(bit) = 1, nBoot0_SW(bit)=0 and main flash empty
Pattern7	Boot0(pin) = 1, nBoot1(bit) = 1 and BFB2(bit) = 0
	Boot0(pin) = 0, BFB2(bit) = 1 and both banks don't contain valid code
	Boot0(pin) = 1, nBoot1(bit) = 1 and BFB2(bit) = 1
Pattern8	Boot(pin) = 0 and BOOT_ADD0(optionbyte) = 0x0040
	Boot(pin) = 1 and BOOT_ADD1(optionbyte) = 0x0040

Table 2. Bootloader activation patterns (continued)

Patterns	Condition
Pattern9	nDBANK(bit) = 1, Boot(pin) = 0 and BOOT_ADD0(optionbyte) = 0x0040
	nDBANK(bit) = 1, Boot(pin) = 1 and BOOT_ADD1(optionbyte) = 0x0040
	nDBANK(bit) = 0, nDBOOT(bit) = 1, Boot(pin) = 0 and BOOT_ADD0(optionbyte) = 0x0040
	nDBANK(bit) = 0, nDBOOT(bit) = 1, Boot(pin) = 1 and BOOT_ADD1(optionbyte) = 0x0040
	nDBANK(bit) = 0, nDBOOT(bit) = 0, BOOT_ADDx(optionbyte) out of memory range or in ICP memory range
	nDBANK(bit) = 0, nDBOOT(bit) = 0, BOOT_ADDx(optionbyte) in Flash memory range and both banks don't contain valid code
Pattern10	Boot(pin) = 0 and BOOT_ADD0(optionbyte) = 0x1FF0
	Boot(pin) = 1 and BOOT_ADD1(optionbyte) = 0x1FF0
Patten 11	nBoot0(bit) = 0, nBoot1(bit) = 1, USE_BOOT0_OPT(bit) = 1 and BOOT_EP(bit) = 0
	Boot0(pin) = 1, nBoot1(bit) = 1 and USE_BOOT0_OPT (bit) = 1
	nBoot0(bit) = 1, USE_BOOT0_OPT(bit) = 1, BOOT_EP(bit) = 0 and main Flash memory empty
	Boot0(pin) = 0, USE_BOOT0_OPT(bit) = 0, BOOT_EP(bit) = 0 and main Flash memory empty
	BOOT_EP(bit) = 1 and main flash empty
Pattern 12	TZen = 0, Boot0(pin) = 0, nSWBoot0(bit) = 1 and NSBOOTADD0 [24:0] = 0x017F200
	TZen = 0, Boot0(pin) = 1, nSWBoot0 (bit) = 1 and NSBOOTADD1 [24:0] = 0x017F200
	TZen = 0, nBoot0(bit) = 0, nSWBoot0 (bit) = 0 and NSBOOTADD1 [24:0] = 0x017F200
	TZen = 0, nBoot0(bit) = 1, nSWBoot0 (bit) = 0 and NSBOOTADD0 [24:0] = 0x017F200
	TZen = 1, Boot0(pin) = 0, nSWBoot0 (bit) = 1 and SECBOOTADD0 [24:0] = 0x01FF000 & RSSCMD = 0
	TZen = 1, Boot0(pin) = 1, nSWBoot0 (bit) = 1 & RSSCMD = 0, BOOT_LOCK=0 or (BOOT_LOCK = 1 and SECBOOTADD0 [24:0] = 0x01FF000)
	TZen = 1, nBoot0(bit) = 1, nSWBoot0 (bit) = 0 and SECBOOTADD0 [24:0] = 0x01FF000 & RSSCMD = 0, BOOT_LOCK=0 or (BOOT_LOCK = 1 and SECBOOTADD0 [24:0] = 0x01FF000)
	TZen = 1, nBoot0(bit) = 0, nSWBoot0 (bit) = 0 & RSSCMD = 0, BOOT_LOCK=0 or BOOT_LOCK = 1 and SECBOOTADD1 [24:0] = 0x01FF000
	TZen = 1, RSSCMD = 0x1C0, BOOT_LOCK=0 or (BOOT_LOCK = 1 and SECBOOTADD0 [24:0] = 0x01FF000)

In addition to patterns described above, user can execute bootloader by performing a jump to system memory from user code. Before jumping to bootloader user must:

- Disable all peripheral clocks
- Disable used PLL
- Disable interrupts
- Clear pending interrupts

System memory boot mode can be exited by getting out from bootloader activation condition and generating hardware reset or using Go command to execute user code.

Note: If you choose to execute the Go command, the peripheral registers used by the bootloader are not initialized to their default reset values before jumping to the user application. They should be reconfigured in the user application if they are used. So, if the IWDG is being used in the application, the IWDG prescaler value has to be adapted to meet the requirements of the application (since the prescaler was set to its maximum value). For some products, not all reset values are set. For more information please refer to the known limitations detailed for each product's bootloader versions.

Note: For STM32 devices having the Dual Bank Boot feature, in order to jump to system memory from user code, the user has first to remap the System Memory bootloader at address 0x00000000 using SYSCFG register (except for STM32F7 series), then jump to bootloader. For STM32F7 series, the user has to disable nDBOOT and/or nDBANK features (in option bytes), then jump to bootloader.

Note: For STM32 devices embedding bootloader using the DFU/CAN interface in which the external clock source (HSE) is required for DFU/CAN operations, the detection of the HSE value is done dynamically by the bootloader firmware and is based on the internal oscillator clock (HSI, MSI). Thus, when due to temperature or other conditions, the internal oscillator precision is altered above the tolerance band (1% around the theoretical value), the bootloader might calculate a wrong HSE frequency value. In this case, the bootloader DFU/CAN interfaces might dysfunction or might not work at all.

4.2 Bootloader identification

Depending on the STM32 device used, the bootloader may support one or more embedded serial peripherals used to download the code to the internal Flash memory. The bootloader identifier (ID) provides information about the supported serial peripherals.

For a given STM32 device, the bootloader is identified by means of the:

1. **Bootloader (protocol) version:** version of the serial peripheral (USART, CAN, USB, etc.) communication protocol used in the bootloader. This version can be retrieved using the bootloader Get Version command.
2. **Bootloader identifier (ID):** version of the STM32 device bootloader, coded on one byte in the **0xXY** format, where:
 - **X** specifies the embedded serial peripheral(s) used by the device bootloader:
 - X = 1: one USART is used
 - X = 2: two USARTs are used
 - X = 3: USART, CAN and DFU are used
 - X = 4: USART and DFU are used
 - X = 5: USART and I²C are used
 - X = 6: I²C is used

- X = 7: USART, CAN, DFU and I²C are used
- X = 8: I²C and SPI are used
- X = 9: USART, CAN (or FDCAN), DFU, I²C and SPI are used
- X = 10: USART, DFU and I²C are used
- X = 11: USART, I²C and SPI are used
- X = 12: USART and SPI are used
- X = 13: USART, DFU, I²C and SPI are used

- Y specifies the device bootloader version

Let us take the example of a bootloader ID equal to 0x10. This means that it is the first version of the device bootloader that uses only one USART.

The bootloader ID is programmed in the last byte address - 1 of the device system memory and can be read by using the bootloader "Read memory" command or by direct access to the system memory via JTAG/SWD.

Note: The bootloader ID format is applied to all STM32 devices families except the STM32F1xx family. The bootloader version for the STM32F1xx applies only to the embedded device's bootloader version and not to its supported protocols.

The table below provides identification information about the bootloaders embedded in STM32 devices.

Table 3. Embedded bootloaders

STM32 series	Device	Supported serial peripherals	Bootloader ID		Bootloader (protocol) version
			ID	Memory location	
F0	STM32F05xxx/STM32F030x8 devices	USART1/USART2	0x21	0x1FFFF7A6	USART (V3.1)
	STM32F03xx4/6	USART1	0x10	0x1FFFF7A6	USART (V3.1)
	STM32F030xC	USART1/I2C1	0x52	0x1FFFF796	USART (V3.1) I2C1(V1.0)
	STM32F04xxx	USART1/USART2/ I2C1/ DFU (USB Device FS)	0xA1	0x1FFFF6A6	USART (V3.1) DFU (V2.2) I2C (V1.0)
	STM32F071xx/072xx	USART1/USART2/ I2C1/ DFU (USB Device FS)	0xA1	0x1FFFF6A6	USART (V3.1) DFU (V2.2) I2C (V1.0)
F0	STM32F070x6	USART1/USART2/ DFU (USB Device FS)/I2C1	0xA2	0x1FFFF6A6	USART (V3.1) DFU (V2.2) I2C (V1.0)
	STM32F070xB	USART1/USART2/ DFU (USB Device FS)/I2C1	0xA3	0x1FFFF6A6	USART (V3.1) DFU (V2.2) I2C (V1.0)
	STM32F09xxx	USART1/USART2/ I2C1	0x50	0x1FFFF796	USART (V3.1) I2C (V1.0)

Table 3. Embedded bootloaders (continued)

STM32 series	Device		Supported serial peripherals	Bootloader ID		Bootloader (protocol) version
				ID	Memory location	
F1	STM32F10xx	Low-density	USART1	NA	NA	USART (V2.2)
		Medium-density	USART1	NA	NA	USART (V2.2)
		High-density	USART1	NA	NA	USART (V2.2)
		Medium-density value line	USART1	0x10	0x1FFFF7D6	USART (V2.2)
		High-density value line	USART1	0x10	0x1FFFF7D6	USART (V2.2)
	STM32F105xx/107xx		USART1 / USART2 (remapped) / CAN2 (remapped) / DFU (USB Device)	NA	NA	USART (V2.2 ⁽¹⁾) CAN (V2.0) DFU(V2.2)
	STM32F10xxx XL-density		USART1/USART2 (remapped)	0x21	0x1FFFF7D6	USART (V3.0)
F2	STM32F2xxx		USART1/USART3	0x20	0x1FFF77DE	USART (V3.0)
			USART1/USART3/ CAN2/ DFU (USB Device FS)	0x33	0x1FFF77DE	USART (V3.1) CAN (V2.0) DFU (V2.2)
F3	STM32F373xx		USART1/USART2/ DFU (USB Device FS)	0x41	0x1FFFF7A6	USART (V3.1) DFU (V2.2)
	STM32F378xx		USART1/USART2/ I2C1	0x50	0x1FFFF7A6	USART (V3.1) I2C (V1.0)
	STM32F302xB(C)/303xB(C)		USART1/USART2/ DFU (USB Device FS)	0x41	0x1FFFF796	USART (V3.1) DFU (V2.2)
	STM32F358xx		USART1/USART2/ I2C1	0x50	0x1FFFF796	USART (V3.1) I2C (V1.0)
	STM32F301xx/302x4(6/8)		USART1/USART2/ DFU (USB Device FS)	0x40	0x1FFFF796	USART (V3.1) DFU (V2.2)
	STM32F318xx		USART1/USART2/ I2C1/ I2C3	0x50	0x1FFFF796	USART (V3.1) I2C (V1.0)
	STM32F302xD(E)/303xD(E)		USART1/USART2/ DFU (USB Device FS)	0x40	0x1FFFF796	USART (V3.1) DFU (V2.2)
	STM32F303x4(6/8)/334xx/328xx		USART1/USART2/ I2C1	0x50	0x1FFFF796	USART (V3.1) I2C (V1.0)
	STM32F398xx		USART1/USART2/ I2C1/I2C3	0x50	0x1FFFF796	USART (V3.1) I2C (V1.0)

Table 3. Embedded bootloaders (continued)

STM32 series	Device	Supported serial peripherals	Bootloader ID		Bootloader (protocol) version
			ID	Memory location	
F4	STM32F40xxx/41xxx	USART1/USART3/ CAN2/ DFU (USB Device FS)	0x31	0x1FFF77DE	USART (V3.1) CAN (V2.0) DFU (V2.2)
		USART1/USART3/ CAN2 / DFU (USB Device FS) / I2C1/I2C2/I2C3/SPI1/SPI2	0x90	0x1FFF77DE	USART (V3.1) CAN (V2.0) DFU (V2.2) SPI(V1.1) I2C (V1.0)
	STM32F42xxx/43xxx	USART1/USART3/ CAN2 / DFU (USB Device FS) / I2C1	0x70	0x1FFF76DE	USART (V3.1) CAN (V2.0) DFU (V2.2) I2C (V1.0)
		USART1/USART3/ CAN2 / DFU (USB Device FS) / I2C1/I2C2/I2C3/SPI1/ SPI2/ SPI4	0x91	0x1FFF76DE	USART (V3.1) CAN (V2.0) DFU (V2.2) SPI(V1.1) I2C (V1.0)
	STM32F401xB(C)	USART1/USART2/ DFU (USB Device FS) / I2C1/I2C2/I2C3/ SPI1/SPI2/ SPI3	0xD1	0x1FFF76DE	USART (V3.1) DFU (V2.2) SPI(V1.1) I2C (V1.0)
	STM32F401xD(E)	USART1/USART2/ DFU (USB Device FS) / I2C1/I2C2/I2C3/ SPI1/SPI2/ SPI3	0xD1	0x1FFF76DE	USART (V3.1) DFU (V2.2) SPI(V1.1) I2C (V1.1)
	STM32F410xx	USART1/USART2/ I2C1/I2C2/I2C4 SPI1/SPI2	0xB1	0x1FFF76DE	USART (V3.1) I2C (V1.2) SPI (V1.1)
	STM32F411xx	USART1/USART2/ DFU (USB Device FS) / I2C1/I2C2/I2C3/ SPI1/SPI2/ SPI3	0xD0	0x1FFF76DE	USART (V3.1) DFU (V2.2) SPI(V1.1) I2C (V1.1)
	STM32F412xx	USART1/USART2/ USART3/CAN2/ DFU (USB Device FS)/ I2C1/I2C2/I2C3/I2C4/ SPI1/SPI3/SPI4	0x91	0x1FFF76DE	USART (V3.1) CAN (V2.0) DFU (V2.2) SPI (V1.1) I2C (V1.2)
	STM32F413xx/423xx	USART1/USART2/ USART3/CAN2/ DFU (USB Device FS)/ I2C1/I2C2/I2C3/I2C4/ SPI1/SPI3/SPI4	0x90	0x1FFF76DE	USART (V3.1) CAN (V2.0) DFU (V2.2) I2C (V1.2) SPI (V1.1)
	STM32F446xx	USART1/USART3/ CAN2 / DFU (USB Device FS) / I2C1/I2C2/I2C3/SPI1/ SPI2/ SPI4	0x90	0x1FFF76DE	USART (V3.1) CAN (V2.0) DFU (V2.2) SPI(V1.1) I2C (V1.2)

Table 3. Embedded bootloaders (continued)

STM32 series	Device	Supported serial peripherals	Bootloader ID		Bootloader (protocol) version
			ID	Memory location	
F4	STM32F469xx/479xx	USART1/USART3/ I2C1/I2C2/I2C3/ CAN2/ DFU (USB Device FS)/ SPI1/ SPI2/ SPI4	0x90	0x1FFF76DE	USART (V3.1) I2C (V1.2) CAN (V2.0) DFU (V2.2) SPI (V1.1)
F7	STM32F72xxx/73xxx	USART1/USART3/ CAN1/ DFU (USB Device FS)/ I2C1/I2C2/I2C3/ SPI1/SPI2/SPI4	0x90	0x1FF0EDBE	USART (V3.1) CAN (V2.0) DFU (V2.2) I2C (V1.2) SPI (V1.2)
	STM32F74xxx/75xxx	USART1/USART3/ I2C1/I2C2/I2C3/ CAN2/ DFU (USB Device FS)	0x70	0x1FF0EDBE	USART (V3.1) I2C (V1.2) CAN (V2.0) DFU (V2.2)
		USART1/USART3/ I2C1/I2C2/I2C3/ CAN2/ DFU (USB Device FS)/ SPI1/SPI2/SPI4	0x90	0x1FF0EDBE	USART (V3.1) I2C (V1.2) CAN (V2.0) DFU (V2.2) SPI (V1.2)
	STM32F76xxx/77xxx	USART1/USART3/ CAN2/ DFU (USB Device FS)/ I2C1/I2C2/I2C3/ SPI1/SPI2/SPI4	0x93	0x1FF0EDBE	USART (V3.1) CAN (V2.0) DFU (V2.2) I2C (V1.2) SPI (V1.2)
G0	STM32G07xxx/08xxx	USART1/USART2/ USART3/I2C1/I2C2/ SPI1/SPI2	0xB2	0x1FFF6FFE	USART (V3.1) I2C (V1.2) SPI (V1.1)
	STM32G03xxx/04xxx	USART1/USART2/ I2C1/I2C2	0x53	0x1FFF1FFE	USART (V3.1) I2C (V1.2)
G4	STM32G431xx/441xx	USART1/USART2/USART3 I2C2/I2C3 SPI1/SPI2 DFU (USB Device FS)	0xD3	0x1FFF6FFE	USART (V3.1) I2C (V1.2) SPI (V1.1) DFU (V2.2)
	STM32G47xxx/48xxx	USART1/USART2/USART3 I2C2/I2C3/I2C4 SPI1/SPI2 DFU (USB Device FS)	0xD4	0x1FFF6FFE	USART (V3.1) I2C (V1.2) SPI (V1.1) DFU (V2.2)
H7	STM32H74xxx/75xxx	USART1/USART2/ USART3 I2C1/I2C2/I2C3/ DFU (USB Device FS)/ SPI1/SPI2/SPI3/SPI4/ FDCAN1	0x90	0x1FF1E7FE	USART (V3.1) I2C (V1.1) DFU (V2.2) SPI (V1.2) FDCAN (V1.0)

Table 3. Embedded bootloaders (continued)

STM32 series	Device	Supported serial peripherals	Bootloader ID		Bootloader (protocol) version
			ID	Memory location	
L0	STM32L01xxx/02xxx	USART2/SPI1	0xC3	0x1FF00FFE	USART (V3.1) SPI (V1.1)
	STM32L031xx/041xx	USART2/SPI1	0xC0	0x1FF00FFE	USART (V3.1) SPI (V1.1)
	STM32L05xxx/06xxx	USART1/USART2/SPI1/ SPI2	0xC0	0x1FF00FFE	USART (V3.1) SPI (V1.1)
	STM32L07xxx/08xxx	USART1/USART2/ DFU (USB Device FS)	0x41	0x1FF01FFE	USART (V3.1) DFU (V2.2)
USART1/USART2/ SPI1/SPI2/ I2C1/I2C2		0xB2	0x1FF01FFE	USART (V3.1) SPI (V1.1) I2C (V1.2)	
L1	STM32L1xxx6(8/B)	USART1/USART2	0x20	0x1FF00FFE	USART (V3.0)
	STM32L1xxx6(8/B)A	USART1/USART2	0x20	0x1FF00FFE	USART (V3.1)
	STM32L1xxxC	USART1/USART2/ DFU (USB Device FS)	0x40	0x1FF01FFE	USART (V3.1) DFU (V2.2)
	STM32L1xxxD	USART1/USART2/ DFU (USB Device FS)	0x45	0x1FF01FFE	USART (V3.1) DFU (V2.2)
	STM32L1xxxE	USART1/USART2/ DFU (USB Device FS)	0x40	0x1FF01FFE	USART (V3.1) DFU (V2.2)

Table 3. Embedded bootloaders (continued)

STM32 series	Device	Supported serial peripherals	Bootloader ID		Bootloader (protocol) version
			ID	Memory location	
L4	STM32L412xx/422xx	USART1/USART2/USART3 I2C1/I2C2/I2C3/ DFU (USB Device FS)/ SPI1/SPI2	0xD1	0x1FFF6FFE	USART (V3.1) I2C (V1.2) DFU (V2.2) SPI (V1.1)
	STM32L43xxx/44xxx	USART1/USART2/USART3/ I2C1/I2C2/I2C3/ CAN1/ DFU (USB Device FS)/ SPI1/SPI2	0x91	0x1FFF6FFE	USART (V3.1) I2C (V1.2) CAN (V2.0) DFU (V2.2) SPI (V1.1)
	STM32L45xxx/46xxx	USART1/USART2/ I2C1/I2C2/I2C3/ CAN1/ DFU (USB Device FS)/ SPI1/SPI2	0x92	0x1FFF6FFE	USART (V3.1) I2C (V1.2) CAN (V2.0) DFU (V2.2) SPI (V1.1)
	STM32L47xxx/48xxx	USART1/USART2/ USART3/ I2C1/I2C2/I2C3/ DFU (USB Device FS)	0xA3	0x1FFF6FFE	USART (V3.1) I2C (V1.2) DFU (V2.2)
		USART1/USART2/ USART3/ I2C1/I2C2/I2C3/ SPI1/SPI2/CAN1/ DFU (USB Device FS)	0x92	0x1FFF6FFE	USART (V3.1) I2C (V1.2) SPI (V1.1) CAN(V2.0) DFU(V2.2)
	STM32L496xx/4A6xx	USART1/USART2/ I2C1/I2C2/I2C3/ CAN1/ DFU (USB Device FS)/ SPI1/SPI2	0x93	0x1FFF6FFE	USART (V3.1) I2C (V1.2) CAN (V2.0) DFU (V2.2) SPI (V1.1)
STM32L4Rxxx/STM32L4Sxxx	USART1/USART2/ I2C1/I2C2/I2C3/ CAN1/ DFU (USB Device FS)/ SPI1/SPI2	0x92	0x1FFF6FFE	USART (V3.1) I2C (V1.2) CAN (V2.0) DFU (V2.2) SPI (V1.1)	
L5	STM32L552xx/562xx	USART1/USART2/USART3 I2C1/I2C2/I2C3 SPI1/SPI2/SPI3 DFU (USB Device FS) FDCAN1	0x91	0x0BF97FFE	USART (V3.1) I2C (V1.2) SPI (V1.1) DFU (V2.2) FDCAN (V1.0)
WB	STM32WB50xx/55xx	USART1/ I2C1/I2C3 SPI1/SPI2 DFU (USB Device FS)	0xD5	0x1FFF6FFE	USART (V3.2) I2C (V1.2) SPI (V1.1) DFU (V2.2)

1. For connectivity line devices, the USART bootloader returns V2.0 instead of V2.2 for the protocol version. For more details please refer to the "STM32F105xx and STM32F107xx revision Z" errata sheet available from <http://www.st.com>.

4.3 Hardware connection requirements

To use the USART bootloader, the host has to be connected to the (RX) and (TX) pins of the desired USARTx interface via a serial cable.

Figure 1. USART Connection

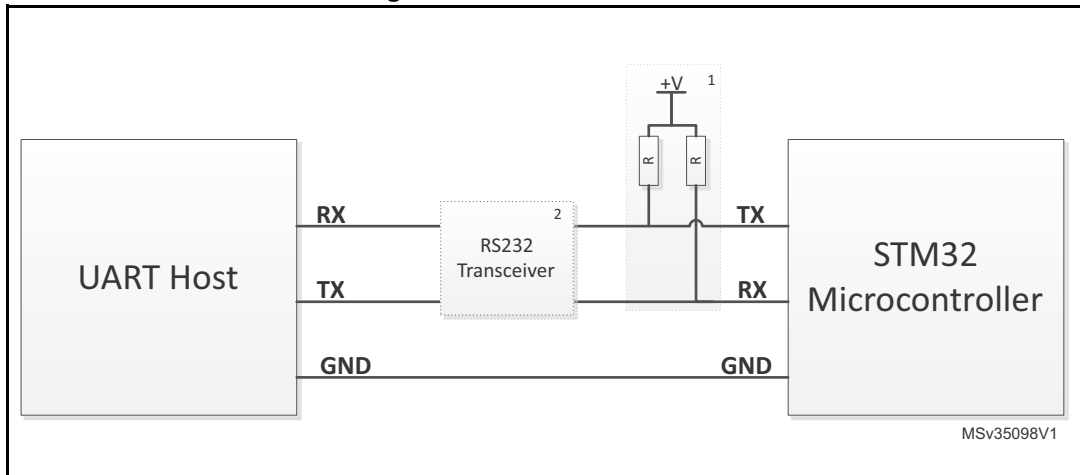

1. A Pull-UP resistor should be added, if pull-up resistor are not connected in host side.
2. An RS232 transceiver must be connected to adapt voltage level (3.3V - 12V) between STM32 device and host.

Note: +V typically 3.3 V and R value typically 100KOhm. This value depend on the application and the used hardware.

To use the DFU, connect the microcontroller's USB interface to a USB host (i.e. PC).

Figure 2. USB Connection

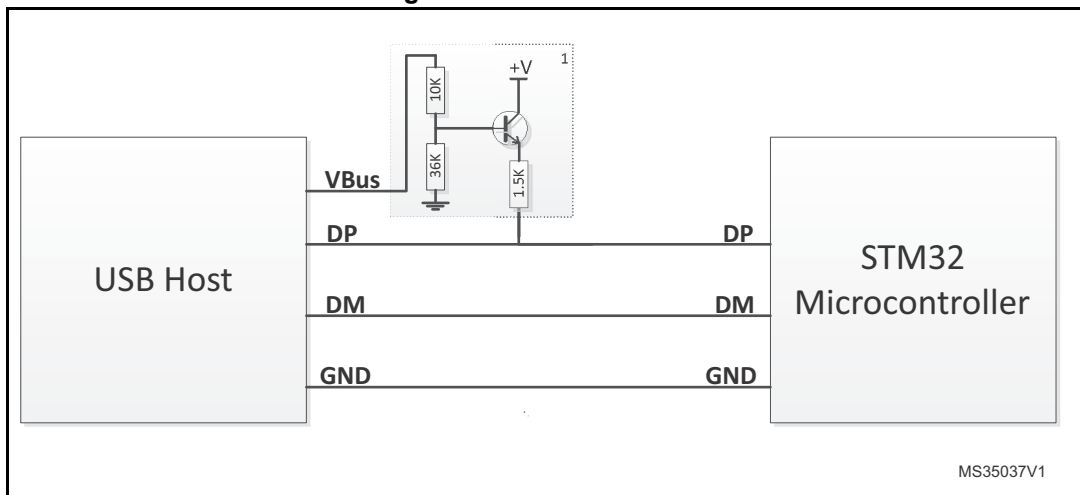

1. This additional circuit permits to connect a Pull-Up resistor to (DP) pin using VBus when needed. Refer to product section (Table which describes STM32 Configuration in system memory boot mode) to know if an external pull-up resistor must be connected to (DP) pin.

Note: +V typically 3.3 V. This value depends on the application and the used hardware.

To use the I2C bootloader, connect the host (master) and the desired I2Cx interface (slave) together via the data (SDA) and clock (SCL) pins. A 1.8 KOhm pull-up resistor has to be connected to both (SDA) and (SCL) lines.

Figure 3. I2C Connection

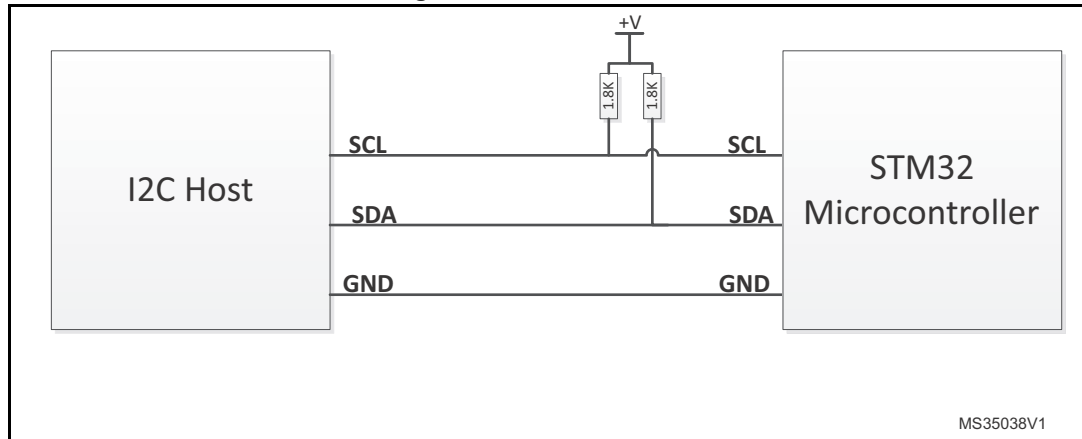

Note: +V typically 3.3 V. This value depends on the application and the used hardware.

To use the SPI bootloader, connect the host (master) and the desired SPIx interface (slave) together via the (MOSI), (MISO) and (SCK) pins. The (NSS) pin must be connected to (GND). A pull-down resistor should be connected to the (SCK) line.

Figure 4. SPI Connection

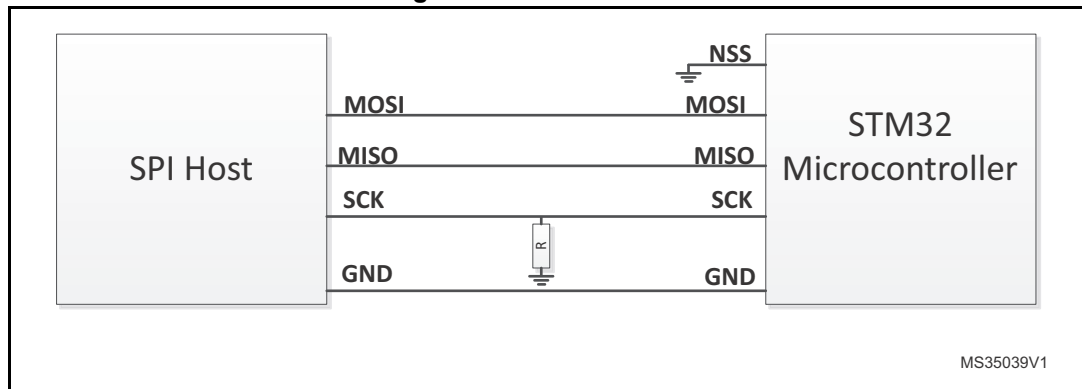

Note: R value typically 10KOhm. This value depends on the application and the used hardware.

To use the CAN interface, the host has to be connected to the (RX) and (TX) pins of the desired CANx interface via CAN transceiver and a serial cable. A 120 Ohm resistor should be added as terminating resistor.

Figure 5. CAN Connection

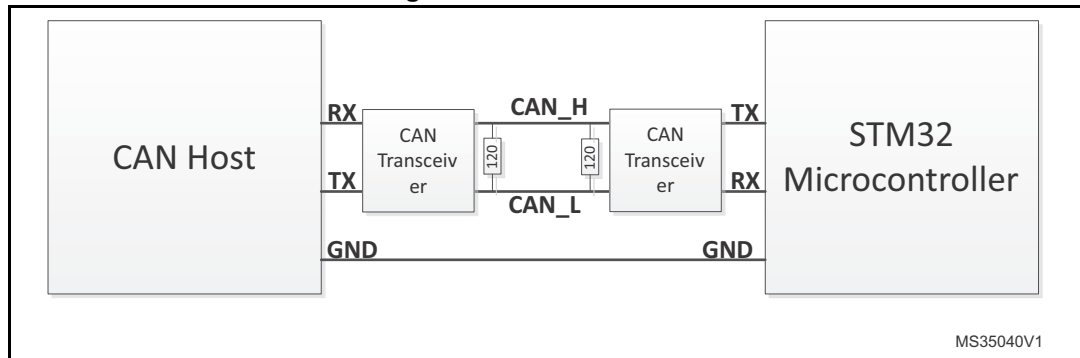

Note: When a bootloader firmware supports DFU, it is mandatory that no USB Host is connected to the USB peripheral during the selection phase of the other interfaces. After selection phase, the user can plug a USB cable without impacting the selected bootloader execution except commands which generate a system reset.

It is recommended to keep the RX pins of unused bootloader interfaces (USART_RX, SPI_MOSI, CAN_RX and USB D+/D- lines if present) at a known (low or high) level at the startup of the bootloader (detection phase). Leaving these pins floating during the detection phase might lead to activating unused interface.

4.4 Bootloader memory management

All write operations using bootloader commands must only be Word-aligned (the address should be a multiple of 4). The number of data to be written must also be a multiple of 4 (non-aligned half page write addresses are accepted).

Some Products embed bootloader that has some specific features:

- Some products don't support Mass erase operation. To perform a mass erase operation using bootloader, two options are available:
 - Erase all sectors one by one using the Erase command
 - Set protection level to Level 1. Then, set it to Level 0 (using the Read protect command and then the Read Unprotect command). This operation results in a mass erase of the internal Flash memory.
- Bootloader firmware of STM32 L1 and L0 series supports Data Memory in addition to standard memories (internal Flash, internal SRAM, option bytes and System memory). The start address and the size of this area depends on product, please refer to product reference manual for more information. Data memory can be read and written but cannot be erased using the Erase Command. When writing in a Data memory location, the bootloader firmware manages the erase operation of this location before any write. A write to Data memory must be Word-aligned (address to be written should be a multiple of 4) and the number of data must also be a multiple of 4. To erase a Data memory location, you can write zeros at this location.
- Bootloader firmware of STM32 F2, F4, F7 and L4 series supports OTP memory in addition to standard memories (internal Flash, internal SRAM, option bytes and System memory). The start address and the size of this area depends on product, please refer to product reference manual for more information. OTP memory can be read and

written but cannot be erased using Erase command. When writing in an OTP memory location, make sure that the relative protection bit is not reset.

- For STM32 F2, F4 and F7 series the internal flash write operation format depends on voltage Range. By default write operation are allowed by one byte format (Half-Word, Word and Double-Word operations are not allowed). to increase the speed of write operation, the user should apply the adequate voltage range that allows write operation by Half-Word, Word or Double-Word and update this configuration on the fly by the bootloader software through a virtual memory location. This memory location is not physical but can be read and written using usual bootloader read/write operations according to the protocol in use. This memory location contains 4 bytes which are described in table below. It can be accessed by 1, 2, 3 or 4 bytes. However, reserved bytes should remain at their default values (0xFF), otherwise the request will be NACKed.

Table 4. STM32 F2, F4 and F7 Voltage Range configuration using bootloader

Address	Size	Description
0xFFFF0000	1 byte	This byte controls the current value of the voltage range. 0x00: voltage range [1.8 V, 2.1 V] 0x01: voltage range [2.1 V, 2.4 V] 0x02: voltage range [2.4 V, 2.7 V] 0x03: voltage range [2.7 V, 3.6 V] 0x04: voltage range [2.7 V, 3.6 V] and double word write/erase operation is used. In this case it is mandatory to supply 9 V through the VPP pin (refer to the product reference manual for more details about the double-word write procedure). Other: all other values are not supported and will be NACKed.
0xFFFF0001	1 byte	Reserved. 0xFF: default value. Other: all other values are not supported and will be NACKed.
0xFFFF0002	1 byte	Reserved. 0xFF: default value. Other: all other values are not supported and will be NACKed.
0xFFFF0003	1 byte	Reserved. 0xFF: default value. Other: all other values are not supported and will be NACKed.

The table below lists the valid memory area depending on the bootloader commands.

Table 5. Supported memory area by Write, Read, Erase and Go Commands

Memory Area	Write command	Read command	Erase command	Go command
Flash	Supported	Supported	Supported	Supported
RAM	Supported	Supported	Not supported	Supported
System Memory	Not supported	Supported	Not supported	Not supported
Data Memory	Supported	Supported	Not supported	Not supported
OTP Memory	Supported	Supported	Not supported	Not supported

5 STM32F03xx4/6 devices bootloader

5.1 Bootloader configuration

The STM32F03xx4/6 bootloader is activated by applying pattern2 (described in [Table 2: Bootloader activation patterns](#)). The following table shows the hardware resources used by this bootloader.

Table 6. STM32F03xx4/6 configuration in system memory boot mode

Bootloader	Feature/Peripheral	State	Comment
Common to all bootloaders	RCC	HSI Enabled	The system clock frequency is 24 MHz (using PLL clocked by HSI). 1 Flash Wait State.
	RAM	-	2 Kbyte starting from address 0x20000000 are used by the bootloader firmware.
	System memory	-	3 Kbyte starting from address 0x1FFFE000 contain the bootloader firmware.
	IWDG	-	The independent watchdog (IWDG) prescaler is configured to its maximum value. It is periodically refreshed to prevent watchdog reset in case the hardware IWDG option was previously enabled by the user.
USART1 bootloader (on PA10/PA9)	USART1	Enabled	Once initialized, the USART1 configuration is 8 bits, even parity and 1 Stop bit.
	USART1_RX pin	Input	PA10 pin: USART1 in reception mode.
	USART1_TX pin	Output	PA9 pin: USART1 in transmission mode.
USART1 bootloader (on PA14/PA15)	USART1	Enabled	Once initialized, the USART1 configuration is 8 bits, even parity and 1 Stop bit.
	USART1_RX pin	Input	PA15 pin: USART1 in reception mode.
	USART1_TX pin	Output	PA14 pin: USART1 in transmission mode.
USART1 bootloaders	SysTick timer	Enabled	Used to automatically detect the serial baud rate from the host.

The system clock is derived from the embedded internal high-speed RC, no external quartz is required for the bootloader execution.

Note: After the STM32F03xx4/6 devices has booted in bootloader mode, serial wire debug (SWD) communication is no longer possible until the system is reset. This is because the SWD uses the PA14 pin (SWCLK) which is already used by the bootloader (USART1_TX).

5.2 Bootloader selection

The figure below shows the bootloader selection mechanism.

Figure 6. Bootloader selection for STM32F03xx4/6 devices

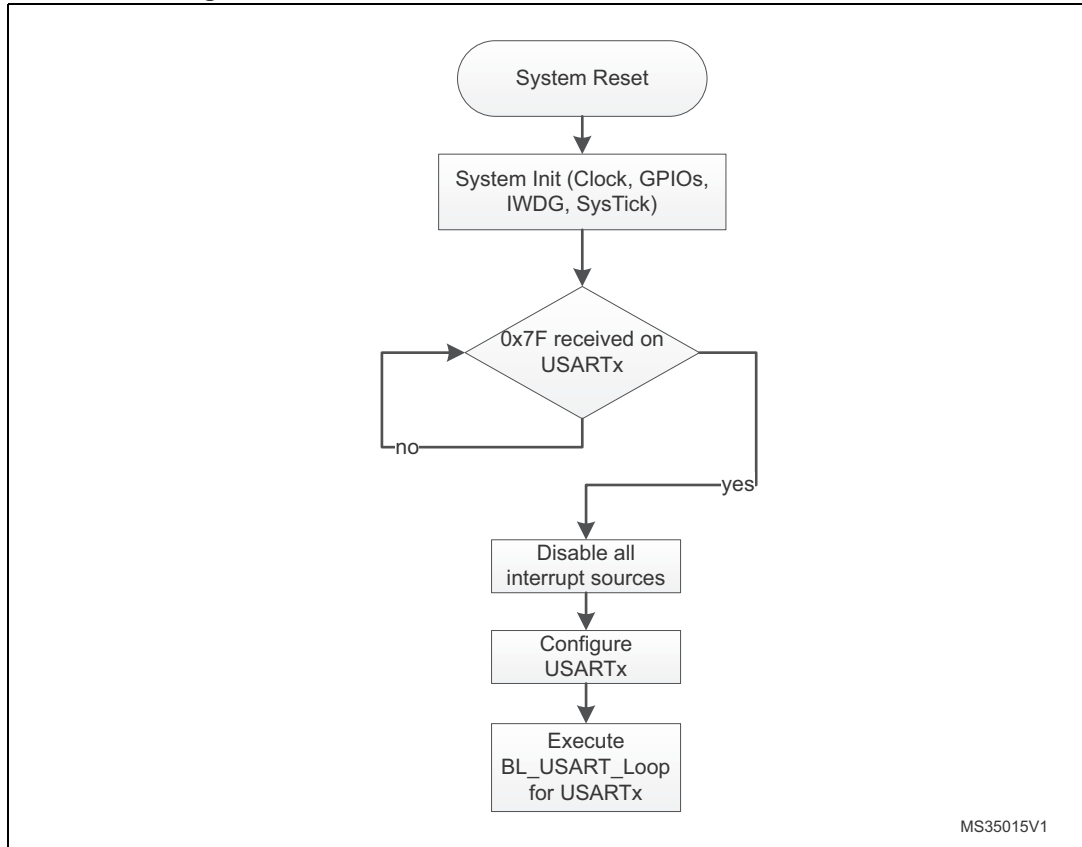

5.3 Bootloader version

The following table lists the STM32F03xx4/6 devices bootloader versions.

Table 7. STM32F03xx4/6 bootloader versions

Bootloader version number	Description	Known limitations
V1.0	Initial bootloader version	For the USART interface, two consecutive NACKs instead of 1 NACK are sent when a Read Memory or Write Memory command is sent and the RDP level is active.

6 STM32F030xC devices bootloader

6.1 Bootloader configuration

The STM32F030xC bootloader is activated by applying pattern2 (described in [Table 2: Bootloader activation patterns](#)). The following table shows the hardware resources used by this bootloader.

Table 8. STM32F030xC configuration in system memory boot mode

Bootloader	Feature/Peripheral	State	Comment
Common to all bootloaders	RCC	HSI enabled	The system clock frequency is 48 MHz with HSI 8 MHz as clock source.
	RAM	-	6 Kbyte starting from address 0x20000000 are used by the bootloader firmware
	System memory	-	8 Kbyte starting from address 0x1FFFD800, contain the bootloader firmware.
USART1 bootloader	USART1	Enabled	Once initialized the USART1 configuration is: 8-bits, even parity and 1 Stop bit
	USART1_RX pin	Input	PA10 pin: USART1 in reception mode
	USART1_TX pin	Output	PA9 pin: USART1 in transmission mode
USART2 bootloader	USART2	Enabled	Once initialized the USART2 configuration is: 8-bits, even parity and 1 Stop bit
	USART2_RX pin	Input	PA15 pin: USART2 in reception mode
	USART2_TX pin	Output	PA14 pin: USART2 in transmission mode
USARTx bootloaders	SysTick timer	Enabled	Used to automatically detect the serial baud rate from the host for USARTx bootloaders.
I2C1 bootloader	I2C1	Enabled	The I2C1 configuration is: I2C speed: up to 400 KHz, 7-bit address, slave mode, analog filter ON. Slave 7-bit address: 0b1000001x (where x = 0 for write and x = 1 for read)
	I2C1_SCL pin	Input/Output	PB6 pin: clock line is used in open-drain mode.
	I2C1_SDA pin	Input/Output	PB7 pin: data line is used in open-drain mode.

Note: After the STM32F030xC devices have booted in bootloader mode using USART2, the serial wire debug (SWD) communication is no more possible until the system is reset, because SWD uses PA14 pin (SWCLK) which is already used by the bootloader (USART2_RX).

The system clock is derived from the embedded internal high-speed RC, no external quartz is required for the bootloader execution.

6.2 Bootloader selection

The figure below shows the bootloader selection mechanism.

Figure 7.Bootloader selection for STM32F030xC

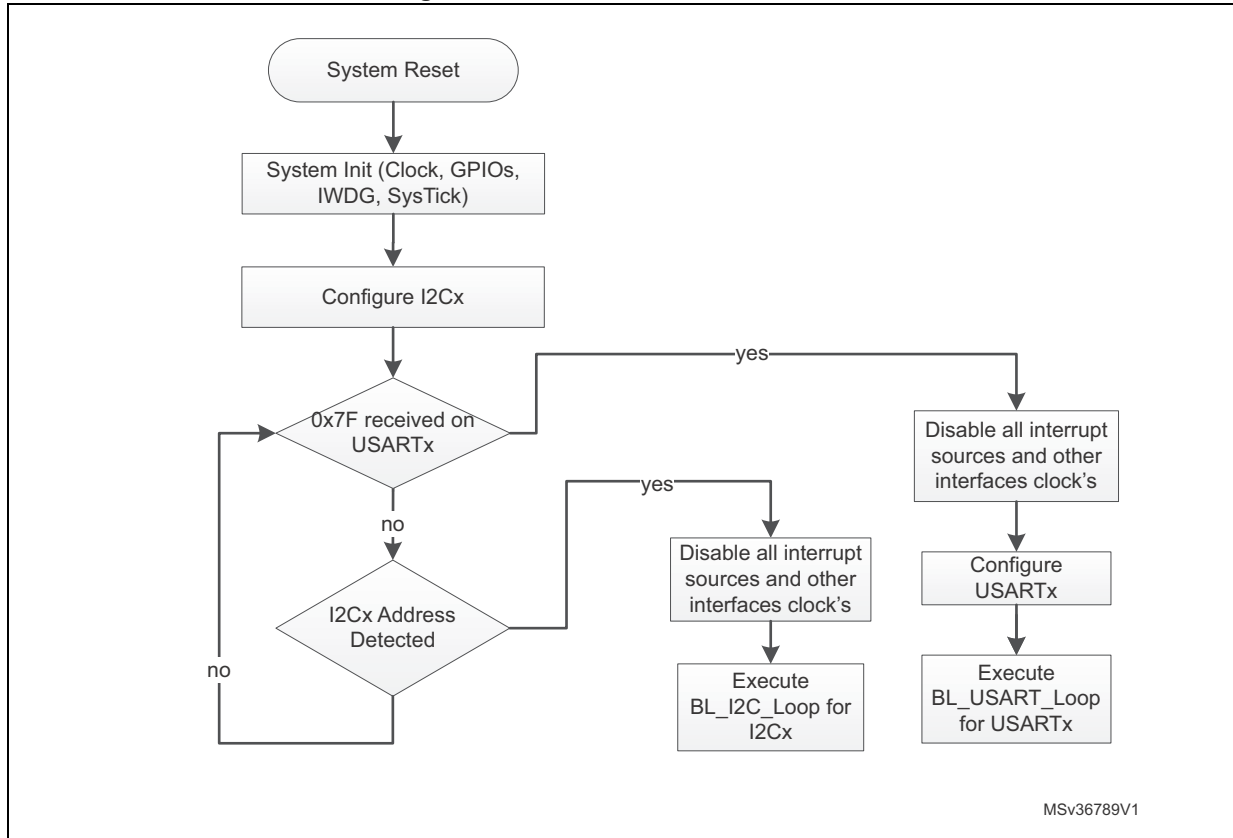

6.3 Bootloader version

The following table lists the STM32F030xC devices bootloader versions.

Table 9.STM32F030xC bootloader versions

Bootloader version number	Description	Known limitations
V5.2	Initial bootloader version	None

7 STM32F05xxx and STM32F030x8 devices bootloader

7.1 Bootloader configuration

The STM32F05xxx and STM32F030x8 devices bootloader is activated by applying pattern2 (described in [Table 2: Bootloader activation patterns](#)). The following table shows the hardware resources used by this bootloader.

Table 10. STM32F05xxx and STM32F030x8 devices configuration in system memory boot mode

Bootloader	Feature/Peripheral	State	Comment
Common to all bootloaders	RCC	HSI Enabled	The system clock frequency is 24 MHz (using PLL clocked by HSI). 1 Flash Wait State.
	RAM	-	2 Kbyte starting from address 0x20000000 are used by the bootloader firmware.
	System memory	-	3 Kbyte starting from address 0x1FFFEC00, contain the bootloader firmware.
	IWDG	-	The independent watchdog (IWDG) prescaler is configured to its maximum value. It is periodically refreshed to prevent watchdog reset in case the hardware IWDG option was previously enabled by the user.
USART1 bootloader	USART1	Enabled	Once initialized, the USART1 configuration is 8 bits, even parity and 1 Stop bit.
	USART1_RX pin	Input	PA10 pin: USART1 in reception mode.
	USART1_TX pin	Output	PA9 pin: USART1 in transmission mode.
USART2 bootloader	USART2	Enabled	Once initialized, the USART2 configuration is 8 bits, even parity and 1 Stop bit.
	USART2_RX pin	Input	PA15 pin: USART2 in reception mode.
	USART2_TX pin	Output	PA14 pin: USART2 in transmission mode.
USARTx bootloaders	SysTick timer	Enabled	Used to automatically detect the serial baud rate from the host.

The system clock is derived from the embedded internal high-speed RC, no external quartz is required for the bootloader execution.

Note: After the STM32F05xxx and STM32F030x8 devices have booted in bootloader mode, the serial wire debug (SWD) communication is no more possible until the system is reset, because SWD uses PA14 pin (SWCLK) which is already used by the bootloader (USART2_TX).

7.2 Bootloader selection

The figure below shows the bootloader selection mechanism.

Figure 8. Bootloader selection for STM32F05xxx and STM32F030x8 devices

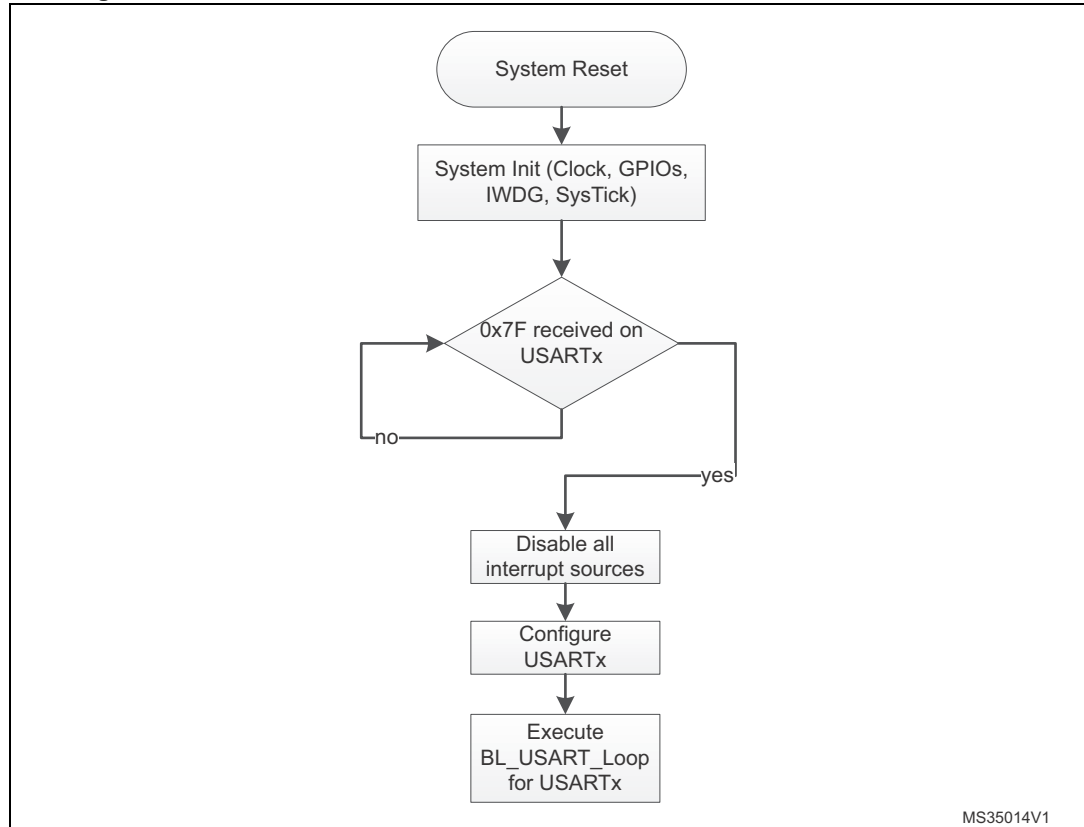

7.3 Bootloader version

The following table lists the STM32F05xxx and STM32F030x8 devices bootloader versions.

Table 11. STM32F05xxx and STM32F030x8 devices bootloader versions

Bootloader version number	Description	Known limitations
V2.1	Initial bootloader version	<ul style="list-style-type: none"> – At bootloader startup, the HSITRIM value is set to (0) (in HSITRIM bits on RCC_CR register) instead of default value (16), as consequence a deviation is generated in crystal measurement. For better results, please use the smallest supported crystal value (ie. 4 MHz). – For the USART interface, two consecutive NACKs instead of 1 NACK are sent when a Read Memory or Write Memory command is sent and the RDP level is active.

8 STM32F04xxx devices bootloader

8.1 Bootloader configuration

The STM32F04xxx bootloader is activated by applying pattern6 (described in [Table 2: Bootloader activation patterns](#)). The following table shows the hardware resources used by this bootloader.

Table 12. STM32F04xxx configuration in system memory boot mode

Bootloader	Feature/Peripheral	State	Comment
Common to all bootloaders	RCC	HSI enabled	The system clock frequency is 48 MHz with HSI48 48 MHz as clock source.
		-	The clock recovery system (CRS) is enabled for the DFU bootloader to allow USB to be clocked by HSI48 48 MHz.
	RAM	-	6 Kbyte starting from address 0x20000000 are used by the bootloader firmware
	System memory	-	13 Kbyte starting from address 0x1FFFC400, contain the bootloader firmware
	IWDG	-	The independent watchdog (IWDG) prescaler is configured to its maximum value. It is periodically refreshed to prevent watchdog reset (in case the hardware IWDG option was previously enabled by the user).
USART1 bootloader	USART1	Enabled	Once initialized the USART1 configuration is: 8-bits, even parity and 1 Stop bit
	USART1_RX pin	Input	PA10 pin: USART1 in reception mode
	USART1_TX pin	Output	PA9 pin: USART1 in transmission mode
USART2 bootloader	USART2	Enabled	Once initialized the USART2 configuration is: 8-bits, even parity and 1 Stop bit
	USART2_RX pin	Input	PA15 pin: USART2 in reception mode
	USART2_TX pin	Output	PA14 pin: USART2 in transmission mode
USARTx bootloaders	SysTick timer	Enabled	Used to automatically detect the serial baud rate from the host for USARTx bootloaders.
I2C1 bootloader	I2C1	Enabled	The I2C1 configuration is: I2C speed: up to 400 KHz, 7-bit address, slave mode, analog filter ON. Slave 7-bit address: 0b0111110x (where x = 0 for write and x = 1 for read).
	I2C1_SCL pin	Input/Output	PB6 pin: clock line is used in open-drain mode.
	I2C1_SDA pin	Input/Output	PB7 pin: data line is used in open-drain mode.

Table 12. STM32F04xxx configuration in system memory boot mode (continued)

Bootloader	Feature/Peripheral	State	Comment
DFU bootloader	USB	Enabled	USB used in FS mode
	USB_DM pin	Input/Output	PA11: USB DM line.
	USB_DP pin		PA12: USB DP line No external pull-up resistor is required.

Note: After the STM32F04xxx devices have booted in bootloader mode using USART2, the serial wire debug (SWD) communication is no more possible until the system is reset, because SWD uses PA14 pin (SWCLK) which is already used by the bootloader (USART2_RX).

The system clock is derived from the embedded internal high-speed RC, no external quartz is required for the bootloader execution.

Note: Due to empty check mechanism present on this product, it is not possible to jump from user code to system bootloader.

Such jump will result in a jump back to user flash space.

But if the first 4 bytes of User Flash (at 0x0800 0000) are empty at the moment of jump (ie. erase first sector before jump or execute code from SRAM while Flash is empty), then system bootloader will be executed when jumped to.

8.2 Bootloader selection

The figure below shows the bootloader selection mechanism.

Figure 9. Bootloader selection for STM32F04xxx

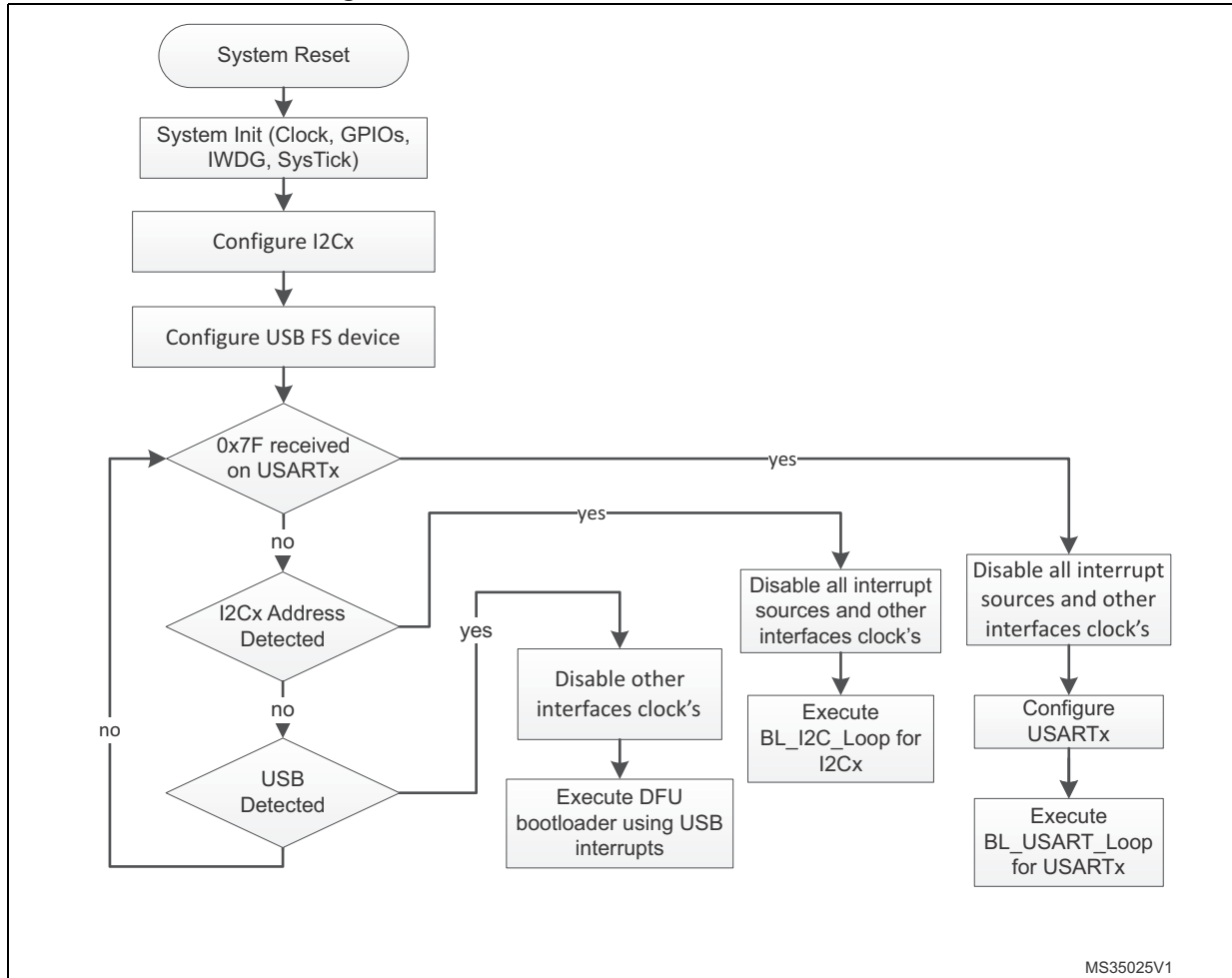

8.3 Bootloader version

The following table lists the STM32F04xxx devices bootloader versions:

Table 13. STM32F04xxx bootloader versions

Bootloader version number	Description	Known limitations
V10.0	Initial bootloader version	At bootloader startup, the HSITRIM value is set to (0) (in HSITRIM bits on RCC_CR register) instead of default value (16), as consequence a deviation is generated in crystal measurement. For better results, please use the smallest supported crystal value (ie. 4 MHz).
V10.1	Add dynamic support of USART/USB interfaces on PA11/12 IOs for small packages.	

9 STM32F070x6 devices bootloader

9.1 Bootloader configuration

The STM32F070x6 bootloader is activated by applying pattern6 (described in [Table 2: Bootloader activation patterns](#)). The following table shows the hardware resources used by this bootloader.

Table 14. STM32F070x6 configuration in system memory boot mode

Bootloader	Feature/Peripheral	State	Comment
Common to all bootloaders	RCC	HSI enabled	At startup, the system clock frequency is configured to 48 MHz using the HSI. If an external clock (HSE) is not present, the system is kept clocked from the HSI.
		HSE enabled	The external clock can be used for all bootloader interfaces and should have one of the following values [24, 18, 16, 12, 8, 6, 4] MHz. The PLL is used to generate 48 MHz for USB and system clock.
		-	The Clock Security System (CSS) interrupt is enabled for HSE. Any failure (or removal) of the external clock generates system reset.
	RAM	-	6 Kbyte starting from address 0x20000000 are used by the bootloader firmware
	System memory	-	13 Kbyte starting from address 0x1FFFC400, contain the bootloader firmware.
USART1 bootloader	USART1	Enabled	Once initialized the USART1 configuration is: 8-bits, even parity and 1 Stop bit
	USART1_RX pin	Input	PA10 pin: USART1 in reception mode
	USART1_TX pin	Output	PA9 pin: USART1 in transmission mode
USART2 bootloader	USART2	Enabled	Once initialized the USART2 configuration is: 8-bits, even parity and 1 Stop bit
	USART2_RX pin	Input	PA15 pin: USART2 in reception mode
	USART2_TX pin	Output	PA14 pin: USART2 in transmission mode
USARTx bootloaders	SysTick timer	Enabled	Used to automatically detect the serial baud rate from the host for USARTx bootloaders.
I2C1 bootloader	I2C1	Enabled	The I2C1 configuration is: I2C speed: up to 400 KHz, 7-bit address, slave mode, analog filter ON. Slave 7-bit address: 0b0111110x where x = 0 for write and x = 1 for read)
	I2C1_SCL pin	Input/Output	PB6 pin: clock line is used in open-drain mode.
	I2C1_SDA pin	Input/Output	PB7 pin: data line is used in open-drain mode.

Table 14. STM32F070x6 configuration in system memory boot mode (continued)

Bootloader	Feature/Peripheral	State	Comment
DFU bootloader	USB	Enabled	USB FS configured in forced device mode. USB FS interrupt vector is enabled and used for USB DFU communications.
	USB_DM pin	Input/Output	PA11 pin: USB FS DM line
	USB_DP pin		PA12 pin: USB FS DP line. No external Pull-up resistor is required.

Note: If HSI deviation exceeds 1% , the bootloader might not function correctly.

Note: After the STM32F070x6 devices have booted in bootloader mode using USART2, the serial wire debug (SWD) communication is no more possible until the system is reset, because SWD uses PA14 pin (SWCLK) which is already used by the bootloader (USART2_RX).

The bootloader has two cases of operation depending on the presence of the external clock (HSE) at bootloader startup:

- If HSE is present and has a value of 24, 18, 16, 12, 8, 6, 4 MHz, the system clock is configured to 48 MHz with HSE as clock source. The DFU interface, USART1, USART2 and I2C1 are functional and can be used to communicate with the bootloader device.
- If HSE is not present, the HSI is kept as default clock source and only USART1, USART2 and I2C1 are functional.

The external clock (HSE) must be kept if it's connected at bootloader startup because it will be used as system clock source.

Note: Due to empty check mechanism present on this product, it is not possible to jump from user code to system bootloader.

Such jump will result in a jump back to user flash space.

But if the first 4 bytes of User Flash (at 0x0800 0000) are empty at the moment of jump (ie. erase first sector before jump or execute code from SRAM while Flash is empty), then system bootloader will be executed when jumped to.

9.2 Bootloader selection

The figure below shows the bootloader selection mechanism.

Figure 10.Bootloader selection for STM32F070x6

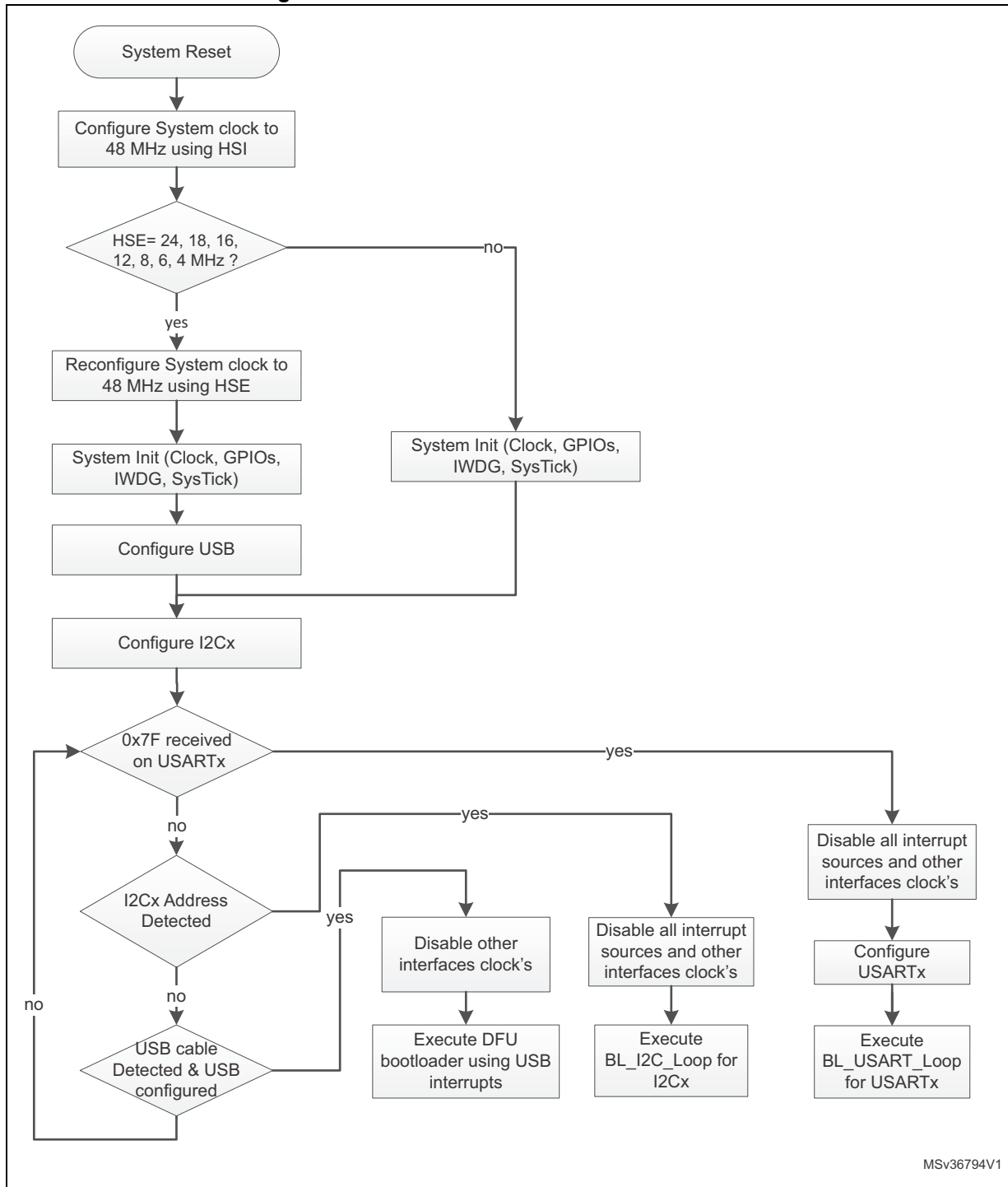

MSv36794V1

9.3 Bootloader version

The following table lists the STM32F070x6 devices bootloader versions.

Table 15. STM32F070x6 bootloader versions

Bootloader version number	Description	Known limitations
V10.2	Initial bootloader version	At bootloader startup, the HSITRIM value is set to (0) (in HSITRIM bits on RCC_CR register) instead of default value (16), as consequence a deviation is generated in crystal measurement. For better results, please use the smallest supported crystal value (ie. 4 MHz).
V10.3	Clock configuration fixed to HSI 8 MHz	

10 STM32F070xB devices bootloader

10.1 Bootloader configuration

The STM32F070xB bootloader is activated by applying pattern2 (described in [Table 2: Bootloader activation patterns](#)). The following table shows the hardware resources used by this bootloader.

Table 16. STM32F070xB configuration in system memory boot mode

Bootloader	Feature/Peripheral	State	Comment
Common to all bootloaders	RCC	HSI enabled	At startup, the system clock frequency is configured to 48 MHz using the HSI. If an external clock (HSE) is not present, the system is kept clocked from the HSI.
		HSE enabled	The external clock can be used for all bootloader interfaces and should have one of the following values [24, 18, 16, 12, 8, 6, 4] MHz. The PLL is used to generate 48 MHz for USB and system clock.
		-	The Clock Security System (CSS) interrupt is enabled for HSE. Any failure (or removal) of the external clock generates system reset.
	RAM	-	6 Kbyte starting from address 0x20000000 are used by the bootloader firmware
	System memory	-	12 Kbyte starting from address 0x1FFFC800, contain the bootloader firmware.
USART1 bootloader	USART1	Enabled	Once initialized the USART1 configuration is: 8-bits, even parity and 1 Stop bit
	USART1_RX pin	Input	PA10 pin: USART1 in reception mode
	USART1_TX pin	Output	PA9 pin: USART1 in transmission mode
USART2 bootloader	USART2	Enabled	Once initialized the USART2 configuration is: 8-bits, even parity and 1 Stop bit
	USART2_RX pin	Input	PA15 pin: USART2 in reception mode
	USART2_TX pin	Output	PA14 pin: USART2 in transmission mode
USARTx bootloaders	SysTick timer	Enabled	Used to automatically detect the serial baud rate from the host for USARTx bootloaders.
I2C1 bootloader	I2C1	Enabled	The I2C1 configuration is: I2C speed: up to 400 KHz, 7-bit address, slave mode, analog filter ON. Slave 7-bit address: 0b0111011x (where x = 0 for write and x = 1 for read)
	I2C1_SCL pin	Input/Output	PB6 pin: clock line is used in open-drain mode.
	I2C1_SDA pin	Input/Output	PB7 pin: data line is used in open-drain mode.

Table 16. STM32F070xB configuration in system memory boot mode (continued)

Bootloader	Feature/Peripheral	State	Comment
DFU bootloader	USB	Enabled	USB FS configured in forced device mode. USB FS interrupt vector is enabled and used for USB DFU communications.
	USB_DM pin	Input/Output	PA11 pin: USB FS DM line
	USB_DP pin		PA12 pin: USB FS DP line. No external Pull-up resistor is required.

Note: If HSI deviation exceeds 1% , the bootloader might not function correctly.

Note: After the STM32F070xB devices have booted in bootloader mode using USART2, the serial wire debug (SWD) communication is no more possible until the system is reset, because SWD uses PA14 pin (SWCLK) which is already used by the bootloader (USART2_RX).

The bootloader has two cases of operation depending on the presence of the external clock (HSE) at bootloader startup:

- If HSE is present and has a value of 24, 18, 16, 12, 8, 6, 4 MHz, the system clock is configured to 48 MHz with HSE as clock source. The DFU interface, USART1, USART2 and I2C1 are functional and can be used to communicate with the bootloader device.
- If HSE is not present, the HSI is kept as default clock source and only USART1, USART2 and I2C1 are functional.

The external clock (HSE) must be kept if it's connected at bootloader startup because it will be used as system clock source.

10.2 Bootloader selection

The figure below shows the bootloader selection mechanism.

Figure 11.Bootloader selection for STM32F070xB

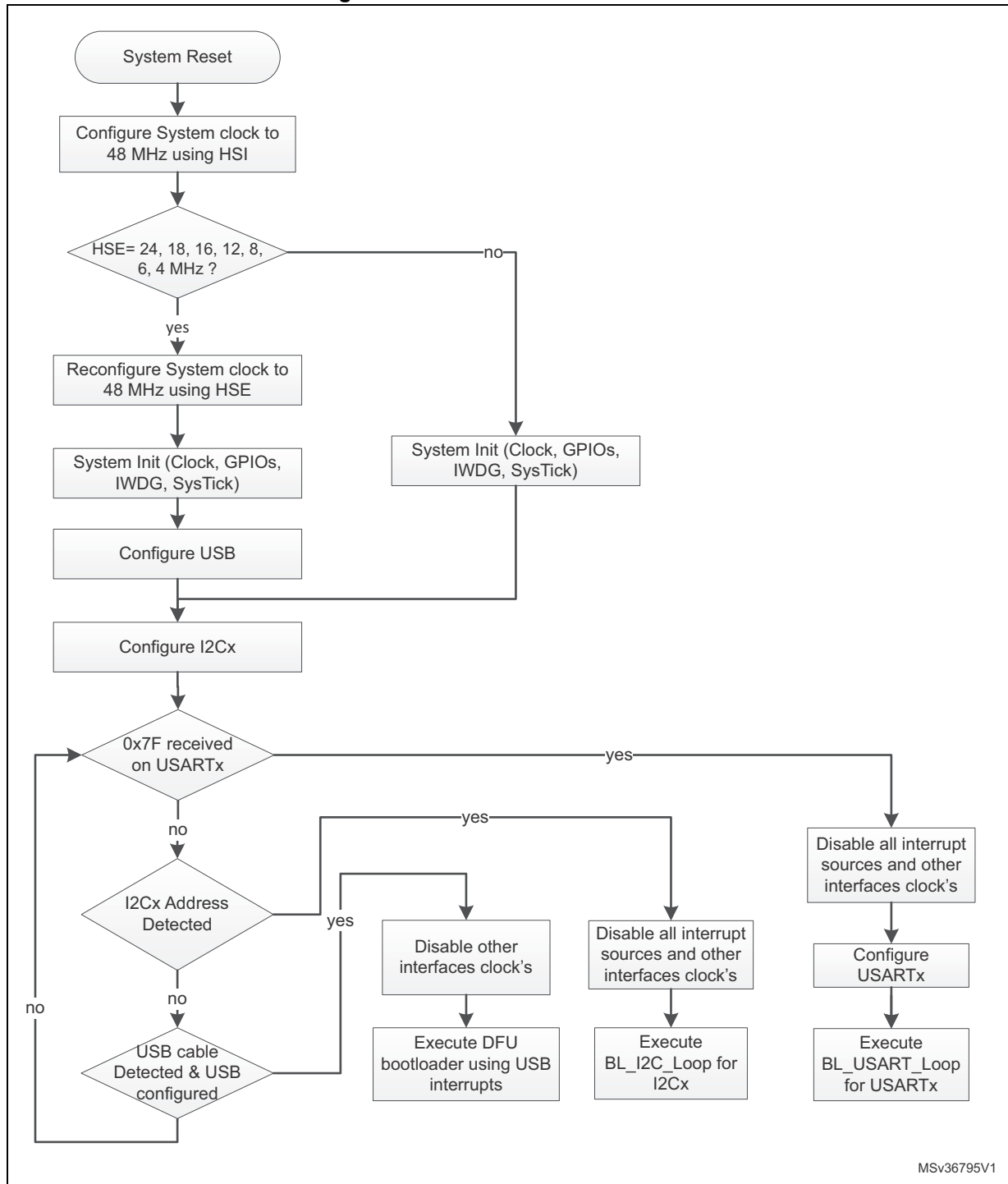

10.3 Bootloader version

The following table lists the STM32F070xB devices bootloader versions.

Table 17. STM32F070xB bootloader versions

Bootloader version number	Description	Known limitations
V10.2	Initial bootloader version	At bootloader startup, the HSITRIM value is set to (0) (in HSITRIM bits on RCC_CR register) instead of default value (16), as consequence a deviation is generated in crystal measurement. For better results, please use the smallest supported crystal value (ie. 4 MHz).
V10.3	Clock configuration fixed to HSI 8 MHz	

11 STM32F071xx/072xx devices bootloader

11.1 Bootloader configuration

The STM32F071xx/072xx bootloader is activated by applying pattern2 (described in [Table 2: Bootloader activation patterns](#)). The following table shows the hardware resources used by this bootloader.

Table 18. STM32F071xx/072xx configuration in system memory boot mode

Bootloader	Feature/Peripheral	State	Comment
Common to all bootloaders	RCC	HSI enabled	The system clock frequency is 48 MHz with HSI48 48 MHz as clock source.
		-	The clock recovery system (CRS) is enabled for the DFU bootloader to allow USB to be clocked by HSI48 48 MHz.
	RAM	-	6 Kbyte starting from address 0x20000000 are used by the bootloader firmware
	System memory	-	12 Kbyte starting from address 0x1FFFC800, contain the bootloader firmware
	IWDG	-	The independent watchdog (IWDG) prescaler is configured to its maximum value. It is periodically refreshed to prevent watchdog reset (in case the hardware IWDG option was previously enabled by the user).
USART1 bootloader	USART1	Enabled	Once initialized the USART1 configuration is: 8-bits, even parity and 1 Stop bit
	USART1_RX pin	Input	PA10 pin: USART1 in reception mode
	USART1_TX pin	Output	PA9 pin: USART1 in transmission mode
USART2 bootloader	USART2	Enabled	Once initialized the USART2 configuration is: 8-bits, even parity and 1 Stop bit
	USART2_RX pin	Input	PA15 pin: USART2 in reception mode
	USART2_TX pin	Output	PA14 pin: USART2 in transmission mode
USARTx bootloaders	SysTick timer	Enabled	Used to automatically detect the serial baud rate from the host for USARTx bootloaders.
I2C1 bootloader	I2C1	Enabled	The I2C1 configuration is: I2C speed: up to 400 KHz, 7-bit address, slave mode, analog filter ON. Slave 7-bit address: 0b0111011x (where x = 0 for write and x = 1 for read)
	I2C1_SCL pin	Input/Output	PB6 pin: clock line is used in open-drain mode.
	I2C1_SDA pin	Input/Output	PB7 pin: data line is used in open-drain mode.

Table 18. STM32F071xx/072xx configuration in system memory boot mode (continued)

Bootloader	Feature/Peripheral	State	Comment
DFU bootloader	USB	Enabled	USB used in FS mode
	USB_DM pin	Input/Output	PA11: USB DM line.
	USB_DP pin		PA12: USB DP line No external pull-up resistor is required.

Note: After the STM32F071xx/072xx devices have booted in bootloader mode using USART2, the serial wire debug (SWD) communication is no more possible until the system is reset, because SWD uses PA14 pin (SWCLK) which is already used by the bootloader (USART2_RX).

The system clock is derived from the embedded internal high-speed RC, no external quartz is required for the bootloader execution.

11.2 Bootloader selection

The figure below shows the bootloader selection mechanism.

Figure 12. Bootloader selection for STM32F071xx/072xx

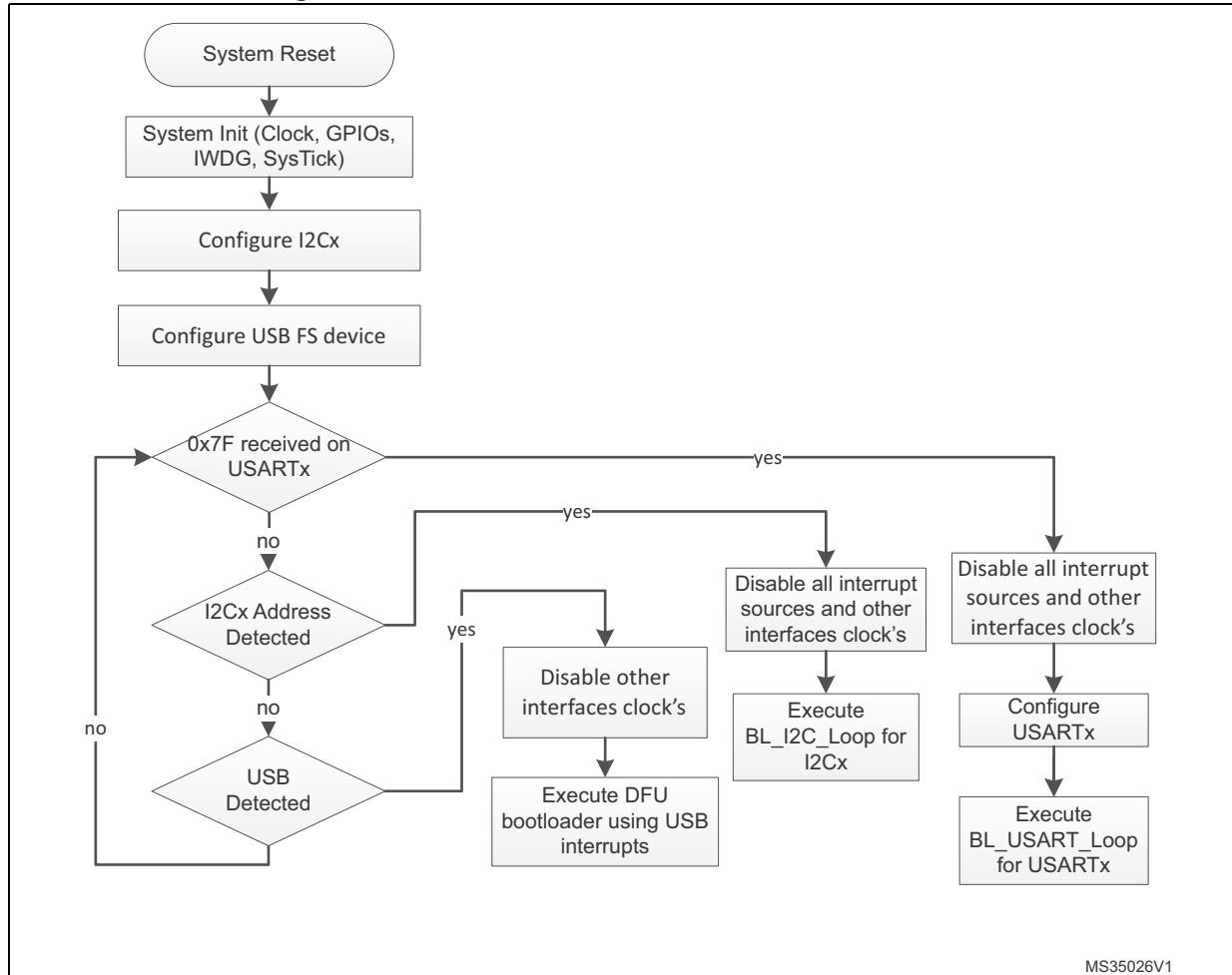

11.3 Bootloader version

The following table lists the STM32F071xx/072xx devices bootloader versions:

Table 19. STM32F071xx/072xx bootloader versions

Bootloader version number	Description	Known limitations
V10.1	Initial bootloader version	At bootloader startup, the HSITRIM value is set to (0) (in HSITRIM bits on RCC_CR register) instead of default value (16), as consequence a deviation is generated in crystal measurement. For better results, please use the smallest supported crystal value (ie. 4 MHz).

12 STM32F09xxx devices bootloader

12.1 Bootloader configuration

The STM32F09xxx bootloader is activated by applying pattern6 (described in [Table 2: Bootloader activation patterns](#)). The following table shows the hardware resources used by this bootloader.

Table 20. STM32F09xxx configuration in system memory boot mode

Bootloader	Feature/Peripheral	State	Comment
Common to all bootloaders	RCC	HSI enabled	The system clock frequency is 48 MHz with HSI48 48 MHz as clock source.
	RAM	-	6 Kbyte starting from address 0x20000000 are used by the bootloader firmware
	System memory	-	8 Kbyte starting from address 0x1FFFD800, contain the bootloader firmware.
USART1 bootloader	USART1	Enabled	Once initialized the USART1 configuration is: 8-bits, even parity and 1 Stop bit
	USART1_RX pin	Input	PA10 pin: USART1 in reception mode
	USART1_TX pin	Output	PA9 pin: USART1 in transmission mode
USART2 bootloader	USART2	Enabled	Once initialized the USART2 configuration is: 8-bits, even parity and 1 Stop bit
	USART2_RX pin	Input	PA3 pin: USART2 in reception mode
			PA15 pin: USART2 in reception mode
	USART2_TX pin	Output	PA2 pin: USART2 in transmission mode
PA14 pin: USART2 in transmission mode			
USARTx bootloaders	SysTick timer	Enabled	Used to automatically detect the serial baud rate from the host for USARTx bootloaders.
I2C1 bootloader	I2C1	Enabled	The I2C1 configuration is: I2C speed: up to 400 KHz, 7-bit address, slave mode, analog filter ON. Slave 7-bit address: 0b1000001x (where x = 0 for write and x = 1 for read)
	I2C1_SCL pin	Input/Output	PB6 pin: clock line is used in open-drain mode.
	I2C1_SDA pin	Input/Output	PB7 pin: data line is used in open-drain mode.

Note: After the STM32F09xxx devices have booted in bootloader mode using USART2, the serial wire debug (SWD) communication is no more possible until the system is reset, because SWD uses PA14 pin (SWCLK) which is already used by the bootloader (USART2_RX).

The system clock is derived from the embedded internal high-speed RC, no external quartz is required for the bootloader execution.

12.2 Bootloader selection

The figure below shows the bootloader selection mechanism.

Figure 13. Bootloader selection for STM32F09xxx

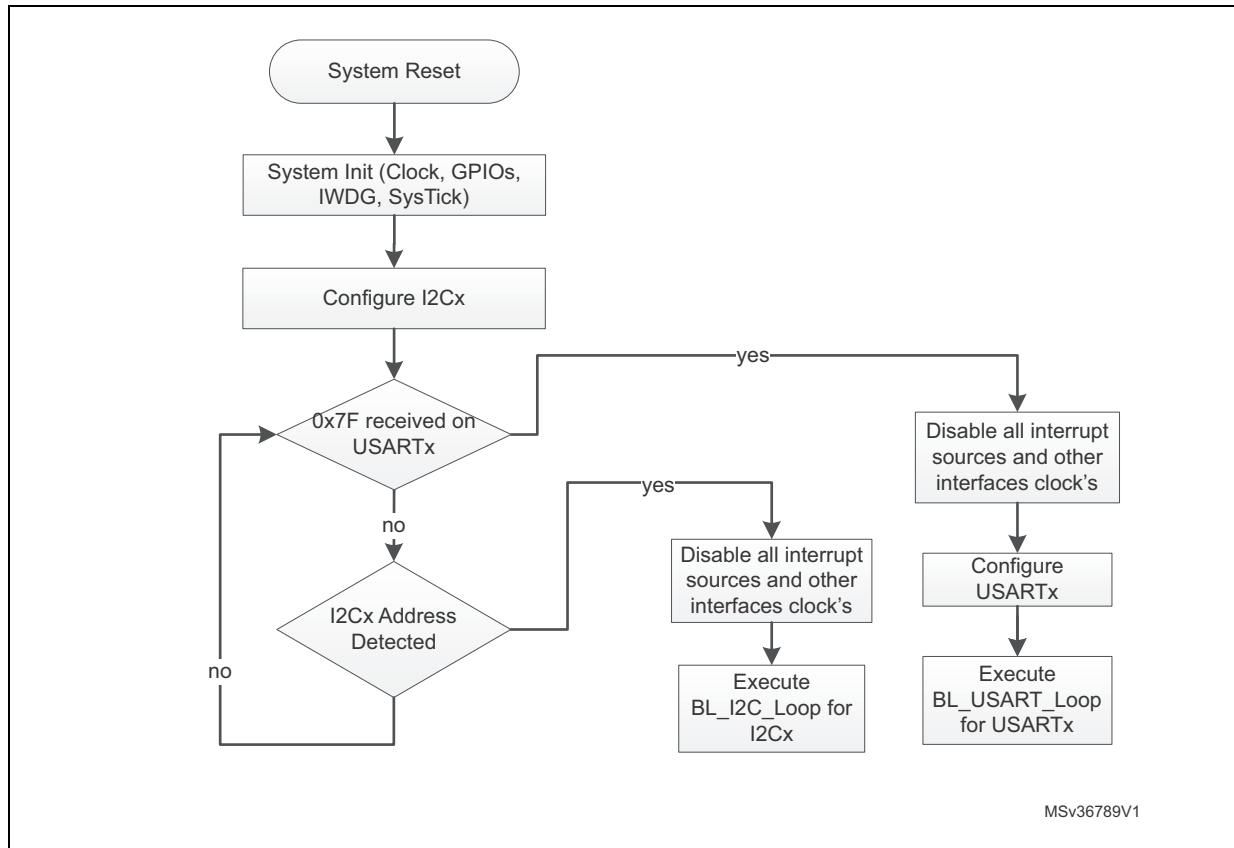

12.3 Bootloader version

The following table lists the STM32F09xxx devices bootloader versions.

Table 21. STM32F09xxx bootloader versions

Bootloader version number	Description	Known limitations
V5.0	Initial bootloader version	At bootloader startup, the HSITRIM value is set to (0) (in HSITRIM bits on RCC_CR register) instead of default value (16), as consequence a deviation is generated in crystal measurement. For better results, please use the smallest supported crystal value (ie. 4 MHz).

13 STM32F10xxx devices bootloader

13.1 Bootloader configuration

The STM32F10xxx bootloader is activated by applying pattern1 (described in [Table 2: Bootloader activation patterns](#)). The following table shows the hardware resources used by this bootloader.

Table 22. STM32F10xxx configuration in system memory boot mode

Bootloader	Feature/Peripheral	State	Comment
USART1 bootloader	RCC	HSI enabled	The system clock frequency is 24 MHz using the PLL.
	RAM	-	512 byte starting from address 0x20000000 are used by the bootloader firmware.
	System memory	-	2 Kbyte starting from address 0x1FFFF000 contain the bootloader firmware.
	IWDG	-	The independent watchdog (IWDG) prescaler is configured to its maximum value and is periodically refreshed to prevent watchdog reset (in case the hardware IWDG option was previously enabled by the user).
	USART1	Enabled	Once initialized, the USART1 configuration is: 8 bits, even parity and 1 Stop bit.
	USART1_RX pin	Input	PA10 pin: USART1 in reception mode
	USART1_TX pin	Output push-pull	PA9 pin: USART1 in transmission mode
	SysTick timer	Enabled	Used to automatically detect the serial baud rate from the host.

The system clock is derived from the embedded internal high-speed RC, no external quartz is required for the bootloader execution.

13.2 Bootloader selection

The figure below shows the bootloader selection mechanism.

Figure 14. Bootloader selection for STM32F10xxx

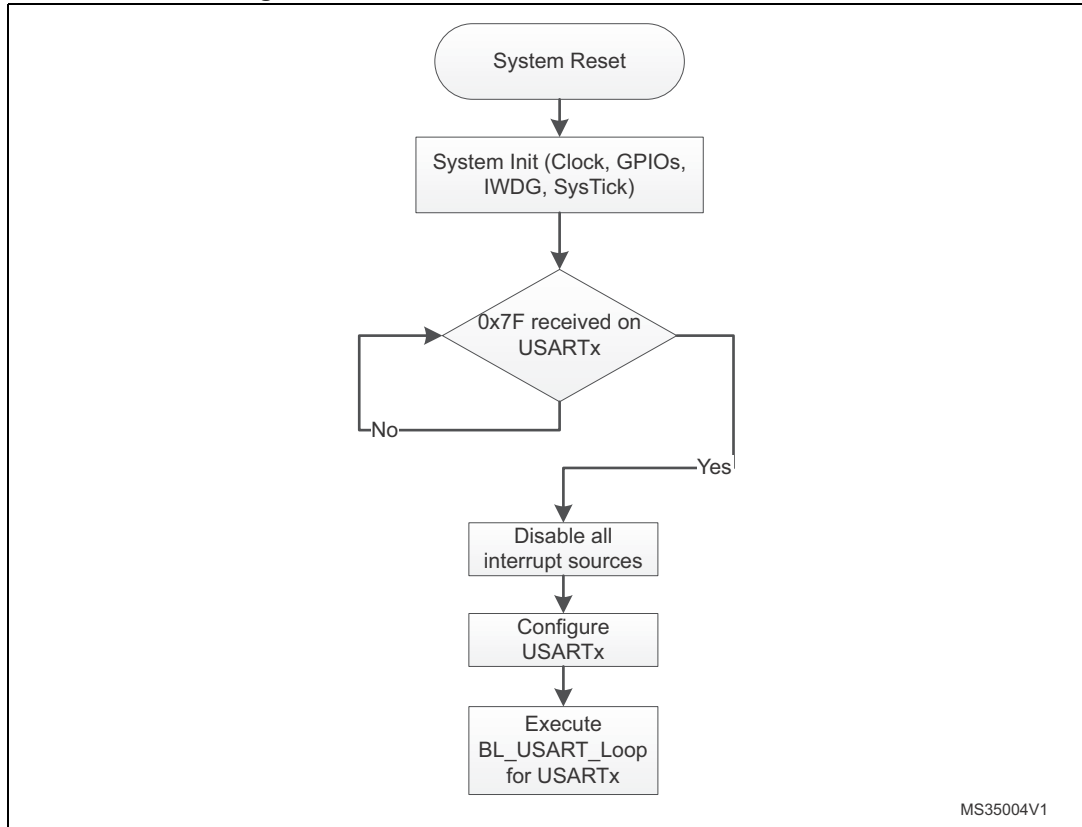

13.3 Bootloader version

The following table lists the STM32F10xxx devices bootloader versions:

Table 23. STM32F10xxx bootloader versions

Bootloader version number	Description
V2.0	Initial bootloader version
V2.1	<ul style="list-style-type: none"> – Updated Go Command to initialize the main stack pointer – Updated Go command to return NACK when jump address is in the Option byte area or System memory area – Updated Get ID command to return the device ID on two bytes – Update the bootloader version to V2.1
V2.2	<ul style="list-style-type: none"> – Updated Read Memory, Write Memory and Go commands to deny access with a NACK response to the first 0x200 bytes of RAM memory used by the bootloader – Updated Readout Unprotect command to initialize the whole RAM content to 0x0 before ROP disable operation

Note: The bootloader ID format is applied to all STM32 devices families except the STM32F1xx family. The bootloader version for the STM32F1xx applies only to the embedded device's bootloader version and not to its supported protocols.

14 STM32F105xx/107xx devices bootloader

14.1 Bootloader configuration

The STM32F105xx/107xx bootloader is activated by applying pattern1 (described in [Table 2: Bootloader activation patterns](#)). The following table shows the hardware resources used by this bootloader.

Table 24. STM32F105xx/107xx configuration in system memory boot mode

Bootloader	Feature/Peripheral	State	Comment
Common to all bootloaders	RCC	HSI enabled	The system clock frequency is 24 MHz using the PLL. This is used only for USARTx bootloaders and during CAN2, USB detection for CAN and DFU bootloaders (once CAN or DFU bootloader is selected, the clock source will be derived from the external crystal).
		HSE enabled	The external clock is mandatory only for DFU and CAN bootloaders and it must provide one of the following frequencies: 8 MHz, 14.7456 MHz or 25 MHz. For CAN bootloader, the PLL is used only to generate 48 MHz when 14.7456 MHz is used as HSE. For DFU bootloader, the PLL is used to generate a 48 MHz system clock from all supported external clock frequencies.
		-	The Clock Security System (CSS) interrupt is enabled for the CAN and DFU bootloaders. Any failure (or removal) of the external clock will generate system reset.
	RAM	-	4 Kbyte starting from address 0x20000000 are used by the bootloader firmware.
	System memory	-	18 Kbyte starting from address 0x1FFFB000 contain the bootloader firmware.
	IWDG	-	The independent watchdog (IWDG) prescaler is configured to its maximum value and is periodically refreshed to prevent watchdog reset (in case the hardware IWDG option was previously enabled by the user).
USART1 bootloader	USART1	Enabled	Once initialized, the USART1 configuration is: 8 bits, even parity and 1 Stop bit.
	USART1_RX pin	Input	PA10 pin: USART1 in reception mode
	USART1_TX pin	Output push-pull	PA9 pin: USART1 in transmission mode

Table 24. STM32F105xx/107xx configuration in system memory boot mode (continued)

Bootloader	Feature/Peripheral	State	Comment
USART2 bootloader	USART2	Enabled	Once initialized, the USART2 configuration is: 8 bits, even parity and 1 Stop bit. The USART2 uses its remapped pins.
	USART2_RX pin	Input	PD6 pin: USART2 receive (remapped pin)
	USART2_TX pin	Output push-pull	PD5 pin: USART2 transmit (remapped pin)
USARTx bootloaders	SysTick timer	Enabled	Used to automatically detect the serial baud rate from the host for USARTx bootloader.
CAN2 bootloader	CAN2	Enabled	Once initialized, the CAN2 configuration is: Baudrate 125 kbps, 11-bit identifier. Note: CAN1 is clocked during the CAN bootloader execution because CAN1 manages the communication between CAN2 and SRAM.
	CAN2_RX pin	Input	PB5 pin: CAN2 receives (remapped pin).
	CAN2_TX pin	Output push-pull	PB6 pin: CAN2 transmits (remapped pin).
DFU bootloader	USB	Enabled	USB OTG FS configured in forced device mode
	USB_VBUS pin	Input	PA9: Power supply voltage line
	USB_DM pin	Input/Output	PA11 pin: USB_DM line
	USB_DP pin		PA12 pin: USB_DP line. No external Pull-up resistor is required

The system clock is derived from the embedded internal high-speed RC for USARTx bootloader. This internal clock is used also for DFU and CAN bootloaders but only for the selection phase. An external clock (8 MHz, 14.7456 MHz or 25 MHz.) is required for DFU and CAN bootloader execution after the selection phase.

14.2 Bootloader selection

The figure below shows the bootloader selection mechanism.

Figure 15. Bootloader selection for STM32F105xx/107xx devices

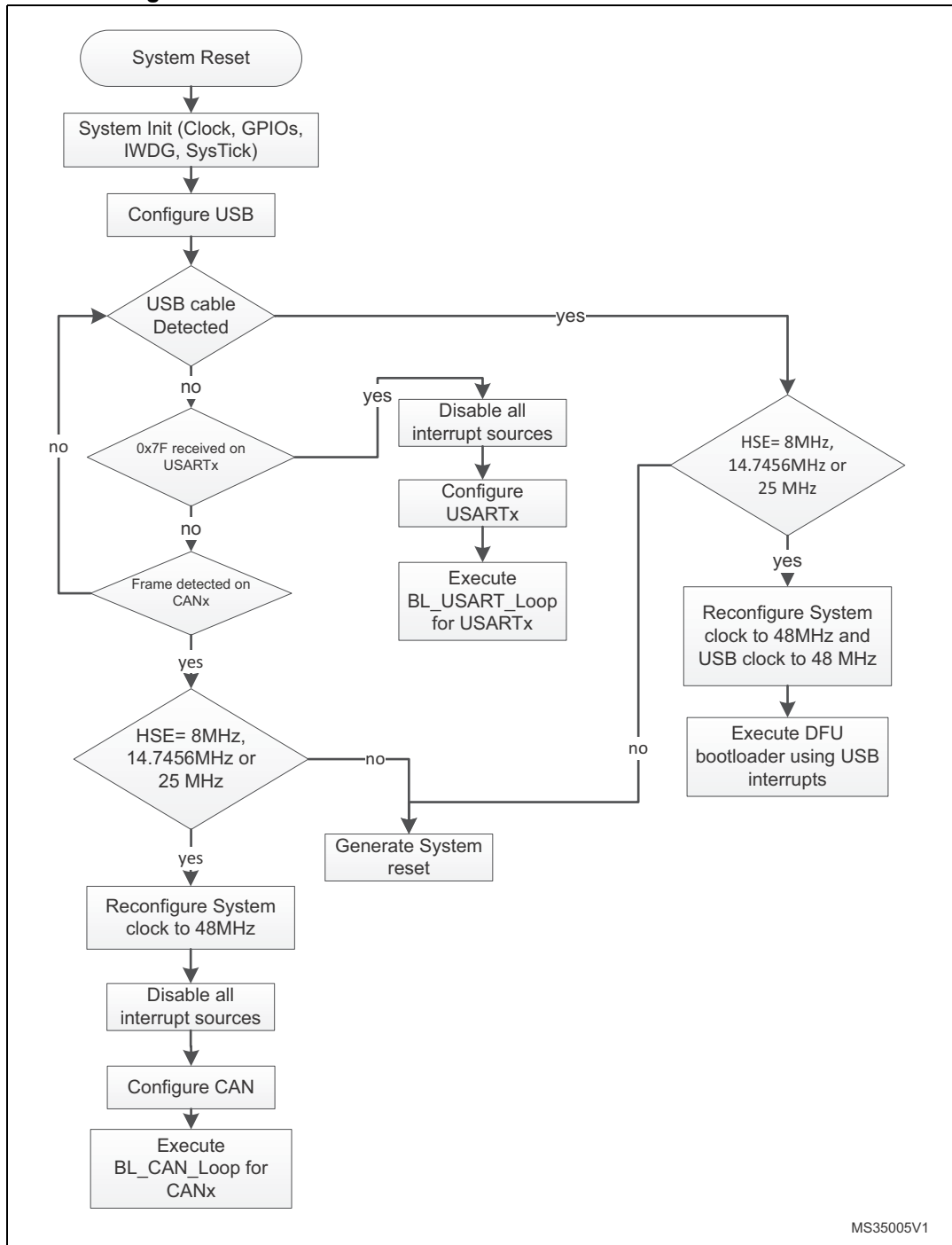

MS35005V1

14.3 Bootloader version

The following table lists the STM32F105xx/107xx devices bootloader versions:

Table 25. STM32F105xx/107xx bootloader versions

Bootloader version number	Description
V1.0	Initial bootloader version
V2.0	<ul style="list-style-type: none"> – Bootloader detection mechanism updated to fix the issue when GPIOs of unused peripherals in this bootloader are connected to low level or left floating during the detection phase. For more details please refer to Section 14.3.2. – Vector table set to 0x1FFFB000 instead of 0x00000000 – Go command updated (for all bootloaders): USART1, USART2, CAN2, GPIOA, GPIOB, GPIOD and SysTick peripheral registers are set to their default reset values – DFU bootloader: USB pending interrupt cleared before executing the Leave DFU command – DFU subprotocol version changed from V1.0 to V1.2 – Bootloader version updated to V2.0
V2.1	<ul style="list-style-type: none"> – Fixed PA9 excessive consumption described in Section 14.3.4. – Get-Version command (defined in AN3155) corrected. It returns 0x22 instead of 0x20 in bootloader V2.0. Refer to Section 14.3.3 for more details. – Bootloader version updated to V2.1
V2.2	<ul style="list-style-type: none"> – Fixed DFU option bytes descriptor (set to 'e' instead of 'g' because it is read/write and not erasable). – Fixed DFU polling timings for Flash Read/Write/Erase operations. – Robustness enhancements for DFU bootloader interface. – Updated bootloader version to V2.2.

Note: The bootloader ID format is applied to all STM32 devices families except the STM32F1xx family. The bootloader version for the STM32F1xx applies only to the embedded device's bootloader version and not to its supported protocols.

14.3.1 How to identify STM32F105xx/107xx bootloader versions

Bootloader V1.0 is implemented on devices which date code is below 937 (refer to STM32F105xx and STM32F107xx datasheet for where to find the date code on the device marking).

Bootloader V2.0 and V2.1 are implemented on devices with a date code higher or equal to 937.

Bootloader V2.2 is implemented on devices with a date code higher or equal to 227.

There are two ways to distinguish between bootloader versions:

- When using the USART bootloader, the Get-Version command defined in AN2606 and AN3155 has been corrected in V2.1 version. It returns 0x22 instead of 0x20 as in bootloader V2.0.

- The values of the vector table at the beginning of the bootloader code are different. The user software (or via JTAG/SWD) reads 0x1FFFE945 at address 0x1FFFB004 for bootloader V2.0 0x1FFFE9A1 for bootloader V2.1, and 0x1FFFE9C1 for bootloader V2.2.
- The DFU version is the following:
 - V2.1 in bootloader V2.1
 - V2.2 in bootloader V2.2.It can be read through the `bcdDevice` field of the DFU Device Descriptor.

14.3.2 Bootloader unavailability on STM32F105xx/STM32F107xx devices with a date code below 937

Description

The bootloader cannot be used if the USART1_RX (PA10), USART2_RX (PD6, remapped), CAN2_Rx (PB5, remapped), OTG_FS_DM (PA11), and/or OTG_FS_DP (PA12) pin(s) are held low or left floating during the bootloader activation phase.

The bootloader cannot be connected through CAN2 (remapped), DFU (OTG FS in Device mode), USART1 or USART2 (remapped).

On 64-pin packages, the USART2_RX signal remapped PD6 pin is not available and it is internally grounded. In this case, the bootloader cannot be used at all.

Workaround

- For 64-pin packages
None. The bootloader cannot be used.
- For 100-pin packages
Depending on the used peripheral, the pins for the unused peripherals have to be kept at a high level during the bootloader activation phase as described below:
 - If USART1 is used to connect to the bootloader, PD6 and PB5 have to be kept at a high level.
 - If USART2 is used to connect to the bootloader, PA10, PB5, PA11 and PA12 have to be kept at a high level.
 - If CAN2 is used to connect to the bootloader, PA10, PD6, PA11 and PA12 have to be kept at a high level.
 - If DFU is used to connect to the bootloader, PA10, PB5 and PD6 have to be kept at a high level.

Note: This limitation applies only to STM32F105xx and STM32F107xx devices with a date code below 937. STM32F105xx and STM32F107xx devices with a date code higher or equal to 937 are not impacted. See STM32F105xx and STM32F107xx datasheets for where to find the date code on the device marking.

14.3.3 USART bootloader Get-Version command returns 0x20 instead of 0x22

Description

In USART mode, the Get-Version command (defined in AN3155) returns 0x20 instead of 0x22.

This limitation is present on bootloader versions V1.0 and V2.0, while it is fixed in bootloader version 2.1.

Workaround

None.

14.3.4 PA9 excessive power consumption when USB cable is plugged in bootloader V2.0

Description

When connecting a USB cable after booting from System-Memory mode, PA9 pin (connected to $V_{BUS}=5\text{ V}$) is also shared with USART TX pin which is configured as alternate push-pull and forced to 0 since the USART peripheral is not yet clocked. As a consequence, a current higher than 25 mA is drained by PA9 I/O and may affect the I/O pad reliability.

This limitation is fixed in bootloader version 2.1 by configuring PA9 as alternate function push-pull when a correct 0x7F is received on RX pin and the USART is clocked. Otherwise, PA9 is configured as alternate input floating.

Workaround

None.

15 STM32F10xxx XL-density devices bootloader

15.1 Bootloader configuration

The STM32F10xxx XL-density bootloader is activated by applying pattern3 (described in [Table 2: Bootloader activation patterns](#)). The following table shows the hardware resources used by this bootloader:

Table 26. STM32F10xxx XL-density configuration in system memory boot mode

Bootloader	Feature/Peripheral	State	Comment
Common to all bootloaders	RCC	HSI enabled	The system clock frequency is 24 MHz using the PLL.
	RAM	-	2 Kbyte starting from address 0x20000000 are used by the bootloader firmware.
	System memory	-	6 Kbyte starting from address 0x1FFFE000 contain the bootloader firmware.
	IWDG	-	The independent watchdog (IWDG) prescaler is configured to its maximum value and is periodically refreshed to prevent watchdog reset (in case the hardware IWDG option was previously enabled by the user).
USART1 bootloader	USART1	Enabled	Once initialized, the USART1 configuration is: 8 bits, even parity and 1 Stop bit.
	USART1_RX pin	Input	PA10 pin: USART1 in reception mode
	USART1_TX pin	Output push-pull	PA9 pin: USART1 in transmission mode
USART2 bootloader	USART2	Enabled	Once initialized, the USART2 configuration is: 8 bits, even parity and 1 Stop bit.
	USART2_RX pin	Input	PD6 pin: USART2 receives (remapped pins).
	USART2_TX pin	Output push-pull	PD5 pin: USART2 transmits (remapped pins).
USARTx bootloaders	SysTick timer	Enabled	Used to automatically detect the serial baud rate from the host.

The system clock is derived from the embedded internal high-speed RC, no external quartz is required for the bootloader execution.

15.2 Bootloader selection

The figure below shows the bootloader selection mechanism.

Figure 16. Bootloader selection for STM32F10xxx XL-density devices

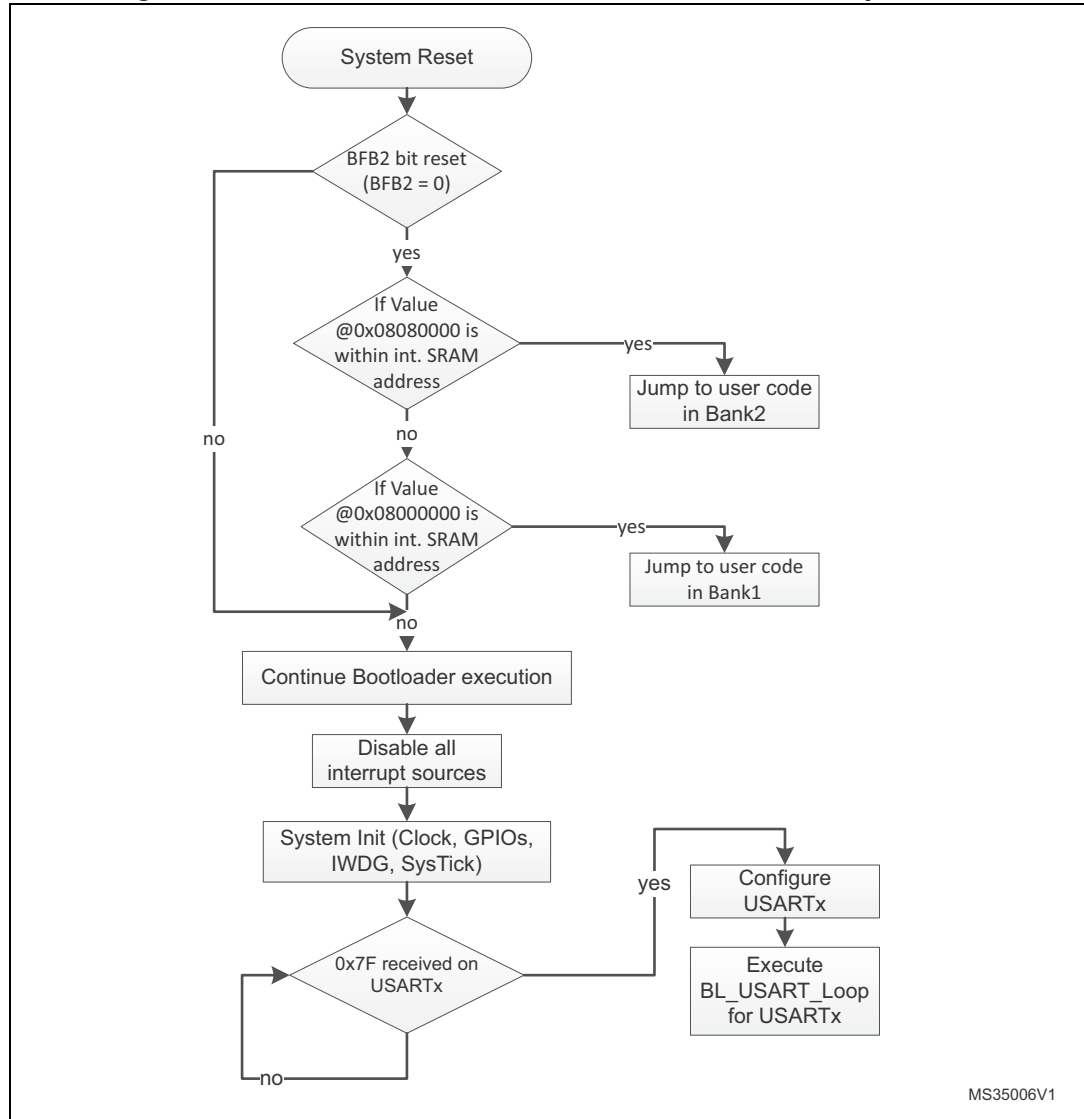

15.3 Bootloader version

The following table lists the STM32F10xxx XL-density devices bootloader versions:

Table 27. STM32F10xxx XL-density bootloader versions

Bootloader version number	Description
V2.1	Initial bootloader version

Note: The bootloader ID format is applied to all STM32 devices families except the STM32F1xx family. The bootloader version for the STM32F1xx applies only to the embedded device's bootloader version and not to its supported protocols.

16 STM32F2xxxx devices bootloader

Two bootloader versions are available on STM32F2xxxx devices:

- V2.x supporting USART1 and USART3
This version is embedded in STM32F2xxxx devices revision B.
- V3.x supporting USART1, USART3, CAN2 and DFU (USB FS Device)
This version is embedded in STM32F2xxxx devices revision X and Y.

16.1 Bootloader V2.x

16.1.1 Bootloader configuration

The STM32F2xxxx bootloader is activated by applying pattern1 (described in [Table 2: Bootloader activation patterns](#)). The following table shows the hardware resources used by this bootloader.

Table 28. STM32F2xxxx configuration in system memory boot mode

Bootloader	Feature/Peripheral	State	Comment
Common to all bootloaders	RCC	HSI enabled	The system clock frequency is 24 MHz.
	RAM	-	8 Kbyte starting from address 0x20000000.
	System memory	-	29 Kbyte starting from address 0x1FFF0000, contain the bootloader firmware.
	IWDG	-	The independent watchdog (IWDG) prescaler is configured to its maximum value and is periodically refreshed to prevent watchdog reset (in case the hardware IWDG option was previously enabled by the user).
	Power	-	Voltage range is set to [1.62 V, 2.1 V]. In this range internal Flash write operations are allowed only in byte format (Half-Word, Word and Double-Word operations are not allowed). The voltage range can be configured in run time using bootloader commands.
USART1 bootloader	USART1	Enabled	Once initialized, the USART1 configuration is: 8 bits, even parity and 1 Stop bit.
	USART1_RX pin	Input	PA10 pin: USART1 in reception mode
	USART1_TX pin	Output	PA9 pin: USART1 in transmission mode
USART3 bootloader (on PC10/PC11)	USART3	Enabled	Once initialized, the USART3 configuration is: 8 bits, even parity and 1 Stop bit.
	USART3_RX pin	Input	PC11 pin: USART3 in reception mode
	USART3_TX pin	Output	PC10 pin: USART3 in transmission mode

Table 28. STM32F2xxxx configuration in system memory boot mode (continued)

Bootloader	Feature/Peripheral	State	Comment
USART3 bootloader (on PB10/PB11)	USART3	Enabled	Once initialized, the USART3 configuration is: 8 bits, even parity and 1 Stop bit
	USART3_RX pin	Input	PB11 pin: USART3 in reception mode
	USART3_TX pin	Output	PB10 pin: USART3 in transmission mode
USARTx bootloaders	SysTick timer	Enabled	Used to automatically detect the serial baud rate from the host.

The system clock is derived from the embedded internal high-speed RC. No external quartz is required for the bootloader code.

16.1.2 Bootloader selection

The figure below shows the bootloader selection mechanism.

Figure 17. Bootloader V2.x selection for STM32F2xxxx devices

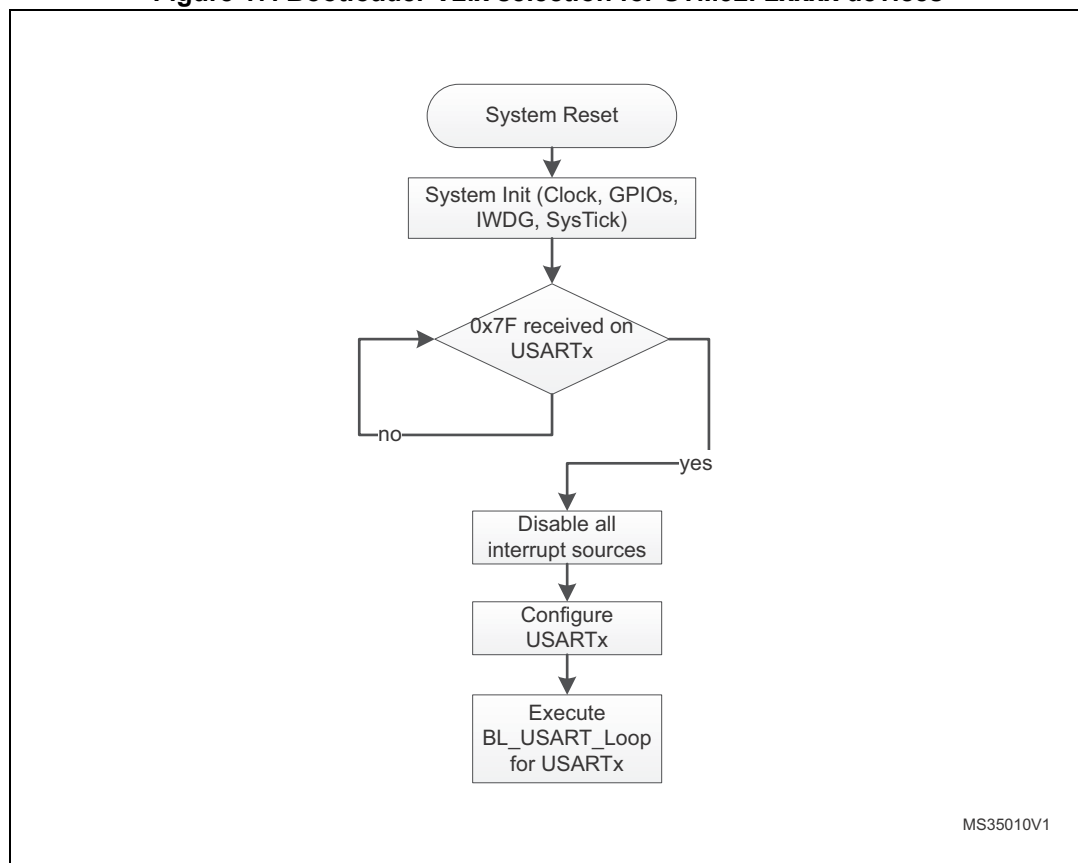

16.1.3 Bootloader version

This following table lists the STM32F2xxxx devices V2.x bootloader versions:

Table 29. STM32F2xxxx bootloader V2.x versions

Bootloader version number	Description	Known limitations
V2.0	Initial bootloader version	<p>When a Read Memory command or Write Memory command is issued with an unsupported memory address and a correct address checksum (ie. address 0x6000 0000), the command is aborted by the bootloader device, but the NACK (0x1F) is not sent to the host. As a result, the next 2 bytes (which are the number of bytes to be read/written and its checksum) are considered as a new command and its checksum.</p> <p>For the CAN interface, the Write Unprotect command is not functional. Instead you can use Write Memory command and write directly to the option bytes in order to disable the write protection.⁽¹⁾</p>

1. If the “number of data - 1” (N-1) to be read/written is not equal to a valid command code (0x00, 0x01, 0x02, 0x11, 0x21, 0x31, 0x43, 0x44, 0x63, 0x73, 0x82 or 0x92), then the limitation is not perceived from the host since the command is NACKed anyway (as an unsupported new command).

16.2 Bootloader V3.x

16.2.1 Bootloader configuration

The STM32F2xxx bootloader is activated by applying pattern1 (described in [Table 2: Bootloader activation patterns](#)). The following table shows the hardware resources used by this bootloader.

Table 30. STM32F2xxx configuration in system memory boot mode

Bootloader	Feature/Peripheral	State	Comment
Common to all bootloaders	RCC	HSI enabled	The system clock frequency is 24 MHz using the PLL. The HSI clock source is used at startup (interface detection phase) and when USARTx interfaces are selected (once CAN or DFU bootloader is selected, the clock source will be derived from the external crystal).
		HSE enabled	The system clock frequency is 60 MHz. The HSE clock source is used only when the CAN or the DFU (USB FS Device) interfaces are selected. The external clock must provide a frequency multiple of 1 MHz and ranging from 4 MHz to 26 MHz.
		-	The Clock Security System (CSS) interrupt is enabled for the CAN and DFU bootloaders. Any failure (or removal) of the external clock generates system reset.
	RAM	-	8 Kbyte starting from address 0x20000000 are used by the bootloader firmware.
	System memory	-	29 Kbyte starting from address 0x1FF00000 contain the bootloader firmware.
	IWDG	-	The independent watchdog (IWDG) prescaler is configured to its maximum value. It is periodically refreshed to prevent watchdog reset (in case the hardware IWDG option was previously enabled by the user).
	Power	-	Voltage range is set to [1.62 V, 2.1 V]. In this range internal Flash write operations are allowed only in byte format (Half-Word, Word and Double-Word operations are not allowed). The voltage range can be configured in run time using bootloader commands.

Table 30. STM32F2xxxx configuration in system memory boot mode (continued)

Bootloader	Feature/Peripheral	State	Comment
USART1 bootloader	USART1	Enabled	Once initialized, the USART1 configuration is: 8 bits, even parity and 1 Stop bit.
	USART1_RX pin	Input	PA10 pin: USART1 in reception mode
	USART1_TX pin	Output	PA9 pin: USART1 in transmission mode
USART3 bootloader (on PB10/PB11)	USART3	Enabled	Once initialized, the USART3 configuration is: 8 bits, even parity and 1 Stop bit.
	USART3_RX pin	Input	PB11 pin: USART3 in reception mode
	USART3_TX pin	Output	PB10 pin: USART3 in transmission mode
USART3 bootloader (on PC10/PC11)	USART3	Enabled	Once initialized, the USART3 configuration is: 8 bits, even parity and 1 Stop bit.
	USART3_RX pin	Input	PC11 pin: USART3 in reception mode
	USART3_TX pin	Output	PC10 pin: USART3 in transmission mode
USARTx bootloaders	SysTick timer	Enabled	Used to automatically detect the serial baud rate from the host for USARTx bootloaders.
CAN2 bootloader	CAN2	Enabled	Once initialized, the CAN2 configuration is: Baudrate 125 kbps, 11-bit identifier. Note: CAN1 is clocked during CAN2 bootloader execution because CAN1 manages the communication between CAN2 and SRAM.
	CAN2_RX pin	Input	PB5 pin: CAN2 in reception mode
	CAN2_TX pin	Output	PB13 pin: CAN2 in transmission mode
DFU bootloader	USB	Enabled	USB OTG FS configured in forced device mode
	USB_DM pin	Input/Output	PA11: USB DM line.
	USB_DP pin		PA12: USB DP line No external Pull-up resistor is required
CAN2 and DFU bootloaders	TIM11	Enabled	This timer is used to determine the value of the HSE. Once the HSE frequency is determined, the system clock is configured to 60 MHz using PLL and HSE.

The system clock is derived from the embedded internal high-speed RC for USARTx bootloaders. This internal clock is also used for CAN and DFU (USB FS Device) but only for the selection phase. An external clock multiple of 1 MHz (between 4 and 26 MHz) is required for CAN and DFU bootloader execution after the selection phase.

16.2.2 Bootloader selection

The figure below shows the bootloader selection mechanism.

Figure 18. Bootloader V3.x selection for STM32F2xxxx devices

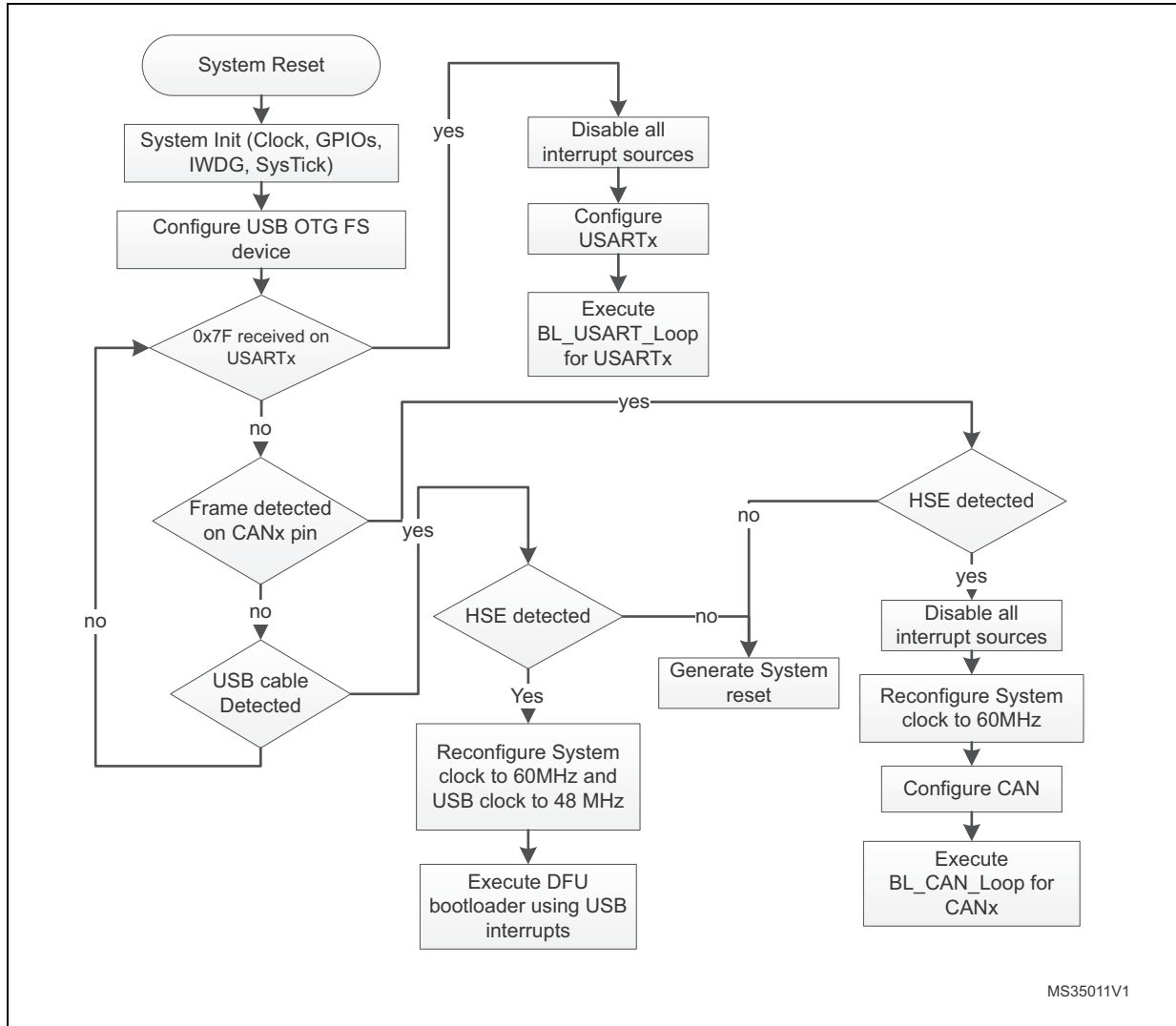

MS35011V1

16.2.3 Bootloader version

The following table lists the STM32F2xxxx devices V3.x bootloader versions:

Table 31. STM32F2xxxx bootloader V3.x versions

Bootloader version number	Description	Known limitations
V3.2	Initial bootloader version.	<ul style="list-style-type: none"> – When a Read Memory command or Write Memory command is issued with an unsupported memory address and a correct address checksum (ie. address 0x6000 0000), the command is aborted by the bootloader device, but the NACK (0x1F) is not sent to the host. As a result, the next 2 bytes (which are the number of bytes to be read/written and its checksum) are considered as a new command and its checksum⁽¹⁾. – Option bytes, OTP and Device Feature descriptors (in DFU interface) are set to “g” instead of “e” (not erasable memory areas).
V3.3	Fix V3.2 limitations. DFU interface robustness enhancement.	<ul style="list-style-type: none"> – For the USART interface, two consecutive NACKs (instead of 1 NACK) are sent when a Read Memory or Write Memory command is sent and the RDP level is active. – For the CAN interface, the Write Unprotect command is not functional. Instead you can use Write Memory command and write directly to the option bytes in order to disable the write protection.

1. If the “number of data - 1” (N-1) to be read/written is not equal to a valid command code (0x00, 0x01, 0x02, 0x11, 0x21, 0x31, 0x43, 0x44, 0x63, 0x73, 0x82 or 0x92), then the limitation is not perceived from the host since the command is NACKed anyway (as an unsupported new command).

17 STM32F301xx/302x4(6/8) devices bootloader

17.1 Bootloader configuration

The STM32F301xx/302x4(6/8) bootloader is activated by applying pattern2 (described in [Table 2: Bootloader activation patterns](#)). The following table shows the hardware resources used by this bootloader.

Table 32. STM32F301xx/302x4(6/8) configuration in system memory boot mode

Bootloader	Feature/Peripheral	State	Comment
Common to all bootloaders	RCC	HSI enabled	The system clock frequency is 48 MHz with HSI48 48 MHz as clock source.
		HSE enabled	The external clock can be used for all bootloader interfaces and should have one the following values [24, 18, 16, 12, 9, 8, 6, 4, 3] MHz. The PLL is used to generate the USB48 MHz clock and the 48 MHz clock for the system clock.
		-	The Clock Security System (CSS) interrupt is enabled for the DFU bootloader. Any failure (or removal) of the external clock generates system reset.
	RAM	-	6 Kbyte starting from address 0x20000000 are used by the bootloader firmware
	System memory	-	8 Kbyte starting from address 0x1FFFD800, contain the bootloader firmware
	IWDG	-	The independent watchdog (IWDG) prescaler is configured to its maximum value. It is periodically refreshed to prevent watchdog reset (in case the hardware IWDG option was previously enabled by the user).
USART1 bootloader	USART1	Enabled	Once initialized the USART1 configuration is: 8-bits, even parity and 1 Stop bit
	USART1_RX pin	Input	PA10 pin: USART1 in reception mode
	USART1_TX pin	Output	PA9 pin: USART1 in transmission mode
USART2 bootloader	USART2	Enabled	Once initialized the USART2 configuration is: 8-bits, even parity and 1 Stop bit
	USART2_RX pin	Input	PA3 pin: USART2 in reception mode
	USART2_TX pin	Output	PA2 pin: USART2 in transmission mode
USARTx bootloaders	SysTick timer	Enabled	Used to automatically detect the serial baud rate from the host for USARTx bootloaders.

Table 32. STM32F301xx/302x4(6/8) configuration in system memory boot mode (continued)

Bootloader	Feature/Peripheral	State	Comment
DFU bootloader	USB	Enabled	USB used in FS mode
	USB_DM pin	Input/Output	PA11: USB DM line.
	USB_DP pin		PA12: USB DP line An external pull-up resistor 1.5 KOhm must be connected to USB_DP pin.

The bootloader has two case of operation depending on the presence of the external clock (HSE) at bootloader startup:

- If HSE is present and has a value of 24, 18, 16, 12, 9, 8, 6, 4 or 3 MHz, the system clock is configured to 48 MHz with HSE as clock source. The DFU interface, USART1 and USART2 are functional and can be used to communicate with the bootloader device.
- If HSE is not present, the HSI is kept as default clock source and only USART1 and USART2 are functional.

The external clock (HSE) must be kept if it's connected at bootloader startup because it will be used as system clock source.

17.2 Bootloader selection

The figure below shows the bootloader selection mechanism.

Figure 19. Bootloader selection for STM32F301xx/302x4(6/8)

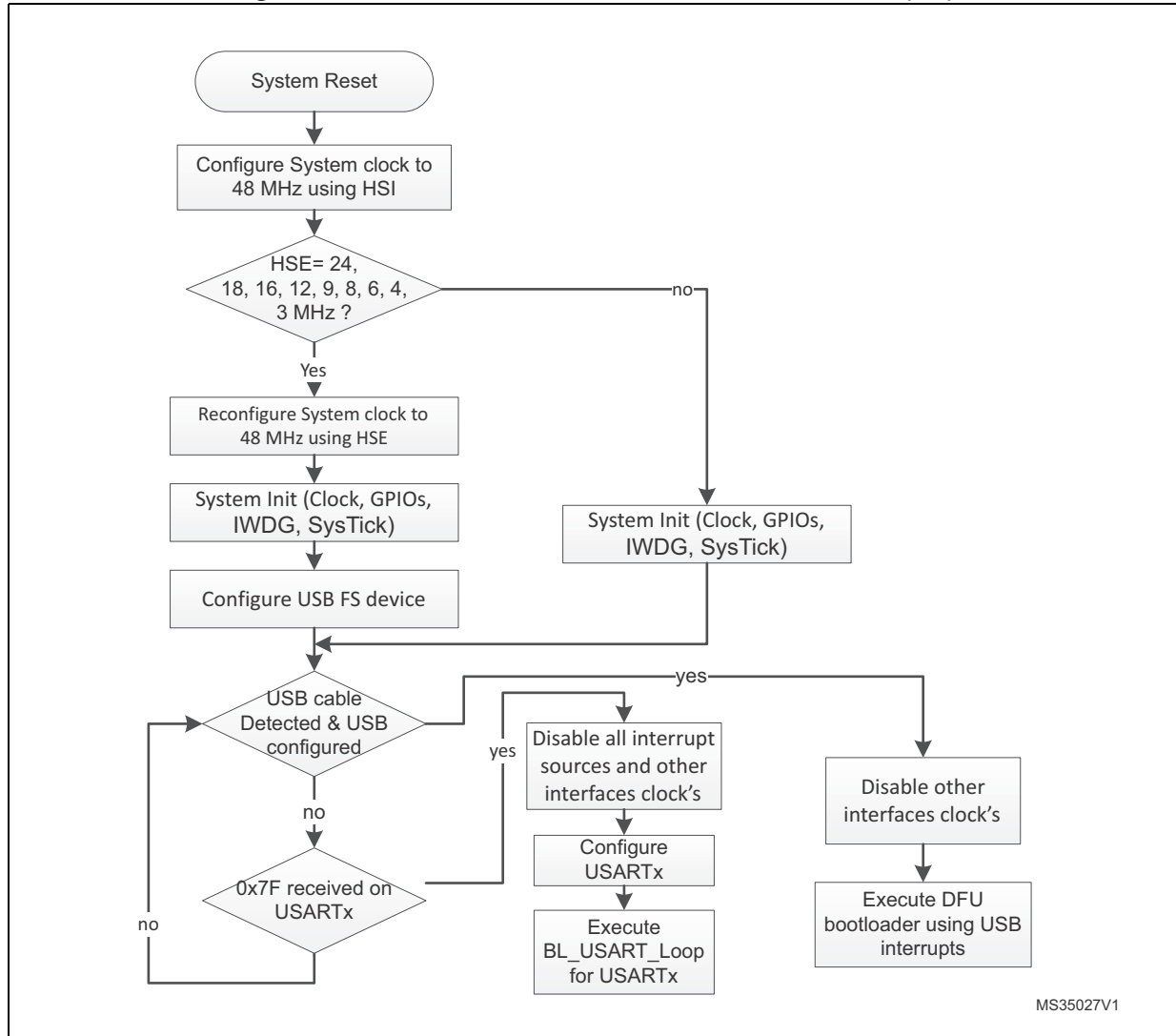

17.3 Bootloader version

The following table lists the STM32F301xx/302x4(6/8) devices bootloader versions:

Table 33. STM32F301xx/302x4(6/8) bootloader versions

Bootloader version number	Description	Known limitations
V4.0	Initial bootloader version	None

18 STM32F302xB(C)/303xB(C) devices bootloader

18.1 Bootloader configuration

The STM32F302xB(C)/303xB(C) bootloader is activated by applying pattern2 (described in [Table 2: Bootloader activation patterns](#)). The following table shows the hardware resources used by this bootloader.

Table 34. STM32F302xB(C)/303xB(C) configuration in system memory boot mode

Bootloader	Feature/Peripheral	State	Comment
Common to all bootloaders	RCC	HSI enabled	At startup, the system clock frequency is configured to 48 MHz using the HSI. If an external clock (HSE) is not present, the system is kept clocked from the HSI.
		HSE enabled	The external clock can be used for all bootloader interfaces and should have one the following values [24, 18,16, 12, 9, 8, 6, 4, 3] MHz. The PLL is used to generate the USB 48 MHz clock and the 48 MHz clock for the system clock.
		-	The Clock Security System (CSS) interrupt is enabled for the DFU bootloader. Any failure (or removal) of the external clock generates system reset.
	RAM	-	5 Kbyte starting from address 0x20000000 are used by the bootloader firmware.
	System memory	-	8 Kbyte starting from address 0x1FFFD800, contains the bootloader firmware.
	IWDG	-	The independent watchdog (IWDG) prescaler is configured to its maximum value and is periodically refreshed to prevent watchdog reset (in case the hardware IWDG option was previously enabled by the user).
USART1 bootloader	USART1	Enabled	Once initialized, the USART1 configuration is: 8 bits, even parity and 1 Stop bit.
	USART1_RX pin	Input	PA10 pin: USART1 in reception mode
	USART1_TX pin	Output	PA9 pin: USART1 in transmission mode
USART2 bootloader	USART2	Enabled	Once initialized, the USART2 configuration is: 8 bits, even parity and 1 Stop bit. The USART2 uses its remapped pins.
	USART2_RX pin	Input	PD6 pin: USART2 in reception mode
	USART2_TX pin	Output	PD5 pin: USART2 in transmission mode
USARTx bootloaders	SysTick timer	Enabled	Used to automatically detect the serial baud rate from the host for USARTx bootloader.

Table 34. STM32F302xB(C)/303xB(C) configuration in system memory boot mode (continued)

Bootloader	Feature/Peripheral	State	Comment
DFU bootloader	USB	Enabled	USB used in FS mode
	USB_DM pin	Input/Output	PA11: USB DM line.
	USB_DP pin		PA12: USB DP line An external pull-up resistor 1.5 KOhm must be connected to USB_DP pin.

The bootloader has two case of operation depending on the presence of the external clock (HSE) at bootloader startup:

- If HSE is present and has a value of 24, 18, 16, 12, 9, 8, 6, 4 or 3 MHz, the system clock is configured to 48 MHz with HSE as clock source. The DFU interface, USART1 and USART2 are functional and can be used to communicate with the bootloader device.
- If HSE is not present, the HSI is kept as default clock source and only USART1 and USART2 are functional.

The external clock (HSE) must be kept if it's connected at bootloader startup because it will be used as system clock source.

18.2 Bootloader selection

The figure below shows the bootloader selection mechanism.

Figure 20. Bootloader selection for STM32F302xB(C)/303xB(C) devices

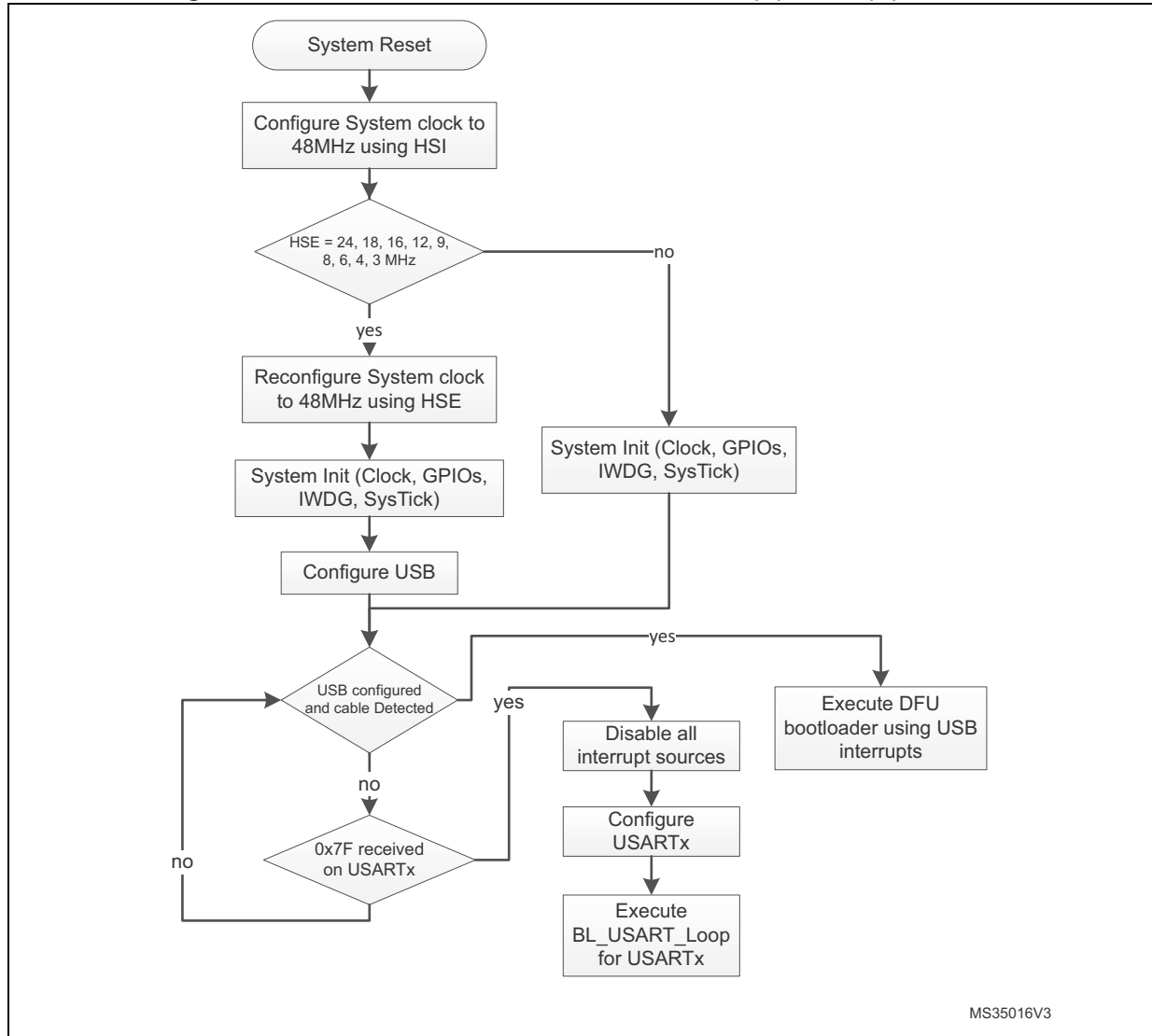

MS35016V3

18.3 Bootloader version

The following table lists the STM32F302xB(C)/303xB(C) devices bootloader versions.

Table 35. STM32F302xB(C)/303xB(C) bootloader versions

Bootloader version number	Description	Known limitations
V4.1	Initial bootloader version	None

19 STM32F302xD(E)/303xD(E) devices bootloader

19.1 Bootloader configuration

The STM32F302xD(E)/303xD(E) bootloader is activated by applying pattern2 (described in [Table 2: Bootloader activation patterns](#)). The following table shows the hardware resources used by this bootloader.

Table 36. STM32F302xD(E)/303xD(E) configuration in system memory boot mode

Bootloader	Feature/Peripheral	State	Comment
Common to all bootloaders	RCC	HSI enabled	The system clock frequency is 48 MHz with HSI48 48 MHz as clock source.
		HSE enabled	The external clock can be used for all bootloader interfaces and should have one of the following values [24, 18, 16, 12, 9, 8, 6, 4, 3] MHz. The PLL is used to generate the USB 48 MHz clock and the 48 MHz clock for the system clock.
		-	The Clock Security System (CSS) interrupt is enabled for the DFU bootloader. Any failure (or removal) of the external clock generates system reset.
	RAM	-	6 Kbyte starting from address 0x20000000 are used by the bootloader firmware
	System memory	-	8 Kbyte starting from address 0x1FFFD800, contain the bootloader firmware
	IWDG	-	The independent watchdog (IWDG) prescaler is configured to its maximum value. It is periodically refreshed to prevent watchdog reset (in case the hardware IWDG option was previously enabled by the user).
USART1 bootloader	USART1	Enabled	Once initialized the USART1 configuration is: 8-bits, even parity and 1 Stop bit
	USART1_RX pin	Input	PA10 pin: USART1 in reception mode
	USART1_TX pin	Output	PA9 pin: USART1 in transmission mode
USART2 bootloader	USART2	Enabled	Once initialized the USART2 configuration is: 8-bits, even parity and 1 Stop bit
	USART2_RX pin	Input	PA3 pin: USART2 in reception mode
	USART2_TX pin	Output	PA2 pin: USART2 in transmission mode
USARTx bootloaders	SysTick timer	Enabled	Used to automatically detect the serial baud rate from the host for USARTx bootloaders.
DFU bootloader	USB	Enabled	USB FS configured in forced device mode. USB FS interrupt vector is enabled and used for USB DFU communications.
	USB_DM pin	Input/Output	PA11 pin: USB FS DM line.
	USB_DP pin		PA12 pin: USB FS DP line. An external pull-up resistor 1.5 KOhm must be connected to USB_DP pin.

The bootloader has two cases of operation depending on the presence of the external clock (HSE) at bootloader startup:

- If HSE is present and has a value of 24, 18, 16, 12, 9, 8, 6, 4 or 3 MHz, the system clock is configured to 48 MHz with HSE as clock source. The DFU interface, USART1 and USART2 are functional and can be used to communicate with the bootloader device.
- If HSE is not present, the HSI is kept as default clock source and only USART1 and USART2 are functional.

The external clock (HSE) must be kept if it's connected at bootloader startup because it will be used as system clock source.

19.2 Bootloader selection

The figure below shows the bootloader selection mechanism.

Figure 21. Bootloader selection for STM32F302xD(E)/303xD(E)

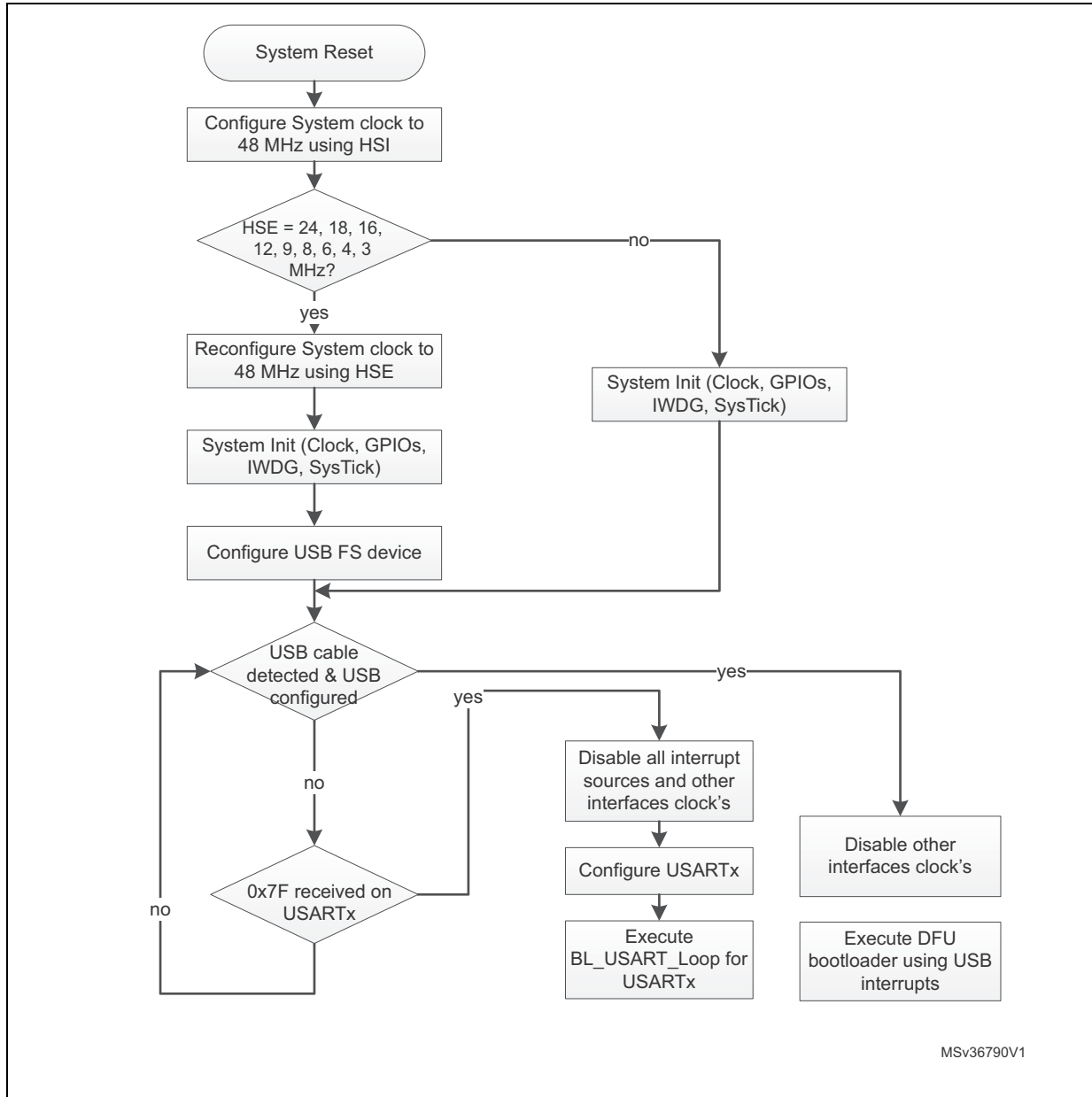

MSv36790V1

19.3 Bootloader version

The following table lists the STM32F302xD(E)/303xD(E) devices bootloader versions.

Table 37. STM32F302xD(E)/303xD(E) bootloader versions

Bootloader version number	Description	Known limitations
V4.0	Initial bootloader version	None

20 STM32F303x4(6/8)/334xx/328xx devices bootloader

20.1 Bootloader configuration

The STM32F303x4(6/8)/334xx/328xx bootloader is activated by applying pattern2 (described in [Table 2: Bootloader activation patterns](#)). The following table shows the hardware resources used by this bootloader.

Table 38. STM32F303x4(6/8)/334xx/328xx configuration in system memory boot mode

Bootloader	Feature/Peripheral	State	Comment
Common to all bootloaders	RCC	HSI enabled	The system clock frequency is 60 MHz with HSI 8 MHz as clock source.
	RAM	-	6 Kbyte starting from address 0x20000000 are used by the bootloader firmware
	System memory	-	8 Kbyte starting from address 0x1FFFD800, contain the bootloader firmware
	IWDG	-	The independent watchdog (IWDG) prescaler is configured to its maximum value. It is periodically refreshed to prevent watchdog reset (in case the hardware IWDG option was previously enabled by the user).
USART1 bootloader	USART1	Enabled	Once initialized the USART1 configuration is: 8-bits, even parity and 1 Stop bit
	USART1_RX pin	Input	PA10 pin: USART1 in reception mode
	USART1_TX pin	Output	PA9 pin: USART1 in transmission mode
USART2 bootloader	USART2	Enabled	Once initialized the USART2 configuration is: 8-bits, even parity and 1 Stop bit
	USART2_RX pin	Input	PA3 pin: USART2 in reception mode
	USART2_TX pin	Output	PA2 pin: USART2 in transmission mode
USARTx bootloaders	SysTick timer	Enabled	Used to automatically detect the serial baud rate from the host for USARTx bootloaders.
I2C1 bootloader	I2C1	Enabled	The I2C1 configuration is: I2C speed: up to 400 KHz, 7-bit address, slave mode, analog filter ON. Slave 7-bit address: 0b0111111x (where x = 0 for write and x = 1 for read)
	I2C1_SCL pin	Input/Output	PB6 pin: clock line is used in open-drain mode.
	I2C1_SDA pin	Input/Output	PB7 pin: data line is used in open-drain mode.

The system clock is derived from the embedded internal high-speed RC, no external quartz is required for the bootloader execution.

20.2 Bootloader selection

The figure below shows the bootloader selection mechanism.

Figure 22. Bootloader selection for STM32F303x4(6/8)/334xx/328xx

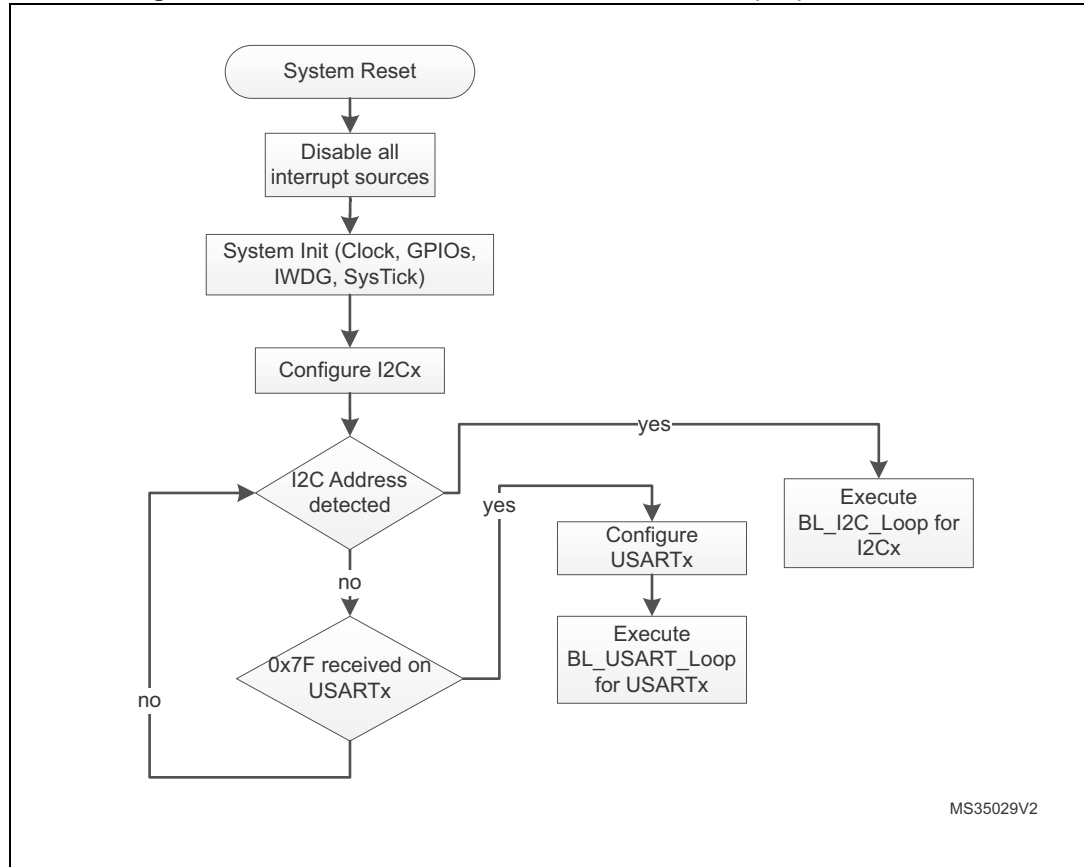

20.3 Bootloader version

The following table lists the STM32F303x4(6/8)/334xx/328xx devices bootloader versions:

Table 39. STM32F303x4(6/8)/334xx/328xx bootloader versions

Bootloader version number	Description	Known limitations
V5.0	Initial bootloader version	None

21 STM32F318xx devices bootloader

21.1 Bootloader configuration

The STM32F318xx bootloader is activated by applying pattern2 (described in [Table 2: Bootloader activation patterns](#)). The following table shows the hardware resources used by this bootloader.

Table 40. STM32F318xx configuration in system memory boot mode

Bootloader	Feature/Peripheral	State	Comment
Common to all bootloaders	RCC	HSI enabled	The system clock frequency is 60 MHz with HSI 8 MHz as clock source.
	RAM	-	6 Kbyte starting from address 0x20000000 are used by the bootloader firmware
	System memory	-	8 Kbyte starting from address 0x1FFFD800, contain the bootloader firmware
	IWDG	-	The independent watchdog (IWDG) prescaler is configured to its maximum value. It is periodically refreshed to prevent watchdog reset (in case the hardware IWDG option was previously enabled by the user).
USART1 bootloader	USART1	Enabled	Once initialized the USART1 configuration is: 8-bits, even parity and 1 Stop bit
	USART1_RX pin	Input	PA10 pin: USART1 in reception mode
	USART1_TX pin	Output	PA9 pin: USART1 in transmission mode
USART2 bootloader	USART2	Enabled	Once initialized the USART2 configuration is: 8-bits, even parity and 1 Stop bit
	USART2_RX pin	Input	PA3 pin: USART2 in reception mode
	USART2_TX pin	Output	PA2 pin: USART2 in transmission mode
USARTx bootloaders	SysTick timer	Enabled	Used to automatically detect the serial baud rate from the host for USARTx bootloaders.
I2C1 bootloader	I2C1	Enabled	The I2C1 configuration is: I2C speed: up to 400 KHz, 7-bit address, slave mode, analog filter ON. Slave 7-bit address: 0b0111101x (where x = 0 for write and x = 1 for read)
	I2C1_SCL pin	Input/Output	PB6 pin: clock line is used in open-drain mode.
	I2C1_SDA pin	Input/Output	PB7 pin: data line is used in open-drain mode.

Table 40. STM32F318xx configuration in system memory boot mode (continued)

Bootloader	Feature/Peripheral	State	Comment
I2C3 bootloader	I2C3	Enabled	The I2C3 configuration is: I2C speed: up to 400 KHz, 7-bit address, slave mode, analog filter ON. Slave 7-bit address: 0b0111101x (where x = 0 for write and x = 1 for read) and digital filter disabled.
	I2C3_SCL pin	Input/Output	PA8 pin: clock line is used in open-drain mode.
	I2C3_SDA pin	Input/Output	PB5 pin: data line is used in open-drain mode.

The system clock is derived from the embedded internal high-speed RC, no external quartz is required for the bootloader execution.

21.2 Bootloader selection

The figure below shows the bootloader selection mechanism.

Figure 23. Bootloader selection for STM32F318xx

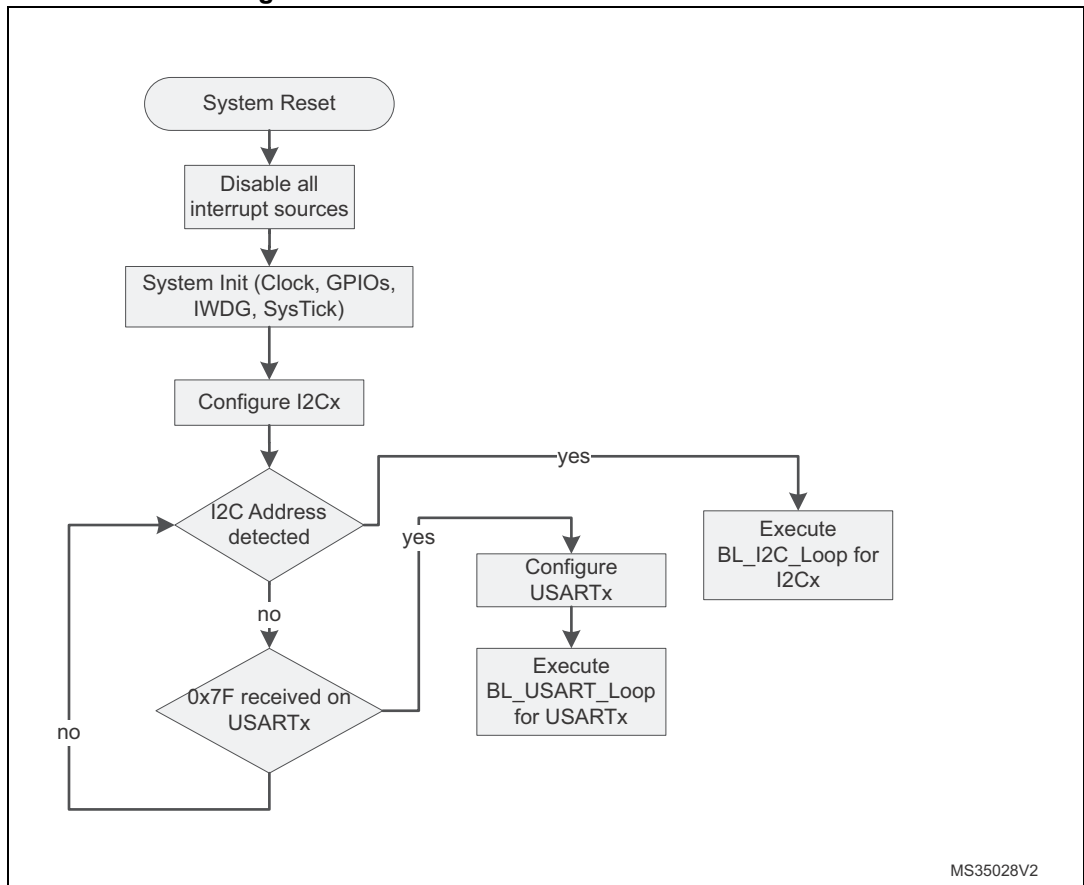

21.3 Bootloader version

The following table lists the STM32F318xx devices bootloader versions:

Table 41. STM32F318xx bootloader versions

Bootloader version number	Description	Known limitations
V5.0	Initial bootloader version	None

22 STM32F358xx devices bootloader

22.1 Bootloader configuration

The STM32F358xx bootloader is activated by applying pattern2 (described in [Table 2: Bootloader activation patterns](#)). The following table shows the hardware resources used by this bootloader.

Table 42. STM32F358xx configuration in system memory boot mode

Bootloader	Feature/Peripheral	State	Comment
Common to all bootloaders	RCC	HSI enabled	The system clock frequency is 8 MHz using the HSI.
	RAM	-	5 Kbyte starting from address 0x20000000 are used by the bootloader firmware.
	System memory	-	8 Kbyte starting from address 0x1FFFD800, contains the bootloader firmware.
	IWDG	-	The independent watchdog (IWDG) prescaler is configured to its maximum value and is periodically refreshed to prevent watchdog reset (in case the hardware IWDG option was previously enabled by the user). Window feature is disabled.
USART1 bootloader	USART1	Enabled	Once initialized, the USART1 configuration is: 8 bits, even parity and 1 Stop bit.
	USART1_RX pin	Input	PA10 pin: USART1 in reception mode.
	USART1_TX pin	Output	PA9 pin: USART1 in transmission mode.
USART2 bootloader	USART2	Enabled	Once initialized, the USART2 configuration is: 8 bits, even parity and 1 Stop bit. The USART2 uses its remapped pins.
	USART2_RX pin	Input	PD6 pin: USART2 in reception mode.
	USART2_TX pin	Output	PD5 pin: USART2 in transmission mode.
USARTx bootloaders	SysTick timer	Enabled	Used to automatically detect the serial baud rate from the host for USARTx bootloader.
I2C1 bootloader	I2C1	Enabled	The I2C1 configuration is: I2C speed: up to 400 KHz, 7-bit address, slave mode, analog filter ON. Slave 7-bit address: 0b0110111x (where x = 0 for write and x = 1 for read)
	I2C1_SCL pin	Input/Output	PB6 pin: clock line is used in open-drain mode.
	I2C1_SDA pin	Input/Output	PB7 pin: data line is used in open-drain mode.

The system clock is derived from the embedded internal high-speed RC, no external quartz is required for the bootloader execution.

22.2 Bootloader selection

The figure below shows the bootloader selection mechanism.

Figure 24. Bootloader selection for STM32F358xx devices

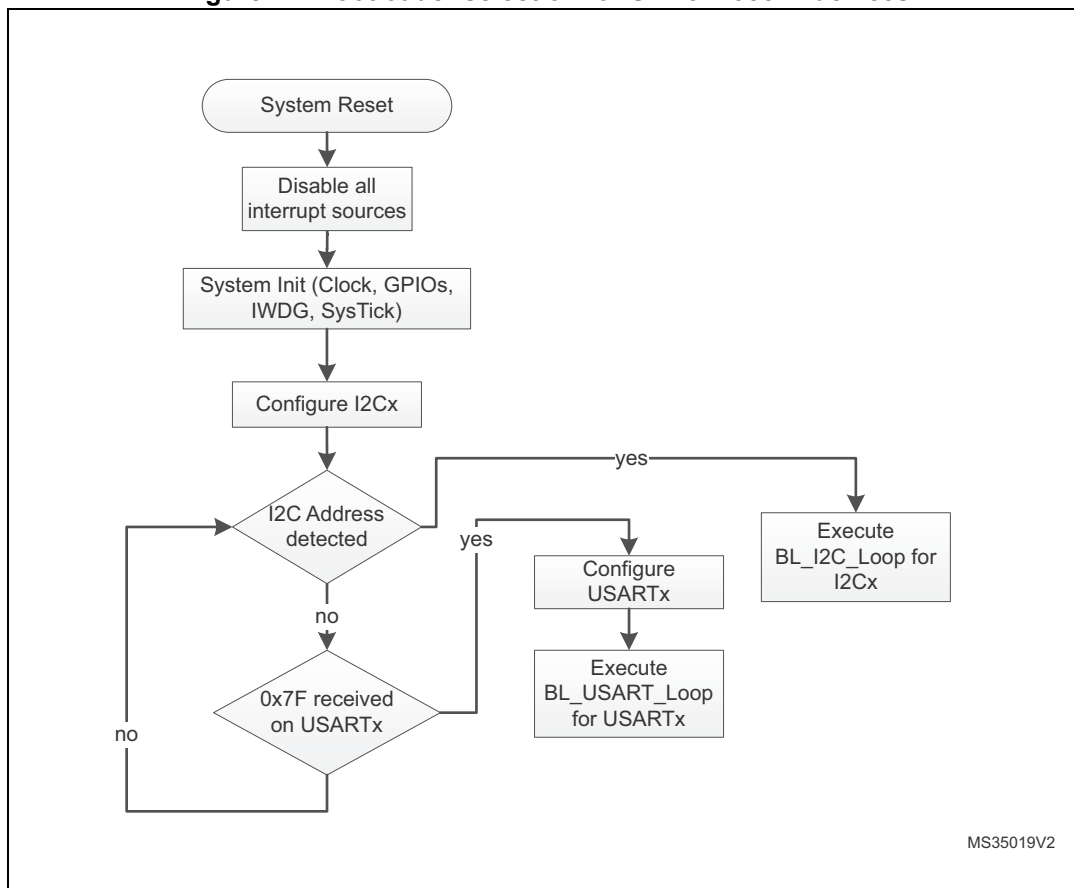

MS35019V2

22.3 Bootloader version

The following table lists the STM32F358xx devices bootloader versions.

Table 43. STM32F358xx bootloader versions

Bootloader version number	Description	Known limitations
V5.0	Initial bootloader version	For USART1 and USART2 interfaces, the maximum baudrate supported by the bootloader is 57600 baud.

23 STM32F373xx devices bootloader

23.1 Bootloader configuration

The STM32F373xx bootloader is activated by applying pattern2 (described in [Table 2: Bootloader activation patterns](#)). The following table shows the hardware resources used by this bootloader.

Table 44. STM32F373xx configuration in system memory boot mode

Bootloader	Feature/Peripheral	State	Comment
Common to all bootloaders	RCC	HSI enabled	At startup, the system clock frequency is configured to 48 MHz using the HSI. If an external clock (HSE) is not present, the system is kept clocked from the HSI.
		HSE enabled	The external clock can be used for all bootloader interfaces and should have one the following values [24, 18, 16, 12, 9, 8, 6, 4, 3] MHz. The PLL is used to generate the USB 48 MHz clock and the 48 MHz clock for the system clock.
		-	The Clock Security System (CSS) interrupt is enabled for the DFU bootloader. Any failure (or removal) of the external clock generates system reset.
	RAM	-	5 Kbyte starting from address 0x20000000 are used by the bootloader firmware.
	System memory	-	8 Kbyte starting from address 0x1FFFD800, contains the bootloader firmware
	IWDG	-	The independent watchdog (IWDG) prescaler is configured to its maximum value and is periodically refreshed to prevent watchdog reset (in case the hardware IWDG option was previously enabled by the user).
USART1 bootloader	USART1	Enabled	Once initialized, the USART1 configuration is: 8 bits, even parity and 1 Stop bit.
	USART1_RX pin	Input	PA10 pin: USART1 in reception mode
	USART1_TX pin	Output	PA9 pin: USART1 in transmission mode
USART2 bootloader	USART2	Enabled	Once initialized, the USART2 configuration is: 8 bits, even parity and 1 Stop bit. The USART2 uses its remapped pins.
	USART2_RX pin	Input	PD6 pin: USART2 in reception mode
	USART2_TX pin	Output	PD5 pin: USART2 in transmission mode
USARTx bootloaders	SysTick timer	Enabled	Used to automatically detect the serial baud rate from the host for USARTx bootloader.

Table 44. STM32F373xx configuration in system memory boot mode (continued)

Bootloader	Feature/Peripheral	State	Comment
DFU bootloader	USB	Enabled	USB used in FS mode
	USB_DM pin	Input/Output	PA11: USB DM line.
	USB_DP pin		PA12: USB DP line An external pull-up resistor 1.5 KOhm must be connected to USB_DP pin.

The bootloader has two case of operation depending on the presence of the external clock (HSE) at bootloader startup:

- If HSE is present and has a value of 24, 18, 16, 12, 9, 8, 6, 4 or 3 MHz, the system clock is configured to 48 MHz with HSE as clock source. The DFU interface, USART1 and USART2 are functional and can be used to communicate with the bootloader device.
- If HSE is not present, the HSI is kept as default clock source and only USART1 and USART2 are functional.

Note: The external clock (HSE) must be kept if it's connected at bootloader startup because it will be used as system clock source.

23.2 Bootloader selection

The figure below shows the bootloader selection mechanism.

Figure 25. Bootloader selection for STM32F373xx devices

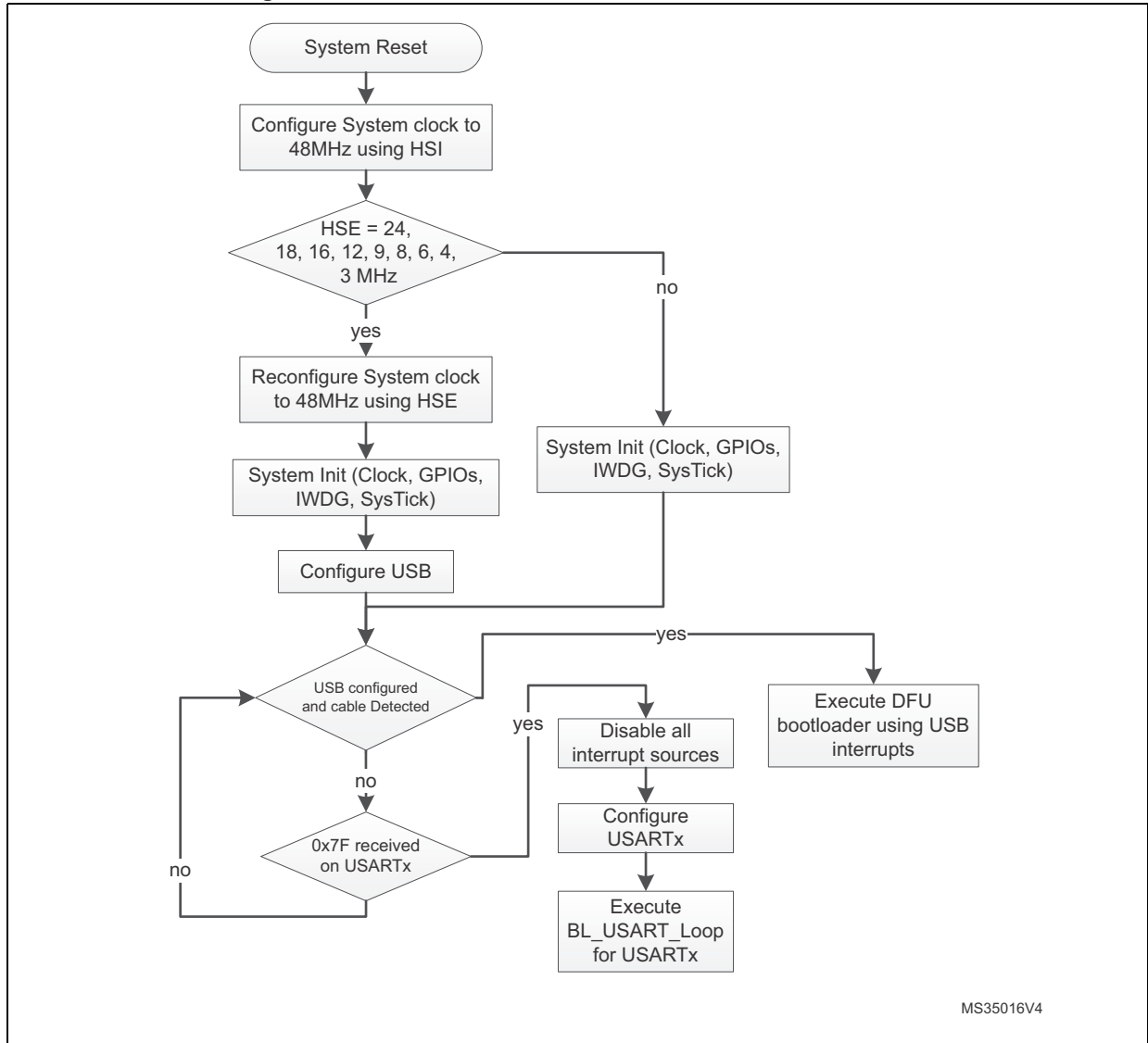

23.3 Bootloader version

The following table lists the STM32F373xx devices bootloader versions.

Table 45. STM32F373xx bootloader versions

Bootloader version number	Description	Known limitations
V4.1	Initial bootloader version	None

24 STM32F378xx devices bootloader

24.1 Bootloader configuration

The STM32F378xx bootloader is activated by applying pattern2 (described in [Table 2: Bootloader activation patterns](#)). The following table shows the hardware resources used by this bootloader.

Table 46. STM32F378xx configuration in system memory boot mode

Bootloader	Feature/Peripheral	State	Comment
Common to all bootloaders	RCC	HSI enabled	The system clock frequency is 8 MHz using the HSI.
	RAM	-	4 Kbyte starting from address 0x20000000 are used by the bootloader firmware.
	System memory	-	8 Kbyte starting from address 0x1FFFD800, contains the bootloader firmware
	IWDG	-	The independent watchdog (IWDG) prescaler is configured to its maximum value and is periodically refreshed to prevent watchdog reset (in case the hardware IWDG option was previously enabled by the user). Window feature is disabled.
USART1 bootloader	USART1	Enabled	Once initialized, the USART1 configuration is: 8 bits, even parity and 1 Stop bit
	USART1_RX pin	Input	PA10 pin: USART1 in reception mode.
	USART1_TX pin	Output	PA9 pin: USART1 in transmission mode.
USART2 bootloader	USART2	Enabled	Once initialized, the USART2 configuration is: 8 bits, even parity and 1 Stop bit. The USART2 uses its remapped pins.
	USART2_RX pin	Input	PD6 pin: USART2 in reception mode.
	USART2_TX pin	Output	PD5 pin: USART2 in transmission mode.
USARTx bootloaders	SysTick timer	Enabled	Used to automatically detect the serial baud rate from the host for USARTx bootloader.
I2C1 bootloader	I2C1	Enabled	The I2C1 configuration is: I2C speed: up to 400 KHz, 7-bit address, slave mode, analog filter ON. Slave 7-bit address: 0b0110111x (where x = 0 for write and x = 1 for read).
	I2C1_SCL pin	Input/Output	PB6 pin: clock line is used in open-drain mode.
	I2C1_SDA pin	Input/Output	PB7 pin: data line is used in open-drain mode.

The system clock is derived from the embedded internal high-speed RC, no external quartz is required for the bootloader execution.

24.2 Bootloader selection

The figure below shows the bootloader selection mechanism.

Figure 26. Bootloader selection for STM32F378xx devices

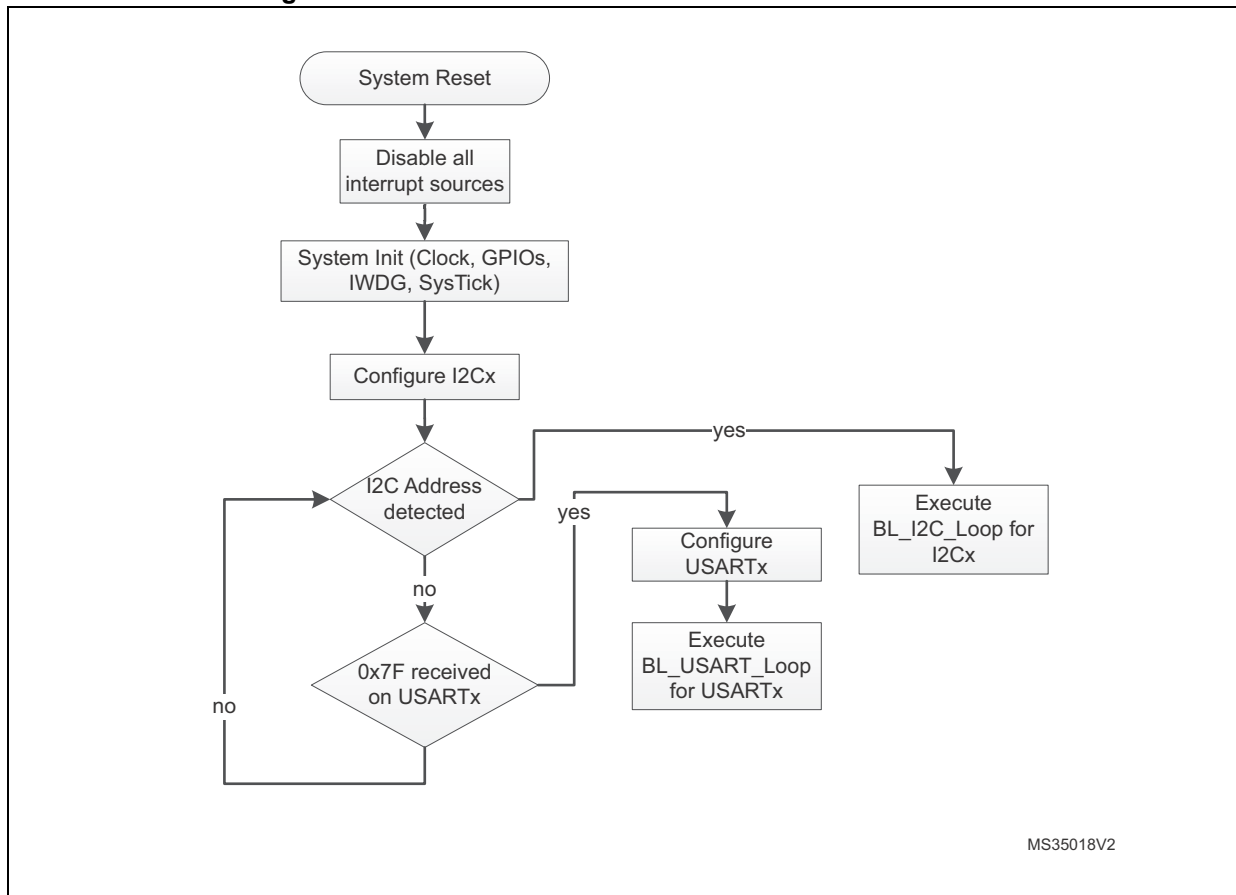

24.3 Bootloader version

The following table lists the STM32F378xx devices bootloader versions.

Table 47. STM32F378xx bootloader versions

Bootloader version number	Description	Known limitations
V5.0	Initial bootloader version	For USART1 and USART2 interfaces, the maximum baudrate supported by the bootloader is 57600 baud.

25 STM32F398xx devices bootloader

25.1 Bootloader configuration

The STM32F398xx bootloader is activated by applying pattern2 (described in [Table 2: Bootloader activation patterns](#)). The following table shows the hardware resources used by this bootloader.

Table 48. STM32F398xx configuration in system memory boot mode

Bootloader	Feature/Peripheral	State	Comment
Common to all bootloaders	RCC	HSI enabled	The system clock frequency is 60 MHz with HSI 8 MHz as clock source.
	RAM	-	6 Kbyte starting from address 0x20000000 are used by the bootloader firmware
	System memory	-	7 Kbyte starting from address 0x1FFFD800, contain the bootloader firmware
	IWDG	-	The independent watchdog (IWDG) prescaler is configured to its maximum value. It is periodically refreshed to prevent watchdog reset (in case the hardware IWDG option was previously enabled by the user).
USART1 bootloader	USART1	Enabled	Once initialized the USART1 configuration is: 8-bits, even parity and 1 Stop bit
	USART1_RX pin	Input	PA10 pin: USART1 in reception mode
	USART1_TX pin	Output	PA9 pin: USART1 in transmission mode
USART2 bootloader	USART2	Enabled	Once initialized the USART2 configuration is: 8-bits, even parity and 1 Stop bit
	USART2_RX pin	Input	PA3 pin: USART2 in reception mode
	USART2_TX pin	Output	PA2 pin: USART2 in transmission mode
USARTx bootloaders	SysTick timer	Enabled	Used to automatically detect the serial baud rate from the host for USARTx bootloaders.
I2C1 bootloader	I2C1	Enabled	The I2C1 configuration is: I2C speed: up to 400 KHz, 7-bit address, slave mode, analog filter ON. Slave 7-bit address: 0b1000000x (where x = 0 for write and x = 1 for read).
	I2C1_SCL pin	Input/Output	PB6 pin: clock line is used in open-drain mode.
	I2C1_SDA pin	Input/Output	PB7 pin: data line is used in open-drain mode.
I2C3 bootloader	I2C3	Enabled	The I2C3 configuration is: I2C speed: up to 400 KHz, 7-bit address, slave mode, analog filter ON. Slave 7-bit address: 0b1000000x (where x = 0 for write and x = 1 for read).
	I2C3_SCL pin	Input/Output	PA8 pin: clock line is used in open-drain mode.
	I2C3_SDA pin	Input/Output	PB5 pin: data line is used in open-drain mode.

The system clock is derived from the embedded internal high-speed RC for all bootloader interfaces. No external quartz is required for bootloader operations.

25.2 Bootloader selection

The figure below shows the bootloader selection mechanism.

Figure 27.Bootloader selection for STM32F398xx

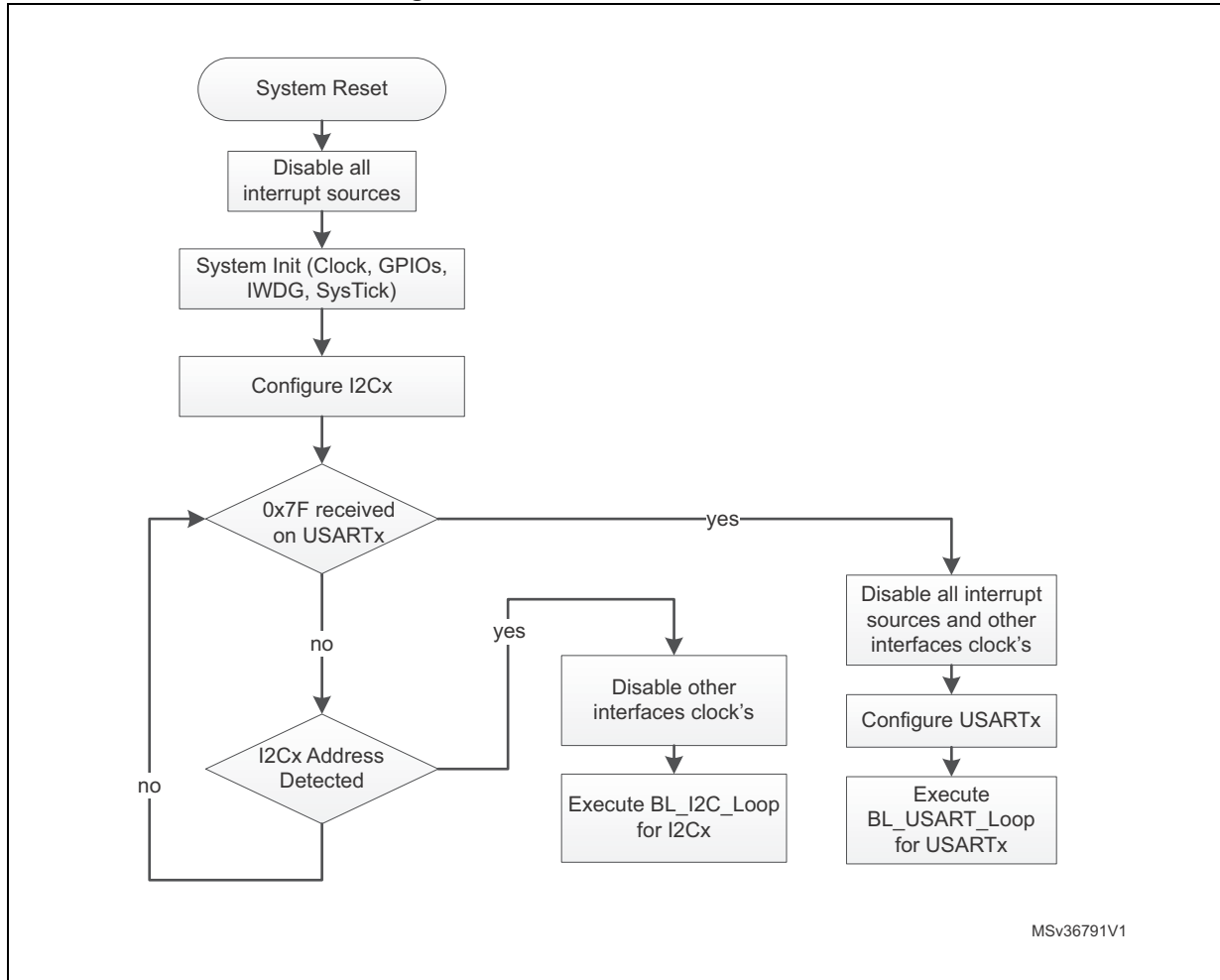

25.3 Bootloader version

The following table lists the STM32F398xx devices bootloader versions.

Table 49.STM32F398xx bootloader versions

Bootloader version number	Description	Known limitations
V5.0	Initial bootloader version	None

26 STM32F40xxx/41xxx devices bootloader

26.1 Bootloader V3.x

26.1.1 Bootloader configuration

The STM32F40xxx/41xxx bootloader is activated by applying pattern1 (described in [Table 2: Bootloader activation patterns](#)). The following table shows the hardware resources used by this bootloader.

Table 50. STM32F40xxx/41xxx configuration in system memory boot mode

Bootloader	Feature/Peripheral	State	Comment
Common to all bootloaders	RCC	HSI enabled	The system clock frequency is 24 MHz using the PLL. The HSI clock source is used at startup (interface detection phase) and when USARTx interfaces are selected (once CAN or DFU bootloader is selected, the clock source will be derived from the external crystal).
		HSE enabled	The system clock frequency is 60 MHz. The HSE clock source is used only when the CAN or the DFU (USB FS Device) interfaces are selected. The external clock must provide a frequency multiple of 1 MHz and ranging from 4 MHz to 26 MHz.
		-	The Clock Security System (CSS) interrupt is enabled for the CAN and DFU bootloaders. Any failure (or removal) of the external clock generates system reset.
	RAM	-	8 Kbyte starting from address 0x20000000 are used by the bootloader firmware.
	System memory	-	29 Kbyte starting from address 0x1FFF0000 contain the bootloader firmware.
	IWDG	-	The independent watchdog (IWDG) prescaler is configured to its maximum value. It is periodically refreshed to prevent watchdog reset (in case the hardware IWDG option was previously enabled by the user).
	Power	-	Voltage range is set to [1.62 V, 2.1 V]. In this range internal Flash write operations are allowed only in byte format (Half-Word, Word and Double-Word operations are not allowed). The voltage range can be configured in run time using bootloader commands.

Table 50. STM32F40xxx/41xxx configuration in system memory boot mode (continued)

Bootloader	Feature/Peripheral	State	Comment
USART1 bootloader	USART1	Enabled	Once initialized, the USART1 configuration is: 8 bits, even parity and 1 Stop bit.
	USART1_RX pin	Input	PA10 pin: USART1 in reception mode
	USART1_TX pin	Output	PA9 pin: USART1 in transmission mode
USART3 bootloader (on PB10/PB11)	USART3	Enabled	Once initialized, the USART3 configuration is: 8 bits, even parity and 1 Stop bit.
	USART3_RX pin	Input	PB11 pin: USART3 in reception mode
	USART3_TX pin	Output	PB10 pin: USART3 in transmission mode
USART3 bootloader (on PC10/PC11)	USART3	Enabled	Once initialized, the USART3 configuration is: 8 bits, even parity and 1 Stop bit.
	USART3_RX pin	Input	PC11 pin: USART3 in reception mode
	USART3_TX pin	Output	PC10 pin: USART3 in transmission mode
USARTx bootloaders	SysTick timer	Enabled	Used to automatically detect the serial baud rate from the host for USARTx bootloaders.
CAN2 bootloader	CAN2	Enabled	Once initialized, the CAN2 configuration is: Baudrate 125 kbps, 11-bit identifier. Note: CAN1 is clocked during CAN2 bootloader execution because CAN1 manages the communication between CAN2 and SRAM.
	CAN2_RX pin	Input	PB5 pin: CAN2 in reception mode
	CAN2_TX pin	Output	PB13 pin: CAN2 in transmission mode
DFU bootloader	USB	Enabled	USB OTG FS configured in forced device mode
	USB_DM pin	Input/Output	PA11: USB DM line.
	USB_DP pin		PA12: USB DP line No external Pull-up resistor is required
CAN2 and DFU bootloaders	TIM11	Enabled	This timer is used to determine the value of the HSE. Once the HSE frequency is determined, the system clock is configured to 60 MHz using PLL and HSE.

The system clock is derived from the embedded internal high-speed RC for USARTx bootloaders. This internal clock is also used for CAN and DFU (USB FS Device) but only for the selection phase. An external clock multiple of 1 MHz (between 4 and 26 MHz) is required for CAN and DFU bootloader execution after the selection phase.

26.1.2 Bootloader selection

The figure below shows the bootloader selection mechanism.

Figure 28. Bootloader V3.x selection for STM32F40xxx/41xxx devices

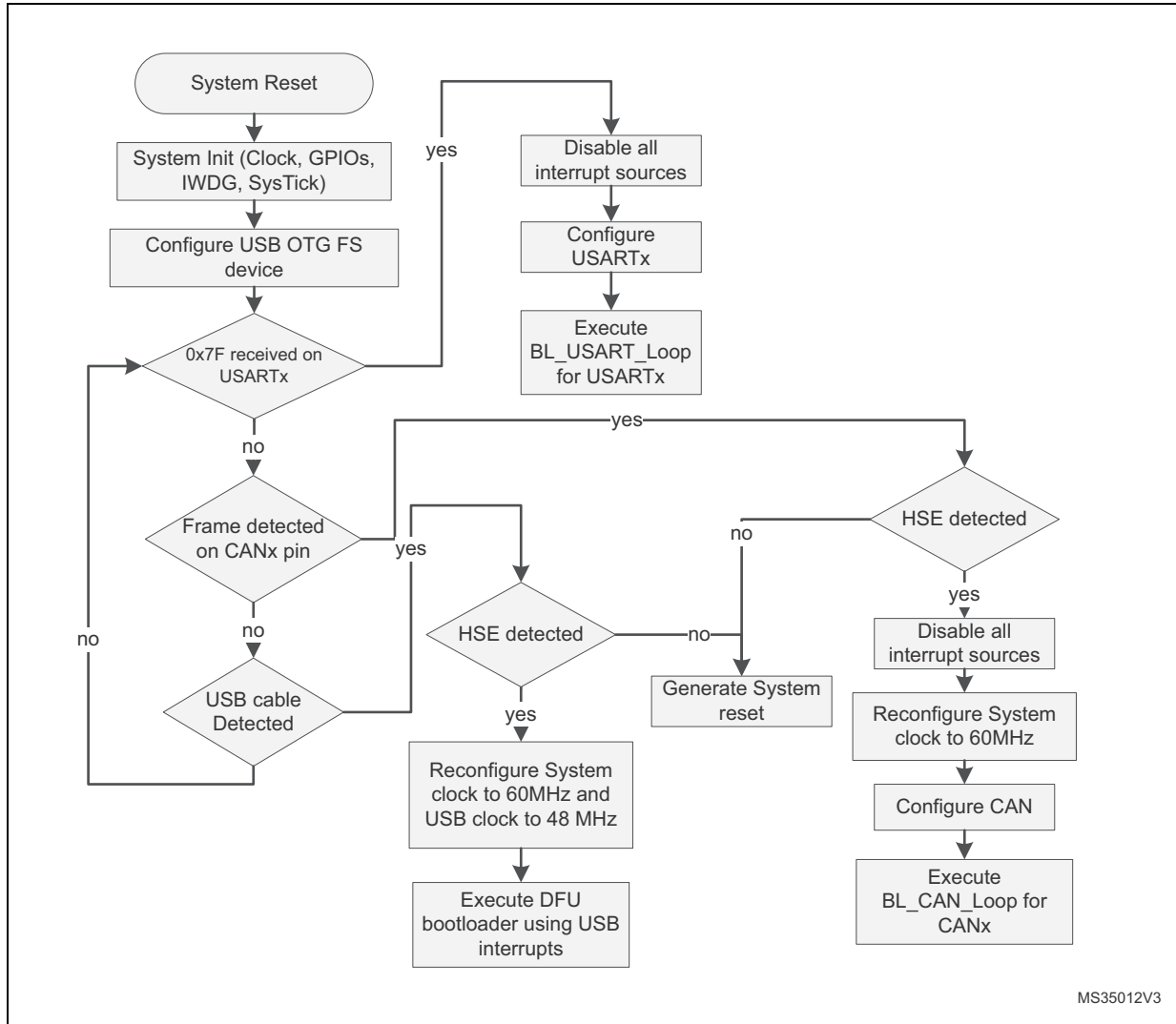

26.1.3 Bootloader version

The following table lists the STM32F40xxx/41xxx devices V3.x bootloader versions:

Table 51. STM32F40xxx/41xxx bootloader V3.x versions

Bootloader version number	Description	Known limitations
V3.0	Initial bootloader version	<ul style="list-style-type: none"> – When a Read Memory command or Write Memory command is issued with an unsupported memory address and a correct address checksum (ie. address 0x6000 0000), the command is aborted by the bootloader device, but the NACK (0x1F) is not sent to the host. As a result, the next 2 bytes (which are the number of bytes to be read/written and its checksum) are considered as a new command and its checksum⁽¹⁾. – Option bytes, OTP and Device Feature descriptors (in DFU interface) are set to “g” instead of “e” (not erasable memory areas). <p>After executing Go command (jump to user code) the bootloader resets AHB1ENR value to 0x0000 0000 and thus CCM RAM, when present, is not active (shall be re-enabled by user code at startup)</p>
V3.1	Fix V3.0 limitations. DFU interface robustness enhancement.	<ul style="list-style-type: none"> – For the USART interface, two consecutive NACKs (instead of 1 NACK) are sent when a Read Memory or Write Memory command is sent and the RDP level is active. – For the CAN interface, the Write Unprotect command is not functional. Instead you can use Write Memory command and write directly to the option bytes in order to disable the write protection. <p>After executing Go command (jump to user code) the bootloader resets AHB1ENR value to 0x0000 0000 and thus CCM RAM, when present, is not active (shall be re-enabled by user code at startup)</p>

1. If the “number of data - 1” (N-1) to be read/written is not equal to a valid command code (0x00, 0x01, 0x02, 0x11, 0x21, 0x31, 0x43, 0x44, 0x63, 0x73, 0x82 or 0x92), then the limitation is not perceived from the host since the command is NACKed anyway (as an unsupported new command).

26.2 Bootloader V9.x

26.2.1 Bootloader configuration

The STM32F40xxx/41xxx bootloader is activated by applying pattern1 (described in [Table 2: Bootloader activation patterns](#)). The following table shows the hardware resources used by this bootloader.

Note: The bootloader version V9.x is only embedded in STM32F405xx/415xx WCSP90 package devices.

Table 52. STM32F40xxx/41xxx configuration in system memory boot mode

Bootloader	Feature/Peripheral	State	Comment
Common to all bootloaders	RCC	HSI enabled	The system clock frequency is 60 MHz using the PLL. The HSI clock source is used at startup (interface detection phase) and when USART or SPI or I2C interfaces are selected (once CAN or DFU bootloader is selected, the clock source will be derived from the external crystal).
		HSE enabled	The system clock frequency is 60 MHz. The HSE clock source is used only when the CAN or the DFU (USB FS Device) interfaces are selected. The external clock must provide a frequency multiple of 1 MHz and ranging from 4 MHz to 26 MHz.
		-	The Clock Security System (CSS) interrupt is enabled for the CAN and DFU bootloaders. Any failure (or removal) of the external clock generates system reset.
	RAM	-	12 Kbyte starting from address 0x20000000 are used by the bootloader firmware
	System memory	-	29 Kbyte starting from address 0x1FFF0000, contain the bootloader firmware
	IWDG	-	The independent watchdog (IWDG) prescaler is configured to its maximum value. It is periodically refreshed to prevent watchdog reset (in case the hardware IWDG option was previously enabled by the user).
	Power	-	Voltage range is set to [1.62 V, 2.1 V]. In this range internal Flash write operations are allowed only in byte format (Half-Word, Word and Double-Word operations are not allowed). The voltage range can be configured in run time using bootloader commands.

Table 52. STM32F40xxx/41xxx configuration in system memory boot mode (continued)

Bootloader	Feature/Peripheral	State	Comment
USART1 bootloader	USART1	Enabled	Once initialized the USART1 configuration is: 8-bits, even parity and 1 Stop bit
	USART1_RX pin	Input	PA10 pin: USART1 in reception mode
	USART1_TX pin	Output	PA9 pin: USART1 in transmission mode
USART3 bootloader (on PB10/PB11)	USART3	Enabled	Once initialized the USART3 configuration is: 8-bits, even parity and 1 Stop bit
	USART3_RX pin	Input	PB11 pin: USART3 in reception mode
	USART3_TX pin	Output	PB10 pin: USART3 in transmission mode
USART3 bootloader (on PC10/PC11)	USART3	Enabled	Once initialized the USART3 configuration is: 8-bits, even parity and 1 Stop bit
	USART3_RX pin	Input	PC11 pin: USART3 in reception mode
	USART3_TX pin	Output	PC10 pin: USART3 in transmission mode
USARTx bootloaders	SysTick timer	Enabled	Used to automatically detect the serial baud rate from the host for USARTx bootloaders.
CAN2 bootloader	CAN2	Enabled	Once initialized the CAN2 configuration is: Baudrate 125 kbps, 11-bit identifier. Note: CAN1 is clocked during CAN2 bootloader execution because CAN1 manages the communication between CAN2 and SRAM.
	CAN2_RX pin	Input	PB5 pin: CAN2 in reception mode
	CAN2_TX pin	Output	PB13 pin: CAN2 in transmission mode
I2C1 bootloader	I2C1	Enabled	The I2C1 configuration is: I2C speed: up to 400 KHz, 7-bit address, slave mode, analog filter ON. Slave 7-bit address: 0b0111010x (where x = 0 for write and x = 1 for read).
	I2C1_SCL pin	Input/Output	PB6 pin: clock line is used in open-drain mode.
	I2C1_SDA pin	Input/Output	PB7 pin: data line is used in open-drain mode.
I2C2 bootloader	I2C2	Enabled	The I2C2 configuration is: I2C speed: up to 400 KHz, 7-bit address, slave mode, analog filter ON. Slave 7-bit address: 0b0111010x (where x = 0 for write and x = 1 for read).
	I2C2_SCL pin	Input/Output	PF1 pin: clock line is used in open-drain mode.
	I2C2_SDA pin	Input/Output	PF0 pin: data line is used in open-drain mode.

Table 52. STM32F40xxx/41xxx configuration in system memory boot mode (continued)

Bootloader	Feature/Peripheral	State	Comment
I2C3 bootloader	I2C3	Enabled	The I2C3 configuration is: I2C speed: up to 400 KHz, 7-bit address, slave mode, analog filter ON. Slave 7-bit address: 0b0111010x (where x = 0 for write and x = 1 for read).
	I2C3_SCL pin	Input/Output	PA8 pin: clock line is used in open-drain mode.
	I2C3_SDA pin	Input/Output	PC9 pin: data line is used in open-drain mode.
SPI1 bootloader	SPI1	Enabled	The SPI1 configuration is: slave mode, Full Duplex, 8-bit MSB, Speed up to 8 MHz, Polarity: CPOL Low, CPHA Low, NSS hardware.
	SPI1_MOSI pin	Input	PA7 pin: Slave data Input line, used in push-pull pull-down mode
	SPI1_MISO pin	Output	PA6 pin: Slave data output line, used in push-pull pull-down mode
	SPI1_SCK pin	Input	PA5 pin: Slave clock line, used in push-pull pull-down mode
	SPI1_NSS pin	Input	PA4 pin: slave chip select pin used in push-pull pull-down mode.
SPI2 bootloader	SPI2	Enabled	The SPI2 configuration is: Slave mode, Full Duplex, 8-bit MSB, Speed up to 8 MHz, Polarity: CPOL Low, CPHA Low, NSS hardware.
	SPI2_MOSI pin	Input	PI3 pin: Slave data Input line, used in push-pull pull-down mode
	SPI2_MISO pin	Output	PI2 pin: Slave data output line, used in push-pull pull-down mode
	SPI2_SCK pin	Input	PI1 pin: Slave clock line, used in push-pull pull-down mode
	SPI2_NSS pin	Input	PI0 pin: slave chip select pin used in push-pull pull-down mode.
DFU bootloader	USB	Enabled	USB OTG FS configured in forced device mode
	USB_DM pin	Input/Output	PA11: USB DM line.
	USB_DP pin		PA12: USB DP line No external Pull-up resistor is required
CAN2 and DFU bootloaders	TIM11	Enabled	This timer is used to determine the value of the HSE. Once the HSE frequency is determined, the system clock is configured to 60 MHz using PLL and HSE.

The system clock is derived from the embedded internal high-speed RC for USARTx, I2Cx and SPIx bootloaders. This internal clock is also used for CAN and DFU (USB FS Device) but only for the selection phase. An external clock multiple of 1 MHz (between 4 and 26 MHz) is required for CAN and DFU bootloader execution after the selection phase.

26.2.2 Bootloader selection

The figure below shows the bootloader selection mechanism.

Figure 29. Bootloader V9.x selection for STM32F40xxx/41xxx

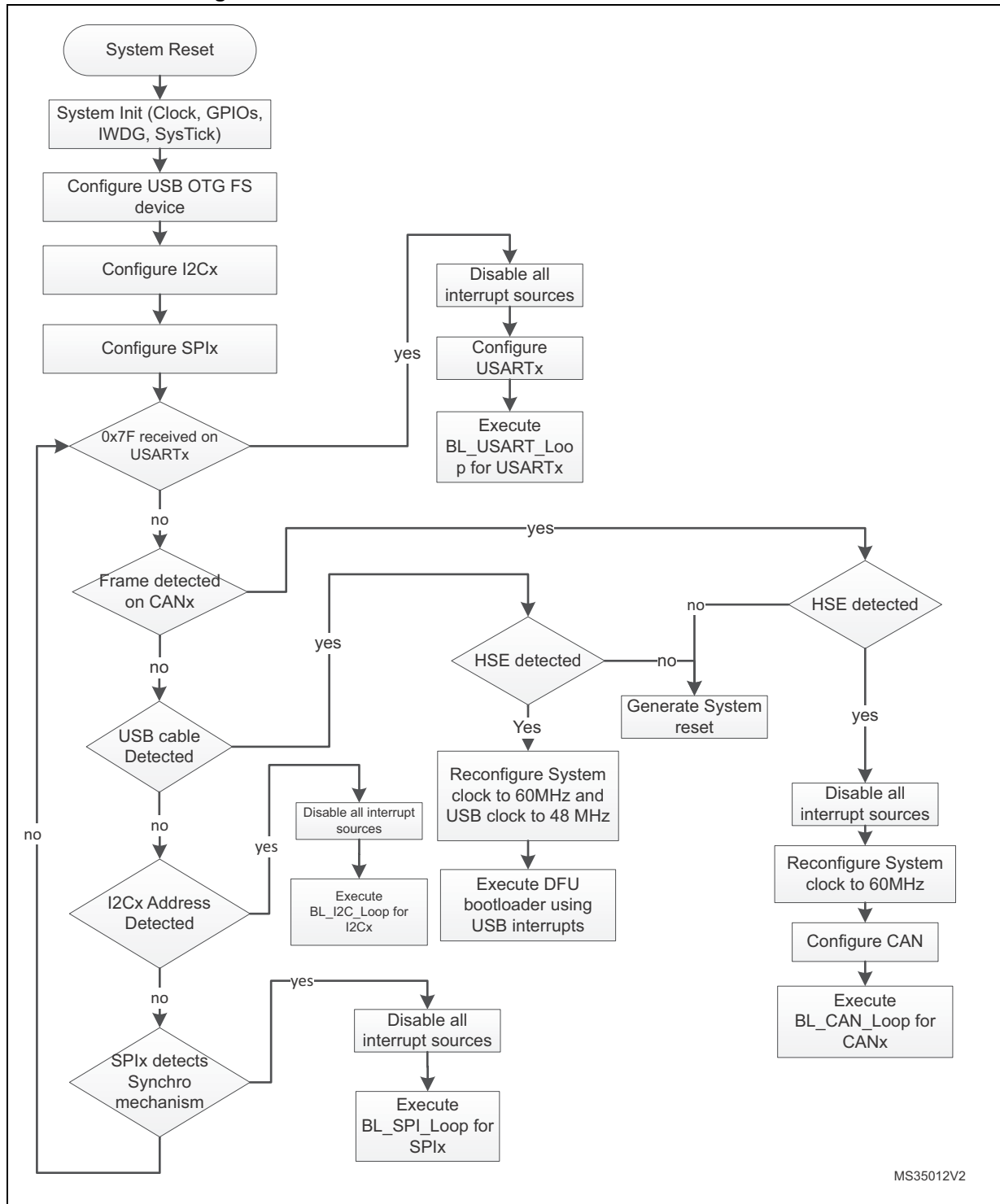

26.2.3 Bootloader version

The following table lists the STM32F40xxx/41xxx devices V9.x bootloader versions.

Table 53. STM32F40xxx/41xxx bootloader V9.x versions

Bootloader version number	Description	Known limitations
V9.0	<p>This bootloader is an updated version of bootloader v3.1.</p> <p>This new version of bootloader supports I2C1, I2C2, I2C3, SPI1 and SPI2 interfaces.</p> <p>The RAM used by this bootloader is increased from 8Kb to 12Kb.</p> <p>The ID of this bootloader is 0x90.</p> <p>The connection time is increased.</p>	<ul style="list-style-type: none"> – For the USART interface, two consecutive NACKs (instead of 1 NACK) are sent when a Read Memory or Write Memory command is sent and the RDP level is active. – For the CAN interface, the Write Unprotect command is not functional. Instead you can use Write Memory command and write directly to the option bytes in order to disable the write protection. <p>After executing Go command (jump to user code) the bootloader resets AHB1ENR value to 0x0000 0000 and thus CCM RAM, when present, is not active (shall be re-enabled by user code at startup)</p>

27 STM32F401xB(C) devices bootloader

27.1 Bootloader configuration

The STM32F401xB(C) bootloader is activated by applying pattern1 (described in [Table 2: Bootloader activation patterns](#)). The following table shows the hardware resources used by this bootloader.

Table 54. STM32F401xB(C) configuration in system memory boot mode

Bootloader	Feature/Peripheral	State	Comment
Common to all bootloaders	RCC	HSI enabled	The system clock frequency is 60 MHz using the PLL. The HSI clock source is used at startup (interface detection phase) and when USART or SPI or I2C interface is selected (once DFU bootloader is selected, the clock source will be derived from the external crystal).
		HSE enabled	The system clock frequency is 60 MHz. The HSE clock source is used only when the DFU (USB FS Device) interface is selected. The external clock must provide a frequency multiple of 1 MHz and ranging from 4 MHz to 26 MHz.
		-	The Clock Security System (CSS) interrupt is enabled for the CAN and DFU bootloaders. Any failure (or removal) of the external clock generates system reset.
	RAM	-	12 Kbyte starting from address 0x20000000 are used by the bootloader firmware
	System memory	-	29 Kbyte starting from address 0x1FFF0000, contain the bootloader firmware
	IWDG	-	The independent watchdog (IWDG) prescaler is configured to its maximum value. It is periodically refreshed to prevent watchdog reset (in case the hardware IWDG option was previously enabled by the user).
	Power	-	Voltage range is set to [1.62 V, 2.1 V]. In this range internal Flash write operations are allowed only in byte format (Half-Word, Word and Double-Word operations are not allowed). The voltage range can be configured in run time using bootloader commands.

Table 54. STM32F401xB(C) configuration in system memory boot mode (continued)

Bootloader	Feature/Peripheral	State	Comment
USART1 bootloader	USART1	Enabled	Once initialized the USART1 configuration is: 8-bits, even parity and 1 Stop bit
	USART1_RX pin	Input	PA10 pin: USART1 in reception mode
	USART1_TX pin	Output	PA9 pin: USART1 in transmission mode
USART2 bootloader	USART2	Enabled	Once initialized the USART2 configuration is: 8-bits, even parity and 1 Stop bit
	USART2_RX pin	Input	PD6 pin: USART2 in reception mode
	USART2_TX pin	Output	PD5 pin: USART2 in transmission mode
USARTx bootloaders	SysTick timer	Enabled	Used to automatically detect the serial baud rate from the host for USARTx bootloaders.
I2C1 bootloader	I2C1	Enabled	The I2C1 configuration is: I2C speed: up to 400 KHz, 7-bit address, slave mode, analog filter ON. Slave 7-bit address: 0b0111001x (where x = 0 for write and x = 1 for read)
	I2C1_SCL pin	Input/Output	PB6 pin: clock line is used in open-drain mode.
	I2C1_SDA pin	Input/Output	PB7 pin: data line is used in open-drain mode.
I2C2 bootloader	I2C2	Enabled	The I2C2 configuration is: I2C speed: up to 400 KHz, 7-bit address, slave mode, analog filter ON. Slave 7-bit address: 0b0111001x (where x = 0 for write and x = 1 for read)
	I2C2_SCL pin	Input/Output	PB10 pin: clock line is used in open-drain mode.
	I2C2_SDA pin	Input/Output	PB3 pin: data line is used in open-drain mode.
I2C3 bootloader	I2C3	Enabled	The I2C3 configuration is: I2C speed: up to 400 KHz, 7-bit address, slave mode, analog filter ON. Slave 7-bit address: 0b0111001x (where x = 0 for write and x = 1 for read)
	I2C3_SCL pin	Input/Output	PA8 pin: clock line is used in open-drain mode.
	I2C3_SDA pin	Input/Output	PB4 pin: data line is used in open-drain mode.

Table 54. STM32F401xB(C) configuration in system memory boot mode (continued)

Bootloader	Feature/Peripheral	State	Comment
SPI1 bootloader	SPI1	Enabled	The SPI1 configuration is: Slave mode, Full Duplex, 8-bit MSB, Speed up to 8 MHz, Polarity: CPOL Low, CPHA Low, NSS hardware.
	SPI1_MOSI pin	Input	PA7 pin: Slave data Input line, used in push-pull pull-down mode
	SPI1_MISO pin	Output	PA6 pin: Slave data output line, used in push-pull pull-down mode
	SPI1_SCK pin	Input	PA5 pin: Slave clock line, used in push-pull pull-down mode
	SPI1_NSS pin	Input	PA4 pin: slave chip select pin used in push-pull pull-down mode.
SPI2 bootloader	SPI2	Enabled	The SPI2 configuration is: Slave mode, Full Duplex, 8-bit MSB, Speed up to 8 MHz, Polarity: CPOL Low, CPHA Low, NSS hardware.
	SPI2_MOSI pin	Input	PB15 pin: Slave data Input line, used in push-pull pull-down mode
	SPI2_MISO pin	Output	PB14 pin: Slave data output line, used in push-pull pull-down mode
	SPI2_SCK pin	Input	PB13 pin: Slave clock line, used in push-pull pull-down mode
	SPI2_NSS pin	Input	PB12 pin: slave chip select pin used in push-pull pull-down mode.
SPI3 bootloader	SPI3	Enabled	The SPI3 configuration is: Slave mode, Full Duplex, 8-bit MSB, Speed up to 8 MHz, Polarity: CPOL Low, CPHA Low, NSS hardware.
	SPI3_MOSI pin	Input	PC12 pin: Slave data Input line, used in push-pull pull-down mode
	SPI3_MISO pin	Output	PC11 pin: Slave data output line, used in push-pull pull-down mode
	SPI3_SCK pin	Input	PC10 pin: Slave clock line, used in push-pull pull-down mode
	SPI3_NSS pin	Input	PA15 pin: slave chip select pin used in push-pull pull-down mode.

Table 54. STM32F401xB(C) configuration in system memory boot mode (continued)

Bootloader	Feature/Peripheral	State	Comment
DFU bootloader	USB	Enabled	USB OTG FS configured in forced device mode
	USB_DM pin	Input/Output	PA11: USB DM line.
	USB_DP pin		PA12: USB DP line No external Pull-up resistor is required
	TIM11	Enabled	This timer is used to determine the value of the HSE. Once the HSE frequency is determined, the system clock is configured to 60 MHz using PLL and HSE.

The system clock is derived from the embedded internal high-speed RC for USARTx, I2Cx and SPIx bootloaders. This internal clock is also used for CAN and DFU (USB FS Device) but only for the selection phase. An external clock multiple of 1 MHz (between 4 and 26 MHz) is required for CAN and DFU bootloader execution after the selection phase.

27.2 Bootloader selection

The figure below shows the bootloader selection mechanism.

Figure 30. Bootloader selection for STM32F401xB(C)

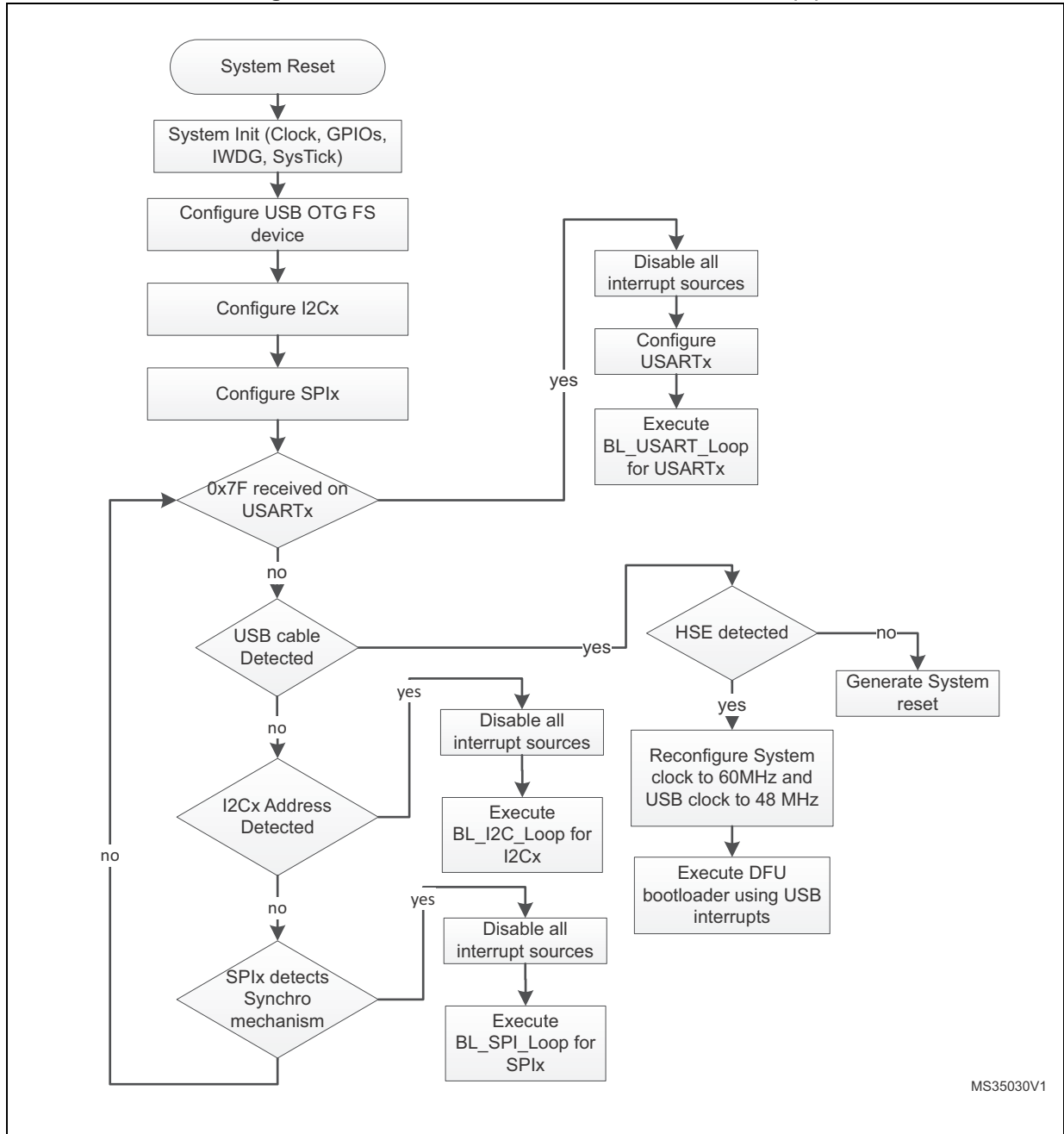

27.3 Bootloader version

The following table lists the STM32F401xB(C) devices bootloader version.

Table 55. STM32F401xB(C) bootloader versions

Bootloader version number	Description	Known limitations
V13.0	Initial bootloader version	After executing Go command (jump to user code) the bootloader resets AHB1ENR value to 0x0000 0000 and thus CCM RAM, when present, is not active (shall be re-enabled by user code at startup)

28 STM32F401xD(E) devices bootloader

28.1 Bootloader configuration

The STM32F401xD(E) bootloader is activated by applying pattern1 (described in [Table 2: Bootloader activation patterns](#)). The following table shows the hardware resources used by this bootloader.

Table 56. STM32F401xD(E) configuration in system memory boot mode

Bootloader	Feature/Peripheral	State	Comment
Common to all bootloaders	RCC	HSI enabled	The system clock frequency is 60 MHz using the PLL. The HSI clock source is used at startup (interface detection phase) and when USART or SPI or I2C interface is selected (once DFU bootloader is selected, the clock source will be derived from the external crystal).
		HSE enabled	The system clock frequency is 60 MHz. The HSE clock source is used only when the DFU (USB FS Device) interface is selected. The external clock must provide a frequency multiple of 1 MHz and ranging from 4 MHz to 26 MHz.
		-	The Clock Security System (CSS) interrupt is enabled for the DFU bootloader. Any failure (or removal) of the external clock generates system reset.
	RAM	-	12 Kbyte starting from address 0x20000000 are used by the bootloader firmware
	System memory	-	29 Kbyte starting from address 0x1FFF0000, contain the bootloader firmware
	IWDG	-	The independent watchdog (IWDG) prescaler is configured to its maximum value. It is periodically refreshed to prevent watchdog reset (in case the hardware IWDG option was previously enabled by the user).
	Power	-	Voltage range is set to [1.62 V, 2.1 V]. In this range internal Flash write operations are allowed only in byte format (Half-Word, Word and Double-Word operations are not allowed). The voltage range can be configured in run time using bootloader commands.

Table 56. STM32F401xD(E) configuration in system memory boot mode (continued)

Bootloader	Feature/Peripheral	State	Comment
USART1 bootloader	USART1	Enabled	Once initialized the USART1 configuration is: 8-bits, even parity and 1 Stop bit
	USART1_RX pin	Input	PA10 pin: USART1 in reception mode
	USART1_TX pin	Output	PA9 pin: USART1 in transmission mode
USART2 bootloader	USART2	Enabled	Once initialized the USART2 configuration is: 8-bits, even parity and 1 Stop bit
	USART2_RX pin	Input	PD6 pin: USART2 in reception mode
	USART2_TX pin	Output	PD5 pin: USART2 in transmission mode
USARTx bootloaders	SysTick timer	Enabled	Used to automatically detect the serial baud rate from the host for USARTx bootloaders.
I2C1 bootloader	I2C1	Enabled	The I2C1 configuration is: I2C speed: up to 400 KHz, 7-bit address, slave mode, analog filter ON. Slave 7-bit address: 0b0111001x (where x = 0 for write and x = 1 for read)
	I2C1_SCL pin	Input/Output	PB6 pin: clock line is used in open-drain mode.
	I2C1_SDA pin	Input/Output	PB7 pin: data line is used in open-drain mode.
I2C2 bootloader	I2C2	Enabled	The I2C2 configuration is: I2C speed: up to 400 KHz, 7-bit address, slave mode, analog filter ON. Slave 7-bit address: 0b0111001x (where x = 0 for write and x = 1 for read)
	I2C2_SCL pin	Input/Output	PB10 pin: clock line is used in open-drain mode.
	I2C2_SDA pin	Input/Output	PB3 pin: data line is used in open-drain mode.
I2C3 bootloader	I2C3	Enabled	The I2C3 configuration is: I2C speed: up to 400 KHz, 7-bit address, slave mode, analog filter ON. Slave 7-bit address: 0b0111001x (where x = 0 for write and x = 1 for read)
	I2C3_SCL pin	Input/Output	PA8 pin: clock line is used in open-drain mode.
	I2C3_SDA pin	Input/Output	PB4 pin: data line is used in open-drain mode.

Table 56. STM32F401xD(E) configuration in system memory boot mode (continued)

Bootloader	Feature/Peripheral	State	Comment
SPI1 bootloader	SPI1	Enabled	The SPI1 configuration is: Slave mode, Full Duplex, 8-bit MSB, Speed up to 8 MHz, Polarity: CPOL Low, CPHA Low, NSS hardware.
	SPI1_MOSI pin	Input	PA7 pin: Slave data Input line, used in push-pull pull-down mode
	SPI1_MISO pin	Output	PA6 pin: Slave data output line, used in push-pull pull-down mode
	SPI1_SCK pin	Input	PA5 pin: Slave clock line, used in push-pull pull-down mode
	SPI1_NSS pin	Input	PA4 pin: slave chip select pin used in push-pull pull-down mode.
SPI2 bootloader	SPI2	Enabled	The SPI2 configuration is: Slave mode, Full Duplex, 8-bit MSB, Speed up to 8 MHz, Polarity: CPOL Low, CPHA Low, NSS hardware.
	SPI2_MOSI pin	Input	PB15 pin: Slave data Input line, used in push-pull pull-down mode
	SPI2_MISO pin	Output	PB14 pin: Slave data output line, used in push-pull pull-down mode
	SPI2_SCK pin	Input	PB13 pin: Slave clock line, used in push-pull pull-down mode
	SPI2_NSS pin	Input	PB12 pin: slave chip select pin used in push-pull pull-down mode.
SPI3 bootloader	SPI3	Enabled	The SPI3 configuration is: Slave mode, Full Duplex, 8-bit MSB, Speed up to 8 MHz, Polarity: CPOL Low, CPHA Low, NSS hardware.
	SPI3_MOSI pin	Input	PC12 pin: Slave data Input line, used in push-pull pull-down mode
	SPI3_MISO pin	Output	PC11 pin: Slave data output line, used in push-pull pull-down mode
	SPI3_SCK pin	Input	PC10 pin: Slave clock line, used in push-pull pull-down mode
	SPI3_NSS pin	Input	PA15 pin: slave chip select pin used in push-pull pull-down mode.
DFU bootloader	USB	Enabled	USB OTG FS configured in forced device mode
	USB_DM pin	Input/Output	PA11: USB DM line.
	USB_DP pin		PA12: USB DP line No external Pull-up resistor is required
	TIM11	Enabled	This timer is used to determine the value of the HSE. Once the HSE frequency is determined, the system clock is configured to 60 MHz using PLL and HSE.

The system clock is derived from the embedded internal high-speed RC for USARTx, I2Cx and SPIx bootloaders. This internal clock is also used for DFU (USB FS Device) but only for the selection phase. An external clock multiple of 1 MHz (between 4 and 26 MHz) is required for DFU bootloader execution after the selection phase.

28.2 Bootloader selection

The figure below shows the bootloader selection mechanism.

Figure 31. Bootloader selection for STM32F401xD(E)

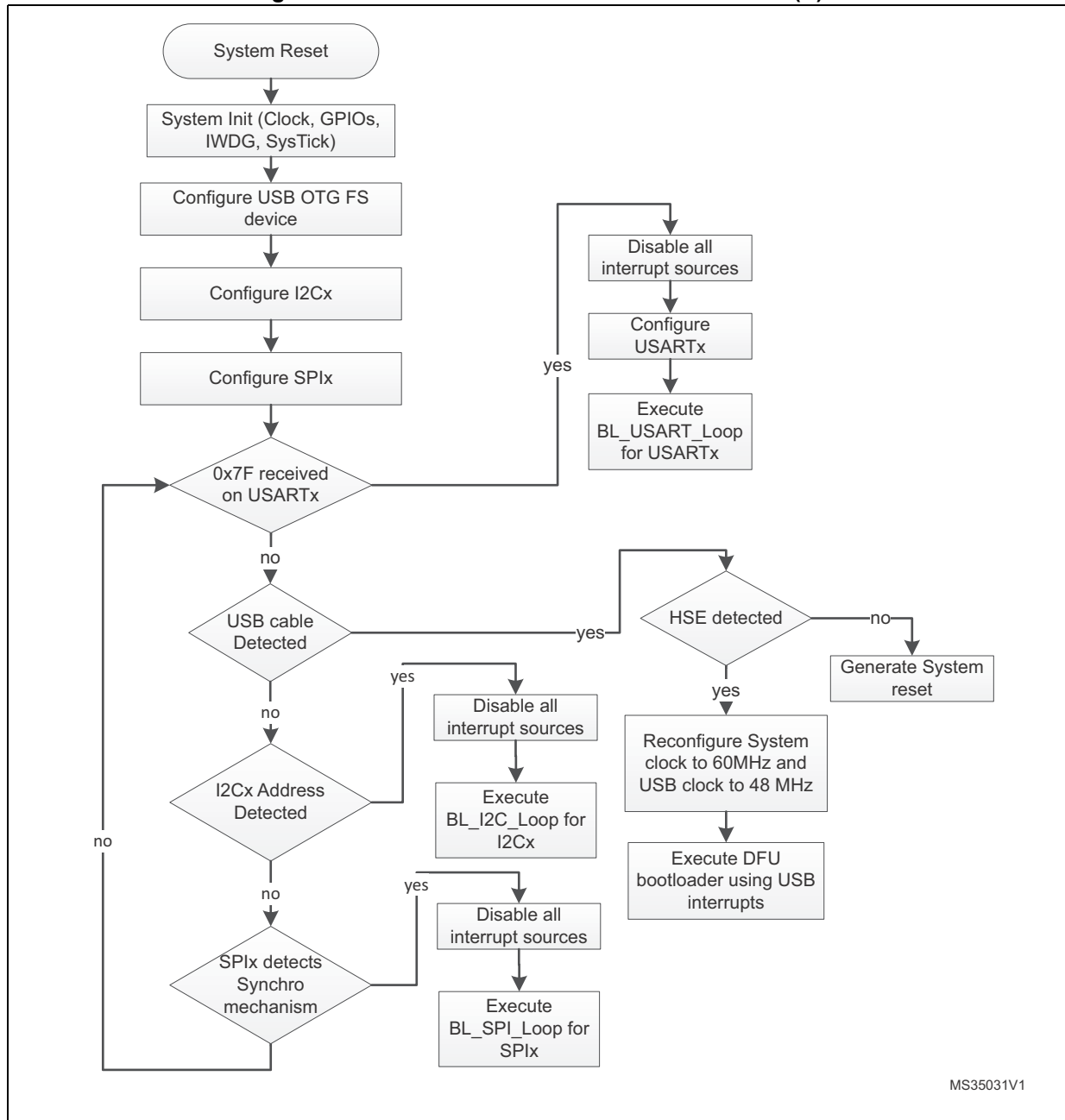

MS35031V1

28.3 Bootloader version

The following table lists the STM32F401xD(E) devices bootloader version.

Table 57. STM32F401xD(E) bootloader versions

Bootloader version number	Description	Known limitations
V13.1	Initial bootloader version	After executing Go command (jump to user code) the bootloader resets AHB1ENR value to 0x0000 0000 and thus CCM RAM, when present, is not active (shall be re-enabled by user code at startup)

29 STM32F410xx devices bootloader

29.1 Bootloader configuration

The STM32F410xx bootloader is activated by applying pattern1 (described in [Table 2: Bootloader activation patterns](#)). The following table shows the hardware resources used by this bootloader.

Table 58. STM32F410xx configuration in system memory boot mode

Bootloader	Feature/Peripheral	State	Comment
Common to all bootloaders	RCC	HSI enabled	The HSI is used at startup as clock source for system clock configured to 60 MHz and for USART and I2C bootloader operation.
	RAM	-	5 Kbyte starting from address 0x20000000 are used by the bootloader firmware
	System memory	-	29 Kbyte starting from address 0x1FFF0000, contain the bootloader firmware
	IWDG	-	The independent watchdog (IWDG) prescaler is configured to its maximum value. It is periodically refreshed to prevent watchdog reset (in case the hardware IWDG option was previously enabled by the user).
	Power	-	The voltage range is [1.8V, 3.6V] In this range: - Flash wait states 3. - System clock Frequency 60 MHz. - ART Accelerator enabled. - Flash write operation by byte (refer to bootloader memory management section for more information).
USART1 bootloader	USART1	Enabled	Once initialized the USART1 configuration is: 8-bits, even parity and 1 Stop bit
	USART1_RX pin	Input	PA10 pin: USART1 in reception mode
	USART1_TX pin	Output	PA9 pin: USART1 in transmission mode
USART2 bootloader	USART2	Enabled	Once initialized the USART2 configuration is: 8-bits, even parity and 1 Stop bit
	USART2_RX pin	Input	PA3 pin: USART2 in reception mode
	USART2_TX pin	Output	PA2 pin: USART2 in transmission mode
USARTx bootloaders	SysTick timer	Enabled	Used to automatically detect the serial baud rate from the host for USARTx bootloaders.

Table 58. STM32F410xx configuration in system memory boot mode (continued)

Bootloader	Feature/Peripheral	State	Comment
I2C1 bootloader	I2C1	Enabled	The I2C1 configuration is: I2C speed: up to 400 KHz, 7-bit address, slave mode, analog filter ON. Slave 7-bit address: 0b1000111x (where x = 0 for write and x = 1 for read)
	I2C1_SCL pin	Input/Output	PB6 pin: clock line is used in open-drain mode.
	I2C1_SDA pin	Input/Output	PB7 pin: data line is used in open-drain mode.
I2C2 bootloader	I2C2	Enabled	The I2C2 configuration is: I2C speed: up to 400 KHz, 7-bit address, slave mode, analog filter ON. Slave 7-bit address: 0b1000111x (where x = 0 for write and x = 1 for read)
	I2C2_SCL pin	Input/Output	PB10 pin: clock line is used in open-drain mode.
	I2C2_SDA pin	Input/Output	PB11 pin: data line is used in open-drain mode.
I2C4 bootloader	I2C4	Enabled	The I2C4 configuration is: I2C speed: up to 1 MHz, 7-bit address, slave mode, analog filter ON. Slave 7-bit address: 0b1000111x (where x = 0 for write and x = 1 for read)
	I2C4_SCL pin	Input/Output	PB15 pin: clock line is used in open-drain mode for STM32F410Cx/Rx devices. PB10 pin: clock line is used in open-drain mode for STM32F410Tx devices.
	I2C4_SDA pin	Input/Output	PB14 pin: data line is used in open-drain mode for STM32F410Cx/Rx devices. PB3 pin: data line is used in open-drain mode for STM32F410Tx devices.

Table 58. STM32F410xx configuration in system memory boot mode (continued)

Bootloader	Feature/Peripheral	State	Comment
SPI1 bootloader	SPI1	Enabled	The SPI1 configuration is: Slave mode, Full Duplex, 8-bit MSB, Speed up to 8MHz, Polarity: CPOL Low, CPHA Low, NSS hardware.
	SPI1_MOSI pin	Input	PA7 pin: Slave data Input line, used in push-pull pull-down mode for STM32F410Cx/Rx devices. PB5 pin: Slave data Input line, used in push-pull pull-down mode for STM32F410Tx devices.
	SPI1_MISO pin	Output	PA6 pin: Slave data output line, used in push-pull pull-down mode for STM32F410Cx/Rx devices. PB4 pin: Slave data output line, used in push-pull pull-down mode for STM32F410Tx devices.
	SPI1_SCK pin	Input	PA5 pin: Slave clock line, used in push- pull pull-down mode.
	SPI1_NSS pin	Input	PA4 pin: slave chip select pin used in push-pull pull-up mode for STM32F410Cx/Rx devices. PA15 pin: slave chip select pin used in push-pull pull-up mode for STM32F410Tx devices.
SPI2 bootloader	SPI2	Enabled	The SPI2 configuration is: Slave mode, Full Duplex, 8-bit MSB, Speed up to 8MHz, Polarity: CPOL Low, CPHA Low, NSS hardware.
	SPI2_MOSI pin	Input	PC3 pin: Slave data Input line, used in push-pull pull-down mode
	SPI2_MISO pin	Output	PC2 pin: Slave data output line, used in push-pull pull-down mode
	SPI2_SCK pin	Input	PB13 pin: Slave clock line, used in push- pull pull-down mode
	SPI2_NSS pin	Input	PB12 pin: slave chip select pin used in push-pull pull-up mode.

The system clock is derived from the embedded internal high-speed RC for all bootloader interfaces. No external quartz is required for bootloader operations.

29.2 Bootloader selection

The [Figure 32](#) shows the bootloader selection mechanism.

Figure 32.Bootloader V11.x selection for STM32F410xx

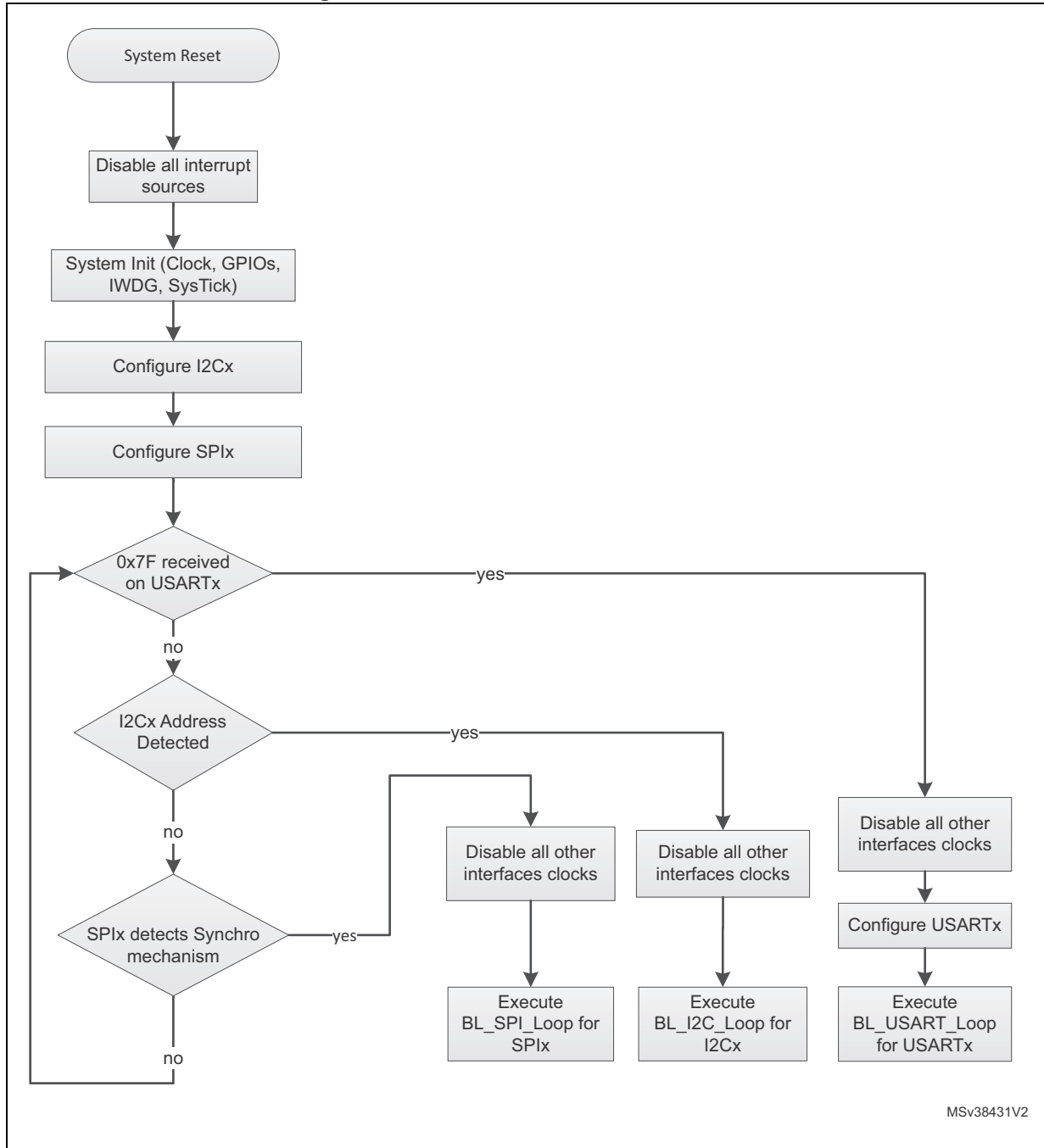

29.3 Bootloader version

The following table lists the STM32F410xx devices bootloader V11.x versions.

Table 59. STM32F410xx bootloader V11.x versions

Bootloader version number	Description	Known limitations
V11.0	Initial bootloader version	After executing Go command (jump to user code) the bootloader resets AHB1ENR value to 0x0000 0000 and thus CCM RAM, when present, is not active (shall be re-enabled by user code at startup)
V11.1	Support I2C4 and SPI1 for STM32F410Tx devices.	After executing Go command (jump to user code) the bootloader resets AHB1ENR value to 0x0000 0000 and thus CCM RAM, when present, is not active (shall be re-enabled by user code at startup)

30 STM32F411xx devices bootloader

30.1 Bootloader configuration

The STM32F411xx bootloader is activated by applying pattern1 (described in [Table 2: Bootloader activation patterns](#)). The following table shows the hardware resources used by this bootloader.

Table 60. STM32F411xx configuration in system memory boot mode

Bootloader	Feature/Peripheral	State	Comment
Common to all bootloaders	RCC	HSI enabled	The system clock frequency is 60 MHz using the PLL. The HSI clock source is used at startup (interface detection phase) and when USART or SPI or I2C interface is selected (once DFU bootloader is selected, the clock source will be derived from the external crystal).
		HSE enabled	The system clock frequency is 60 MHz. The HSE clock source is used only when the DFU (USB FS Device) interface is selected. The external clock must provide a frequency multiple of 1 MHz and ranging from 4 MHz to 26 MHz.
		-	The Clock Security System (CSS) interrupt is enabled for the DFU bootloader. Any failure (or removal) of the external clock generates system reset.
	RAM	-	12 Kbyte starting from address 0x20000000 are used by the bootloader firmware
	System memory	-	29 Kbyte starting from address 0x1FFF0000, contain the bootloader firmware
	IWDG	-	The independent watchdog (IWDG) prescaler is configured to its maximum value. It is periodically refreshed to prevent watchdog reset (in case the hardware IWDG option was previously enabled by the user).
	Power	-	Voltage range is set to [1.62 V, 2.1 V]. In this range internal Flash write operations are allowed only in byte format (Half-Word, Word and Double-Word operations are not allowed). The voltage range can be configured in run time using bootloader commands.

Table 60. STM32F411xx configuration in system memory boot mode (continued)

Bootloader	Feature/Peripheral	State	Comment
USART1 bootloader	USART1	Enabled	Once initialized the USART1 configuration is: 8-bits, even parity and 1 Stop bit
	USART1_RX pin	Input	PA10 pin: USART1 in reception mode
	USART1_TX pin	Output	PA9 pin: USART1 in transmission mode
USART2 bootloader	USART2	Enabled	Once initialized the USART2 configuration is: 8-bits, even parity and 1 Stop bit
	USART2_RX pin	Input	PD6 pin: USART2 in reception mode
	USART2_TX pin	Output	PD5 pin: USART2 in transmission mode
USARTx bootloaders	SysTick timer	Enabled	Used to automatically detect the serial baud rate from the host for USARTx bootloaders.
I2C1 bootloader	I2C1	Enabled	The I2C1 configuration is: I2C speed: up to 400 KHz, 7-bit address, slave mode, analog filter ON. Slave 7-bit address: 0b0111001x (where x = 0 for write and x = 1 for read)
	I2C1_SCL pin	Input/Output	PB6 pin: clock line is used in open-drain mode.
	I2C1_SDA pin	Input/Output	PB7 pin: data line is used in open-drain mode.
I2C2 bootloader	I2C2	Enabled	The I2C2 configuration is: I2C speed: up to 400 KHz, 7-bit address, slave mode, analog filter ON. Slave 7-bit address: 0b0111001x (where x = 0 for write and x = 1 for read)
	I2C2_SCL pin	Input/Output	PB10 pin: clock line is used in open-drain mode.
	I2C2_SDA pin	Input/Output	PB3 pin: data line is used in open-drain mode.
I2C3 bootloader	I2C3	Enabled	The I2C3 configuration is: I2C speed: up to 400 KHz, 7-bit address, slave mode, analog filter ON. Slave 7-bit address: 0b0111001x (where x = 0 for write and x = 1 for read)
	I2C3_SCL pin	Input/Output	PA8 pin: clock line is used in open-drain mode.
	I2C3_SDA pin	Input/Output	PB4 pin: data line is used in open-drain mode.

Table 60. STM32F411xx configuration in system memory boot mode (continued)

Bootloader	Feature/Peripheral	State	Comment
SPI1 bootloader	SPI1	Enabled	The SPI1 configuration is: Slave mode, Full Duplex, 8-bit MSB, Speed up to 8 MHz, Polarity: CPOL Low, CPHA Low, NSS hardware.
	SPI1_MOSI pin	Input	PA7 pin: Slave data Input line, used in push-pull pull-down mode
	SPI1_MISO pin	Output	PA6 pin: Slave data output line, used in push-pull pull-down mode
	SPI1_SCK pin	Input	PA5 pin: Slave clock line, used in push-pull pull-down mode
	SPI1_NSS pin	Input	PA4 pin: slave chip select pin used in push-pull pull-down mode.
SPI2 bootloader	SPI2	Enabled	The SPI2 configuration is: Slave mode, Full Duplex, 8-bit MSB, Speed up to 8 MHz, Polarity: CPOL Low, CPHA Low, NSS hardware.
	SPI2_MOSI pin	Input	PB15 pin: Slave data Input line, used in push-pull pull-down mode
	SPI2_MISO pin	Output	PB14 pin: Slave data output line, used in push-pull pull-down mode
	SPI2_SCK pin	Input	PB13 pin: Slave clock line, used in push-pull pull-down mode
	SPI2_NSS pin	Input	PB12 pin: slave chip select pin used in push-pull pull-down mode.
SPI3 bootloader	SPI3	Enabled	The SPI3 configuration is: Slave mode, Full Duplex, 8-bit MSB, Speed up to 8 MHz, Polarity: CPOL Low, CPHA Low, NSS hardware.
	SPI3_MOSI pin	Input	PC12 pin: Slave data Input line, used in push-pull pull-down mode
	SPI3_MISO pin	Output	PC11 pin: Slave data output line, used in push-pull pull-down mode
	SPI3_SCK pin	Input	PC10 pin: Slave clock line, used in push-pull pull-down mode
	SPI3_NSS pin	Input	PA15 pin: slave chip select pin used in push-pull pull-down mode.

Table 60. STM32F411xx configuration in system memory boot mode (continued)

Bootloader	Feature/Peripheral	State	Comment
DFU bootloader	USB	Enabled	USB OTG FS configured in forced device mode
	USB_DM pin	Input/Output	PA11: USB DM line.
	USB_DP pin		PA12: USB DP line No external Pull-up resistor is required
	TIM11	Enabled	This timer is used to determine the value of the HSE. Once the HSE frequency is determined, the system clock is configured to 60 MHz using PLL and HSE.

The system clock is derived from the embedded internal high-speed RC for USARTx, I2Cx and SPIx bootloaders. This internal clock is also used for DFU (USB FS Device) but only for the selection phase. An external clock multiple of 1 MHz (between 4 and 26 MHz) is required for DFU bootloader execution after the selection phase.

30.2 Bootloader selection

The figure below shows the bootloader selection mechanism.

Figure 33. Bootloader selection for STM32F411xx

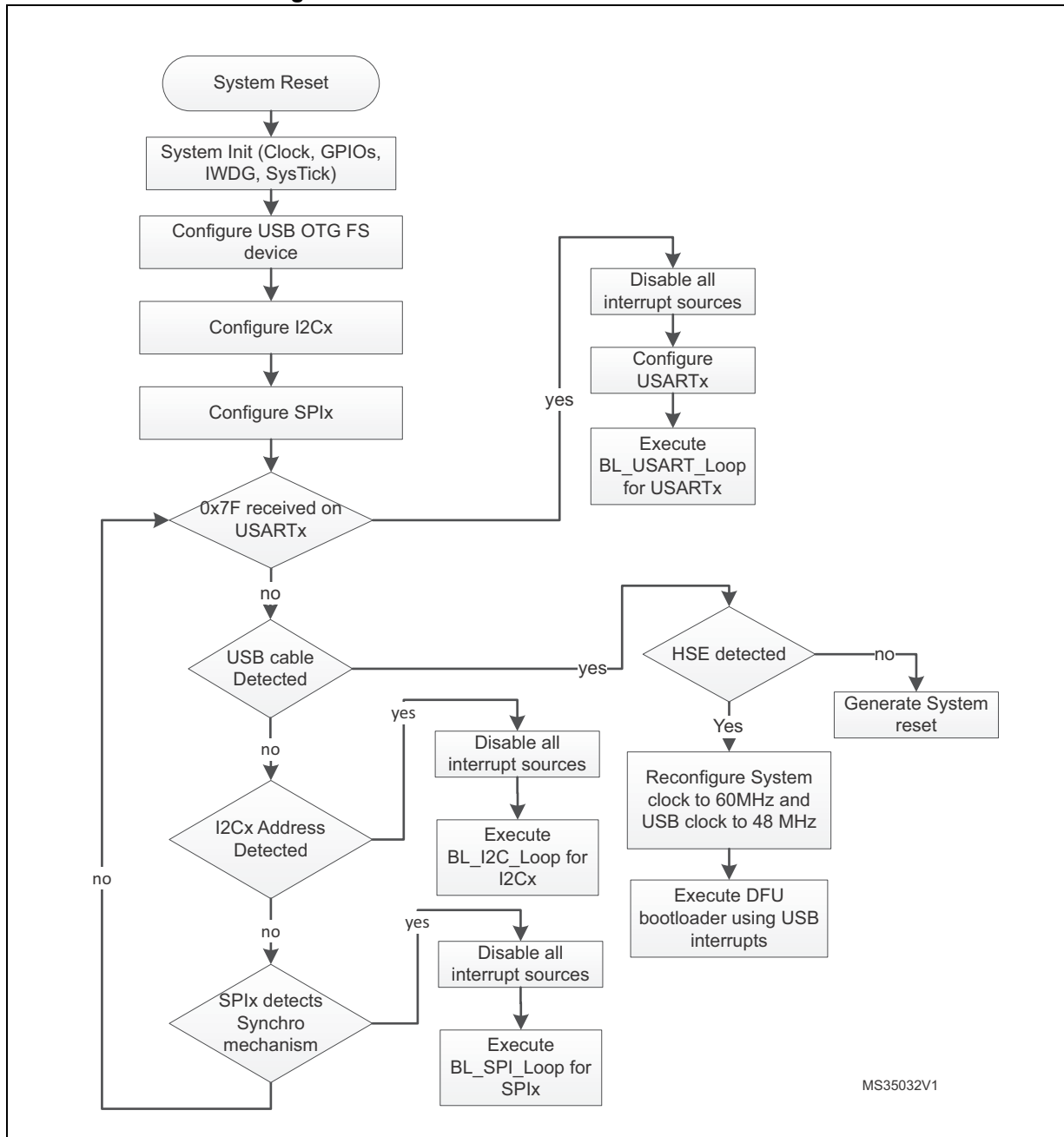

30.3 Bootloader version

The following table lists the STM32F411xx devices bootloader version.

Table 61. STM32F411xx bootloader versions

Bootloader version number	Description	Known limitations
V13.0	Initial bootloader version	After executing Go command (jump to user code) the bootloader resets AHB1ENR value to 0x0000 0000 and thus CCM RAM, when present, is not active (shall be re-enabled by user code at startup)

31 STM32F412xx devices bootloader

31.1 Bootloader configuration

The STM32F412xx bootloader is activated by applying pattern1 (described in [Table 2: Bootloader activation patterns](#)). The table shows the hardware resources used by this bootloader.

Table 62. STM32F412xx configuration in system memory boot mode

Bootloader	Feature/Peripheral	State	Comment
Common to all bootloaders	RCC	HSI enabled	The HSI is used at startup as clock source for system clock configured to 60 MHz and for USART and I2C bootloader operation.
		HSE enabled	The HSE is used only when the CAN or the DFU (USB FS Device) interfaces are selected. In this case the system clock configured to 60 MHz with HSE as clock source. The HSE frequency must be multiple of 1 MHz and ranging from 4 MHz to 26 MHz.
		-	The Clock Security System (CSS) interrupt is enabled for the CAN and DFU bootloaders. Any failure (or removal) of the external clock generates system reset.
	RAM	-	16 Kbyte starting from address 0x20000000 are used by the bootloader firmware
	System memory	-	29 Kbyte starting from address 0x1FFF0000, contain the bootloader firmware
	IWDG	-	The independent watchdog (IWDG) prescaler is configured to its maximum value. It is periodically refreshed to prevent watchdog reset (in case the hardware IWDG option was previously enabled by the user).
	Power	-	The voltage range is [1.8V, 3.6V] In this range: - Flash wait states 3. - System clock Frequency 60 MHz. - ART Accelerator enabled. - Flash write operation by byte (refer to bootloader memory management section for more information).

Table 62. STM32F412xx configuration in system memory boot mode (continued)

Bootloader	Feature/Peripheral	State	Comment
USART1 bootloader	USART1	Enabled	Once initialized the USART1 configuration is: 8-bits, even parity and 1 Stop bit
	USART1_RX pin	Input	PA10 pin: USART1 in reception mode
	USART1_TX pin	Output	PA9 pin: USART1 in transmission mode
USART2 bootloader	USART2	Enabled	Once initialized the USART2 configuration is: 8-bits, even parity and 1 Stop bit
	USART2_RX pin	Input	PD6 pin: USART2 in reception mode
	USART2_TX pin	Output	PD5 pin: USART2 in transmission mode
USART3 bootloader	USART3	Enabled	Once initialized the USART3 configuration is: 8-bits, even parity and 1 Stop bit
	USART3_RX pin	Input	PB11 pin: USART3 in reception mode
	USART3_TX pin	Output	PB10 pin: USART3 in transmission mode
USARTx bootloaders	SysTick timer	Enabled	Used to automatically detect the serial baud rate from the host for USARTx bootloaders.
CAN2 bootloader	CAN2	Enabled	Once initialized the CAN2 configuration is: Baudrate 125 kbps, 11-bit identifier. Note: CAN1 is clocked during CAN2 bootloader execution because CAN1 manages the communication between CAN2 and SRAM.
	CAN2_RX pin	Input	PB5 pin: CAN2 in reception mode
	CAN2_TX pin	Output	PB13 pin: CAN2 in transmission mode
I2C1 bootloader	I2C1	Enabled	The I2C1 configuration is: I2C speed: up to 400 KHz, 7-bit address, slave mode, analog filter ON. Slave 7-bit address: 0b1000110x (where x = 0 for write and x = 1 for read)
	I2C1_SCL pin	Input/Output	PB6 pin: clock line is used in open-drain mode.
	I2C1_SDA pin	Input/Output	PB7 pin: data line is used in open-drain mode.
I2C2 bootloader	I2C2	Enabled	The I2C2 configuration is: I2C speed: up to 400 KHz, 7-bit address, slave mode, analog filter ON. Slave 7-bit address: 0b1000110x (where x = 0 for write and x = 1 for read)
	I2C2_SCL pin	Input/Output	PF1 pin: clock line is used in open-drain mode.
	I2C2_SDA pin	Input/Output	PF0 pin: data line is used in open-drain mode.

Table 62. STM32F412xx configuration in system memory boot mode (continued)

Bootloader	Feature/Peripheral	State	Comment
I2C3 bootloader	I2C3	Enabled	The I2C3 configuration is: I2C speed: up to 400 KHz, 7-bit address, slave mode, analog filter ON. Slave 7-bit address: 0b1000110x (where x = 0 for write and x = 1 for read)
	I2C3_SCL pin	Input/Output	PA8 pin: clock line is used in open-drain mode.
	I2C3_SDA pin	Input/Output	PB4 pin: data line is used in open-drain mode.
I2C4 bootloader	I2C4	Enabled	The I2C4 configuration is: I2C speed: up to 1 MHz, 7-bit address, slave mode, analog filter ON. Slave 7-bit address: 0b1000110x (where x = 0 for write and x = 1 for read)
	I2C4_SCL pin	Input/Output	PB15 pin: clock line is used in open-drain mode.
	I2C4_SDA pin	Input/Output	PB14 pin: data line is used in open-drain mode.
SPI1 bootloader	SPI1	Enabled	The SPI1 configuration is: Slave mode, Full Duplex, 8-bit MSB, Speed up to 8MHz, Polarity: CPOL Low, CPHA Low, NSS hardware.
	SPI1_MOSI pin	Input	PA7 pin: Slave data Input line, used in push-pull pull-down mode
	SPI1_MISO pin	Output	PA6 pin: Slave data output line, used in push-pull pull-down mode
	SPI1_SCK pin	Input	PA5 pin: Slave clock line, used in push-pull pull-down mode
	SPI1_NSS pin	Input	PA4 pin: slave chip select pin used in push-pull pull-up mode.
SPI3 bootloader	SPI3	Enabled	The SPI3 configuration is: Slave mode, Full Duplex, 8-bit MSB, Speed up to 8MHz, Polarity: CPOL Low, CPHA Low, NSS hardware.
	SPI3_MOSI pin	Input	PC12 pin: Slave data Input line, used in push-pull pull-down mode
	SPI3_MISO pin	Output	PC11 pin: Slave data output line, used in push-pull pull-down mode
	SPI3_SCK pin	Input	PC10 pin: Slave clock line, used in push-pull pull-down mode
	SPI3_NSS pin	Input	PA15 pin: slave chip select pin used in push-pull pull-up mode.

Table 62. STM32F412xx configuration in system memory boot mode (continued)

Bootloader	Feature/Peripheral	State	Comment
SPI4 bootloader	SPI4	Enabled	The SPI4 configuration is: Slave mode, Full Duplex, 8-bit MSB, Speed up to 8MHz, Polarity: CPOL Low, CPHA Low, NSS hardware.
	SPI4_MOSI pin	Input	PE14 pin: Slave data Input line, used in push-pull pull-down mode
	SPI4_MISO pin	Output	PE13 pin: Slave data output line, used in push-pull pull-down mode
	SP4_SCK pin	Input	PE12 pin: Slave clock line, used in push-pull pull-down mode
	SPI4_NSS pin	Input	PE11 pin: slave chip select pin used in push-pull pull-up mode.
DFU bootloader	USB	Enabled	USB OTG FS configured in forced device mode
	USB_DM pin	Input/Output	PA11 pin: USB DM line.
	USB_DP pin		PA12 pin: USB DP line No external Pull-Up resistor is required.
CAN2 and DFU bootloaders	TIM11	Enabled	This timer is used to determine the value of the HSE. Once HSE frequency is determined, the system clock is configured to 60 MHz using PLL and HSE.

The system clock is derived from the embedded internal high-speed RC for USARTx and I2Cx bootloaders. This internal clock is also used for CAN and DFU (USB FS Device) but only for the selection phase. An external clock multiple of 1 MHz (between 4 and 26 MHz) is required for CAN and DFU bootloader execution after the selection phase.

31.2 Bootloader selection

The *Figure 34* shows the bootloader selection mechanism.

Figure 34.Bootloader V9.x selection for STM32F412xx

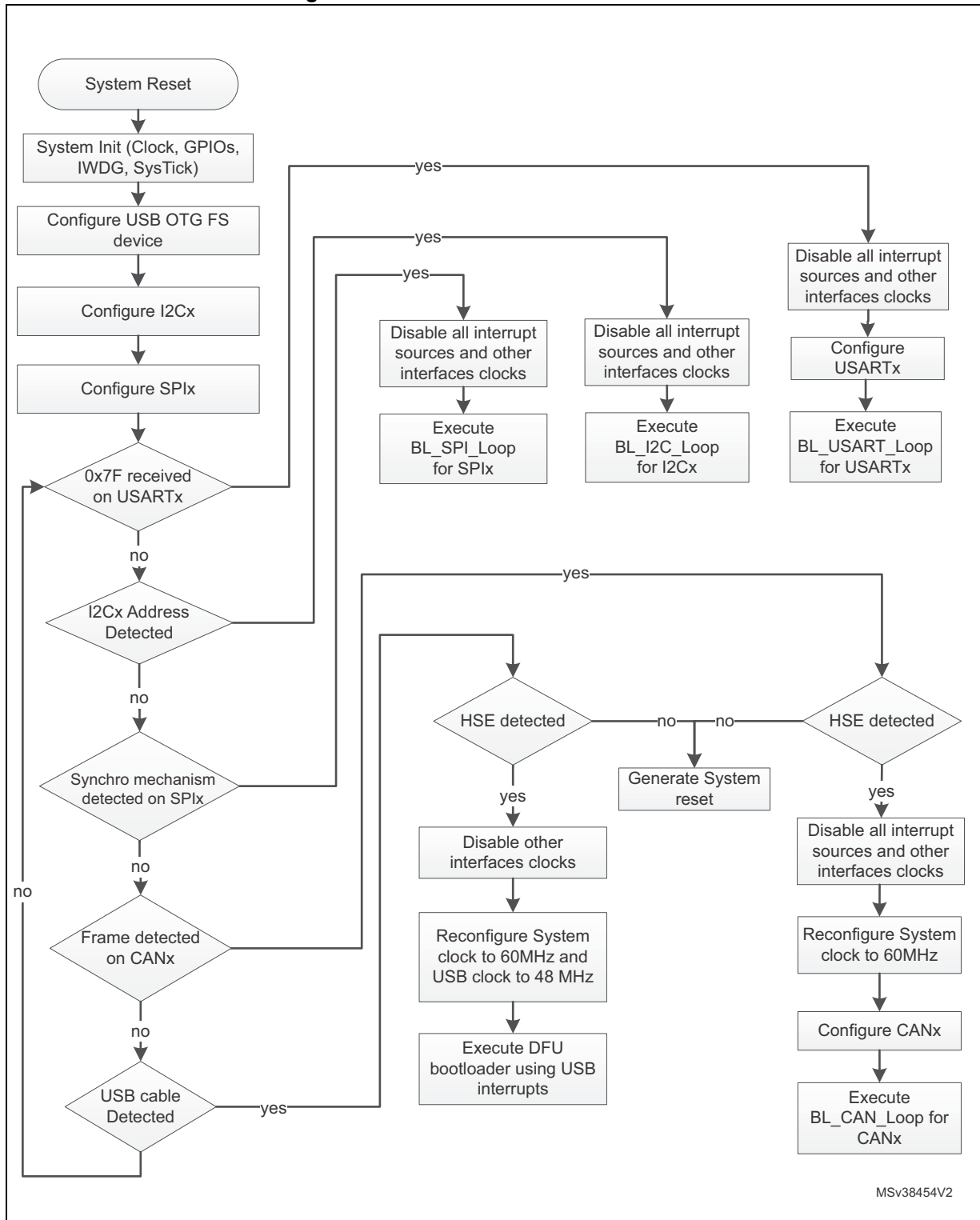

31.3 Bootloader version

The following table lists the STM32F412xx devices bootloader V9.x versions.

Table 63. STM32F412xx bootloader V9.x versions

Bootloader version number	Description	Known limitations
V9.0	Initial bootloader version	After executing Go command (jump to user code) the bootloader resets AHB1ENR value to 0x0000 0000 and thus CCM RAM, when present, is not active (shall be re-enabled by user code at startup)
V9.1	Fix USART3 interface pinout	After executing Go command (jump to user code) the bootloader resets AHB1ENR value to 0x0000 0000 and thus CCM RAM, when present, is not active (shall be re-enabled by user code at startup)

32 STM32F413xx/423xx devices bootloader

32.1 Bootloader configuration

The STM32F413xx/423xx bootloader is activated by applying pattern1 (described in [Table 2: Bootloader activation patterns](#)). The following table shows the hardware resources used by this bootloader.

Table 64. STM32F413xx/423xx configuration in system memory boot mode

Bootloader	Feature/Peripheral	State	Comment
Common to all bootloaders	RCC	HSI enabled	The HSI is used at startup as clock source for system clock configured to 60 MHz and for USART and I2C bootloader operation.
		HSE enabled	The HSE is used only when the CAN or the DFU (USB FS Device) interfaces are selected. In this case the system clock configured to 60 MHz with HSE as clock source. The HSE frequency must be multiple of 1 MHz and ranging from 4 MHz to 26 MHz.
		-	The Clock Security System (CSS) interrupt is enabled for the CAN and DFU bootloaders. Any failure (or removal) of the external clock generates system reset.
	RAM	-	16 Kbyte starting from address 0x20000000 are used by the bootloader firmware
	System memory	-	60 Kbyte starting from address 0x1FF00000, contain the bootloader firmware
	IWDG	-	The independent watchdog (IWDG) prescaler is configured to its maximum value. It is periodically refreshed to prevent watchdog reset (in case the hardware IWDG option was previously enabled by the user).
	Power	-	The voltage range is [1.8V, 3.6V] In this range: <ul style="list-style-type: none"> – Flash wait states 4. – System clock Frequency 60 MHz. – ART Accelerator enabled. – Flash write operation by byte (refer to Bootloader memory management for more information).

Table 64. STM32F413xx/423xx configuration in system memory boot mode (continued)

Bootloader	Feature/Peripheral	State	Comment
USART1 bootloader	USART1	Enabled	Once initialized the USART1 configuration is: 8-bits, even parity and 1 Stop bit
	USART1_RX pin	Input	PA10 pin: USART1 in reception mode
	USART1_TX pin	Output	PA9 pin: USART1 in transmission mode
USART2 bootloader	USART2	Enabled	Once initialized the USART2 configuration is: 8-bits, even parity and 1 Stop bit
	USART2_RX pin	Input	PD6 pin: USART2 in reception mode
	USART2_TX pin	Output	PD5 pin: USART2 in transmission mode
USART3 bootloader	USART3	Enabled	Once initialized the USART3 configuration is: 8-bits, even parity and 1 Stop bit
	USART3_RX pin	Input	PB11 pin: USART3 in reception mode
	USART3_TX pin	Output	PB10 pin: USART3 in transmission mode
USARTx bootloaders	SysTick timer	Enabled	Used to automatically detect the serial baud rate from the host for USARTx bootloaders.
CAN2 bootloader	CAN2	Enabled	Once initialized the CAN2 configuration is: Baudrate 125 kbps, 11-bit identifier. Note: CAN1 is clocked during CAN2 bootloader execution because CAN1 manages the communication between CAN2 and SRAM.
	CAN2_RX pin	Input	PB5 pin: CAN2 in reception mode
	CAN2_TX pin	Output	PB13 pin: CAN2 in transmission mode
I2C1 bootloader	I2C1	Enabled	The I2C1 configuration is: I2C speed: up to 400 KHz, 7-bit address, slave mode, analog filter ON. Slave 7-bit address: 0b1001011x (where x = 0 for write and x = 1 for read)
	I2C1_SCL pin	Input/Output	PB6 pin: clock line is used in open-drain mode.
	I2C1_SDA pin	Input/Output	PB7 pin: data line is used in open-drain mode.

Table 64. STM32F413xx/423xx configuration in system memory boot mode (continued)

Bootloader	Feature/Peripheral	State	Comment
I2C2 bootloader	I2C2	Enabled	The I2C2 configuration is: I2C speed: up to 400 KHz, 7-bit address, slave mode, analog filter ON. Slave 7-bit address: 0b1001011x (where x = 0 for write and x = 1 for read)
	I2C2_SCL pin	Input/Output	PF1 pin: clock line is used in open-drain mode.
	I2C2_SDA pin	Input/Output	PF0 pin: data line is used in open-drain mode.
I2C3 bootloader	I2C3	Enabled	The I2C3 configuration is: I2C speed: up to 400 KHz, 7-bit address, slave mode, analog filter ON. Slave 7-bit address: 0b1001011x (where x = 0 for write and x = 1 for read)
	I2C3_SCL pin	Input/Output	PA8 pin: clock line is used in open-drain mode.
	I2C3_SDA pin	Input/Output	PB4 pin: data line is used in open-drain mode.
I2C4 bootloader	I2C4	Enabled	The I2C4 configuration is: I2C speed: up to 1 MHz, 7-bit address, slave mode, analog filter ON. Slave 7-bit address: 0b1001011x (where x = 0 for write and x = 1 for read)
	I2C4_SCL pin	Input/Output	PB15 pin: clock line is used in open-drain mode.
	I2C4_SDA pin	Input/Output	PB14 pin: data line is used in open-drain mode.
SPI1 bootloader	SPI1	Enabled	The SPI1 configuration is: – Slave mode – Full Duplex – 8-bit MSB, speed up to 8MHz – Polarity: CPOL Low, CPHA Low, NSS hardware.
	SPI1_MOSI pin	Input	PA7 pin: Slave data Input line, used in push-pull pull-down mode
	SPI1_MISO pin	Output	PA6 pin: Slave data output line, used in push-pull pull-down mode
	SPI1_SCK pin	Input	PA5 pin: Slave clock line, used in push-pull pull-down mode
	SPI1_NSS pin	Input	PA4 pin: slave chip select pin used in push-pull pull-up mode.

Table 64. STM32F413xx/423xx configuration in system memory boot mode (continued)

Bootloader	Feature/Peripheral	State	Comment
SPI3 bootloader	SPI3	Enabled	The SPI3 configuration is: – Slave mode – Full Duplex – 8-bit MSB, speed up to 8MHz – Polarity: CPOL Low, CPHA Low, NSS hardware.
	SPI3_MOSI pin	Input	PC12 pin: Slave data Input line, used in push-pull pull-down mode
	SPI3_MISO pin	Output	PC11 pin: Slave data output line, used in push-pull pull-down mode
	SPI3_SCK pin	Input	PC10 pin: Slave clock line, used in push-pull pull-down mode
	SPI3_NSS pin	Input	PA15 pin: slave chip select pin used in push-pull pull-up mode.
SPI4 bootloader	SPI4	Enabled	The SPI4 configuration is: – Slave mode – Full Duplex – 8-bit MSB, speed up to 8MHz – Polarity: CPOL Low, CPHA Low, NSS hardware.
	SPI4_MOSI pin	Input	PE14 pin: Slave data Input line, used in push-pull pull-down mode
	SPI4_MISO pin	Output	PE13 pin: Slave data output line, used in push-pull pull-down mode
	SP4_SCK pin	Input	PE12 pin: Slave clock line, used in push-pull pull-down mode
	SPI4_NSS pin	Input	PE11 pin: slave chip select pin used in push-pull pull-up mode.
DFU bootloader	USB	Enabled	USB OTG FS configured in forced device mode
	USB_DM pin	Input/Output	PA11 pin: USB DM line.
	USB_DP pin		PA12 pin: USB DP line No external Pull-Up resistor is required.
CAN2 and DFU bootloaders	TIM11	Enabled	This timer is used to determine the value of the HSE. Once HSE frequency is determined, the system clock is configured to 60 MHz using PLL and HSE.

The system clock is derived from the embedded internal high-speed RC for USARTx and I2Cx bootloaders. This internal clock is also used for CAN and DFU (USB FS Device) but only for the selection phase. An external clock multiple of 1 MHz (between 4 and 26 MHz) is required for CAN and DFU bootloader execution after the selection phase.

32.2 Bootloader selection

The [Figure 35](#) shows the bootloader selection mechanism.

Figure 35.Bootloader V9.x selection for STM32F413xx/423xx

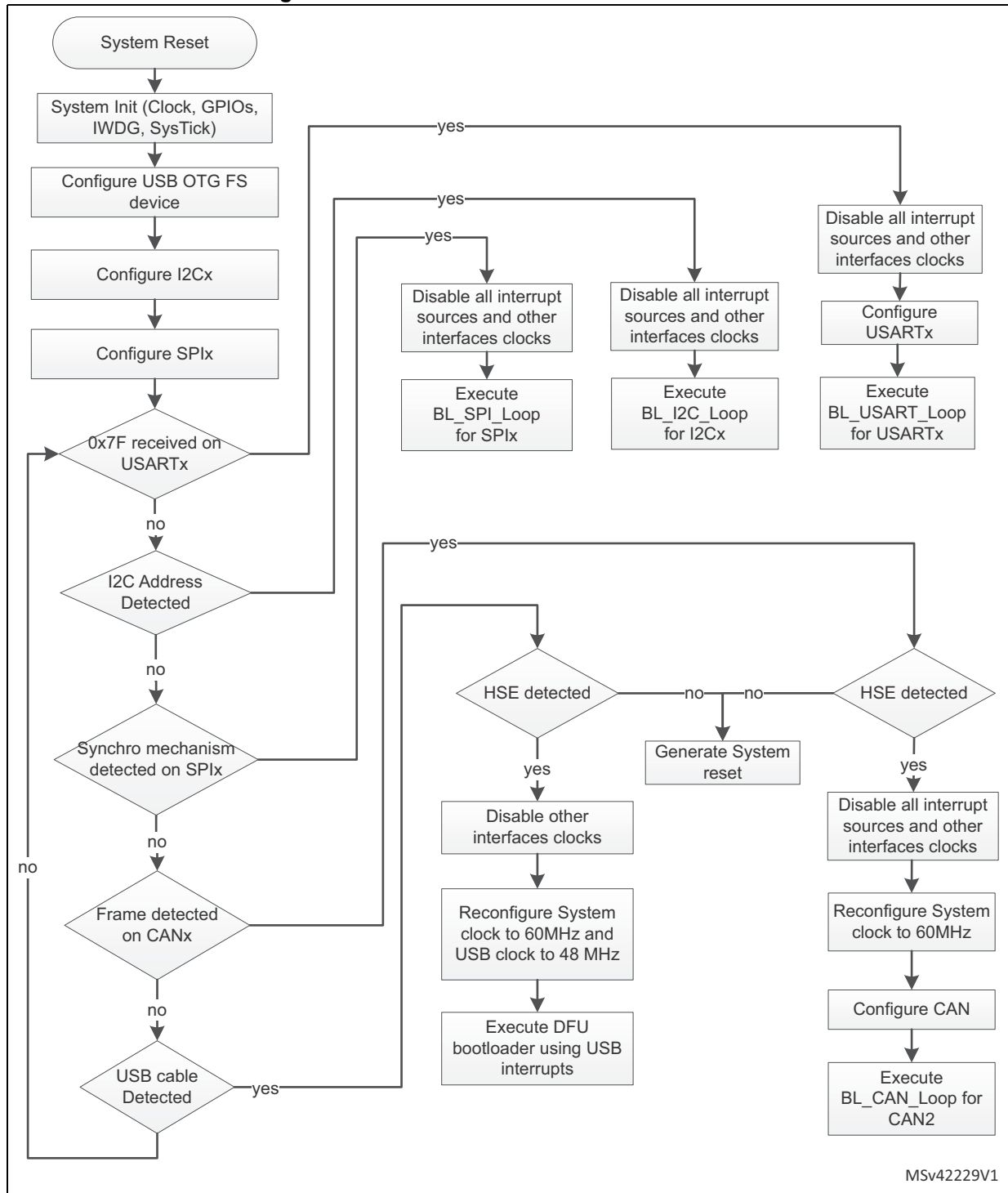

32.3 Bootloader version

The following table lists the STM32F413xx/423xx devices bootloader V9.x versions.

Table 65. STM32F413xx/423xx bootloader V9.x versions

Bootloader version number	Description	Known limitations
V9.0	Initial bootloader version	After executing Go command (jump to user code) the bootloader resets AHB1ENR value to 0x0000 0000 and thus CCM RAM, when present, is not active (shall be re-enabled by user code at startup)

33 STM32F42xxx/43xxx devices bootloader

33.1 Bootloader V7.x

33.1.1 Bootloader configuration

The STM32F42xxx/43xxx bootloader is activated by applying pattern5 (described in [Table 2: Bootloader activation patterns](#)). The following table shows the hardware resources used by this bootloader.

Table 66. STM32F42xxx/43xxx configuration in system memory boot mode

Bootloader	Feature/Peripheral	State	Comment
Common to all bootloaders	RCC	HSI enabled	The system clock frequency is 24 MHz using the PLL. The HSI clock source is used at startup (interface detection phase) and when USART or I2C interfaces are selected (once CAN or DFU bootloader is selected, the clock source will be derived from the external crystal).
		HSE enabled	The system clock frequency is 60 MHz. The HSE clock source is used only when the CAN or the DFU (USB FS Device) interfaces are selected. The external clock must provide a frequency multiple of 1 MHz and ranging from 4 MHz to 26 MHz.
		-	The Clock Security System (CSS) interrupt is enabled for the CAN and DFU bootloaders. Any failure (or removal) of the external clock generates system reset.
	RAM	-	8 Kbyte starting from address 0x20000000 are used by the bootloader firmware
	System memory	-	29 Kbyte starting from address 0x1FFF0000, contain the bootloader firmware
	IWDG	-	The independent watchdog (IWDG) prescaler is configured to its maximum value. It is periodically refreshed to prevent watchdog reset (in case the hardware IWDG option was previously enabled by the user).
	Power	-	Voltage range is set to [1.62 V, 2.1 V]. In this range internal Flash write operations are allowed only in byte format (Half-Word, Word and Double-Word operations are not allowed). The voltage range can be configured in run time using bootloader commands.

Table 66. STM32F42xxx/43xxx configuration in system memory boot mode (continued)

Bootloader	Feature/Peripheral	State	Comment
USART1 bootloader	USART1	Enabled	Once initialized the USART1 configuration is: 8 bits, even parity and 1 Stop bit
	USART1_RX pin	Input	PA10 pin: USART1 in reception mode
	USART1_TX pin	Output	PA9 pin: USART1 in transmission mode
USART3 bootloader (on PB10/PB11)	USART3	Enabled	Once initialized the USART3 configuration is: 8 bits, even parity and 1 Stop bit
	USART3_RX pin	Input	PB11 pin: USART3 in reception mode
	USART3_TX pin	Output	PB10 pin: USART3 in transmission mode
USART3 bootloader (on PC10/PC11)	USART3	Enabled	Once initialized the USART3 configuration is: 8 bits, even parity and 1 Stop bit
	USART3_RX pin	Input	PC11 pin: USART3 in reception mode
	USART3_TX pin	Output	PC10 pin: USART3 in transmission mode
USARTx bootloaders	SysTick timer	Enabled	Used to automatically detect the serial baud rate from the host for USARTx bootloaders.
CAN2 bootloader	CAN2	Enabled	Once initialized the CAN2 configuration is: Baudrate 125 kbps, 11-bit identifier. Note: CAN1 is clocked during CAN2 bootloader execution because CAN1 manages the communication between CAN2 and SRAM.
	CAN2_RX pin	Input	PB5 pin: CAN2 in reception mode
	CAN2_TX pin	Output	PB13 pin: CAN2 in transmission mode
I2C1 bootloader	I2C1	Enabled	The I2C1 configuration is: I2C speed: up to 400 KHz, 7-bit address, slave mode, analog filter ON. Slave 7-bit address: 0b0111000x (where x = 0 for write and x = 1 for read).
	I2C1_SCL pin	Input/Output	PB6 pin: clock line is used in open-drain mode.
	I2C1_SDA pin	Input/Output	PB9 pin: data line is used in open-drain mode.
DFU bootloader	USB	Enabled	USB OTG FS configured in forced device mode
	USB_DM pin	Input/Output	PA11: USB DM line.
	USB_DP pin		PA12: USB DP line No external Pull-up resistor is required
CAN2 and DFU bootloaders	TIM11	Enabled	This timer is used to determine the value of the HSE. Once the HSE frequency is determined, the system clock is configured to 60 MHz using PLL and HSE.

The system clock is derived from the embedded internal high-speed RC for USARTx and I2Cx bootloaders. This internal clock is also used for CAN and DFU (USB FS Device) but only for the selection phase. An external clock multiple of 1 MHz (between 4 and 26 MHz) is required for CAN and DFU bootloader execution after the selection phase.

33.1.2 Bootloader selection

The [Figure 36](#) and [Figure 37](#) show the bootloader selection mechanism.

Figure 36. Dual Bank Boot Implementation for STM32F42xxx/43xxx Bootloader V7.x

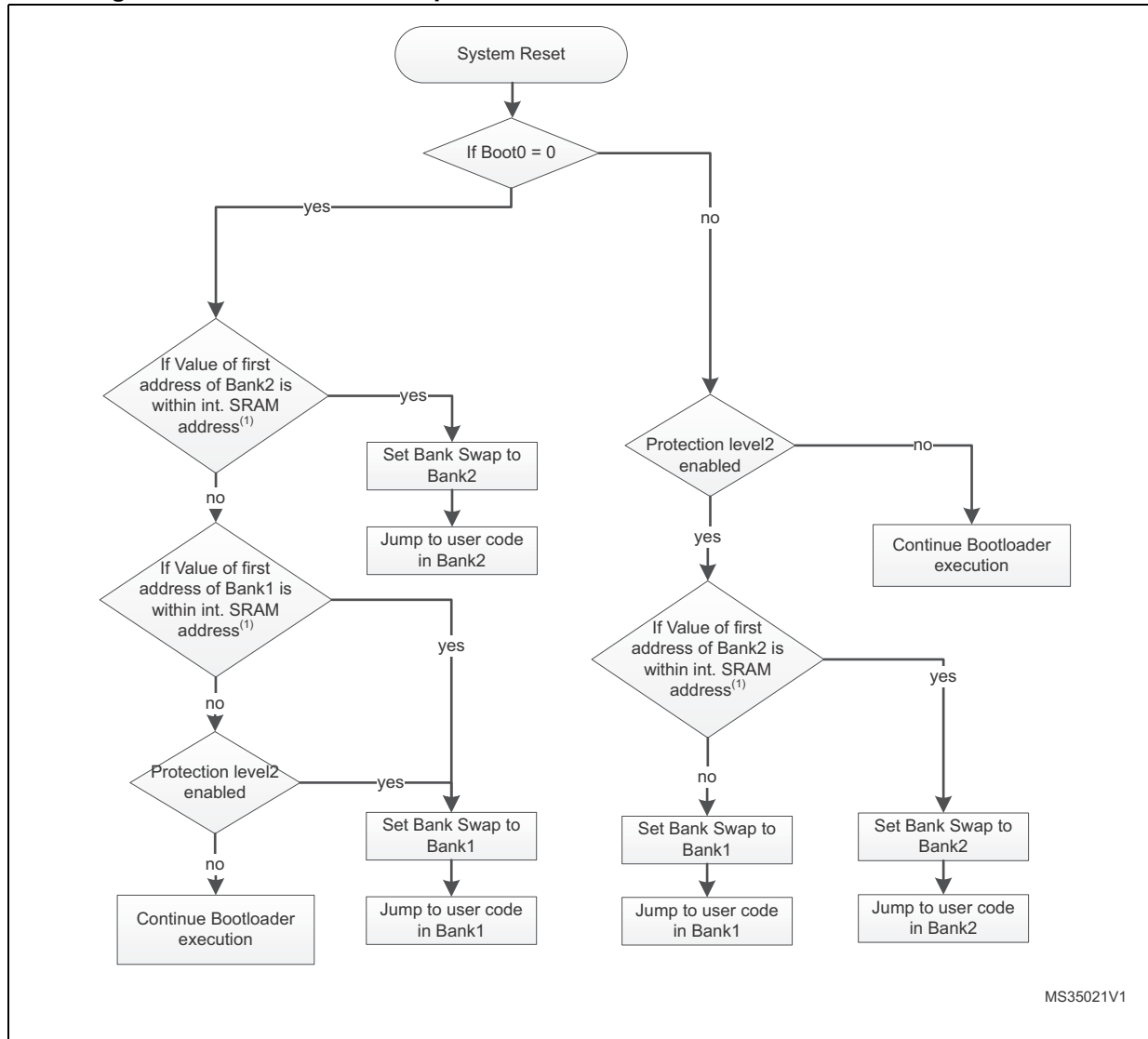

1. CCM RAM is not considered valid as stack pointer address for the dual bank boot mechanism.

Figure 37. Bootloader V7.x selection for STM32F42xxx/43xxx

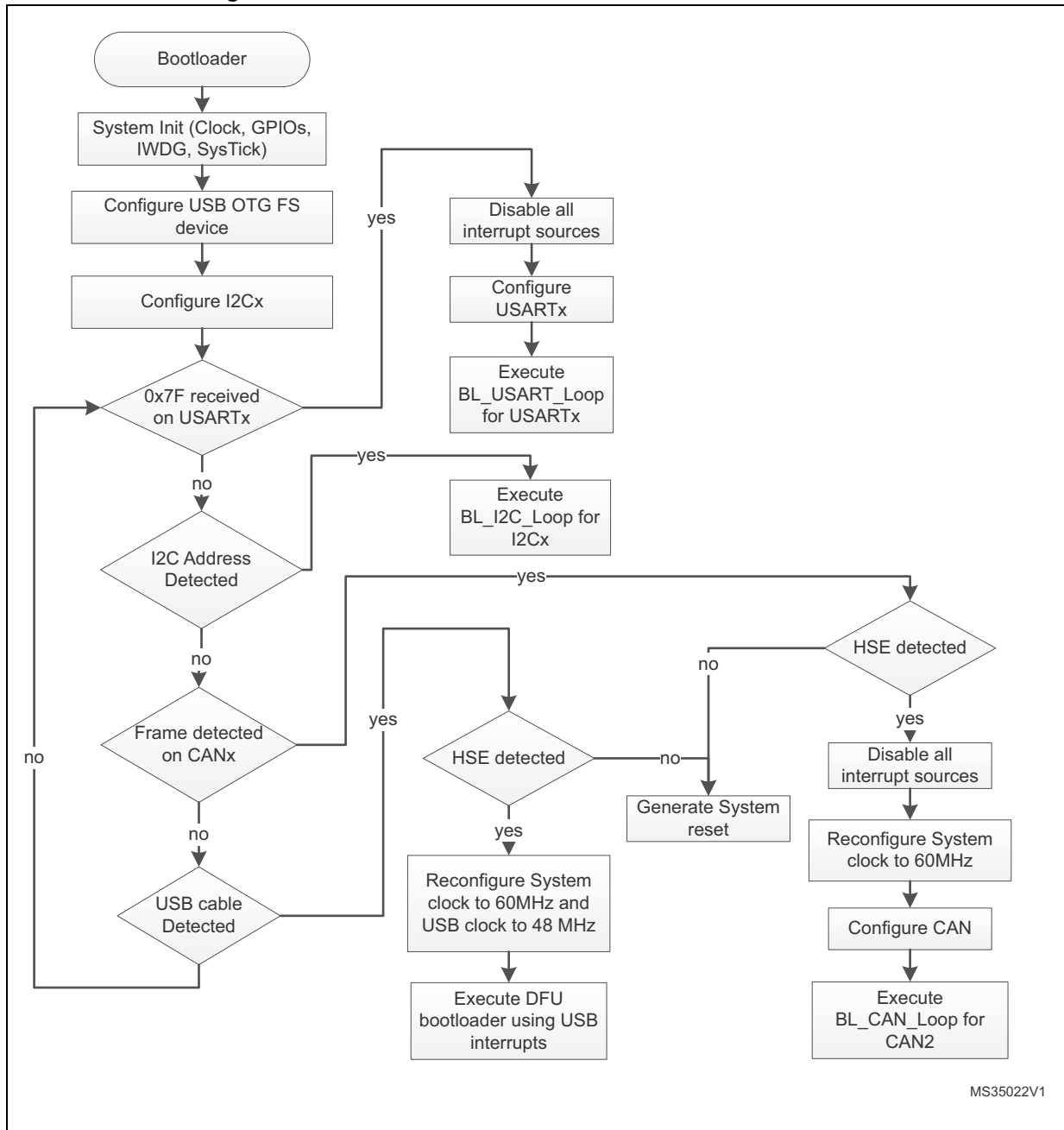

33.1.3 Bootloader version

The following table lists the STM32F42xxx/43xxx devices bootloader V7.x versions.

Table 67. STM32F42xxx/43xxx bootloader V7.x versions

Bootloader version number	Description	Known limitations
V7.0	Initial bootloader version	<p>For the CAN interface, the Write Unprotect command is not functional. Instead you can use Write Memory command and write directly to the option bytes in order to disable the write protection.</p> <p>For the USB DFU interface, in Dual Bank mode, the Erase operation is not functional for the second bank. Instead you can return to Single Bank mode, erase desired sector(s) and then reactivate the Dual Bank mode.</p> <p>After executing Go command (jump to user code) the bootloader resets AHB1ENR value to 0x0000 0000 and thus CCM RAM, when present, is not active (shall be re-enabled by user code at startup)</p>

33.2 Bootloader V9.x

33.2.1 Bootloader configuration

The STM32F42xxx/43xxx bootloader is activated by applying pattern5 (described in [Table 2: Bootloader activation patterns](#)). The following table shows the hardware resources used by this bootloader.

Table 68. STM32F42xxx/43xxx configuration in system memory boot mode

Bootloader	Feature/Peripheral	State	Comment
Common to all bootloaders	RCC	HSI enabled	The system clock frequency is 60 MHz using the PLL. The HSI clock source is used at startup (interface detection phase) and when USART or SPI or I2C interfaces are selected (once CAN or DFU bootloader is selected, the clock source will be derived from the external crystal).
		HSE enabled	The system clock frequency is 60 MHz. The HSE clock source is used only when the CAN or the DFU (USB FS Device) interfaces are selected. The external clock must provide a frequency multiple of 1 MHz and ranging from 4 MHz to 26 MHz.
		-	The Clock Security System (CSS) interrupt is enabled for the CAN and DFU bootloaders. Any failure (or removal) of the external clock generates system reset.
	RAM	-	12 Kbyte starting from address 0x20000000 are used by the bootloader firmware
	System memory	-	29 Kbyte starting from address 0x1FFF0000, contain the bootloader firmware
	IWDG	-	The independent watchdog (IWDG) prescaler is configured to its maximum value. It is periodically refreshed to prevent watchdog reset (in case the hardware IWDG option was previously enabled by the user).
	Power	-	Voltage range is set to [1.62 V, 2.1 V]. In this range internal Flash write operations are allowed only in byte format (Half-Word, Word and Double-Word operations are not allowed). The voltage range can be configured in run time using bootloader commands.
USART1 bootloader	USART1	Enabled	Once initialized the USART1 configuration is: 8-bits, even parity and 1 Stop bit
	USART1_RX pin	Input	PA10 pin: USART1 in reception mode
	USART1_TX pin	Output	PA9 pin: USART1 in transmission mode

Table 68. STM32F42xxx/43xxx configuration in system memory boot mode (continued)

Bootloader	Feature/Peripheral	State	Comment
USART3 bootloader (on PB10/PB11)	USART3	Enabled	Once initialized the USART3 configuration is: 8-bits, even parity and 1 Stop bit
	USART3_RX pin	Input	PB11 pin: USART3 in reception mode
	USART3_TX pin	Output	PB10 pin: USART3 in transmission mode
USART3 bootloader (on PC10/PC11)	USART3	Enabled	Once initialized the USART3 configuration is: 8-bits, even parity and 1 Stop bit
	USART3_RX pin	Input	PC11 pin: USART3 in reception mode
	USART3_TX pin	Output	PC10 pin: USART3 in transmission mode
USARTx bootloaders	SysTick timer	Enabled	Used to automatically detect the serial baud rate from the host for USARTx bootloaders.
CAN2 bootloader	CAN2	Enabled	Once initialized the CAN2 configuration is: Baudrate 125 kbps, 11-bit identifier. Note: CAN1 is clocked during CAN2 bootloader execution because CAN1 manages the communication between CAN2 and SRAM.
	CAN2_RX pin	Input	PB5 pin: CAN2 in reception mode
	CAN2_TX pin	Output	PB13 pin: CAN2 in transmission mode
I2C1 bootloader	I2C1	Enabled	The I2C1 configuration is: I2C speed: up to 400 KHz, 7-bit address, slave mode, analog filter ON. Slave 7-bit address: 0b0111000x (where x = 0 for write and x = 1 for read).
	I2C1_SCL pin	Input/Output	PB6 pin: clock line is used in open-drain mode.
	I2C1_SDA pin	Input/Output	PB9 pin: data line is used in open-drain mode.
I2C2 bootloader	I2C2	Enabled	The I2C2 configuration is: I2C speed: up to 400 KHz, 7-bit address, slave mode, analog filter ON. Slave 7-bit address: 0b0111000x (where x = 0 for write and x = 1 for read).
	I2C2_SCL pin	Input/Output	PF1 pin: clock line is used in open-drain mode.
	I2C2_SDA pin	Input/Output	PF0 pin: data line is used in open-drain mode.
I2C3 bootloader	I2C3	Enabled	The I2C3 configuration is: I2C speed: up to 400 KHz, 7-bit address, slave mode, analog filter ON. Slave 7-bit address: 0b0111000x (where x = 0 for write and x = 1 for read).
	I2C3_SCL pin	Input/Output	PA8 pin: clock line is used in open-drain mode.
	I2C3_SDA pin	Input/Output	PC9 pin: data line is used in open-drain mode.

Table 68. STM32F42xxx/43xxx configuration in system memory boot mode (continued)

Bootloader	Feature/Peripheral	State	Comment
SPI1 bootloader	SPI1	Enabled	The SPI1 configuration is: Slave mode, Full Duplex, -bit MSB, Speed up to 8 MHz, Polarity: CPOL Low, CPHA Low, NSS hardware.
	SPI1_MOSI pin	Input	PA7 pin: Slave data Input line, used in push-pull pull-down mode
	SPI1_MISO pin	Output	PA6 pin: Slave data output line, used in push-pull pull-down mode
	SPI1_SCK pin	Input	PA5 pin: Slave clock line, used in push-pull pull-down mode
	SPI1_NSS pin	Input	PA4 pin: slave chip select pin used in push-pull pull-down mode.
SPI2 bootloader	SPI2	Enabled	The SPI2 configuration is: Slave mode, Full Duplex, 8-bit MSB, Speed up to 8 MHz, Polarity: CPOL Low, CPHA Low, NSS hardware.
	SPI2_MOSI pin	Input	PI3 pin: Slave data Input line, used in push-pull pull-down mode
	SPI2_MISO pin	Output	PI2 pin: Slave data output line, used in push-pull pull-down mode
	SPI2_SCK pin	Input	PI1 pin: Slave clock line, used in push-pull pull-down mode
	SPI2_NSS pin	Input	PI0 pin: slave chip select pin used in push-pull pull-down mode.
SPI4 bootloader	SPI4	Enabled	The SPI4 configuration is: Slave mode, Full Duplex, 8-bit MSB, Speed up to 8 MHz, Polarity: CPOL Low, CPHA Low, NSS hardware.
	SPI4_MOSI pin	Input	PE14 pin: Slave data Input line, used in push-pull pull-down mode
	SPI4_MISO pin	Output	PE13 pin: Slave data output line, used in push-pull pull-down mode
	SP4_SCK pin	Input	PE12 pin: Slave clock line, used in push-pull pull-down mode
	SPI4_NSS pin	Input	PE11 pin: slave chip select pin used in push-pull pull-down mode.
DFU bootloader	USB	Enabled	USB OTG FS configured in forced device mode
	USB_DM pin	Input/Output	PA11: USB DM line.
	USB_DP pin		PA12: USB DP line No external Pull-up resistor is required
CAN2 and DFU bootloaders	TIM11	Enabled	This timer is used to determine the value of the HSE. Once the HSE frequency is determined, the system clock is configured to 60 MHz using PLL and HSE.

The system clock is derived from the embedded internal high-speed RC for USARTx, I2Cx and SPIx bootloaders. This internal clock is also used for CAN and DFU (USB FS Device) but only for the selection phase. An external clock multiple of 1 MHz (between 4 and 26 MHz) is required for CAN and DFU bootloader execution after the selection phase.

33.2.2 Bootloader selection

The [Figure 38](#) and [Figure 39](#) show the bootloader selection mechanism.

Figure 38. Dual Bank Boot Implementation for STM32F42xxx/43xxx bootloader V9.x

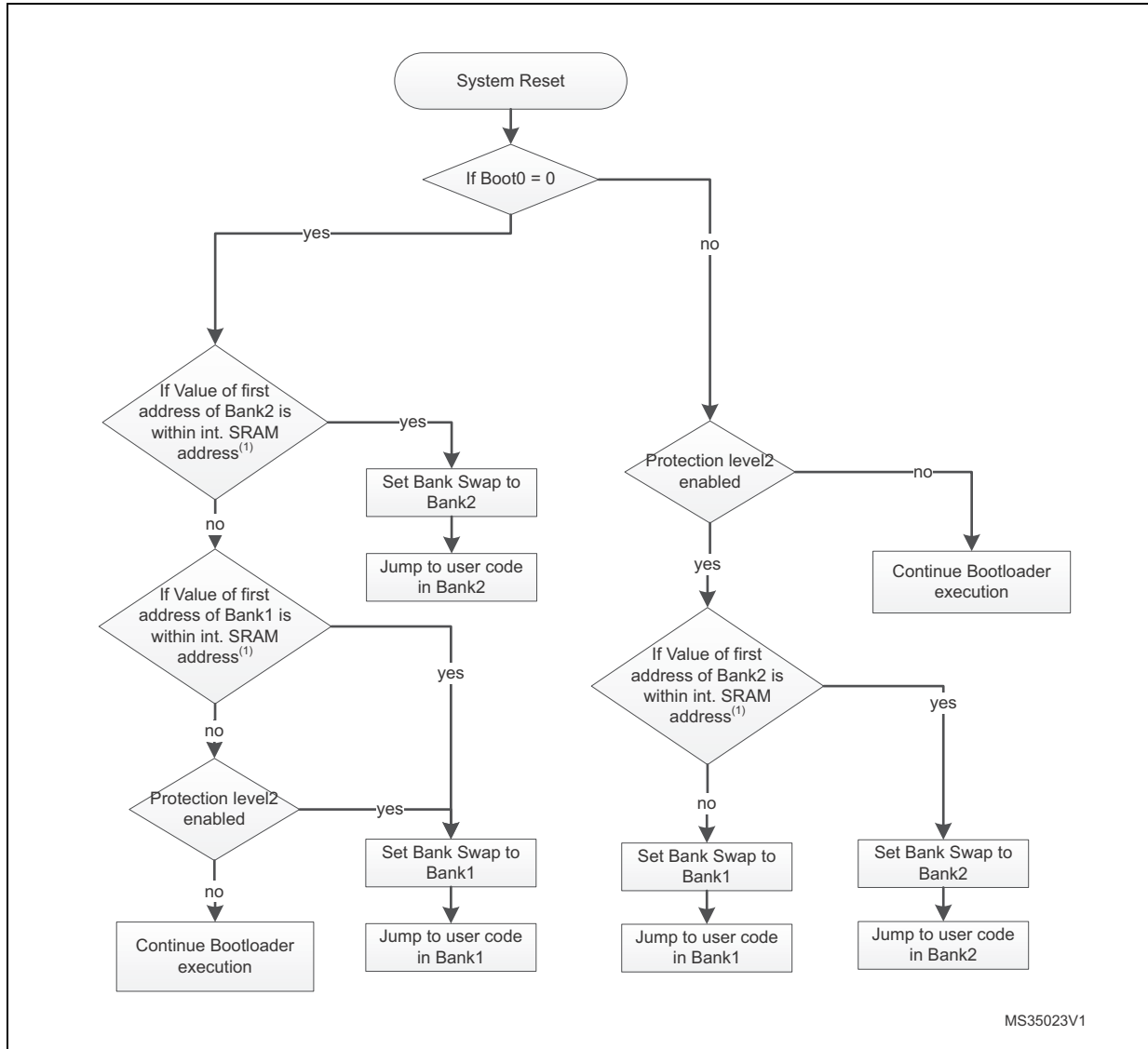

1. CCM RAM is not considered valid as stack pointer address for the dual bank boot mechanism.

Figure 39. Bootloader V9.x selection for STM32F42xxx/43xxx

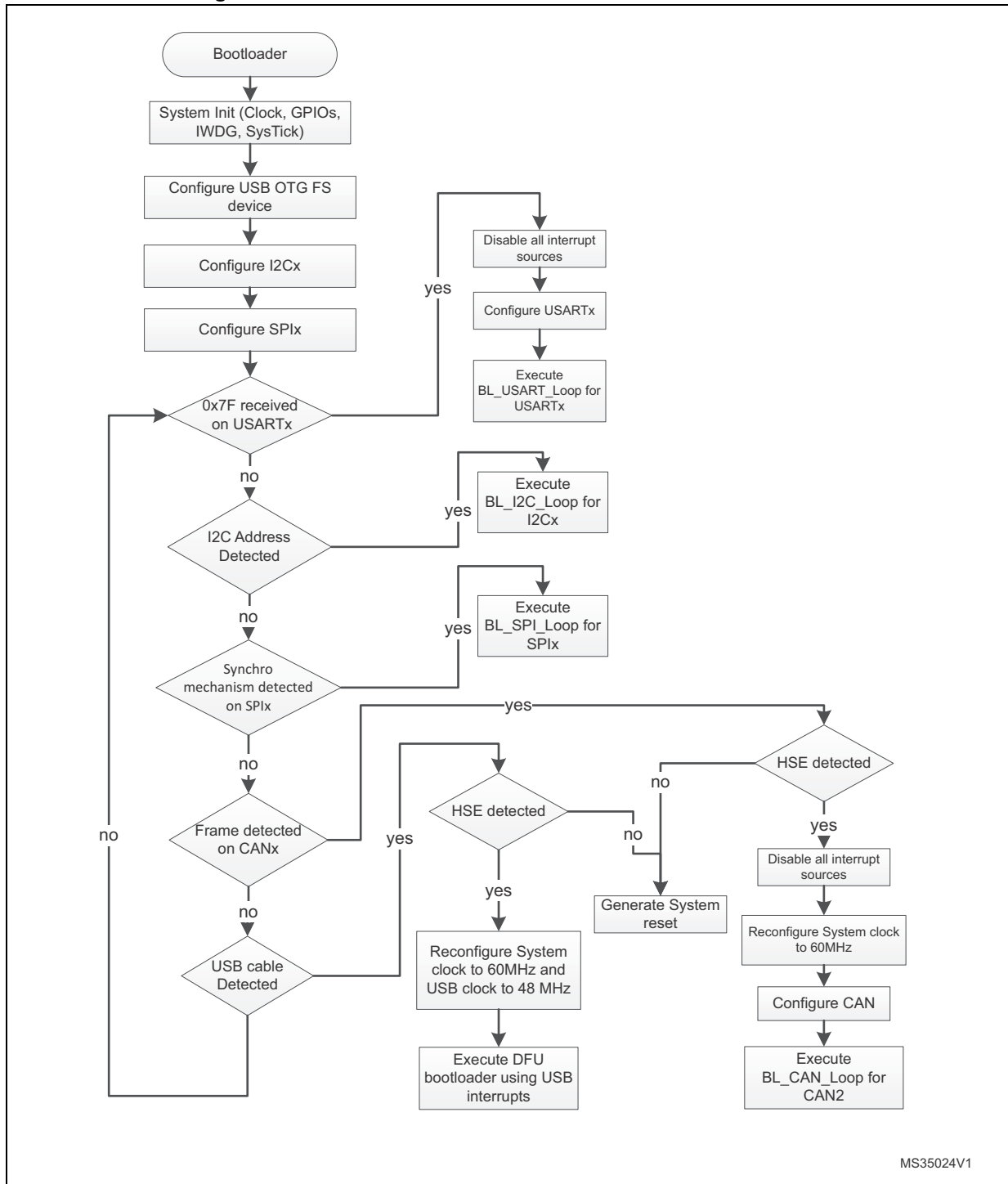

33.2.3 Bootloader version

The following table lists the STM32F42xxx/43xxx devices bootloader V9.x versions.

Table 69. STM32F42xxx/43xxx bootloader V9.x versions

Bootloader version number	Description	Known limitations
V9.0	<p>This bootloader is an updated version of bootloader v7.0. This new version of bootloader supports I2C2, I2C3, SPI1, SPI2 and SPI4 interfaces. The RAM used by this bootloader is increased from 8Kb to 12Kb. The ID of this bootloader is 0x90. The connection time is increased.</p>	<p>For the USB DFU interface, in Dual Bank mode, the Erase operation is not functional for the second bank. Instead you can return to Single Bank mode, erase desired sector(s) and then reactivate the Dual Bank mode.</p> <p>After executing Go command (jump to user code) the bootloader resets AHB1ENR value to 0x0000 0000 and thus CCM RAM, when present, is not active (shall be re-enabled by user code at startup)</p>
V9.1	<p>This bootloader is an updated version of bootloader v9.0. This new version implements the new I2C No-stretch commands (I2C protocol v1.1) and the capability of disabling PcROP when RDP1 is enabled with ReadOutUnprotect command for all protocols(USB, USART, CAN, I2C and SPI). The ID of this bootloader is 0x91</p>	<p>For the CAN interface, the Write Unprotect command is not functional. Instead you can use Write Memory command and write directly to the option bytes in order to disable the write protection.</p> <p>For the USB DFU interface, in Dual Bank mode, the Erase operation is not functional for the second bank. Instead you can return to Single Bank mode, erase desired sector(s) and then reactivate the Dual Bank mode.</p> <p>After executing Go command (jump to user code) the bootloader resets AHB1ENR value to 0x0000 0000 and thus CCM RAM, when present, is not active (shall be re-enabled by user code at startup)</p>

34 STM32F446xx devices bootloader

34.1 Bootloader configuration

The STM32F446xx bootloader is activated by applying pattern1 (described in [Table 2: Bootloader activation patterns](#)). The following table shows the hardware resources used by this bootloader.

Table 70. STM32F446xx configuration in system memory boot mode

Bootloader	Feature/Peripheral	State	Comment
Common to all bootloaders	RCC	HSI enabled	The HSI is used at startup as clock source for system clock configured to 60 MHz and for USART, I2C and SPI bootloader operation.
		HSE enabled	The HSE is used only when the CAN or the DFU (USB FS Device) interfaces are selected. In this case the system clock configured to 60 MHz with HSE as clock source. The HSE frequency must be multiple of 1 MHz and ranging from 4 MHz to 26 MHz.
		-	The Clock Security System (CSS) interrupt is enabled for the CAN and DFU bootloaders. Any failure (or removal) of the external clock generates system reset.
	RAM	-	12 Kbyte starting from address 0x20000000 are used by the bootloader firmware
	System memory	-	29 Kbyte starting from address 0x1FFF0000, contain the bootloader firmware
	IWDG	-	The independent watchdog (IWDG) prescaler is configured to its maximum value. It is periodically refreshed to prevent watchdog reset (in case the hardware IWDG option was previously enabled by the user).
	Power	-	The voltage range is [1.71 V, 3.6 V]. In this range: - Flash wait states 3. - System Clock 60 MHz. - Prefetch disabled. - Flash write operation by byte (refer to section bootloader memory management for more information).

Table 70. STM32F446xx configuration in system memory boot mode (continued)

Bootloader	Feature/Peripheral	State	Comment
USART1 bootloader	USART1	Enabled	Once initialized the USART1 configuration is: 8-bits, even parity and 1 Stop bit
	USART1_RX pin	Input	PA10 pin: USART1 in reception mode
	USART1_TX pin	Output	PA9 pin: USART1 in transmission mode
USART3 bootloader (on PB10/PB11)	USART3	Enabled	Once initialized the USART3 configuration is: 8-bits, even parity and 1 Stop bit
	USART3_RX pin	Input	PB11 pin: USART3 in reception mode
	USART3_TX pin	Output	PB10 pin: USART3 in transmission mode
USART3 bootloader (on PC10/PC11)	USART3	Enabled	Once initialized the USART3 configuration is: 8-bits, even parity and 1 Stop bit
	USART3_RX pin	Input	PC11 pin: USART3 in reception mode
	USART3_TX pin	Output	PC10 pin: USART3 in transmission mode
USARTx bootloaders	SysTick timer	Enabled	Used to automatically detect the serial baud rate from the host for USARTx bootloaders.
CAN2 bootloader	CAN2	Enabled	Once initialized the CAN2 configuration is: Baudrate 125 kbps, 11-bit identifier. Note: CAN1 is clocked during CAN2 bootloader execution because in CAN1 manages the communication between CAN2 and SRAM.
	CAN2_RX pin	Input	PB5 pin: CAN2 in reception mode
	CAN2_TX pin	Output	PB13 pin: CAN2 in transmission mode
I2C1 bootloader	I2C1	Enabled	The I2C1 configuration is: I2C speed: up to 400 KHz, 7-bit address, slave mode, analog filter ON. Slave 7-bit address: 0b0111100x (where x = 0 for write and x = 1 for read)
	I2C1_SCL pin	Input/Output	PB6 pin: clock line is used in open-drain mode.
	I2C1_SDA pin	Input/Output	PB9 pin: data line is used in open-drain mode.
I2C2 bootloader	I2C2	Enabled	The I2C2 configuration is: I2C speed: up to 400 KHz, 7-bit address, slave mode, analog filter ON. Slave 7-bit address: 0b0111100x (where x = 0 for write and x = 1 for read)
	I2C2_SCL pin	Input/Output	PF1 pin: clock line is used in open-drain mode.
	I2C2_SDA pin	Input/Output	PF0 pin: data line is used in open-drain mode.

Table 70. STM32F446xx configuration in system memory boot mode (continued)

Bootloader	Feature/Peripheral	State	Comment
I2C3 bootloader	I2C3	Enabled	The I2C3 configuration is: I2C speed: up to 400 KHz, 7-bit address, slave mode, analog filter ON. Slave 7-bit address: 0b0111100x (where x = 0 for write and x = 1 for read)
	I2C3_SCL pin	Input/Output	PA8 pin: clock line is used in open-drain mode.
	I2C3_SDA pin	Input/Output	PC9 pin: data line is used in open-drain mode.
SPI1 bootloader	SPI1	Enabled	The SPI1 configuration is: Slave mode, Full Duplex, 8-bit MSB, Speed up to 8 MHz, Polarity: CPOL Low, CPHA Low, NSS hardware.
	SPI1_MOSI pin	Input	PA7 pin: Slave data Input line, used in push-pull pull-down mode
	SPI1_MISO pin	Output	PA6 pin: Slave data output line, used in push-pull pull-down mode
	SPI1_SCK pin	Input	PA5 pin: Slave clock line, used in push-pull pull-down mode
SPI2 bootloader	SPI1_NSS pin	Input	PA4 pin: slave chip select pin used in push-pull pull-up mode.
	SPI2	Enabled	The SPI2 configuration is: Slave mode, Full Duplex, 8-bit MSB, Speed up to 8 MHz, Polarity: CPOL Low, CPHA Low, NSS hardware.
	SPI2_MOSI pin	Input	PB15 pin: Slave data Input line, used in push-pull pull-down mode
	SPI2_MISO pin	Output	PB14 pin: Slave data output line, used in push-pull pull-down mode
	SPI2_SCK pin	Input	PC7 pin: Slave clock line, used in push-pull pull-down mode
	SPI2_NSS pin	Input	PB12 pin: slave chip select pin used in push-pull pull-up mode.

Table 70. STM32F446xx configuration in system memory boot mode (continued)

Bootloader	Feature/Peripheral	State	Comment
SPI4 bootloader	SPI4	Enabled	The SPI4 configuration is: Slave mode, Full Duplex, 8-bit MSB, Speed up to 8 MHz, Polarity: CPOL Low, CPHA Low, NSS hardware.
	SPI4_MOSI pin	Input	PE14 pin: Slave data Input line, used in push-pull pull-down mode
	SPI4_MISO pin	Output	PE13 pin: Slave data output line, used in push-pull pull-down mode
	SPI4_SCK pin	Input	PE12 pin: Slave clock line, used in push-pull pull-down mode
	SPI4_NSS pin	Input	PE11 pin: slave chip select pin used in push-pull pull-up mode.
DFU bootloader	USB	Enabled	USB OTG FS configured in forced device mode
	USB_DM pin	Input/Output	PA11: USB DM line.
	USB_DP pin		PA12: USB DP line No external Pull-up resistor is required
CAN2 and DFU bootloaders	TIM17	Enabled	This timer is used to determine the value of the HSE. Once the HSE frequency is determined, the system clock is configured to 60 MHz using PLL and HSE.

The system clock is derived from the embedded internal high-speed RC for USARTx and I2Cx bootloaders. This internal clock is also used for CAN and DFU (USB FS Device) but only for the selection phase. An external clock multiple of 1 MHz (between 4 and 26 MHz) is required for CAN and DFU bootloader execution after the selection phase.

34.2 Bootloader selection

The figure below shows the bootloader selection mechanism.

Figure 40.Bootloader V9.x selection for STM32F446xx

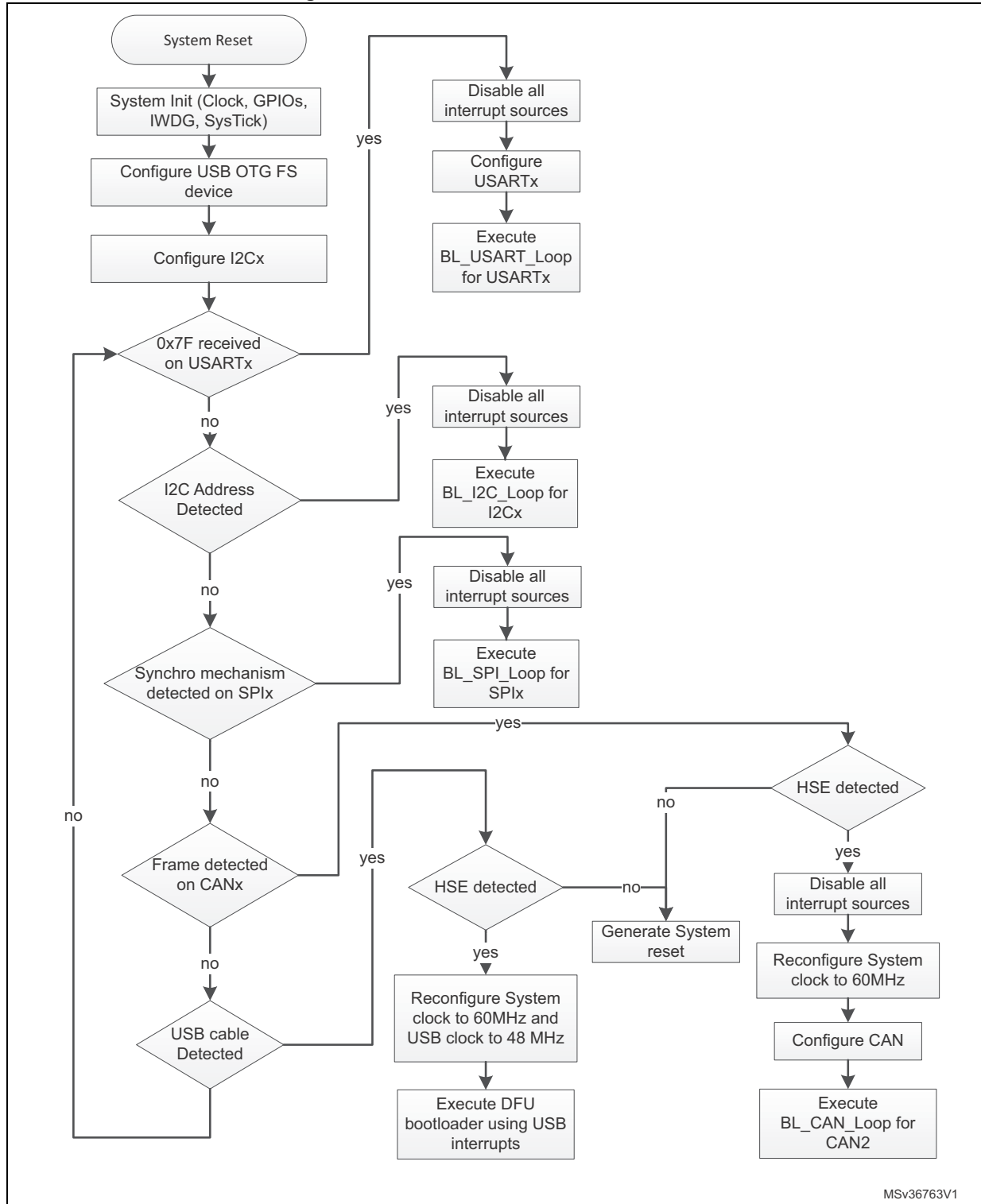

MSv36763V1

34.3 Bootloader version

The following table lists the STM32F446xx devices bootloader V9.x versions:

Table 71. STM32F446xx bootloader V9.x versions

Bootloader version number	Description	Known limitations
V9.0	Initial bootloader version	After executing Go command (jump to user code) the bootloader resets AHB1ENR value to 0x0000 0000 and thus CCM RAM, when present, is not active (shall be re-enabled by user code at startup)

35 STM32F469xx/479xx devices bootloader

35.1 Bootloader configuration

The STM32F469xx/479xx bootloader is activated by applying pattern5 (described in [Table 2: Bootloader activation patterns](#)). The following table shows the hardware resources used by this bootloader.

Table 72. STM32F469xx/479xx configuration in system memory boot mode

Bootloader	Feature/Peripheral	State	Comment
Common to all bootloaders	RCC	HSI enabled	The system clock frequency is 60 MHz using the PLL. The HSI clock source is used at startup (interface detection phase) and when USART or SPI or I2C interfaces are selected (once CAN or DFU bootloader is selected, the clock source will be derived from external crystal).
		HSE enabled	The system clock frequency is 60 MHz. The HSE clock source is used only when the CAN or the DFU (USB FS Device) interfaces are selected. The external clock must provide a frequency multiple of 1 MHz and ranging from 4 MHz to 26 MHz.
		-	The Clock Security System (CSS) interrupt is enabled for the CAN and DFU bootloaders. Any failure (or removal) of the external clock generates system reset.
	RAM	-	12 Kbyte starting from address 0x20000000 are used by the bootloader firmware
	System memory	-	29 Kbyte starting from address 0x1FFF0000, contain the bootloader firmware
	IWDG	-	The independent watchdog (IWDG) prescaler is configured to its maximum value. It is periodically refreshed to prevent watchdog reset (in case the hardware IWDG option was previously enabled by the user).
	Power	-	Voltage range is set to [1.62 V, 2.1 V]. In this range internal Flash write operations are allowed only in byte format (Half-Word, Word and Double-Word operations are not allowed). The voltage range can be configured in run time using bootloader commands.

Table 72. STM32F469xx/479xx configuration in system memory boot mode (continued)

Bootloader	Feature/Peripheral	State	Comment
USART1 bootloader	USART1	Enabled	Once initialized the USART1 configuration is: 8-bits, even parity and 1 Stop bit
	USART1_RX pin	Input	PA10 pin: USART1 in reception mode
	USART1_TX pin	Output	PA9 pin: USART1 in transmission mode
USART3 bootloader (on PB10/PB11)	USART3	Enabled	Once initialized the USART3 configuration is: 8-bits, even parity and 1 Stop bit
	USART3_RX pin	Input	PB11 pin: USART3 in reception mode
	USART3_TX pin	Output	PB10 pin: USART3 in transmission mode
USART3 bootloader (on PC10/PC11)	USART3	Enabled	Once initialized the USART3 configuration is: 8-bits, even parity and 1 Stop bit
	USART3_RX pin	Input	PC11 pin: USART3 in reception mode
	USART3_TX pin	Output	PC10 pin: USART3 in transmission mode
USARTx bootloaders	SysTick timer	Enabled	Used to automatically detect the serial baud rate from the host for USARTx bootloaders.
CAN2 bootloader	CAN2	Enabled	Once initialized the CAN2 configuration is: Baudrate 125 kbps, 11-bit identifier. Note: CAN1 is clocked during CAN2 bootloader execution because CAN1 manages the communication between CAN2 and SRAM.
	CAN2_RX pin	Input	PB05 pin: CAN2 in reception mode
	CAN2_TX pin	Output	PB13 pin: CAN2 in transmission mode
I2C1 bootloader	I2C1	Enabled	The I2C1 configuration is: I2C speed: up to 400 KHz, 7-bit address, slave mode, analog filter ON. Slave 7-bit address: 0b1000100x (where x = 0 for write and x = 1 for read).
	I2C1_SCL pin	Input/Output	PB6 pin: clock line is used in open-drain mode.
	I2C1_SDA pin	Input/Output	PB9 pin: data line is used in open-drain mode.
I2C2 bootloader	I2C2	Enabled	The I2C2 configuration is: I2C speed: up to 400 KHz, 7-bit address, slave mode, analog filter ON. Slave 7-bit address: 0b1000100x (where x = 0 for write and x = 1 for read).
	I2C2_SCL pin	Input/Output	PF0 pin: clock line is used in open-drain mode.
	I2C2_SDA pin	Input/Output	PF1 pin: data line is used in open-drain mode.

Table 72. STM32F469xx/479xx configuration in system memory boot mode (continued)

Bootloader	Feature/Peripheral	State	Comment
I2C3 bootloader	I2C3	Enabled	The I2C3 configuration is: I2C speed: up to 400 KHz, 7-bit address, slave mode, analog filter ON. Slave 7-bit address: 0b1000100x (where x = 0 for write and x = 1 for read).
	I2C3_SCL pin	Input/Output	PA8 pin: clock line is used in open-drain mode.
	I2C3_SDA pin	Input/Output	PC9 pin: data line is used in open-drain mode.
SPI1 bootloader	SPI1	Enabled	The SPI1 configuration is: Slave mode, Full Duplex, 8-bit MSB, Speed up to 8 MHz, Polarity: CPOL Low, CPHA Low, NSS hardware.
	SPI1_MOSI pin	Input	PA7 pin: Slave data Input line, used in push-pull pull-down mode
	SPI1_MISO pin	Output	PA6 pin: Slave data output line, used in push-pull pull-down mode
	SPI1_SCK pin	Input	PA5 pin: Slave clock line, used in push-pull pull-down mode
	SPI1_NSS pin	Input	PA4 pin: slave chip select pin used in push-pull pull-up mode.
SPI2 bootloader	SPI2	Enabled	The SPI2 configuration is: Slave mode, Full Duplex, 8-bit MSB, Speed up to 8 MHz, Polarity: CPOL Low, CPHA Low, NSS hardware.
	SPI2_MOSI pin	Input	PI3 pin: Slave data Input line, used in push-pull pull-down mode
	SPI2_MISO pin	Output	PI2 pin: Slave data output line, used in push-pull pull-down mode
	SPI2_SCK pin	Input	PI1 pin: Slave clock line, used in push-pull pull-down mode
	SPI2_NSS pin	Input	PI0 pin: slave chip select pin used in push-pull pull-up mode.

Table 72. STM32F469xx/479xx configuration in system memory boot mode (continued)

Bootloader	Feature/Peripheral	State	Comment
SPI4 bootloader	SPI4	Enabled	The SPI4 configuration is: Slave mode, Full Duplex, 8-bit MSB, Speed up to 8 MHz, Polarity: CPOL Low, CPHA Low, NSS hardware.
	SPI4_MOSI pin	Input	PE14 pin: Slave data Input line, used in push-pull pull-down mode
	SPI4_MISO pin	Output	PE13 pin: Slave data output line, used in push-pull pull-down mode
	SP4_SCK pin	Input	PE12 pin: Slave clock line, used in push- pull pull-down mode
	SPI4_NSS pin	Input	PE11 pin: slave chip select pin used in push-pull pull-up mode.
DFU bootloader	USB	Enabled	USB OTG FS configured in forced device mode. USB_OTG_FS interrupt vector is enabled and used for USB DFU communications.
	USB_DM pin	Input/Output	PA11 pin: USB DM line.
	USB_DP pin		PA12 pin: USB DP line. No external Pull-Up resistor is required.

The system clock is derived from the embedded internal high-speed RC for USARTx and I2Cx bootloaders. This internal clock is also used for CAN and DFU (USB FS Device) but only for the selection phase. An external clock multiple of 1 MHz (between 4 and 48 MHz) is required for CAN and DFU bootloaders execution after the selection phase.

35.2 Bootloader selection

The [Figure 41](#) and [Figure 42](#) show the bootloader selection mechanism.

Figure 41. Dual Bank Boot Implementation for STM32F469xx/479xx Bootloader V9.x

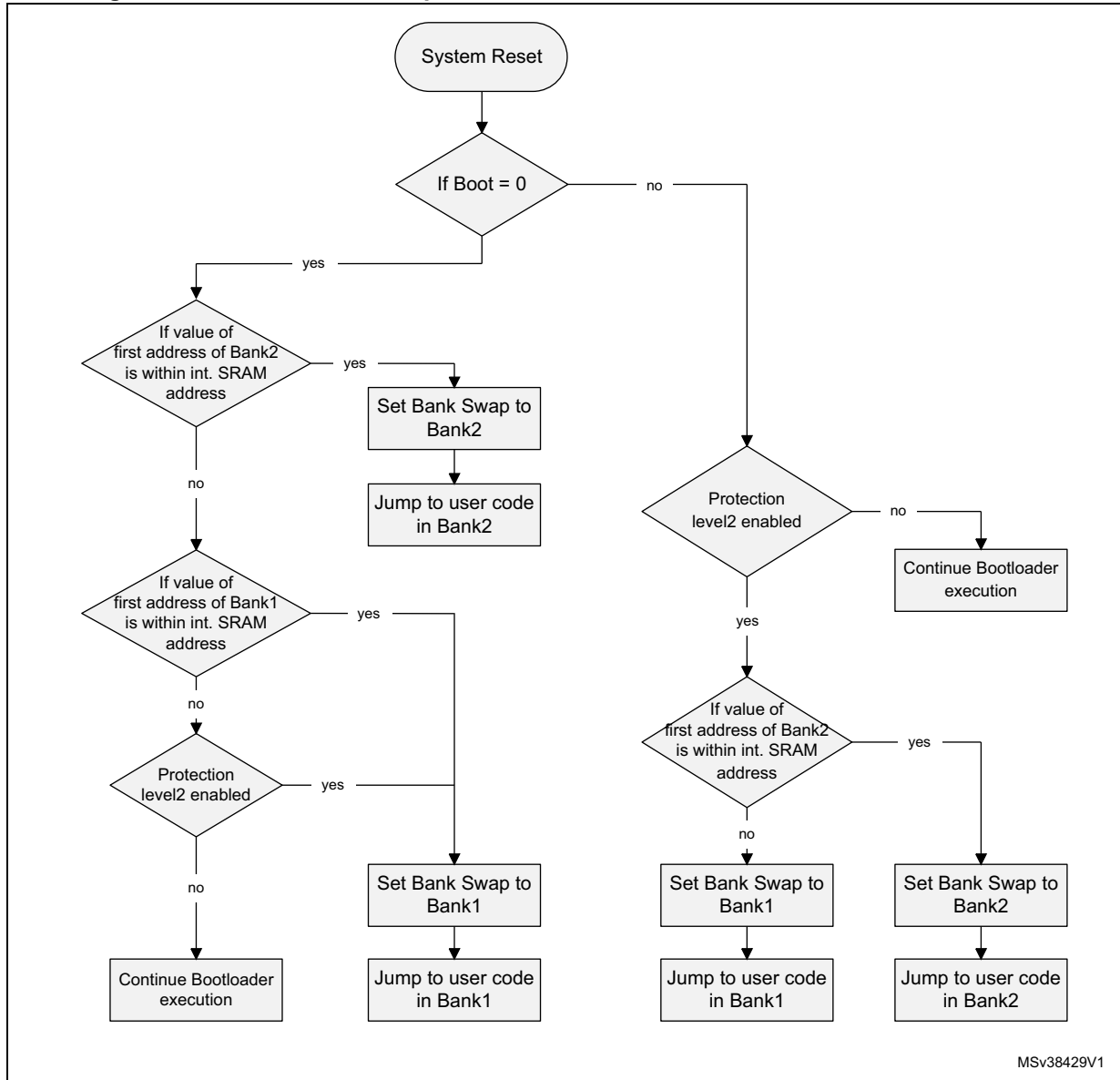

MSv38429V1

Figure 42.Bootloader V9.x selection for STM32F469xx/479xx

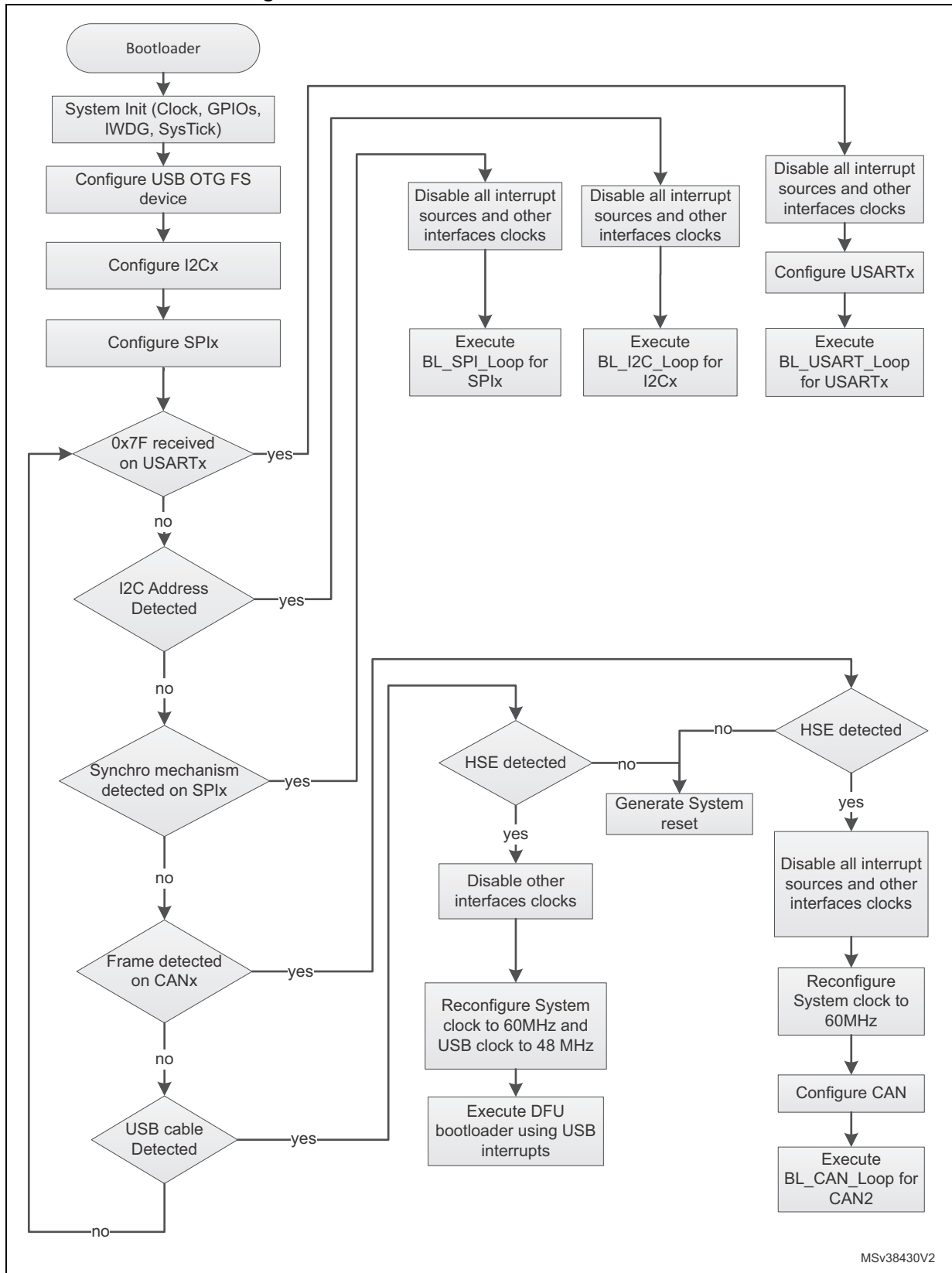

MSv38430V2



35.3 Bootloader version

The following table lists the STM32F469xx/479xx devices V9.x bootloader versions:

Table 73. STM32F469xx/479xx bootloader V9.x versions

Bootloader version number	Description	Known limitations
V9.0	Initial bootloader version	After executing Go command (jump to user code) the bootloader resets AHB1ENR value to 0x0000 0000 and thus CCM RAM, when present, is not active (shall be re-enabled by user code at startup)

36 STM32F72xxx/73xxx devices bootloader

36.1 Bootloader configuration

The STM32F72xxx/73xxx bootloader is activated by applying pattern8 (described in [Table 2: Bootloader activation patterns](#)). The [Table 74](#) shows the hardware resources used by this bootloader.

Table 74. STM32F72xxx/73xxx configuration in system memory boot mode

Bootloader	Feature/Peripheral	State	Comment
Common to all bootloaders	RCC	HSI enabled	The HSI is used at startup as clock source for system clock configured to 60 MHz and for USART and I2C bootloader operation.
		HSE enabled	The HSE is used only when the CAN or the DFU (USB FS Device) interfaces are selected. In this case the system clock configured to 60 MHz with HSE as clock source. The HSE frequency must be multiple of 1 MHz and ranging from 4 MHz to 26 MHz.
		-	The Clock Security System (CSS) interrupt is enabled for the CAN and DFU bootloaders. Any failure (or removal) of the external clock generates system reset.
	RAM	-	16 Kbyte starting from address 0x20000000 are used by the bootloader firmware
	System memory	-	59 Kbyte starting from address 0x1FF00000, contain the bootloader firmware
	IWDG	-	The independent watchdog (IWDG) prescaler is configured to its maximum value. It is periodically refreshed to prevent watchdog reset (in case the hardware IWDG option was previously enabled by the user).
	Power	-	The voltage range is [1.8V, 3.6V] In this range: - Flash wait states 3. - System clock Frequency 60 MHz. - ART Accelerator enabled. - Flash write operation by byte (refer to bootloader memory management section for more information).

Table 74. STM32F72xxx/73xxx configuration in system memory boot mode (continued)

Bootloader	Feature/Peripheral	State	Comment
USART1 bootloader	USART1	Enabled	Once initialized the USART1 configuration is: 8-bits, even parity and 1 Stop bit
	USART1_RX pin	Input	PA10 pin: USART1 in reception mode
	USART1_TX pin	Output	PA9 pin: USART1 in transmission mode
USART3 bootloader (on PB11/PB10)	USART3	Enabled	Once initialized the USART3 configuration is: 8-bits, even parity and 1 Stop bit
	USART3_RX pin	Input	PB11 pin: USART3 in reception mode
	USART3_TX pin	Output	PB10 pin: USART3 in transmission mode
USART3 bootloader (on PC11/PC10)	USART3	Enabled	Once initialized the USART3 configuration is: 8-bits, even parity and 1 Stop bit
	USART3_RX pin	Input	PC11 pin: USART3 in reception mode
	USART3_TX pin	Output	PC10 pin: USART3 in transmission mode
USARTx bootloaders	SysTick timer	Enabled	Used to automatically detect the serial baud rate from the host for USARTx bootloaders.
CAN1 bootloader	CAN1	Enabled	Once initialized the CAN1 configuration is: Baudrate 125 kbps, 11-bit identifier.
	CAN1_RX pin	Input	PD0 pin: CAN1 in reception mode
	CAN1_TX pin	Output	PD1 pin: CAN1 in transmission mode
I2C1 bootloader	I2C1	Enabled	The I2C1 configuration is: I2C speed: up to 400 KHz, 7-bit address, slave mode, analog filter ON. Slave 7-bit address: 0b1001001x (where x = 0 for write and x = 1 for read)
	I2C1_SCL pin	Input/Output	PB6 pin: clock line is used in open-drain mode.
	I2C1_SDA pin	Input/Output	PB9 pin: data line is used in open-drain mode.

Table 74. STM32F72xxx/73xxx configuration in system memory boot mode (continued)

Bootloader	Feature/Peripheral	State	Comment
I2C2 bootloader	I2C2	Enabled	The I2C2 configuration is: I2C speed: up to 400 KHz, 7-bit address, slave mode, analog filter ON. Slave 7-bit address: 0b1001101x (where x = 0 for write and x = 1 for read)
	I2C2_SCL pin	Input/Output	PF1 pin: clock line is used in open-drain mode.
	I2C2_SDA pin	Input/Output	PF0 pin: data line is used in open-drain mode.
I2C3 bootloader	I2C3	Enabled	The I2C3 configuration is: I2C speed: up to 400 KHz, 7-bit address, slave mode, analog filter ON. Slave 7-bit address: 0b1001001x (where x = 0 for write and x = 1 for read)
	I2C3_SCL pin	Input/Output	PA8 pin: clock line is used in open-drain mode.
	I2C3_SDA pin	Input/Output	PC9 pin: data line is used in open-drain mode.
SPI1 bootloader	SPI1	Enabled	The SPI1 configuration is: Slave mode, Full Duplex, 8-bit MSB, Speed up to 8MHz, Polarity: CPOL Low, CPHA Low, NSS hardware.
	SPI1_MOSI pin	Input	PA7 pin: Slave data Input line, used in push-pull pull-down mode
	SPI1_MISO pin	Output	PA6 pin: Slave data output line, used in push-pull pull-down mode
	SPI1_SCK pin	Input	PA5 pin: Slave clock line, used in push-pull pull-down mode
	SPI1_NSS pin	Input	PA4 pin: slave chip select pin used in push-pull pull-up mode.
SPI2 bootloader	SPI2	Enabled	The SPI2 configuration is: Slave mode, Full Duplex, 8-bit MSB, Speed up to 8MHz, Polarity: CPOL Low, CPHA Low, NSS hardware.
	SPI2_MOSI pin	Input	PI3 pin: Slave data Input line, used in push-pull pull-down mode
	SPI2_MISO pin	Output	PI2 pin: Slave data output line, used in push-pull pull-down mode
	SPI2_SCK pin	Input	PI1 pin: Slave clock line, used in push-pull pull-down mode
	SPI2_NSS pin	Input	PI0 pin: slave chip select pin used in push-pull pull-up mode.

Table 74. STM32F72xxx/73xxx configuration in system memory boot mode (continued)

Bootloader	Feature/Peripheral	State	Comment
SPI4 bootloader	SPI4	Enabled	The SPI4 configuration is: Slave mode, Full Duplex, 8-bit MSB, Speed up to 8MHz, Polarity: CPOL Low, CPHA Low, NSS hardware.
	SPI4_MOSI pin	Input	PE14 pin: Slave data Input line, used in push-pull pull-down mode
	SPI4_MISO pin	Output	PE13 pin: Slave data output line, used in push-pull pull-down mode
	SP4_SCK pin	Input	PE12 pin: Slave clock line, used in push-pull pull-down mode
	SPI4_NSS pin	Input	PE11 pin: slave chip select pin used in push-pull pull-up mode.
DFU bootloader	USB	Enabled	USB OTG FS configured in forced device mode
	USB_DM pin	Input/Output	PA11 pin: USB DM line.
	USB_DP pin		PA12 pin: USB DP line No external Pull-Up resistor is required.
CAN1 and DFU bootloaders	TIM11	Enabled	This timer is used to determine the value of the HSE. Once HSE frequency is determined, the system clock is configured to 60 MHz using PLL and HSE.

The system clock is derived from the embedded internal high-speed RC for USARTx and I2Cx bootloaders. This internal clock is also used for CAN and DFU (USB FS Device) but only for the selection phase. An external clock multiple of 1 MHz (between 4 and 26 MHz) is required for CAN and DFU bootloader execution after the selection phase.

36.2 Bootloader selection

The [Figure 43](#) below show the bootloader selection mechanism:

Figure 43. Bootloader V9.x selection for STM32F72xxx/73xxx

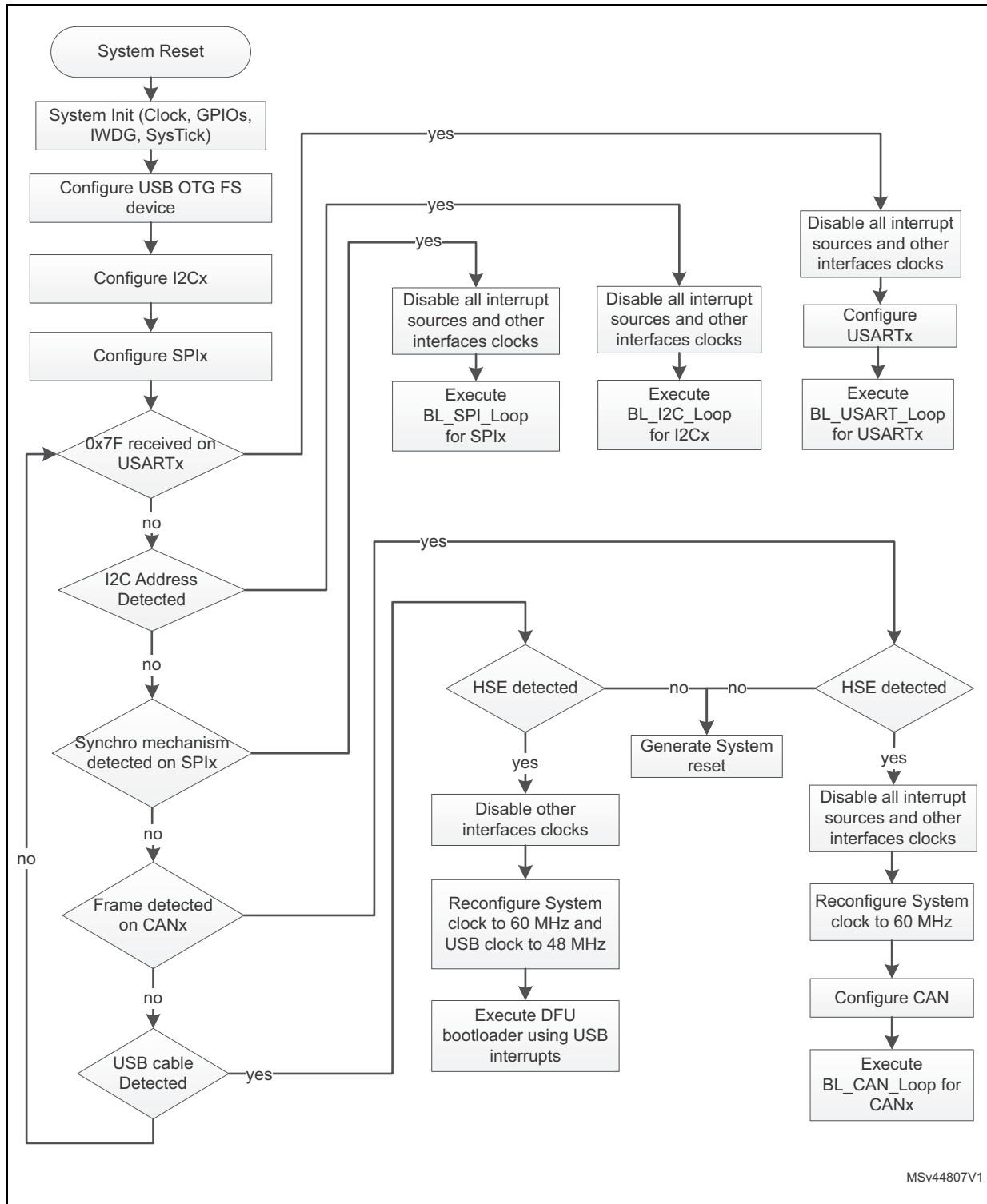

MSv44807V1

36.3 Bootloader version

The [Table 75](#) lists the STM32F72xxx/73xxx devices bootloader V9.x versions.

Table 75. STM32F72xxx/73xxx bootloader V9.x versions

Bootloader version number	Description	Known limitations
V9.0	Initial bootloader version	None

37 STM32F74xxx/75xxx devices bootloader

Two bootloader versions are available on STM32F74xxx/75xxx:

- V7.x supporting USART1, USART3, CAN2, I2C1, I2C2, I2C3 and DFU (USB FS Device). This version is embedded in STM32F74xxx/75xxx rev. A devices.
- V9.x supporting USART1, USART3, CAN2, I2C1, I2C2, I2C3, SPI1, SPI2, SPI4 and DFU (USB FS Device). This version is embedded in STM32F74xxx/75xxx rev. Z devices.

Note: When readout protection Level2 is activated, STM32F74xxx/75xxx devices can boot also on system memory and all commands are not accessible except *Get*, *GetID*, and *GetVersion*.

37.1 Bootloader V7.x

37.1.1 Bootloader configuration

The STM32F74xxx/75xxx bootloader is activated by applying pattern8 (described in [Table 2: Bootloader activation patterns](#)). The following table shows the hardware resources used by this bootloader.

Table 76. STM32F74xxx/75xxx configuration in system memory boot mode

Bootloader	Feature/Peripheral	State	Comment
Common to all bootloaders	RCC	HSI enabled	The HSI is used at startup as clock source for system clock configured to 60 MHz and for USART and I2C bootloader operation.
		HSE enabled	The HSE is used only when the CAN or the DFU (USB FS Device) interfaces are selected. In this case the system clock configured to 60 MHz with HSE as clock source. The HSE frequency must be multiple of 1 MHz and ranging from 4 MHz to 26 MHz.
		-	The Clock Security System (CSS) interrupt is enabled for the CAN and DFU bootloaders. Any failure (or removal) of the external clock generates system reset.
	RAM	-	16 Kbyte starting from address 0x20000000 are used by the bootloader firmware
	System memory	-	60 Kbyte starting from address 0x1FF00000, contain the bootloader firmware
	IWDG	-	The independent watchdog (IWDG) prescaler is configured to its maximum value. It is periodically refreshed to prevent watchdog reset (in case the hardware IWDG option was previously enabled by the user).
	Power	-	The voltage range is [1.8V, 3.6V]. In this range: - Flash wait states 3. - System clock Frequency 60 MHz. - ART Accelerator enabled. - Flash write operation by byte (refer to bootloader memory management section for more information).
USART1 bootloader	USART1	Enabled	Once initialized the USART1 configuration is: 8-bits, even parity and 1 Stop bit
	USART1_RX pin	Input	PA10 pin: USART1 in reception mode
	USART1_TX pin	Output	PA9 pin: USART1 in transmission mode
USART3 bootloader (on PB10/PB11)	USART3	Enabled	Once initialized the USART3 configuration is: 8-bits, even parity and 1 Stop bit
	USART3_RX pin	Input	PB11 pin: USART3 in reception mode
	USART3_TX pin	Output	PB10 pin: USART3 in transmission mode
USART3 bootloader (on PC10/PC11)	USART3	Enabled	Once initialized the USART3 configuration is: 8-bits, even parity and 1 Stop bit
	USART3_RX pin	Input	PC11 pin: USART3 in reception mode
	USART3_TX pin	Output	PC10 pin: USART3 in transmission mode
USARTx bootloaders	SysTick timer	Enabled	Used to automatically detect the serial baud rate from the host for USARTx bootloaders.

Table 76. STM32F74xxx/75xxx configuration in system memory boot mode (continued)

Bootloader	Feature/Peripheral	State	Comment
CAN2 bootloader	CAN2	Enabled	Once initialized the CAN2 configuration is: Baudrate 125 kbps, 11-bit identifier. Note: CAN1 is clocked during CAN2 bootloader execution because CAN1 manages the communication between CAN2 and SRAM.
	CAN2_RX pin	Input	PB5 pin: CAN2 in reception mode
	CAN2_TX pin	Output	PB13 pin: CAN2 in transmission mode
I2C1 bootloader	I2C1	Enabled	The I2C1 configuration is: I2C speed: up to 400 KHz, 7-bit address, slave mode, analog filter ON. Slave 7-bit address: 0b1000101x (where x = 0 for write and x = 1 for read)
	I2C1_SCL pin	Input/Output	PB6 pin: clock line is used in open-drain mode.
	I2C1_SDA pin	Input/Output	PB9 pin: data line is used in open-drain mode.
I2C2 bootloader	I2C2	Enabled	The I2C2 configuration is: I2C speed: up to 400 KHz, 7-bit address, slave mode, analog filter ON. Slave 7-bit address: 0b1000101x (where x = 0 for write and x = 1 for read)
	I2C2_SCL pin	Input/Output	PF1 pin: clock line is used in open-drain mode.
	I2C2_SDA pin	Input/Output	PF0 pin: data line is used in open-drain mode.
I2C3 bootloader	I2C3	Enabled	The I2C3 configuration is: I2C speed: up to 400 KHz, 7-bit address, slave mode, analog filter ON. Slave 7-bit address: 0b1000101x (where x = 0 for write and x = 1 for read)
	I2C3_SCL pin	Input/Output	PA8 pin: clock line is used in open-drain mode.
	I2C3_SDA pin	Input/Output	PC9 pin: data line is used in open-drain mode.
DFU bootloader	USB	Enabled	USB OTG FS configured in forced device mode.
	USB_DM pin	Input/Output	PA11 pin: USB DM line.
	USB_DP pin		PA12 pin: USB DP line No external Pull-Up resistor is required.
CAN2 and DFU bootloaders	TIM11	Enabled	This timer is used to determine the value of the HSE. Once HSE frequency is determined, the system clock is configured to 60 MHz using PLL and HSE.

The system clock is derived from the embedded internal high-speed RC for USARTx and I2Cx bootloaders. This internal clock is also used for CAN and DFU (USB FS Device) but only for the selection phase. An external clock multiple of 1 MHz (between 4 and 26 MHz) is required for CAN and DFU bootloader execution after the selection phase.

37.1.2 Bootloader selection

The figure below shows the bootloader selection mechanism.

Figure 44.Bootloader V7.x selection for STM32F74xxx/75xxx

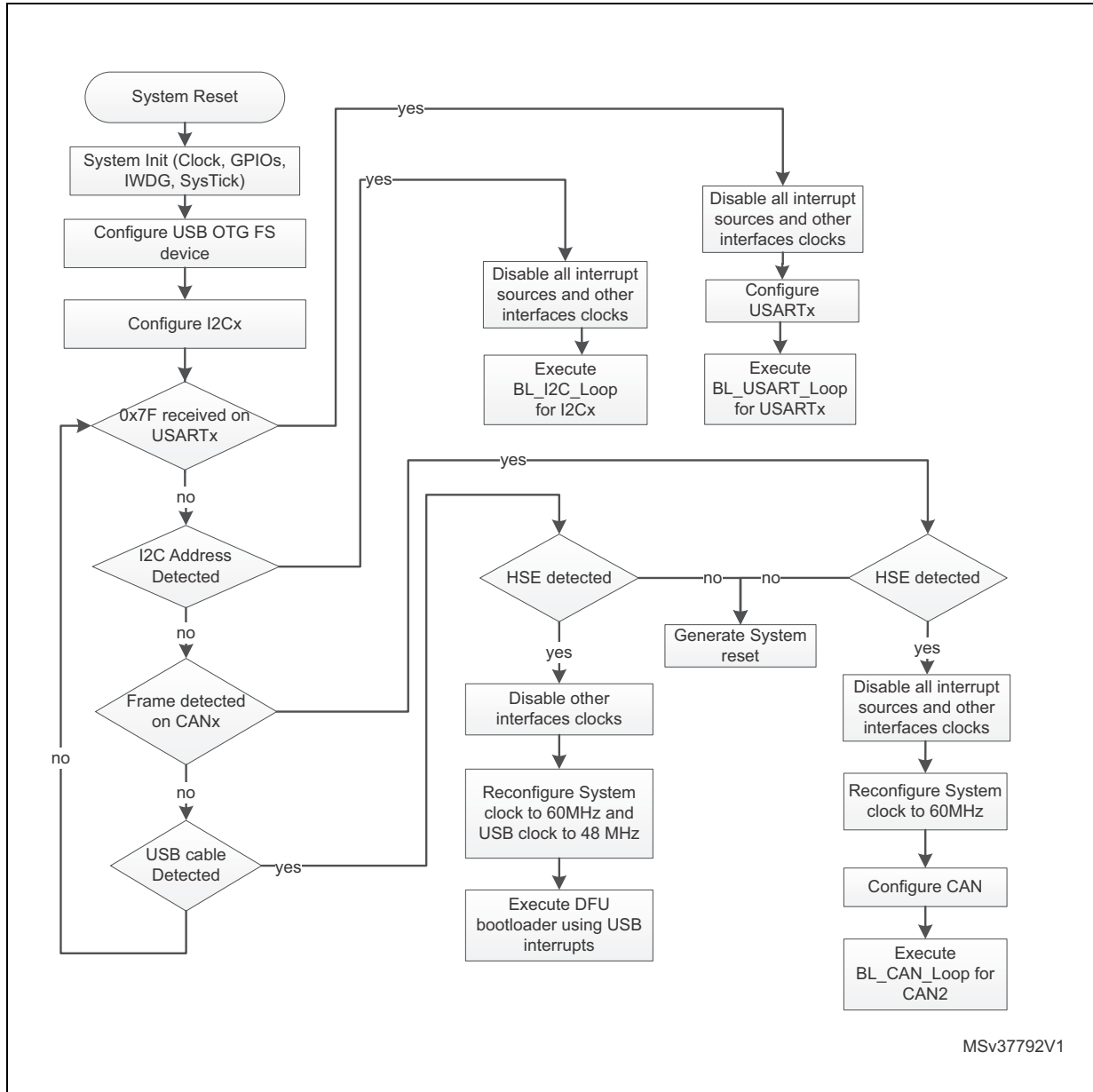

37.1.3 Bootloader version

The following table lists the STM32F74xxx/75xxx devices bootloader V7.x versions:

Table 77. STM32F74xxx/75xxx bootloader V7.x versions

Bootloader version number	Description	Known limitations
V7.0	Initial bootloader version	None

37.2 Bootloader V9.x

37.2.1 Bootloader configuration

The STM32F74xxx/75xxx bootloader is activated by applying pattern8 (described in [Table 2: Bootloader activation patterns](#)). The following table shows the hardware resources used by this bootloader.

Table 78. STM32F74xxx/75xxx configuration in system memory boot mode

Bootloader	Feature/Peripheral	State	Comment
Common to all bootloaders	RCC	HSI enabled	The HSI is used at startup as clock source for system clock configured to 60 MHz and for USART, I2C and SPI bootloader operation.
		HSE enabled	The HSE is used only when the CAN or the DFU (USB FS Device) interfaces are selected. In this case the system clock configured to 60 MHz with HSE as clock source. The HSE frequency must be multiple of 1 MHz and ranging from 4 MHz to 26 MHz.
		-	The Clock Security System (CSS) interrupt is enabled for the CAN and DFU bootloaders. Any failure (or removal) of the external clock generates system reset.
	RAM	-	16 Kbyte starting from address 0x20000000 are used by the bootloader firmware
	System memory	-	60 Kbyte starting from address 0x1FF00000, contain the bootloader firmware
	IWDG	-	The independent watchdog (IWDG) prescaler is configured to its maximum value. It is periodically refreshed to prevent watchdog reset (in case the hardware IWDG option was previously enabled by the user).
	Power	-	The voltage range is [1.8V, 3.6V] In this range: - Flash wait states 3. - System clock Frequency 60 MHz. - ART Accelerator enabled. - Flash write operation by byte (refer to bootloader memory management section for more information).

Table 78. STM32F74xxx/75xxx configuration in system memory boot mode (continued)

Bootloader	Feature/Peripheral	State	Comment
USART1 bootloader	USART1	Enabled	Once initialized the USART1 configuration is: 8-bits, even parity and 1 Stop bit
	USART1_RX pin	Input	PA10 pin: USART1 in reception mode
	USART1_TX pin	Output	PA9 pin: USART1 in transmission mode
USART3 bootloader (on PB10/PB11)	USART3	Enabled	Once initialized the USART3 configuration is: 8-bits, even parity and 1 Stop bit
	USART3_RX pin	Input	PB11 pin: USART3 in reception mode
	USART3_TX pin	Output	PB10 pin: USART3 in transmission mode
USART3 bootloader (on PC10/PC11)	USART3	Enabled	Once initialized the USART3 configuration is: 8-bits, even parity and 1 Stop bit
	USART3_RX pin	Input	PC11 pin: USART3 in reception mode
	USART3_TX pin	Output	PC10 pin: USART3 in transmission mode
USARTx bootloaders	SysTick timer	Enabled	Used to automatically detect the serial baud rate from the host for USARTx bootloaders.
CAN2 bootloader	CAN2	Enabled	Once initialized the CAN2 configuration is: Baudrate 125 kbps, 11-bit identifier. Note: CAN1 is clocked during CAN2 bootloader execution because CAN1 manages the communication between CAN2 and SRAM.
	CAN2_RX pin	Input	PB5 pin: CAN2 in reception mode
	CAN2_TX pin	Output	PB13 pin: CAN2 in transmission mode
I2C1 bootloader	I2C1	Enabled	The I2C1 configuration is: I2C speed: up to 400 KHz, 7-bit address, slave mode, analog filter ON. Slave 7-bit address: 0b1000101x (where x = 0 for write and x = 1 for read)
	I2C1_SCL pin	Input/output	PB6 pin: clock line is used in open-drain mode.
	I2C1_SDA pin	Input/output	PB9 pin: data line is used in open-drain mode.
I2C2 bootloader	I2C2	Enabled	The I2C2 configuration is: I2C speed: up to 400 KHz, 7-bit address, slave mode, analog filter ON. Slave 7-bit address: 0b1000101x (where x = 0 for write and x = 1 for read)
	I2C2_SCL pin	Input/output	PF1 pin: clock line is used in open-drain mode.
	I2C2_SDA pin	Input/output	PF0 pin: data line is used in open-drain mode.

Table 78. STM32F74xxx/75xxx configuration in system memory boot mode (continued)

Bootloader	Feature/Peripheral	State	Comment
I2C3 bootloader	I2C3	Enabled	The I2C3 configuration is: I2C speed: up to 400 KHz, 7-bit address, slave mode, analog filter ON. Slave 7-bit address: 0b1000101x (where x = 0 for write and x = 1 for read)
	I2C3_SCL pin	Input/output	PA8 pin: clock line is used in open-drain mode.
	I2C3_SDA pin	Input/output	PC9 pin: data line is used in open-drain mode.
SPI1 bootloader	SPI1	Enabled	The SPI1 configuration is: Slave mode, Full Duplex, 8-bit MSB, Speed up to 8 MHz, Polarity: CPOL Low, CPHA Low, NSS hardware.
	SPI1_MOSI pin	Input	PA7 pin: Slave data Input line, used in push-pull pull-down mode
	SPI1_MISO pin	Output	PA6 pin: Slave data output line, used in push-pull pull-down mode
	SPI1_SCK pin	Input	PA5 pin: Slave clock line, used in push-pull pull-down mode
	SPI1_NSS pin	Input	PA4 pin: slave chip select pin used in push-pull pull-up mode.
SPI2 bootloader	SPI2	Enabled	The SPI2 configuration is: Slave mode, Full Duplex, 8-bit MSB, Speed up to 8 MHz, Polarity: CPOL Low, CPHA Low, NSS hardware.
	SPI2_MOSI pin	Input	PI3 pin: Slave data Input line, used in push-pull pull-down mode
	SPI2_MISO pin	Output	PI2 pin: Slave data output line, used in push-pull pull-down mode
	SPI2_SCK pin	Input	PI1 pin: Slave clock line, used in push-pull pull-down mode
	SPI2_NSS pin	Input	PI0 pin: slave chip select pin used in push-pull pull-up mode.

Table 78. STM32F74xxx/75xxx configuration in system memory boot mode (continued)

Bootloader	Feature/Peripheral	State	Comment
SPI4 bootloader	SPI4	Enabled	The SPI4 configuration is: Slave mode, Full Duplex, 8-bit MSB, Speed up to 8 MHz, Polarity: CPOL Low, CPHA Low, NSS hardware.
	SPI4_MOSI pin	Input	PE14 pin: Slave data Input line, used in push-pull pull-down mode
	SPI4_MISO pin	Output	PE13 pin: Slave data output line, used in push-pull pull-down mode
	SP4_SCK pin	Input	PE12 pin: Slave clock line, used in push-pull pull-down mode
	SPI4_NSS pin	Input	PE11 pin: slave chip select pin used in push-pull pull-up mode.
DFU bootloader	USB	Enabled	USB OTG FS configured in forced device mode.
	USB_DM pin	Input/Output	PA11 pin: USB DM line.
	USB_DP pin		PA12 pin: USB DP line No external Pull-Up resistor is required.
CAN2 and DFU bootloaders	TIM11	Enabled	This timer is used to determine the value of the HSE. Once HSE frequency is determined, the system clock is configured to 60 MHz using PLL and HSE.

The system clock is derived from the embedded internal high-speed RC for USARTx, I2Cx and SPIx bootloaders. This internal clock is also used for CAN and DFU (USB FS Device) but only for the selection phase. An external clock multiple of 1 MHz (between 4 and 26 MHz) is required for CAN and DFU bootloader execution after the selection phase.

37.2.2 Bootloader selection

The *Figure 45* shows the bootloader selection mechanism.

Figure 45.Bootloader V9.x selection for STM32F74xxx/75xxx

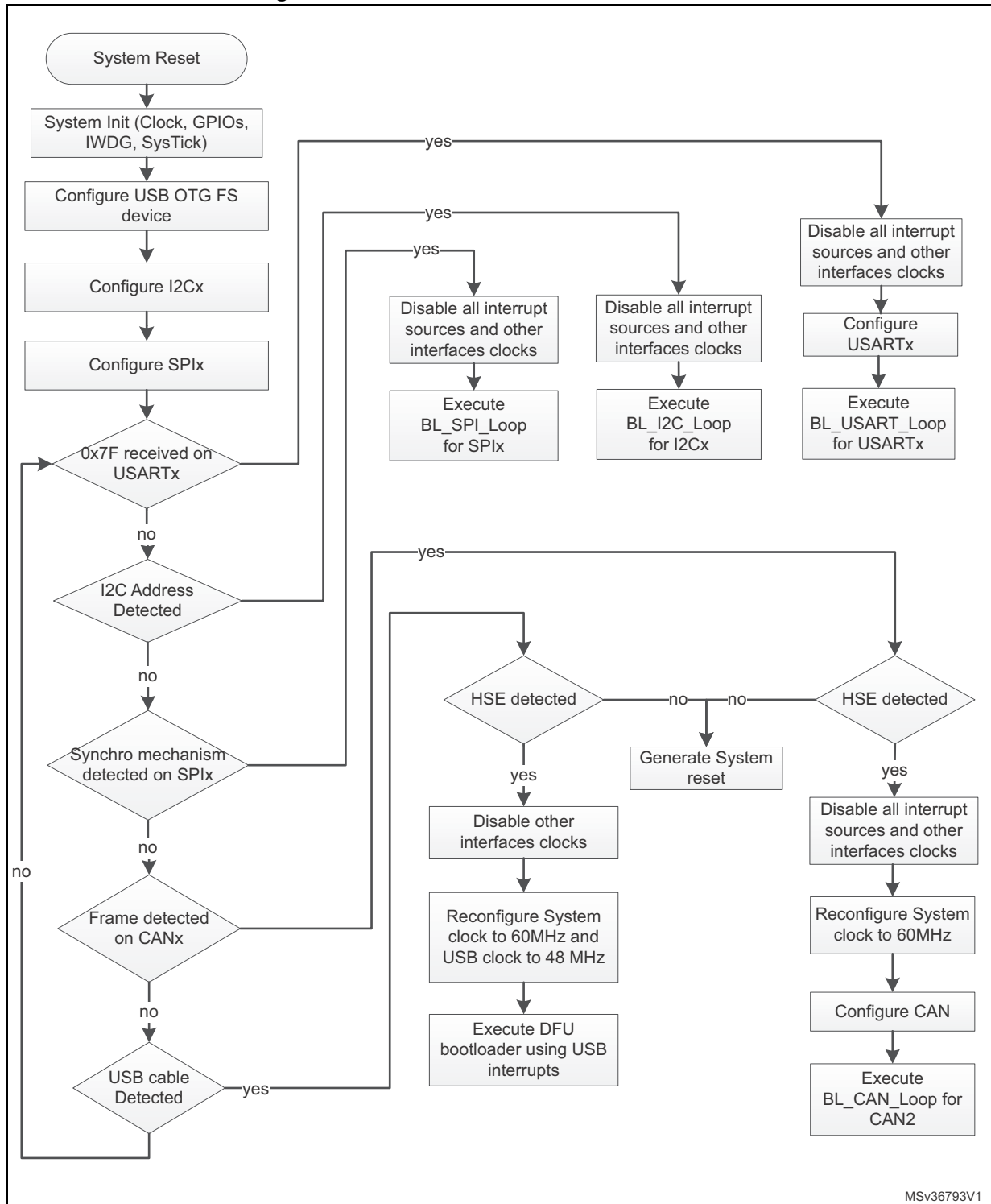

37.2.3 Bootloader version

The following table lists the STM32F74xxx/75xxx bootloader V9.x versions:

Table 79. STM32F74xxx/75xxx bootloader V9.x versions

Bootloader version number	Description	Known limitations
V9.0	Initial bootloader version	None

38 STM32F76xxx/77xxx devices bootloader

38.1 Bootloader configuration

The STM32F76xxx/77xxx bootloader is activated by applying pattern9 (described in [Table 2: Bootloader activation patterns](#)). The following table shows the hardware resources used by this bootloader.

Table 80. STM32F76xxx/77xxx configuration in system memory boot mode

Bootloader	Feature/Peripheral	State	Comment
Common to all bootloaders	RCC	HSI enabled	The HSI is used at startup as clock source for system clock configured to 60 MHz and for USART and I2C bootloader operation.
		HSE enabled	The HSE is used only when the CAN or the DFU (USB FS Device) interfaces are selected. In this case the system clock configured to 60 MHz with HSE as clock source. The HSE frequency must be multiple of 1 MHz and ranging from 4 MHz to 26 MHz.
		-	The Clock Security System (CSS) interrupt is enabled for the CAN and DFU bootloaders. Any failure (or removal) of the external clock generates system reset.
	RAM	-	16 Kbyte starting from address 0x20000000 are used by the bootloader firmware
	System memory	-	59 Kbyte starting from address 0x1FF00000, contain the bootloader firmware
	IWDG	-	The independent watchdog (IWDG) prescaler is configured to its maximum value. It is periodically refreshed to prevent watchdog reset (in case the hardware IWDG option was previously enabled by the user).
	Power	-	The voltage range is [1.8V, 3.6V] In this range: - Flash wait states 3. - System clock Frequency 60 MHz. - ART Accelerator enabled. - Flash write operation by byte (refer to bootloader memory management section for more information).

Table 80. STM32F76xxx/77xxx configuration in system memory boot mode (continued)

Bootloader	Feature/Peripheral	State	Comment
USART1 bootloader	USART1	Enabled	Once initialized the USART1 configuration is: 8-bits, even parity and 1 Stop bit
	USART1_RX pin	Input	PA10 pin: USART1 in reception mode
	USART1_TX pin	Output	PA9 pin: USART1 in transmission mode
USART3 bootloader (on PB11/PB10)	USART3	Enabled	Once initialized the USART3 configuration is: 8-bits, even parity and 1 Stop bit
	USART3_RX pin	Input	PB11 pin: USART3 in reception mode
	USART3_TX pin	Output	PB10 pin: USART3 in transmission mode
USART3 bootloader (on PC11/PC10)	USART3	Enabled	Once initialized the USART3 configuration is: 8-bits, even parity and 1 Stop bit
	USART3_RX pin	Input	PC11 pin: USART3 in reception mode
	USART3_TX pin	Output	PC10 pin: USART3 in transmission mode
USARTx bootloaders	SysTick timer	Enabled	Used to automatically detect the serial baud rate from the host for USARTx bootloaders.
CAN2 bootloader	CAN2	Enabled	Once initialized the CAN2 configuration is: Baudrate 125 kbps, 11-bit identifier. Note: CAN1 is clocked during CAN2 bootloader execution because CAN1 manages the communication between CAN2 and SRAM.
	CAN2_RX pin	Input	PB5 pin: CAN2 in reception mode
	CAN2_TX pin	Output	PB13 pin: CAN2 in transmission mode
I2C1 bootloader	I2C1	Enabled	The I2C1 configuration is: I2C speed: up to 400 KHz, 7-bit address, slave mode, analog filter ON. Slave 7-bit address: 0b1001001x (where x = 0 for write and x = 1 for read)
	I2C1_SCL pin	Input/Output	PB6 pin: clock line is used in open-drain mode.
	I2C1_SDA pin	Input/Output	PB9 pin: data line is used in open-drain mode.
I2C2 bootloader	I2C2	Enabled	The I2C2 configuration is: I2C speed: up to 400 KHz, 7-bit address, slave mode, analog filter ON. Slave 7-bit address: 0b1001001x (where x = 0 for write and x = 1 for read)
	I2C2_SCL pin	Input/Output	PF1 pin: clock line is used in open-drain mode.
	I2C2_SDA pin	Input/Output	PF0 pin: data line is used in open-drain mode.

Table 80. STM32F76xxx/77xxx configuration in system memory boot mode (continued)

Bootloader	Feature/Peripheral	State	Comment
I2C3 bootloader	I2C3	Enabled	The I2C3 configuration is: I2C speed: up to 400 KHz, 7-bit address, slave mode, analog filter ON. Slave 7-bit address: 0b1001001x (where x = 0 for write and x = 1 for read)
	I2C3_SCL pin	Input/Output	PA8 pin: clock line is used in open-drain mode.
	I2C3_SDA pin	Input/Output	PC9 pin: data line is used in open-drain mode.
SPI1 bootloader	SPI1	Enabled	The SPI1 configuration is: Slave mode, Full Duplex, 8-bit MSB, Speed up to 8MHz, Polarity: CPOL Low, CPHA Low, NSS hardware.
	SPI1_MOSI pin	Input	PA7 pin: Slave data Input line, used in push-pull pull-down mode
	SPI1_MISO pin	Output	PA6 pin: Slave data output line, used in push-pull pull-down mode
	SPI1_SCK pin	Input	PA5 pin: Slave clock line, used in push-pull pull-down mode
	SPI1_NSS pin	Input	PA4 pin: slave chip select pin used in push-pull pull-up mode.
SPI2 bootloader	SPI2	Enabled	The SPI2 configuration is: Slave mode, Full Duplex, 8-bit MSB, Speed up to 8MHz, Polarity: CPOL Low, CPHA Low, NSS hardware.
	SPI2_MOSI pin	Input	PI3 pin: Slave data Input line, used in push-pull pull-down mode
	SPI2_MISO pin	Output	PI2 pin: Slave data output line, used in push-pull pull-down mode
	SPI2_SCK pin	Input	PI1 pin: Slave clock line, used in push-pull pull-down mode
	SPI2_NSS pin	Input	PI0 pin: slave chip select pin used in push-pull pull-up mode.

Table 80. STM32F76xxx/77xxx configuration in system memory boot mode (continued)

Bootloader	Feature/Peripheral	State	Comment
SPI4 bootloader	SPI4	Enabled	The SPI4 configuration is: Slave mode, Full Duplex, 8-bit MSB, Speed up to 8MHz, Polarity: CPOL Low, CPHA Low, NSS hardware.
	SPI4_MOSI pin	Input	PE14 pin: Slave data Input line, used in push-pull pull-down mode
	SPI4_MISO pin	Output	PE13 pin: Slave data output line, used in push-pull pull-down mode
	SP4_SCK pin	Input	PE12 pin: Slave clock line, used in push-pull pull-down mode
	SPI4_NSS pin	Input	PE11 pin: slave chip select pin used in push-pull pull-up mode.
DFU bootloader	USB	Enabled	USB OTG FS configured in forced device mode
	USB_DM pin	Input/Output	PA11 pin: USB DM line.
	USB_DP pin		PA12 pin: USB DP line No external Pull-Up resistor is required.
CAN2 and DFU bootloaders	TIM11	Enabled	This timer is used to determine the value of the HSE. Once HSE frequency is determined, the system clock is configured to 60 MHz using PLL and HSE.

The system clock is derived from the embedded internal high-speed RC for USARTx and I2Cx bootloaders. This internal clock is also used for CAN and DFU (USB FS Device) but only for the selection phase. An external clock multiple of 1 MHz (between 4 and 26 MHz) is required for CAN and DFU bootloader execution after the selection phase.

38.2 Bootloader selection

The [Figure 46](#) and [Figure 47](#) show the bootloader selection mechanism.

Figure 46. Dual Bank Boot Implementation for STM32F76xxx/77xxx Bootloader V9.x

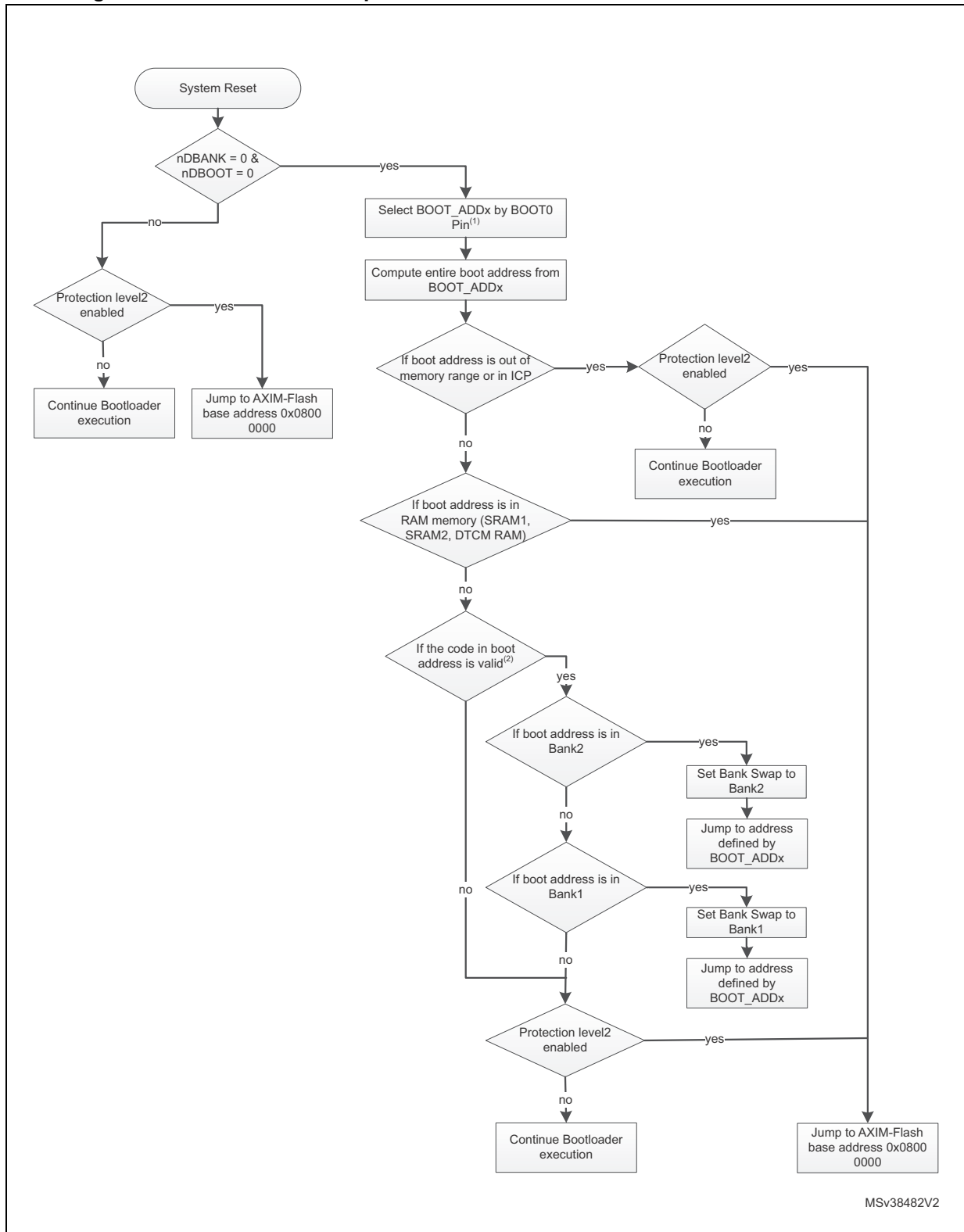

1. Only BOOT_ADD0 value is considered whatever the BOOT0 pin state, as described in Known limitation under [Table 81](#).
2. ITCM RAM is not considered valid as stack pointer address for the dual bank boot mechanism.

Figure 47. Bootloader V9.x selection for STM32F76xxx/77xxx

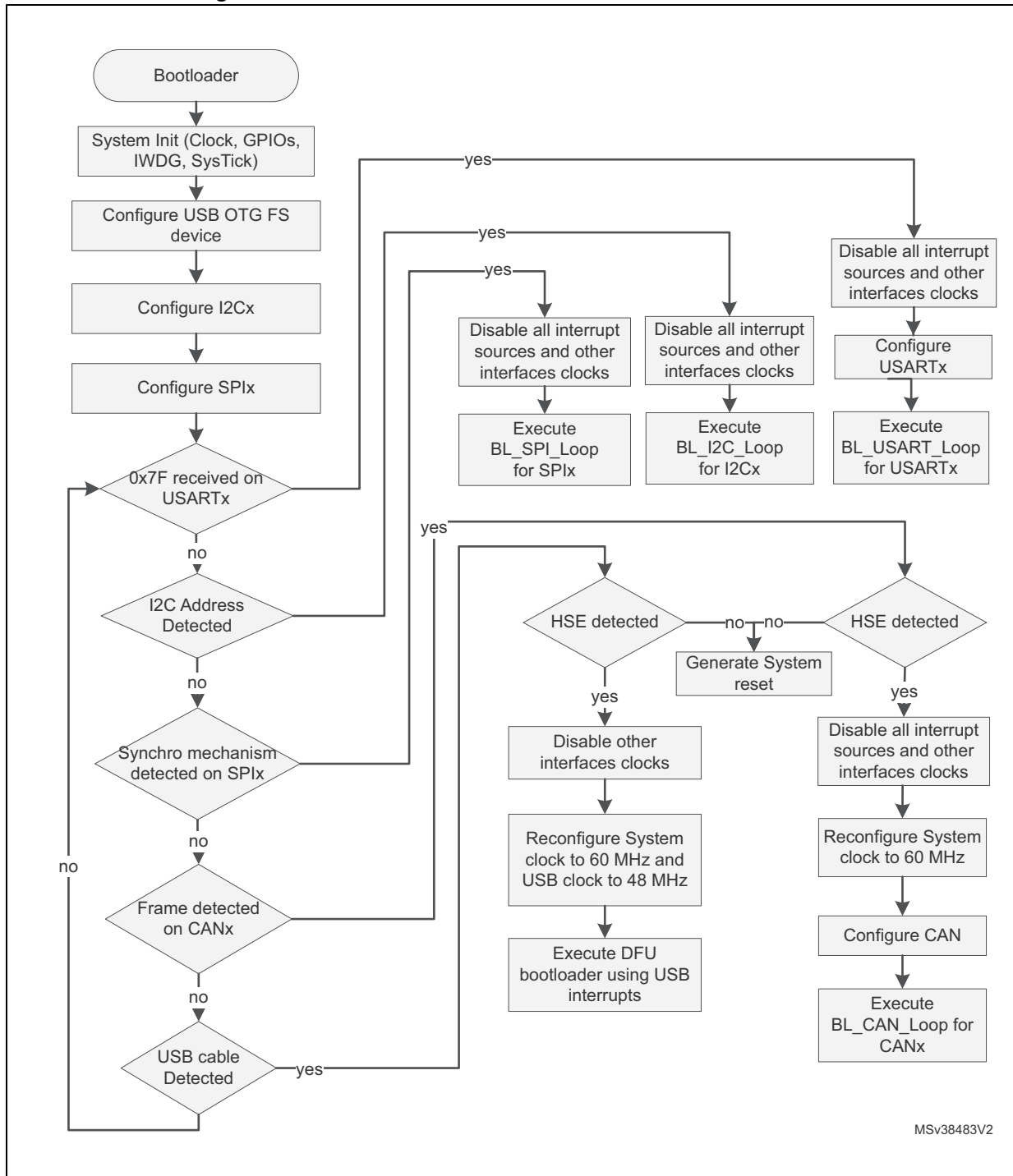

MSv38483V2

38.3 Bootloader version

The following table lists the STM32F76xxx/77xxx devices bootloader V9.x versions.

Table 81. STM32F76xxx/77xxx bootloader V9.x versions

Bootloader version number	Description	Known limitations
V9.3	Initial bootloader version	<p>When the Flash memory is configured to the dual bank boot mode (nDBANK=nDBOOT=0), whatever the BOOT0 Pin state only BOOT_ADD0 value is considered (when BOOT0 Pin=1, BOOT_ADD0 value is considered not the BOOT_ADD1).</p> <p>Workaround: in order to manage dual bank boot with BOOT_ADD0 only, please refer to the AN4826: "STM32F7 Series Flash memory dual bank mode"</p>

39 STM32G03xxx/ STM32G04xxx devices bootloader

39.1 Bootloader configuration

The STM32G03xxx/G04xxx bootloader is activated by applying pattern11 (described in [Table 2: Bootloader activation patterns](#)). The following table shows the hardware resources used by this bootloader.

Table 82. STM32G03xxx/G04xxx configuration in system memory boot mode

Bootloader	Feature/Peripheral	State	Comment
Common to all bootloaders	RCC	HSI enabled	The system clock frequency is 24 MHz (using PLL clocked by HSI).
	RAM	-	4 Kbytes starting from address 0x20000000 are used by the bootloader firmware
	System memory	-	8 Kbytes starting from address 0x1FFF0000
	IWDG	-	The independent watchdog (IWDG) prescaler is configured to its maximum value. It is periodically refreshed to prevent watchdog reset (in case the hardware IWDG option was previously enabled by the user).
Securable memory area	-	-	The Address to jump to for the securable memory area: @0x1FFF1D00
USART1 bootloader	USART1	Enabled	Once initialized the USART1 configuration is: 8-bits, even parity and 1 Stop bit
	USART1_RX pin	Input	PA10 pin: USART1 in reception mode
	USART1_TX pin	Output	PA9 pin: USART1 in transmission mode
USART2 bootloader	USART2	Enabled	Once initialized the USART2 configuration is: 8-bits, even parity and 1 Stop bit
	USART2_RX pin	Input	PA3 pin: USART2 in reception mode
	USART2_TX pin	Output	PA2 pin: USART2 in transmission mode
USARTx bootloader	SysTick timer	Enabled	Used to automatically detect the serial baud rate from the host for USARTx bootloaders.
I2C1 bootloader	I2C1	Enabled	The I2C1 configuration is: I2C speed: up to 1 MHz, 7-bit address, slave mode, analog filter ON. Slave 7-bit address: 0b1010001x (where x = 0 for write and x = 1 for read)
	I2C1_SCL pin	Input/Output	PC4 pin: clock line is used in open-drain mode.
	I2C1_SDA pin	Input/Output	PA8 pin: data line is used in open-drain mode.

Table 82. STM32G03xxx/G04xxx configuration in system memory boot mode (continued)

Bootloader	Feature/Peripheral	State	Comment
I2C2 bootloader	I2C2	Enabled	The I2C2 configuration is: I2C speed: up to 1 MHz, 7-bit address, slave mode, analog filter ON. Slave 7-bit address: 0b1010001x (where x = 0 for write and x = 1 for read)
	I2C2_SCL pin	Input/Output	PC6 pin: clock line is used in open-drain mode.
	I2C2_SDA pin	Input/Output	PC7 pin: data line is used in open-drain mode.

The sticky area is used to isolate boot code/data which manipulate sensitive information (secrets) from application code:

- Access is controlled by a sticky bit STICKY_PROT (write once), in the Flash memory CR register;
- Executed once at boot then locked by writing the sticky bit;
- Width (number of Flash memory pages) is defined through an OB, STICKY_SIZE, in the Flash memory STICKYR register;

The chain of trust is seeded by a unique boot entry via an additional option byte, the BOOT_EP option byte in the Flash memory STICKYR register.

The BOOT_EP forces boot from user Flash memory, regardless from boot configuration and RDP level.

Note: For more information regarding the STM32G03xxx/ STM32G04xxx option bytes configuration, refer to the STM32G0 reference manual.

[Figure 48](#) shows the flow to access to securable memory area from the bootloader.

Figure 48. Access to securable memory area from the bootloader for STM32G03xxx/G04xxx

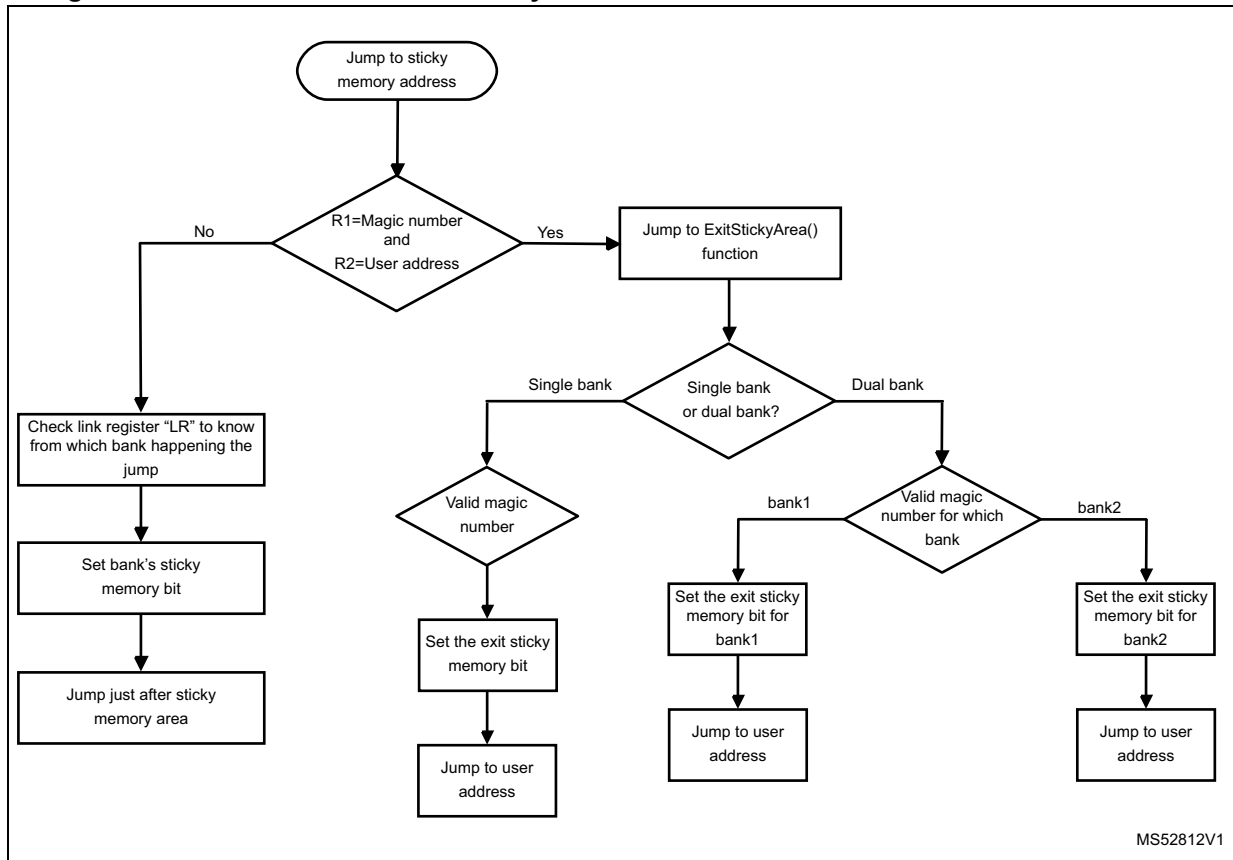

Note: The bootloader doesn't check on the integrity of the user address, it's up to the user to ensure the validity of the address to jump to.

39.2 Bootloader selection

Figure 49 shows the bootloader selection mechanism.

Figure 49. Bootloader V5.x selection for STM32G03xxx/G04xxx

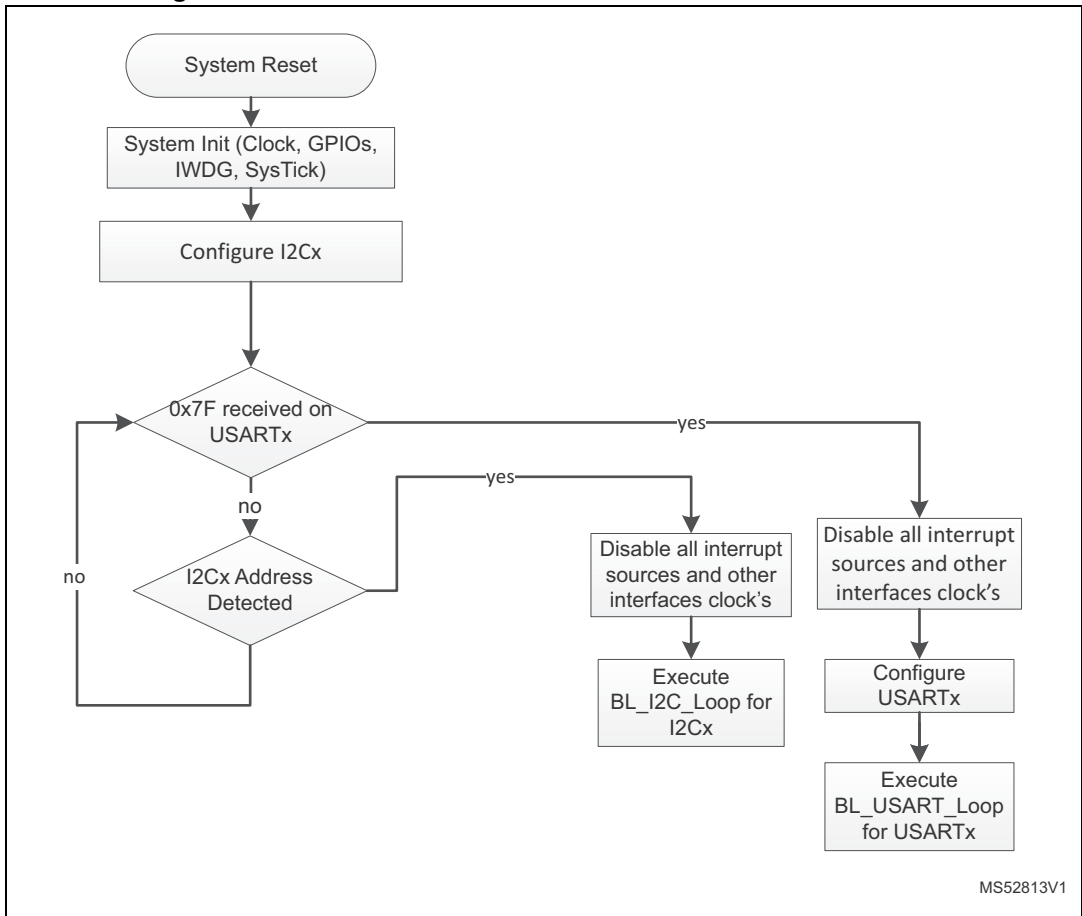

39.3 Bootloader version

Table 83 lists the STM32G03xxx/G4xxx devices bootloader versions.

Table 83. STM32G03xx/04xxx bootloader versions

Bootloader version number	Description	Known limitations
V5.1	Initial bootloader version	<ul style="list-style-type: none"> – Supporting only 48 and 32 pins packages – Issue is seen in both packages, if PA3 stay to low level, system will stay stuck in the USART2 detection sequence and no other interface will be detected.

Table 83. STM32G03xx/04xxx bootloader versions

Bootloader version number	Description	Known limitations
V5.2	Add support to small packages 8/20 and 28 pins	Issue is seen in all packages (except SO8, no PA3 pin) if PA3 stay to low level, system will stay stuck in the USART2 detection sequence and no other interface will be detected.
V5.3	Fix V5.2 limitations	None

40 STM32G07xxx/08xxx device bootloader

40.1 Bootloader configuration

The STM32G07xxx/G08xxx bootloader is activated by applying pattern11 (described in [Table 2: Bootloader activation patterns](#)). The following table shows the hardware resources used by this bootloader.

Table 84. STM32G07xxx/8xxx configuration in system memory boot mode

Bootloader	Feature/Peripheral	State	Comment
Common to all bootloaders	RCC	HSI enabled	The system clock frequency is 24 MHz (using PLL clocked by HSI).
	RAM	-	12 Kbytes starting from address 0x20000000 are used by the bootloader firmware
	System memory	-	28 Kbytes starting from address 0x1FFF0000, contain the bootloader firmware
	IWDG	-	The independent watchdog (IWDG) prescaler is configured to its maximum value. It is periodically refreshed to prevent watchdog reset (in case the hardware IWDG option was previously enabled by the user).
Securable memory area	-	-	The Address to jump to for the securable memory area: @0x1FFF6800
USART1 bootloader	USART1	Enabled	Once initialized the USART1 configuration is: 8-bits, even parity and 1 Stop bit
	USART1_RX pin	Input	PA10 pin: USART1 in reception mode
	USART1_TX pin	Output	PA9 pin: USART1 in transmission mode
USART2 bootloader	USART2	Enabled	Once initialized the USART2 configuration is: 8-bits, even parity and 1 Stop bit
	USART2_RX pin	Input	PA3 pin: USART2 in reception mode
	USART2_TX pin	Output	PA2 pin: USART2 in transmission mode
USART3 bootloader	USART3	Enabled	Once initialized the USART3 configuration is: 8-bits, even parity and 1 Stop bit
	USART3_RX pin	Input	PC11 pin: USART3 in reception mode
	USART3_TX pin	Output	PC10 pin: USART3 in transmission mode
I2C1 bootloader	I2C1	Enabled	The I2C1 configuration is: I2C speed: up to 1 MHz, 7-bit address, slave mode, analog filter ON. Slave 7-bit address: 0b1010001x (where x = 0 for write and x = 1 for read)
	I2C1_SCL pin	Input/Output	PB6 pin: clock line is used in open-drain mode.
	I2C1_SDA pin	Input/Output	PB7 pin: data line is used in open-drain mode.

Table 84. STM32G07xxx/8xxx configuration in system memory boot mode (continued)

Bootloader	Feature/Peripheral	State	Comment
I2C2 bootloader	I2C2	Enabled	The I2C2 configuration is: I2C speed: up to 1 MHz, 7-bit address, slave mode, analog filter ON. Slave 7-bit address: 0b1010001x (where x = 0 for write and x = 1 for read)
	I2C2_SCL pin	Input/Output	PB10 pin: clock line is used in open-drain mode.
	I2C2_SDA pin	Input/Output	PB11 pin: data line is used in open-drain mode.
SPI1 bootloader	SPI1	Enabled	The SPI1 configuration is: – Slave mode – Full Duplex – 8-bit MSB – Speed up to 8 MHz – Polarity: CPOL Low, CPHA Low, NSS hardware.
	SPI1_MOSI pin	Input	PA7 pin: Slave data Input line, used in push-pull, pull-down mode.
	SPI1_MISO pin	Output	PA6 pin: Slave data output line, used in push-pull, pull-down mode.
	SPI1_SCK pin	Input	PA5 pin: Slave clock line, used in push-pull, pull-down mode.
	SPI1_NSS pin	Input	PA4 pin: slave chip select pin used in push-pull, pull-up mode. Note: This IO can be tied to Gnd if the SPI Master does not use it.
SPI2 bootloader	SPI2	Enabled	The SPI2 configuration is: – Slave mode – Full Duplex – 8-bit MSB – Speed up to 8 MHz – Polarity: CPOL Low, CPHA Low, NSS hardware.
	SPI2_MOSI pin	Input	PB15 pin: Slave data Input line, used in push-pull, pull-down mode.
	SPI2_MISO pin	Output	PB14 pin: Slave data output line, used in push-pull, pull-down mode.
	SPI2_SCK pin	Input	PB13 pin: Slave clock line, used in push-pull, pull-down mode.
	SPI2_NSS pin	Input	PB12 pin: slave chip select pin used in push-pull, pull-up. Note: This IO can be tied to GND if the SPI master does not use it.

The securable memory area is used to isolate boot code/data which manipulate sensitive information (secrets) from application code:

- Access is controlled by a sticky bit SEC_PROT (write once), in the flash CR register;
- Executed once at boot then locked by writing the sticky bit;
- Width (number of FLASH pages) is defined through an OB, SEC_SIZE, in the flash SEC_R register;

The chain of trust is seeded by a unique boot entry via an additional option byte, the BOOT_EP option byte in the flash SEC_R register.

The BOOT_EP forces boot from user flash, regardless from boot configuration and RDP level.

Note: For more information regarding the STM32G0xxx option bytes configuration, refer to the STM32G0 reference manual

Figure 50 shows the flow to access to securable memory area from the bootloader.

Figure 50. Access to securable memory area from the bootloader for STM32G07xxx/G08xxx

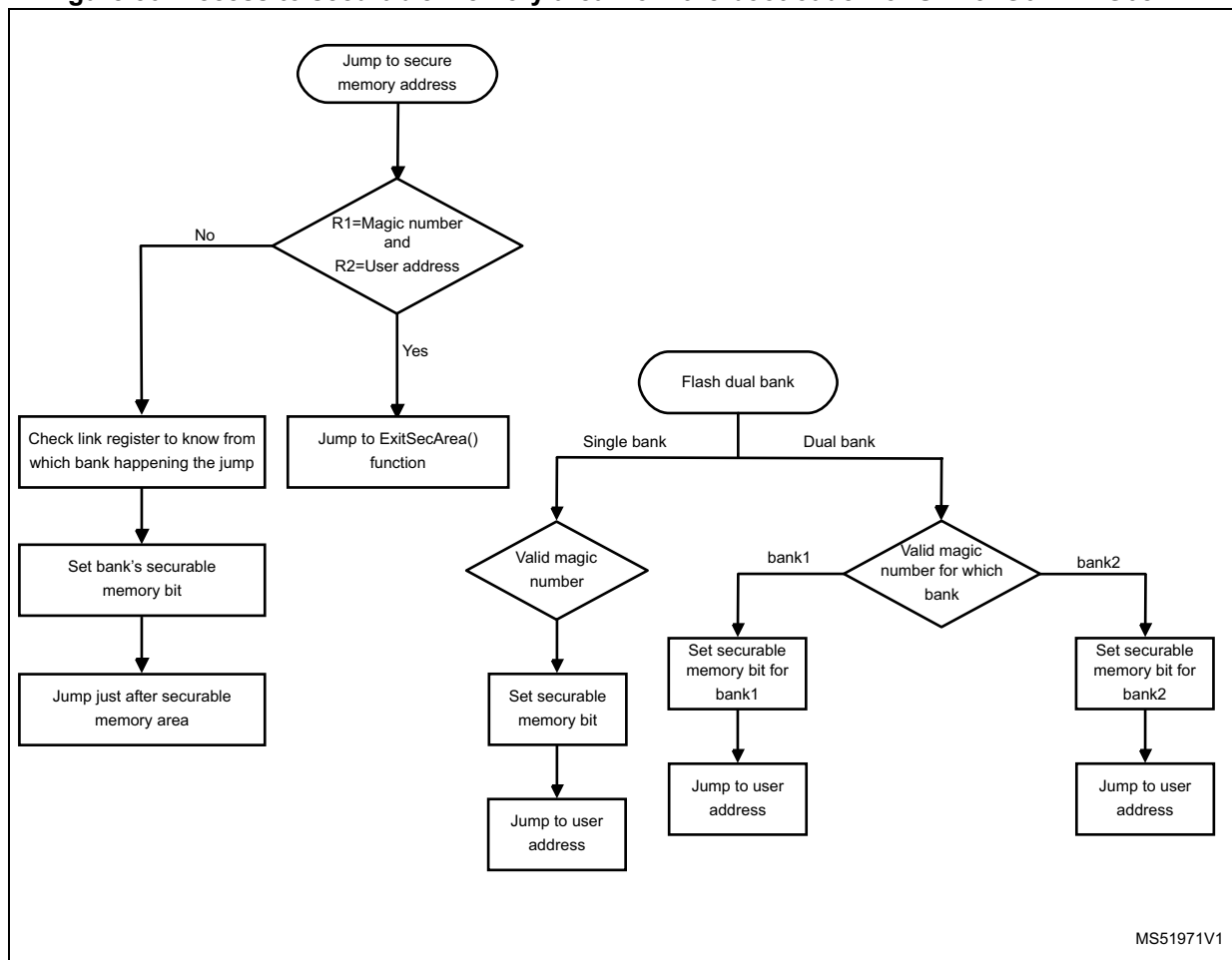

1. The Bootloader doesn't check on the integrity of the user address, it's up to the user to ensure the validity of the address to jump to.

40.2 Bootloader selection

Figure 51 shows the bootloader selection mechanism.

Figure 51. Bootloader V11.0 selection for STM32G07xxx/G08xxx

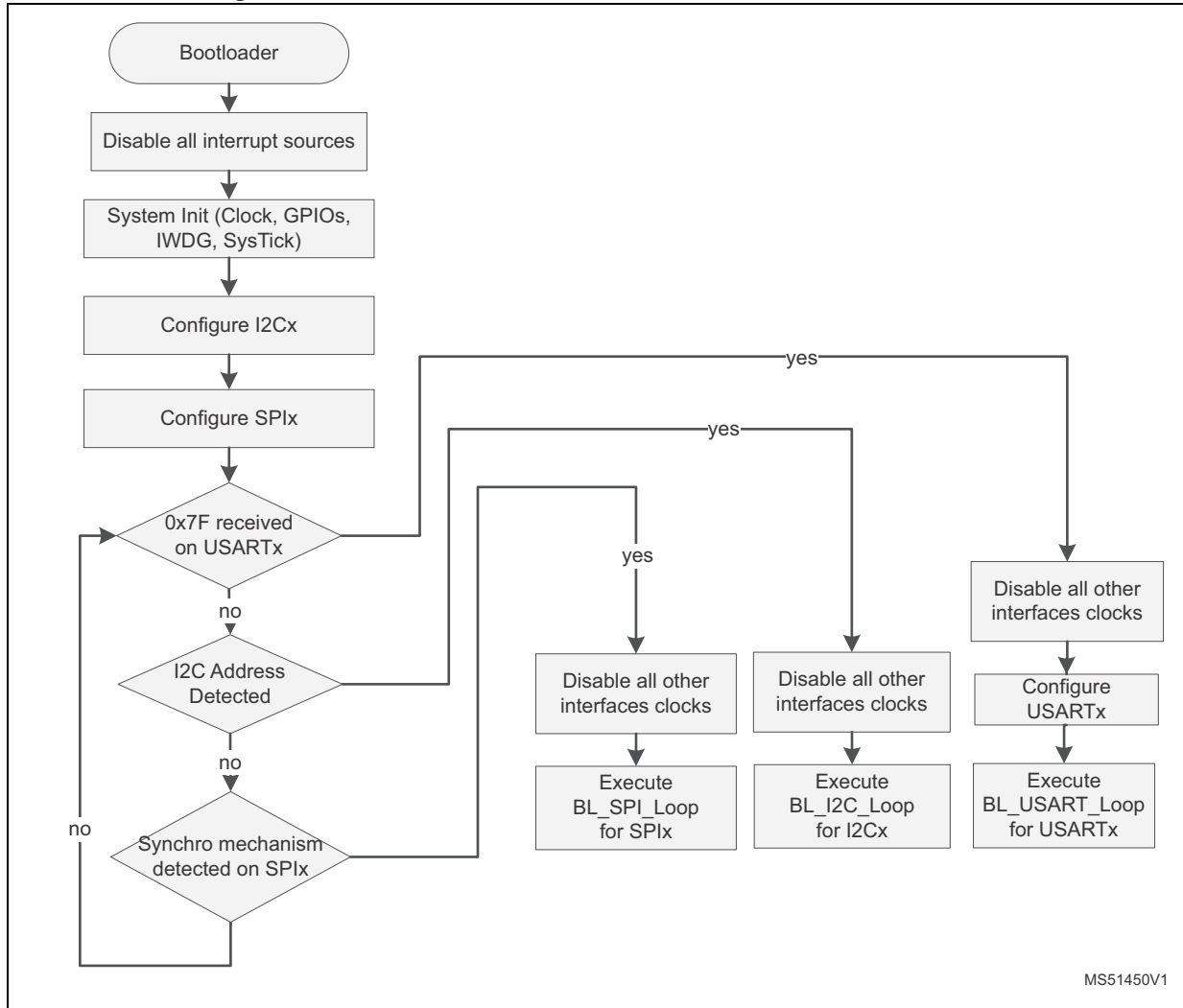

MS51450V1

40.3 Bootloader version

Table 85 lists the STM32G07xxx/8xxx devices bootloader versions.

Table 85. STM32G07xx/08xxx bootloader versions

Bootloader version number	Description	Known limitations
V11.0	Initial bootloader version	Not supporting packages smaller than LQFP64
V11.1	Supporting all packages	None
V11.2	Add securable memory area feature	None

41 STM32G431xx/441xx devices bootloader

41.1 Bootloader configuration

The STM32G431xx/441xx bootloader is activated by applying pattern6 (described in [Table 2: Bootloader activation patterns](#)). The following table shows the hardware resources used by this bootloader.

Table 86. STM32G431xx/441xx configuration in system memory boot mode

Bootloader	Feature/Peripheral	State	Comment
Common to all bootloaders	RCC	HSI enabled	The system clock frequency is 72 MHz (using the PLL clocked by HSI)
		-	The clock recovery system (CRS) is enabled for the DFU bootloader to allow USB to be clocked by HSI48 48 MHz
	RAM	-	16 Kbyte starting from address 0x20000000 are used by the bootloader firmware
	System memory	-	28 Kbyte starting from address 0x1FFF0000, contain the bootloader firmware
	IWDG	-	The independent watchdog (IWDG) prescaler is configured to its maximum value. It is periodically refreshed to prevent watchdog reset (in case the hardware IWDG option was previously enabled by the user).
Securable memory area	-	-	The address to jump to the exit securable memory area @0x1FFF6800
USART1 bootloader	USART1	Enabled	Once initialized the USART1 configuration is: 8-bits, even parity and 1 Stop bit
	USART1_RX pin	Input	PA10 pin: USART1 in reception mode
	USART1_TX pin	Output	PA9 pin: USART1 in transmission mode
USART2 bootloader	USART2	Enabled	Once initialized the USART2 configuration is: 8-bits, even parity and 1 Stop bit
	USART2_RX pin	Input	PA3 pin: USART2 in reception mode
	USART2_TX pin	Output	PA2 pin: USART2 in transmission mode
USART3 bootloader	USART3	Enabled	Once initialized the USART3 configuration is: 8-bits, even parity and 1 Stop bit
	USART3_RX pin	Input	PC11 pin: USART3 in reception mode
	USART3_TX pin	Output	PC10 pin: USART3 in transmission mode

Table 86. STM32G431xx/441xx configuration in system memory boot mode (continued)

Bootloader	Feature/Peripheral	State	Comment
I2C2 bootloader	I2C2	Enabled	The I2C2 configuration is: I2C speed: up to 1 MHz, 7-bit address, slave mode, analog filter ON. Slave 7-bit address: 0b1010100x (where x = 0 for write and x = 1 for read)
	I2C2_SCL pin	Input/Output	PC4 pin: clock line is used in open-drain mode.
	I2C2_SDA pin	Input/Output	PA8 pin: data line is used in open-drain mode.
I2C3 bootloader	I2C3	Enabled	The I2C3 configuration is: I2C speed: up to 1 MHz, 7-bit address, slave mode, analog filter ON. Slave 7-bit address: 0b1010100x (where x = 0 for write and x = 1 for read)
	I2C3_SCL pin	Input/Output	PC6 pin: clock line is used in open-drain mode.
	I2C3_SDA pin	Input/Output	PC7 pin: data line is used in open-drain mode.
SPI1 bootloader	SPI1	Enabled	The SPI1 configuration is: – Slave mode – Full Duplex – 8-bit MSB – Speed up to 8 MHz – Polarity: CPOL Low, CPHA Low, NSS hardware.
	SPI1_MOSI pin	Input	PA7 pin: Slave data Input line, used in push-pull, no pull-up no pull-down mode.
	SPI1_MISO pin	Output	PA6 pin: Slave data output line, used in push-pull, no pull-up no pull-down mode.
	SPI1_SCK pin	Input	PA5 pin: Slave clock line, used in push-pull no pull-up, no pull-up no pull-down mode.
	SPI1_NSS pin	Input	PA4 pin: slave chip select pin used in push-pull, no pull-up no pull-down mode.

Table 86. STM32G431xx/441xx configuration in system memory boot mode (continued)

Bootloader	Feature/Peripheral	State	Comment
SPI2 bootloader	SPI2	Enabled	The SPI2 configuration is: – Slave mode – Full Duplex – 8-bit MSB – Speed up to 8 MHz – Polarity: CPOL Low, CPHA Low, NSS hardware.
	SPI2_MOSI pin	Input	PB15 pin: Slave data Input line, used in push-pull, no pull-up no pull-down mode.
	SPI2_MISO pin	Output	PB14 pin: Slave data output line, used in push-pull, no pull-up no pull-down mode.
	SPI2_SCK pin	Input	PB13 pin: Slave clock line, used in push-pull, no pull-up no pull-down mode.
	SPI2_NSS pin	Input	PB12 pin: slave chip select pin used in push-pull, no pull-up no pull-down mode. Note: This IO can be tied to GND if the SPI Master does not use it.
DFU bootloader	USB	Enabled	USB FS configured in forced device mode. USB FS interrupt vector is enabled and used for USB DFU communications. Note: VDDUSB IO must be connected to 3.3 V for USB to be operational.
	USB_DM pin	Input/Output	PA11: USB DM line.
	USB_DP pin		PA12: USB DP line No external Pull-up resistor is required

The securable memory area is used to isolate boot code/data which manipulate sensitive information (secrets) from application code:

- Access is controlled by a securable memory bit SEC_PROT (write once), in the Flash CR register;
- Executed once at boot then locked by writing the securable memory bit;
- Width (number of Flash memory pages) is defined through an OB, SEC_SIZE, in the Flash SEC_R register;

The chain of trust is seeded by a unique boot entry via an additional option byte, the BOOT_EP option byte in the Flash SEC_R register.

The BOOT_EP forces boot from user Flash memory, regardless from boot configuration and RDP level.

Note: For more information regarding the STM32G431xx/441xx option bytes configuration, refer to the STM32G4 reference manual (RM0440).

Next figure shows the flow to access to securable memory area from the bootloader.

Figure 52. Access to securable memory area

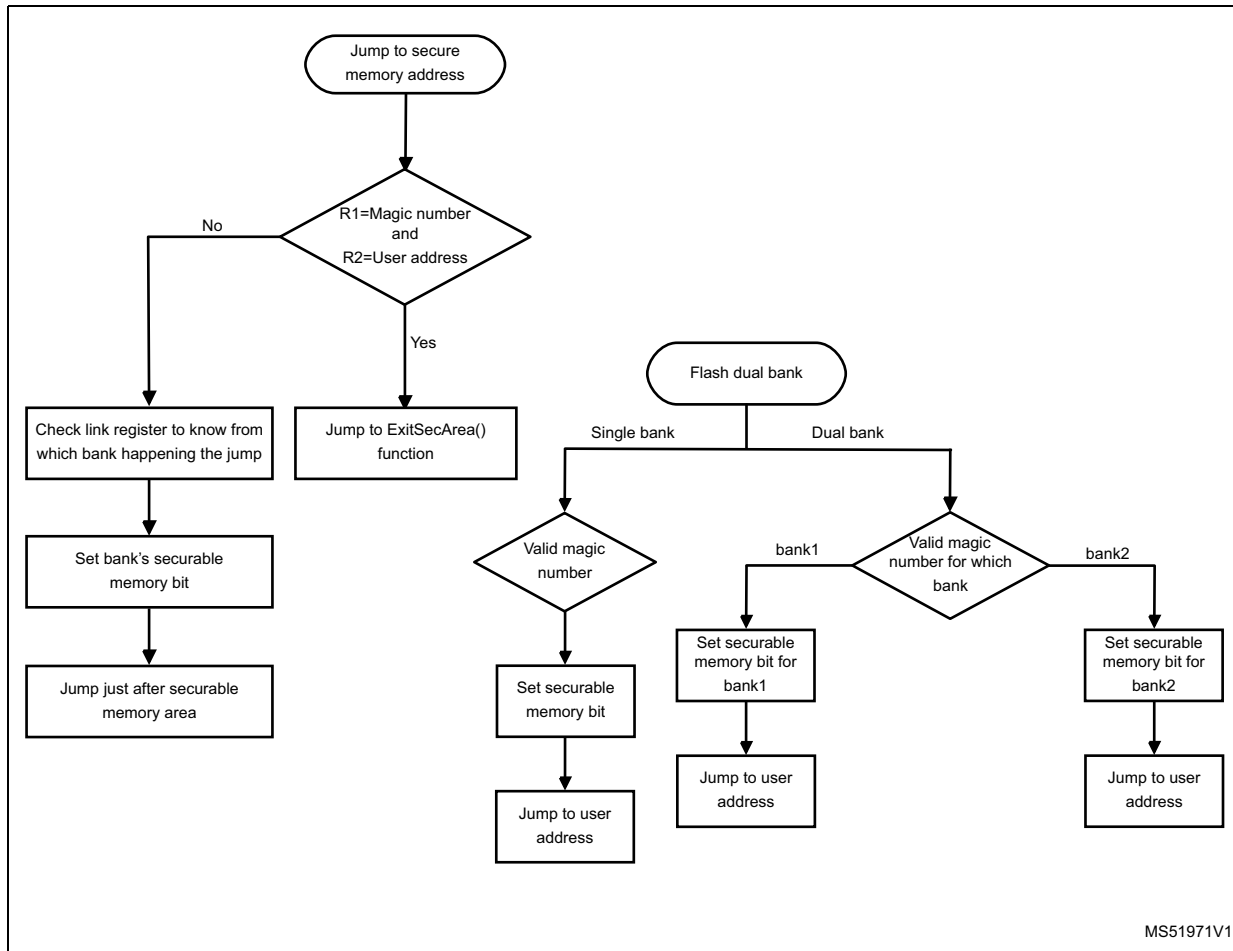

Note: *The bootloader does not check the integrity of the user address, but the user must ensure the validity of the address to jump to.*

41.2 Bootloader selection

The figure below shows the bootloader selection mechanism.

Figure 53. Bootloader selection for STM32G431xx/441xx

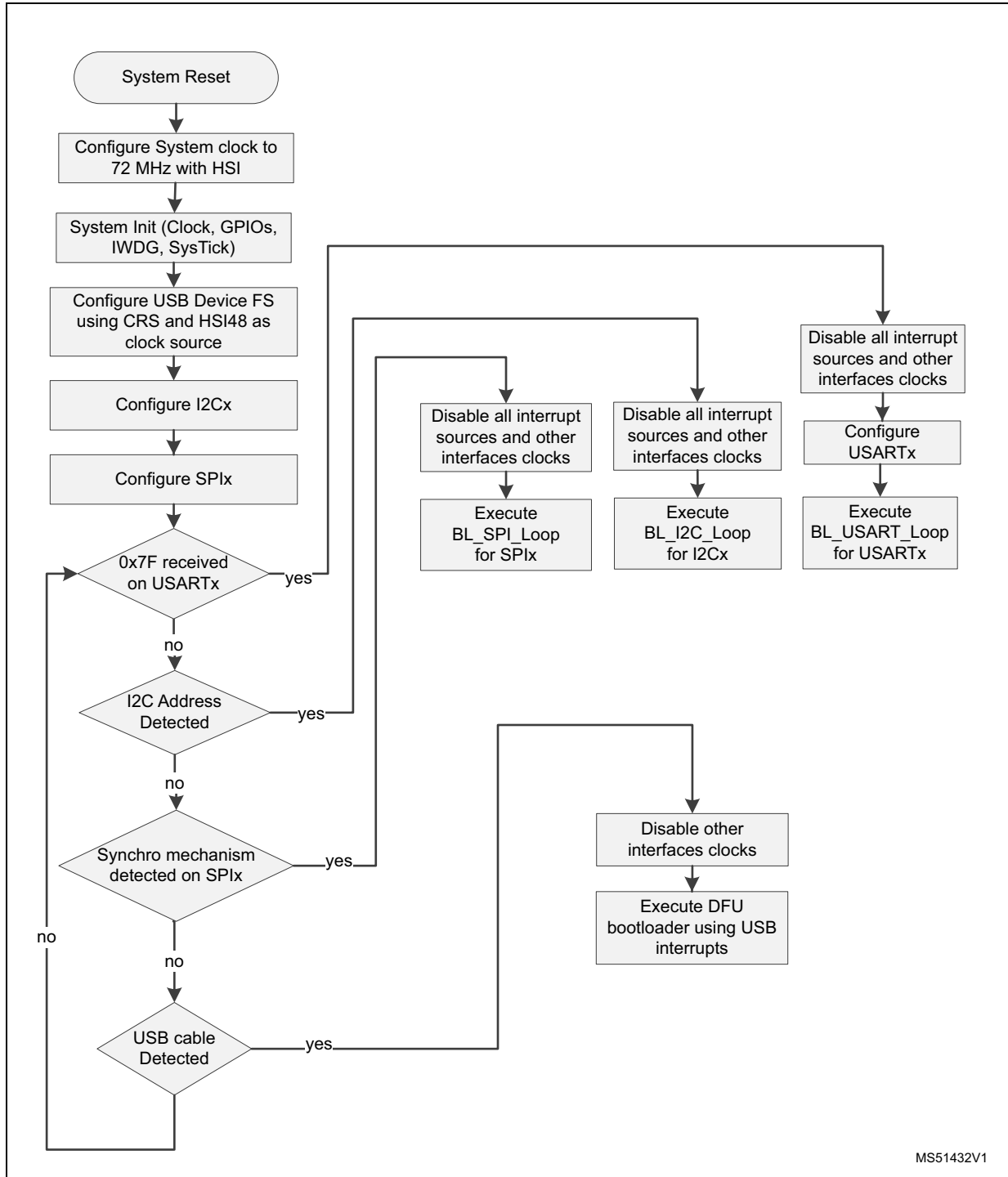

41.3 Bootloader version

Table 87. STM32G431xx/441xx bootloader version

Bootloader version number	Description	Known limitations
V13.3	Initial bootloader version	None

42 STM32G47xxx/48xxx devices bootloader

42.1 Bootloader Configuration

The STM32G47xxx/48xxx bootloader is activated by applying pattern5 (described in [Table 2: Bootloader activation patterns](#)). The following table shows the hardware resources used by this bootloader

Table 88. STM32G47xxx/48xxx configuration in system memory boot mode

Bootloader	Feature/Peripheral	State	Comment
Common to all bootloaders	RCC	HSI enabled	The system clock frequency is 72 MHz (using the PLL clocked by HSI)
		-	The clock recovery system (CRS) is enabled for the DFU bootloader to allow USB to be clocked by HSI48 48 MHz
	RAM	-	16 Kbyte starting from address 0x20000000 are used by the bootloader firmware
	System memory	-	28 Kbyte starting from address 0x1FFF0000, contain the bootloader firmware
	IWDG	-	The independent watchdog (IWDG) prescaler is configured to its maximum value. It is periodically refreshed to prevent watchdog reset (in case the hardware IWDG option was previously enabled by the user).
Securable memory area	-	-	The address to jump to the exit securable memory area @0x1FFF6800
USART1 bootloader	USART1	Enabled	Once initialized the USART1 configuration is: 8-bits, even parity and 1 Stop bit
	USART1_RX pin	Input	PA10 pin: USART1 in reception mode
	USART1_TX pin	Output	PA9 pin: USART1 in transmission mode
USART2 bootloader	USART2	Enabled	Once initialized the USART2 configuration is: 8-bits, even parity and 1 Stop bit
	USART2_RX pin	Input	PA3 pin: USART2 in reception mode
	USART2_TX pin	Output	PA2 pin: USART2 in transmission mode
USART3 bootloader	USART3	Enabled	Once initialized the USART3 configuration is: 8-bits, even parity and 1 Stop bit
	USART3_RX pin	Input	PC11 pin: USART3 in reception mode
	USART3_TX pin	Output	PC10 pin: USART3 in transmission mode

Table 88. STM32G47xxx/48xxx configuration in system memory boot mode (continued)

Bootloader	Feature/Peripheral	State	Comment
I2C2 bootloader	I2C2	Enabled	The I2C2 configuration is: I2C speed: up to 1 MHz, 7-bit address, slave mode, analog filter ON. Slave 7-bit address: 0b1010100x (where x = 0 for write and x = 1 for read)
	I2C2_SCL pin	Input/Output	PC4 pin: clock line is used in open-drain mode.
	I2C2_SDA pin	Input/Output	PA8 pin: data line is used in open-drain mode.
I2C3 bootloader	I2C3	Enabled	The I2C3 configuration is: I2C speed: up to 1 MHz, 7-bit address, slave mode, analog filter ON. Slave 7-bit address: 0b1010100x (where x = 0 for write and x = 1 for read)
	I2C3_SCL pin	Input/Output	PC6 pin: clock line is used in open-drain mode.
	I2C3_SDA pin	Input/Output	PC7 pin: data line is used in open-drain mode.
I2C4 bootloader	I2C4	Enabled	The I2C4 configuration is: I2C speed: up to 1 MHz, 7-bit address, slave mode, analog filter ON. Slave 7-bit address: 0b1010100x (where x = 0 for write and x = 1 for read)
	I2C4_SCL pin	Input/Output	PC8 pin: clock line is used in open-drain mode.
	I2C4_SDA pin	Input/Output	PC9 pin: data line is used in open-drain mode.
SPI1 bootloader	SPI1	Enabled	The SPI1 configuration is: – Slave mode – Full Duplex – 8-bit MSB – Speed up to 8 MHz – Polarity: CPOL Low, CPHA Low, NSS hardware.
	SPI1_MOSI pin	Input	PA7 pin: Slave data Input line, used in push-pull, no pull-up no pull-down mode.
	SPI1_MISO pin	Output	PA6 pin: Slave data output line, used in push-pull, no pull-up no pull-down mode.
	SPI1_SCK pin	Input	PA5 pin: Slave clock line, used in push-pull no pull-up, no pull-up no pull-down mode.
	SPI1_NSS pin	Input	PA4 pin: slave chip select pin used in push-pull, no pull-up no pull-down mode.

Table 88. STM32G47xxx/48xxx configuration in system memory boot mode (continued)

Bootloader	Feature/Peripheral	State	Comment
SPI2 bootloader	SPI2	Enabled	The SPI2 configuration is: – Slave mode – Full Duplex – 8-bit MSB – Speed up to 8 MHz – Polarity: CPOL Low, CPHA Low, NSS hardware.
	SPI2_MOSI pin	Input	PB15 pin: Slave data Input line, used in push-pull, no pull-up no pull-down mode.
	SPI2_MISO pin	Output	PB14 pin: Slave data output line, used in push-pull, no pull-up no pull-down mode.
	SPI2_SCK pin	Input	PB13 pin: Slave clock line, used in push-pull, no pull-up no pull-down mode.
	SPI2_NSS pin	Input	PB12 pin: slave chip select pin used in push-pull, no pull-up no pull-down mode. Note: This IO can be tied to GND if the SPI Master does not use it.
DFU bootloader	USB	Enabled	USB FS configured in forced device mode. USB FS interrupt vector is enabled and used for USB DFU communications. Note: VDDUSB IO must be connected to 3.3 V for USB to be operational.
	USB_DM pin	Input/Output	PA11: USB DM line.
	USB_DP pin		PA12: USB DP line No external Pull-up resistor is required

The securable memory area is used to isolate boot code/data which manipulate sensitive information (secrets) from application code:

- Access is controlled by a securable memory bit SEC_PROT (write once), in the Flash CR register;
- Executed once at boot then locked by writing the securable memory bit;
- Width (number of Flash memory pages) is defined through an OB, SEC_SIZE, in the Flash SEC_R register;

The chain of trust is seeded by a unique boot entry via an additional option byte, the BOOT_EP option byte in the Flash SEC_R register.

The BOOT_EP forces boot from user Flash memory, regardless from boot configuration and RDP level.

Note: For more information regarding the STM32G47xxx/48xxx option bytes configuration, refer to the RM0433 reference manual

Next figure shows the flow to access to securable memory area from the bootloader.

Figure 54. Access to securable memory area

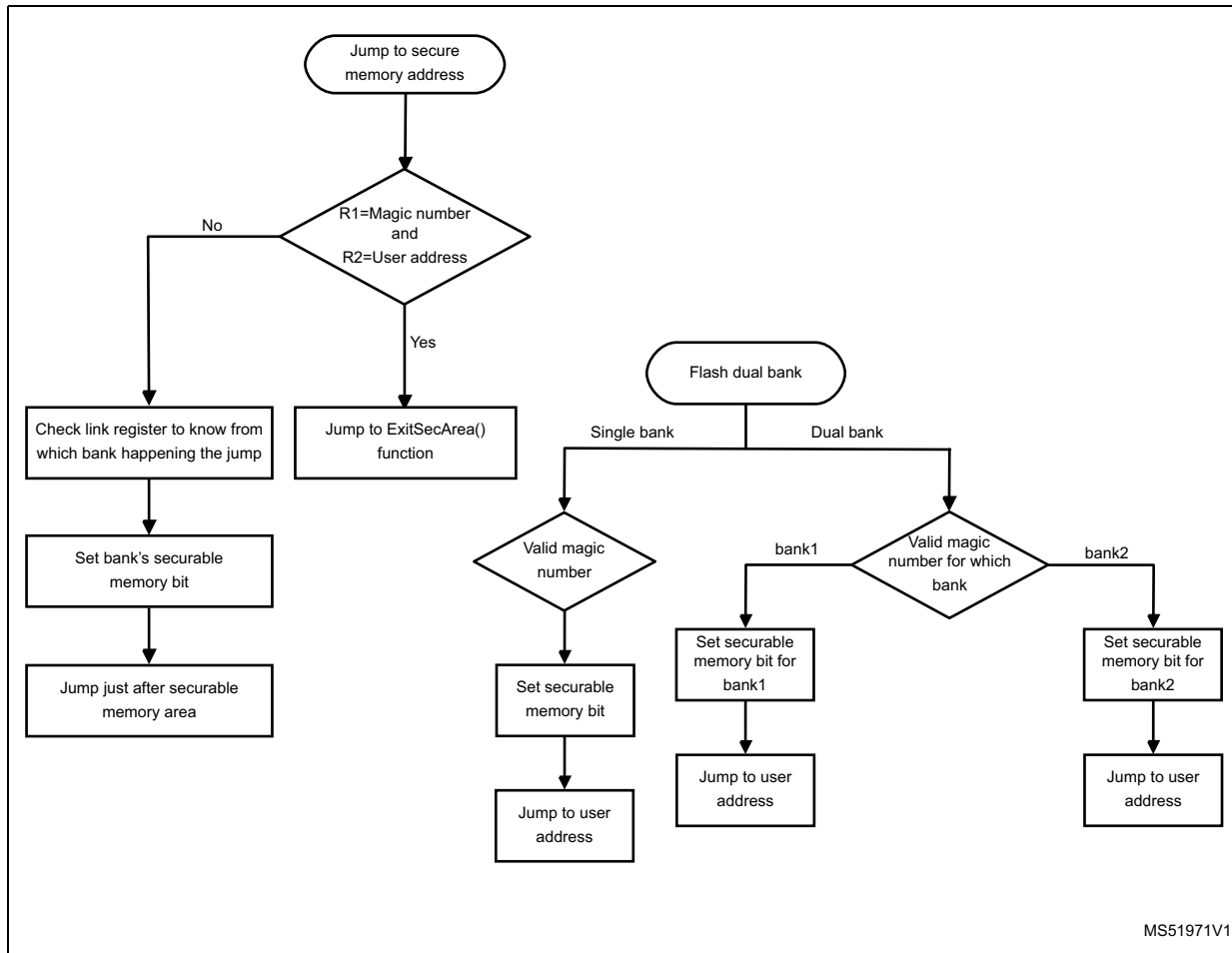

Note: *The bootloader does not check the integrity of the user address, but the user must ensure the validity of the address to jump to.*

42.2 Bootloader selection

The figures below show the bootloader selection mechanism.

Figure 55. Bootloader selection for STM32G47xxx/48xxx

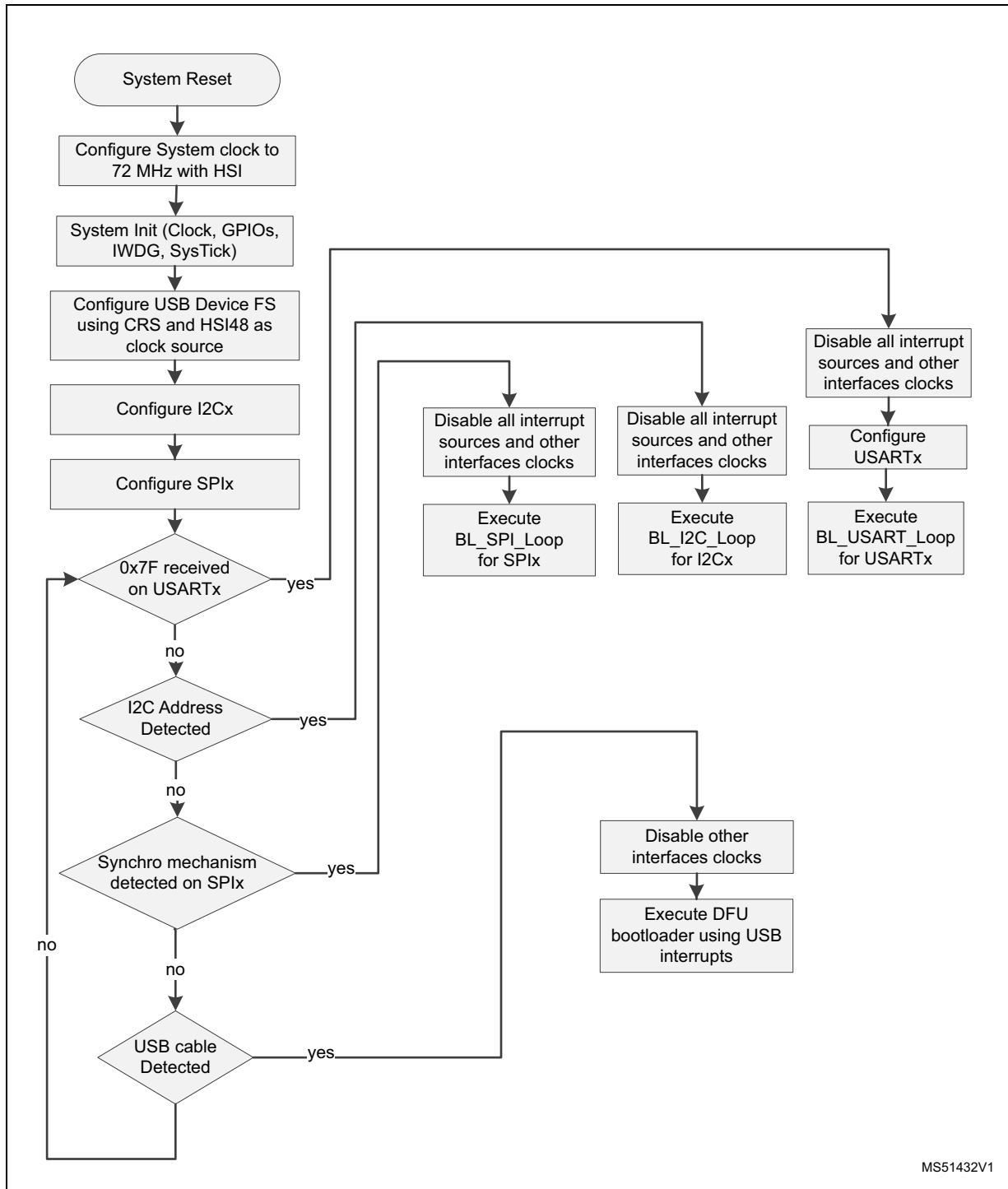
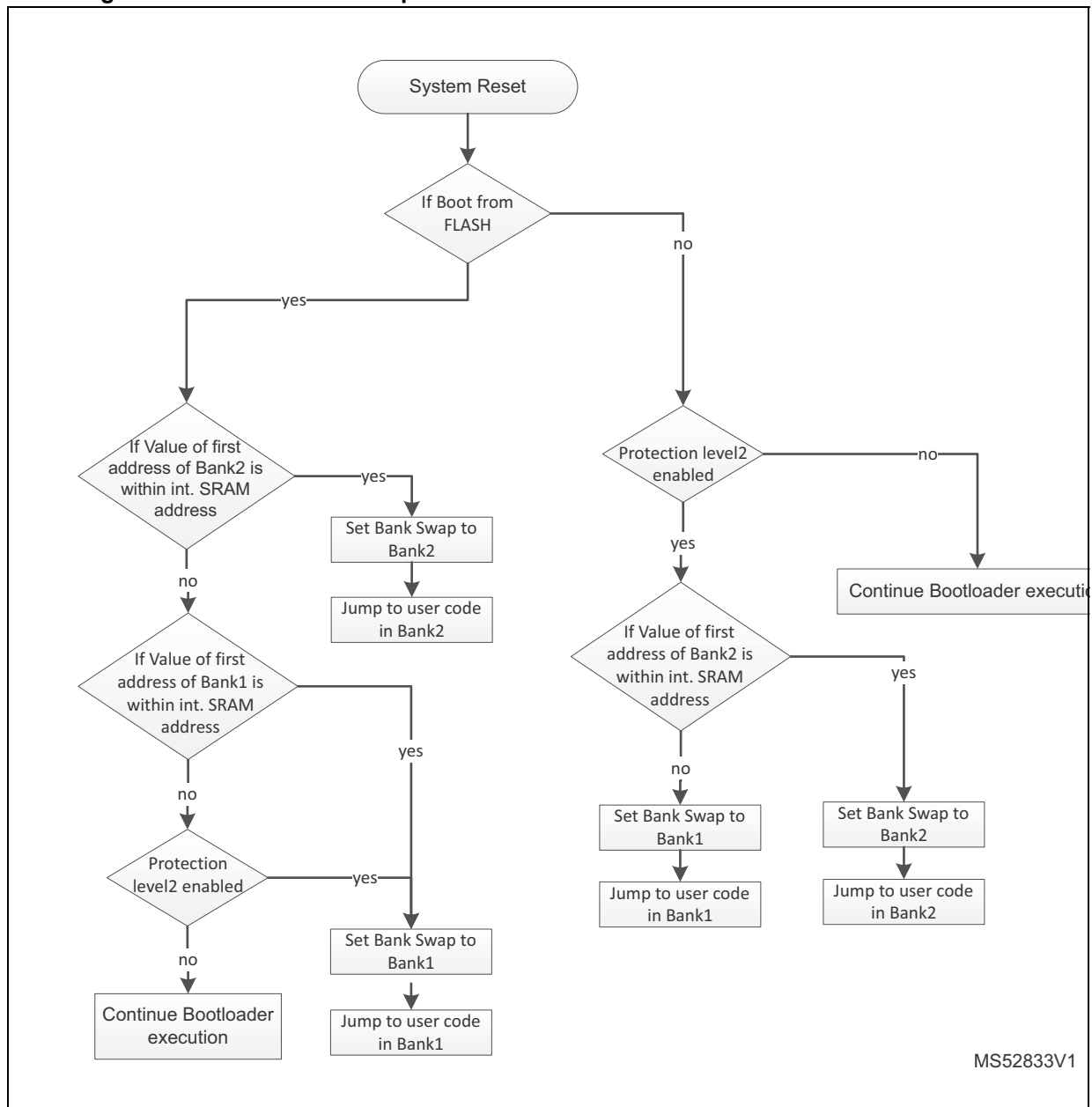

Figure 56. Dual bank boot implementation for STM32G47xxx/48xxx bootloader V13.x



42.3 Bootloader version

Table 89. STM32G47xxx/48xxx bootloader version

Bootloader version number	Description	Known limitations
V13.4	Initial bootloader version	None

43 STM32H74xxx/75xxx devices bootloader

43.1 Bootloader configuration

The STM32H74xxx/75xxx bootloader is activated by applying pattern10 (described in [Table 2: Bootloader activation patterns](#)). The following table shows the hardware resources used by this bootloader.

Table 90. STM32H74xxx/75xxx configuration in system memory boot mode

Bootloader	Feature/Peripheral	State	Comment
Common to all bootloaders	RCC	HSI enabled	The system clock frequency is 64 MHz using the HSI. The HSI clock source is used at startup (interface detection phase) and when USART or SPI or I2C interface is selected.
		-	The clock recovery system (CRS) is enabled for the DFU bootloader to allow USB to be clocked by HSI48 48 MHz
		-	Clock used for the FDCAN is fixed to 20 MHz and is derived from PPLQ
	RAM	-	16 Kbyte starting from address 0x20000000, and 208 Kbyte starting from address 0x24000000 are used by the bootloader firmware
	System memory	-	122 Kbyte starting from address 0x1FFF0000, contain the bootloader firmware
	IWDG	-	The independent watchdog (IWDG) prescaler is configured to its maximum value. It is periodically refreshed to prevent watchdog reset (in case the hardware IWDG option was previously enabled by the user).
	Power	-	Voltage range is set to Voltage Range 3.
USART1 bootloader (on PA9/PA10)	USART1	Enabled	Once initialized the USART1 configuration is: 8-bits, even parity and 1 Stop bit
	USART1_RX pin	Input	PA10 pin: USART1 in reception mode
	USART1_TX pin	Output	PA9 pin: USART1 in transmission mode
USART1 bootloader (on PB14/PB15)	USART1	Enabled	Once initialized the USART1 configuration is: 8-bits, even parity and 1 Stop bit
	USART1_RX pin	Input	PB15 pin: USART1 in reception mode
	USART1_TX pin	Output	PB14 pin: USART1 in transmission mode
USART2 bootloader	USART2	Enabled	Once initialized the USART2 configuration is: 8-bits, even parity and 1 Stop bit
	USART2_RX pin	Input	PA3 pin: USART2 in reception mode
	USART2_TX pin	Output	PA2 pin: USART2 in transmission mode

Table 90. STM32H74xxx/75xxx configuration in system memory boot mode (continued)

Bootloader	Feature/Peripheral	State	Comment
USART3 bootloader	USART3	Enabled	Once initialized the USART3 configuration is: 8-bits, even parity and 1 Stop bit
	USART3_RX pin	Input	PB11 pin: USART3 in reception mode
	USART3_TX pin	Output	PB10 pin: USART3 in transmission mode
I2C1 bootloader	I2C1	Enabled	The I2C1 configuration is: I2C speed: up to 400 KHz, 7-bit address, slave mode, analog filter ON. Slave 7-bit address: 0b1001110x (where x = 0 for write and x = 1 for read)
	I2C1_SCL pin	Input/Output	PB6 pin: clock line is used in open-drain mode.
	I2C1_SDA pin	Input/Output	PB9 pin: data line is used in open-drain mode.
I2C2 bootloader	I2C2	Enabled	The I2C2 configuration is: I2C speed: up to 400 KHz, 7-bit address, slave mode, analog filter ON. Slave 7-bit address: 0b1001110x (where x = 0 for write and x = 1 for read)
	I2C2_SCL pin	Input/Output	PF1 pin: clock line is used in open-drain mode.
	I2C2_SDA pin	Input/Output	PF0 pin: data line is used in open-drain mode.
I2C3 bootloader	I2C3	Enabled	The I2C3 configuration is: I2C speed: up to 400 KHz, 7-bit address, slave mode, analog filter ON. Slave 7-bit address: 0b1001110x (where x = 0 for write and x = 1 for read)
	I2C3_SCL pin	Input/Output	PA8 pin: clock line is used in open-drain mode.
	I2C3_SDA pin	Input/Output	PC9 pin: data line is used in open-drain mode.
SPI1 bootloader	SPI1	Enabled	The SPI1 configuration is: – Slave mode – Full Duplex – 8-bit MSB – Speed up to 8 MHz – Polarity: CPOL Low, CPHA Low, NSS hardware.
	SPI1_MOSI pin	Input	PA7 pin: Slave data Input line, used in push-pull, no pull-up no pull-down mode.
	SPI1_MISO pin	Output	PA6 pin: Slave data output line, used in push-pull, no pull-up no pull-down mode.
	SPI1_SCK pin	Input	PA5 pin: Slave clock line, used in push-pull no pull-up, no pull-up no pull-down mode.
	SPI1_NSS pin	Input	PA4 pin: slave chip select pin used in push-pull, no pull-up no pull-down mode.

Table 90. STM32H74xxx/75xxx configuration in system memory boot mode (continued)

Bootloader	Feature/Peripheral	State	Comment
SPI2 bootloader	SPI2	Enabled	The SPI2 configuration is: – Slave mode – Full Duplex – 8-bit MSB – Speed up to 8 MHz – Polarity: CPOL Low, CPHA Low, NSS hardware.
	SPI2_MOSI pin	Input	PI3 pin: Slave data Input line, used in push-pull, no pull-up no pull-down mode.
	SPI2_MISO pin	Output	PI2 pin: Slave data output line, used in push-pull, no pull-up no pull-down mode.
	SPI2_SCK pin	Input	PI1 pin: Slave clock line, used in push-pull, no pull-up no pull-down mode.
	SPI2_NSS pin	Input	PI0 pin: slave chip select pin used in push-pull, no pull-up no pull-down mode.
SPI3 bootloader	SPI3	Enabled	The SPI3 configuration is: – Slave mode – Full Duplex – 8-bit MSB – Speed up to 8 MHz – Polarity: CPOL Low, CPHA Low, NSS hardware.
	SPI3_MOSI pin	Input	PC12 pin: Slave data Input line, used in push-pull, no pull-up no-pull down mode
	SPI3_MISO pin	Output	PC11 pin: Slave data output line, used in push-pull, no pull-up no-pull down mode.
	SPI3_SCK pin	Input	PC10 pin: Slave clock line, used in push-pull, no pull-up no-pull down mode.
	SPI3_NSS pin	Input	PA15 pin: slave chip select pin used in push-pull, no pull-up no pull-down mode.
SPI4 bootloader	SPI4	Enabled	The SPI4 configuration is: – Slave mode – Full Duplex – 8-bit MSB – Speed up to 8 MHz – Polarity: CPOL Low, CPHA Low, NSS hardware.
	SPI4_MOSI pin	Input	PE14 pin: Slave data Input line, used in push-pull, no pull-up no pull-down mode.
	SPI4_MISO pin	Output	PE13 pin: Slave data output line, used in push-pull, no pull-up no pull-down mode.
	SPI4_SCK pin	Input	PE12 pin: Slave clock line, used in push-pull, no pull-up no pull-down mode.
	SPI4_NSS pin	Input	PE11 pin: slave chip select pin used in push-pull, no pull-up no pull-down mode.

Table 90. STM32H74xxx/75xxx configuration in system memory boot mode (continued)

Bootloader	Feature/Peripheral	State	Comment
DFU bootloader	USB	Enabled	USB FS configured in forced device mode. USB FS interrupt vector is enabled and used for USB DFU communications.
	USB_DM pin	Input/Output	PA11: USB DM line.
	USB_DP pin		PA12: USB DP line No external Pull-up resistor is required
FDCAN bootloader	FDCAN1	Enabled	Once initialized the FDCAN1 configuration is: bit-rate 0.5 Mbps FrameFormat = FDCAN_FRAME_FD_BRS Mode = FDCAN_MODE_NORMAL AutoRetransmission = ENABLE TransmitPause = DISABLE ProtocolException = ENABLE
	FDCAN1_Rx pin	Input	PH14 pin: FDCAN1 in reception mode
	FDCAN1_Tx pin	Output	PH13 pin: FDCAN1 in transmission mode

Note: To be able to connect to the bootloader USART1 using PB14/PB15 pins, you need to send two synchronization bytes.

43.2 Bootloader selection

The *Figure 57* shows the bootloader selection mechanism.

Figure 57. Bootloader V9.x selection for STM32H74xxx/75xxx

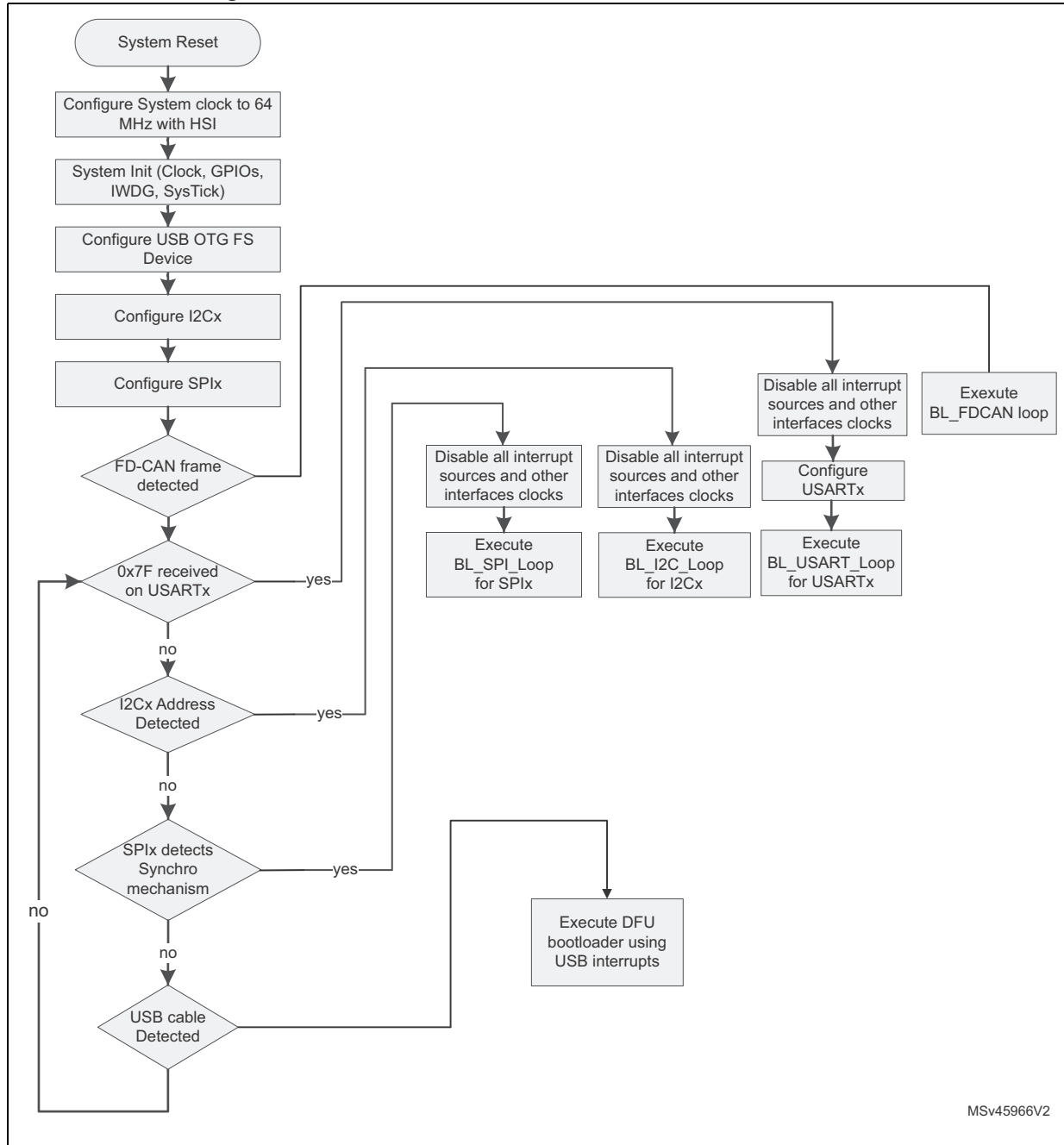

MSv45966V2

43.3 Bootloader version

Table 91 lists the STM32H74xxx/75xxx devices bootloader versions.



Table 91. STM32H74xxx/75xxx bootloader version

Bootloader version number	Description	Known limitations
V13.2	Initial bootloader version	<ul style="list-style-type: none"> – “Go” Command is not working – USART2 connection is not working – SPI1 connection is not working – Mass erase is not working well on I2C (Only Bank2 is erased in this command)
V13.3	<ul style="list-style-type: none"> – Switch USB clock input from HSE to HSI48 with CRS – Fix known limitations on the V13.2 	<ul style="list-style-type: none"> – Bank erase is not working on USART/SPI and I2C – DFU bootloader mass-erase not working
V9.0	<ul style="list-style-type: none"> – Add support of FDCAN interface – Fix V13.3 limitations 	<ul style="list-style-type: none"> – First ACK not received on “Go” Command when using USART or SPI – Limitation on the FDCAN write memory, write of data with length > 63 bytes is failing

44 STM32L01xxx/02xxx devices bootloader

44.1 Bootloader configuration

The STM32L01xxx/02xxx bootloader is activated by applying pattern6 (described in [Table 2: Bootloader activation patterns](#)). The following [Table 92](#) shows the hardware resources used by this bootloader.

Table 92. STM32L01xxx/02xxx configuration in system memory boot mode

Bootloader	Feature/Peripheral	State	Comment
Common to all bootloaders	RCC	HSI enabled	The system clock frequency is 32 MHz with HSI 16 MHz as clock source.
	RAM	-	2 Kbyte starting from address 0x20000000 are used by the bootloader firmware
	System memory	-	4 Kbyte starting from address 0x1FF00000, contain the bootloader firmware
	IWDG	-	The independent watchdog (IWDG) prescaler is configured to its maximum value. It is periodically refreshed to prevent watchdog reset (in case the hardware IWDG option was previously enabled by the user).
USART1 bootloader (on PA9/PA10)	USART1	Enabled	Once initialized the USART1 configuration is: 8-bits, even parity and 1 Stop bit
	USART1_RX pin	Input	PA10 pin: USART1 in reception mode
	USART1_TX pin	Output	PA9 pin: USART1 in transmission mode
USART2 bootloader (on PA2/PA3)	USART2	Enabled	Once initialized the USART2 configuration is: 8-bits, even parity and 1 Stop bit
	USART2_RX pin	Input	PA3 pin: USART2 in reception mode
	USART2_TX pin	Output	PA2 pin: USART2 in transmission mode
USART2 bootloader	SysTick timer	Enabled	Used to automatically detect the serial baud rate from the host for USARTx bootloaders.
SPI1 bootloader (for all device packages except TSSOP14)	SPI1	Enabled	The SPI1 configuration is: Slave mode, Full Duplex, 8-bit MSB, Speed up to 8 MHz, Polarity: CPOL Low, CPHA Low, NSS hardware.
	SPI1_MOSI pin	Input	PA7 pin: Slave data Input line, used in push-pull pull-down mode
	SPI1_MISO pin	Output	PA6 pin: Slave data output line, used in push-pull pull-down mode
	SPI1_SCK pin	Input	PA5 pin: Slave clock line, used in push-pull pull-down mode
	SPI1_NSS pin	Input	PA4 pin: slave chip select pin used in push-pull pull-up mode. Note: This IO can be tied to GND if the SPI Master does not use it.

Table 92. STM32L01xxx/02xxx configuration in system memory boot mode (continued)

Bootloader	Feature/Peripheral	State	Comment
SPI1 bootloader (only for devices on TSSOP14 package)	SPI1	Enabled	The SPI1 configuration is: Slave mode, Full Duplex, 8-bit MSB, Speed up to 8 MHz, Polarity: CPOL Low, CPHA Low, NSS hardware.
	SPI1_MOSI pin	Input	PA7 pin: Slave data Input line, used in push-pull pull-down mode
	SPI1_MISO pin	Output	PA14 pin: Slave data output line, used in push-pull pull-down mode. Note: This IO is also used as SWCLK for debug interface, as consequence debugger can not connect to the device in "on-the-fly" mode when the bootloader is running.
	SPI1_SCK pin	Input	PA13 pin: Slave clock line, used in push-pull pull-down mode
	SPI1_NSS pin	Input	PA4 pin: slave chip select pin used in push-pull pull-up mode. Note: NSS pin synchronization is required on bootloader with SPI1 interface for devices on TSSOP14 package.

The system clock is derived from the embedded internal high-speed RC for all bootloader interfaces. No external quartz is required for bootloader operations.

Note: Due to empty check mechanism present on this product, it is not possible to jump from user code to system bootloader. Such jump results in a jump back to user flash space. But if the first 4 bytes of user flash memory (at 0x0800 0000) are empty at the moment of the jump (ie. erase first sector before jump or execute code from SRAM while Flash is empty), then system bootloader will be executed when jumped to.

44.2 Bootloader selection

The [Table 58](#) shows the bootloader selection mechanism.

Figure 58. Bootloader selection for STM32L01xxx/02xxx

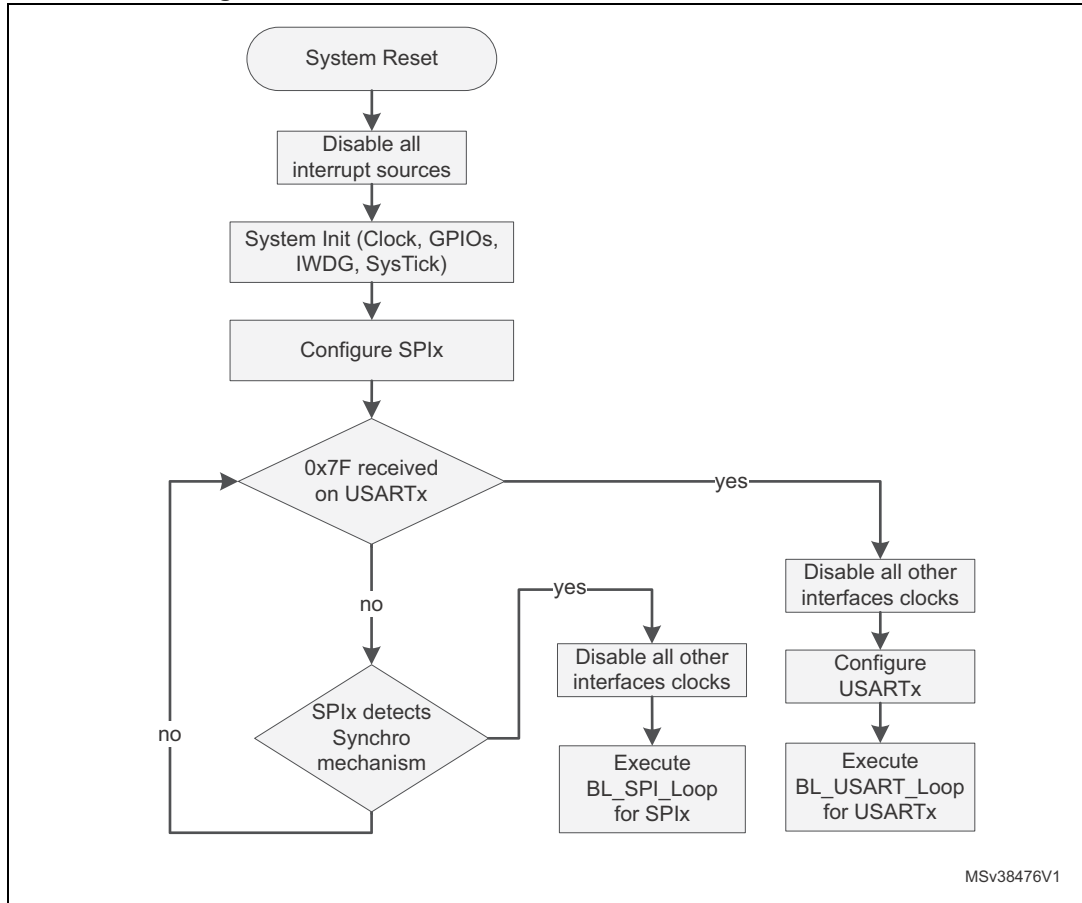

44.3 Bootloader version

The following table lists the STM32L01xxx/02xxx devices bootloader versions.

Table 93. STM32L01xxx/02xxx bootloader versions

Bootloader version number	Description	Known limitations
V12.2	Initial bootloader version	Bootloader not functional with SPI1 interface for devices on TSSOP14 package.
V12.3	This bootloader is an updated version of bootloader V12.2. This new version add support of SPI interface for devices on TSSOP14 package.	For the SPI1 interface for devices in TSSOP14, a falling edge on NSS pin is required before starting communication, to properly synchronize the SPI interface. If the NSS pin is grounded (all time from device reset) the SPI communication is not synchronized and bootloader does not work properly with the SPI interface.

45 STM32L031xx/041xx devices bootloader

45.1 Bootloader configuration

The STM32L031xx/041xx bootloader is activated by applying pattern2 (described in [Table 2: Bootloader activation patterns](#)). The following table shows the hardware resources used by this bootloader.

Table 94. STM32L031xx/041xx configuration in system memory boot mode

Bootloader	Feature/Peripheral	State	Comment
Common to all bootloaders	RCC	HSI enabled	The system clock frequency is 32 MHz with HSI 16 MHz as clock source.
	RAM	-	4 Kbyte starting from address 0x20000000 are used by the bootloader firmware
	System memory	-	4 Kbyte starting from address 0x1FF00000, contain the bootloader firmware
	IWDG	-	The independent watchdog (IWDG) prescaler is configured to its maximum value. It is periodically refreshed to prevent watchdog reset (in case the hardware IWDG option was previously enabled by the user).
USART2 bootloader (on PA9/PA10)	USART2	Enabled	Once initialized the USART2 configuration is: 8-bits, even parity and 1 Stop bit
	USART2_RX pin	Input	PA10 pin: USART2 in reception mode
	USART2_TX pin	Output	PA9 pin: USART2 in transmission mode
USART2 bootloader (on PA2/PA3)	USART2	Enabled	Once initialized the USART2 configuration is: 8-bits, even parity and 1 Stop bit
	USART2_RX pin	Input	PA3 pin: USART2 in reception mode
	USART2_TX pin	Output	PA2 pin: USART2 in transmission mode
USART2 bootloader	SysTick timer	Enabled	Used to automatically detect the serial baud rate from the host for USARTx bootloaders.

Table 94. STM32L031xx/041xx configuration in system memory boot mode (continued)

Bootloader	Feature/Peripheral	State	Comment
SPI1 bootloader	SPI1	Enabled	The SPI1 configuration is: Slave mode, Full Duplex, 8-bit MSB, Speed up to 8 MHz, Polarity: CPOL Low, CPHA Low, NSS hardware.
	SPI1_MOSI pin	Input	PA7 pin: Slave data Input line, used in push-pull pull-down mode
	SPI1_MISO pin	Output	PA6 pin: Slave data output line, used in push-pull pull-down mode
	SPI1_SCK pin	Input	PA5 pin: Slave clock line, used in push-pull pull-down mode
	SPI1_NSS pin	Input	PA4 pin: slave chip select pin used in push-pull pull-up mode. Note: This IO can be tied to GND if the SPI Master does not use it.

The system clock is derived from the embedded internal high-speed RC for all bootloader interfaces. No external quartz is required for bootloader operations.

The bootloader Read/Write commands don't support SRAM memory space for this product.

45.2 Bootloader selection

The [Figure 59](#) shows the bootloader selection mechanism.

Figure 59. Bootloader selection for STM32L031xx/041xx

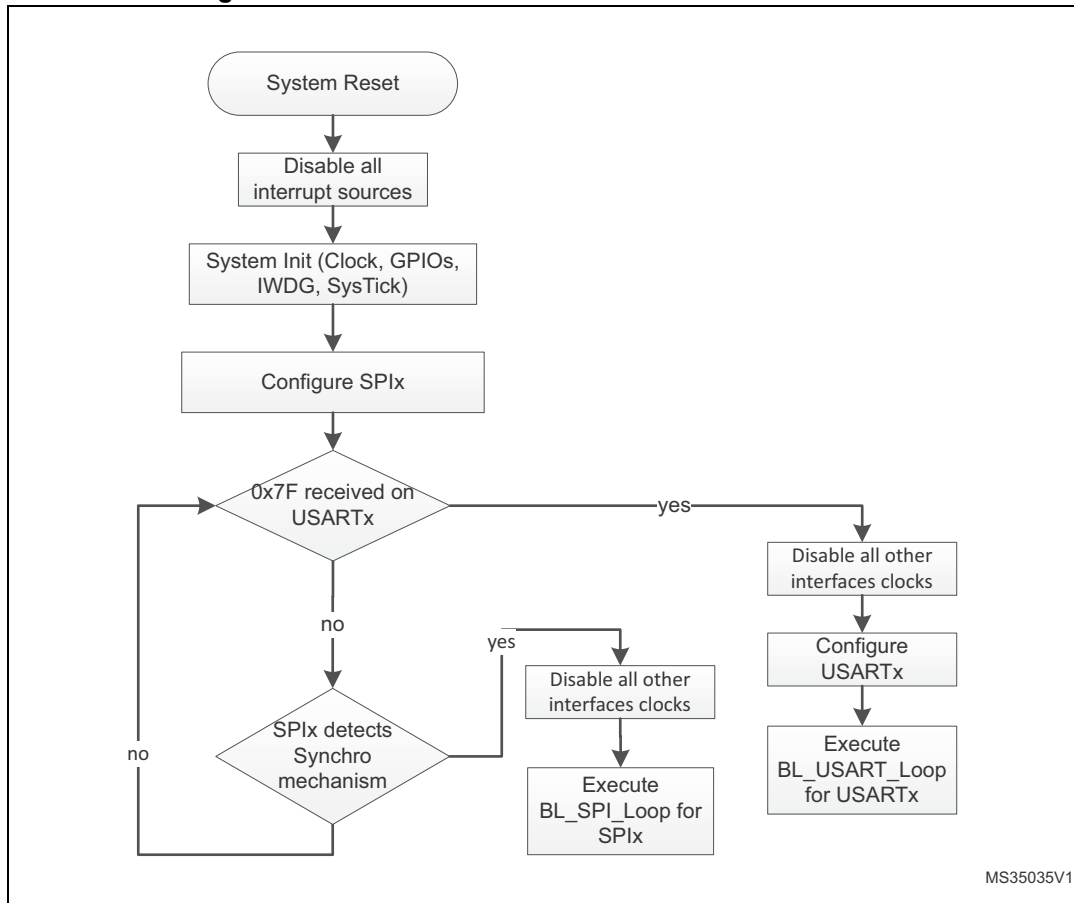

45.3 Bootloader version

The [Table 95](#) lists the STM32L031xx/041xx devices bootloader versions:

Table 95. STM32L031xx/041xx bootloader versions

Bootloader version number	Description	Known limitations
V12.0	Initial bootloader version	None

46 STM32L05xxx/06xxx devices bootloader

46.1 Bootloader configuration

The STM32L05xxx/06xxx bootloader is activated by applying pattern1 (described in [Table 2: Bootloader activation patterns](#)). The following table shows the hardware resources used by this bootloader.

Table 96. STM32L05xxx/06xxx configuration in system memory boot mode

Bootloader	Feature/Peripheral	State	Comment
Common to all bootloaders	RCC	HSI enabled	The system clock frequency is 32 MHz with HSI 16 MHz as clock source.
	Power	-	Voltage range is set to Voltage Range 1.
	RAM	-	4 Kbyte starting from address 0x20000000 are used by the bootloader firmware
	System memory	-	4 Kbyte starting from address 0x1FF00000, contain the bootloader firmware
	IWDG	-	The independent watchdog (IWDG) prescaler is configured to its maximum value. It is periodically refreshed to prevent watchdog reset (in case the hardware IWDG option was previously enabled by the user).
USART1 bootloader	USART1	Enabled	Once initialized the USART1 configuration is: 8-bits, even parity and 1 Stop bit
	USART1_RX pin	Input	PA10 pin: USART1 in reception mode
	USART1_TX pin	Output	PA9 pin: USART1 in transmission mode
USART2 bootloader	USART2	Enabled	Once initialized the USART2 configuration is: 8-bits, even parity and 1 Stop bit
	USART2_RX pin	Input	PA3 pin: USART2 in reception mode
	USART2_TX pin	Output	PA2 pin: USART2 in transmission mode
USARTx bootloaders	SysTick timer	Enabled	Used to automatically detect the serial baud rate from the host for USARTx bootloaders.

Table 96. STM32L05xxx/06xxx configuration in system memory boot mode (continued)

Bootloader	Feature/Peripheral	State	Comment
SPI1 bootloader	SPI1	Enabled	The SPI1 configuration is: Slave mode, Full Duplex, 8-bit MSB, Speed up to 8 MHz, Polarity: CPOL Low, CPHA Low, NSS hardware.
	SPI1_MOSI pin	Input	PA7 pin: Slave data Input line, used in push-pull pull-down mode
	SPI1_MISO pin	Output	PA6 pin: Slave data output line, used in push-pull pull-down mode
	SPI1_SCK pin	Input	PA5 pin: Slave clock line, used in push-pull pull-down mode
	SPI1_NSS pin	Input	PA4 pin: slave chip select pin used in push-pull pull-down mode.
SPI2 bootloader	SPI2	Enabled	The SPI2 configuration is: Slave mode, Full Duplex, 8-bit MSB, Speed up to 8 MHz, Polarity: CPOL Low, CPHA Low, NSS hardware.
	SPI2_MOSI pin	Input	PB15 pin: Slave data Input line, used in push-pull pull-down mode
	SPI2_MISO pin	Output	PB14 pin: Slave data output line, used in push-pull pull-down mode
	SPI2_SCK pin	Input	PB13 pin: Slave clock line, used in push-pull pull-down mode
	SPI2_NSS pin	Input	PB12 pin: slave chip select pin used in push-pull pull-down mode.

The system clock is derived from the embedded internal high-speed RC for all bootloader interfaces. No external quartz is required for bootloader operations.

46.2 Bootloader selection

The figure below shows the bootloader selection mechanism.

Figure 60. Bootloader selection for STM32L05xxx/06xxx

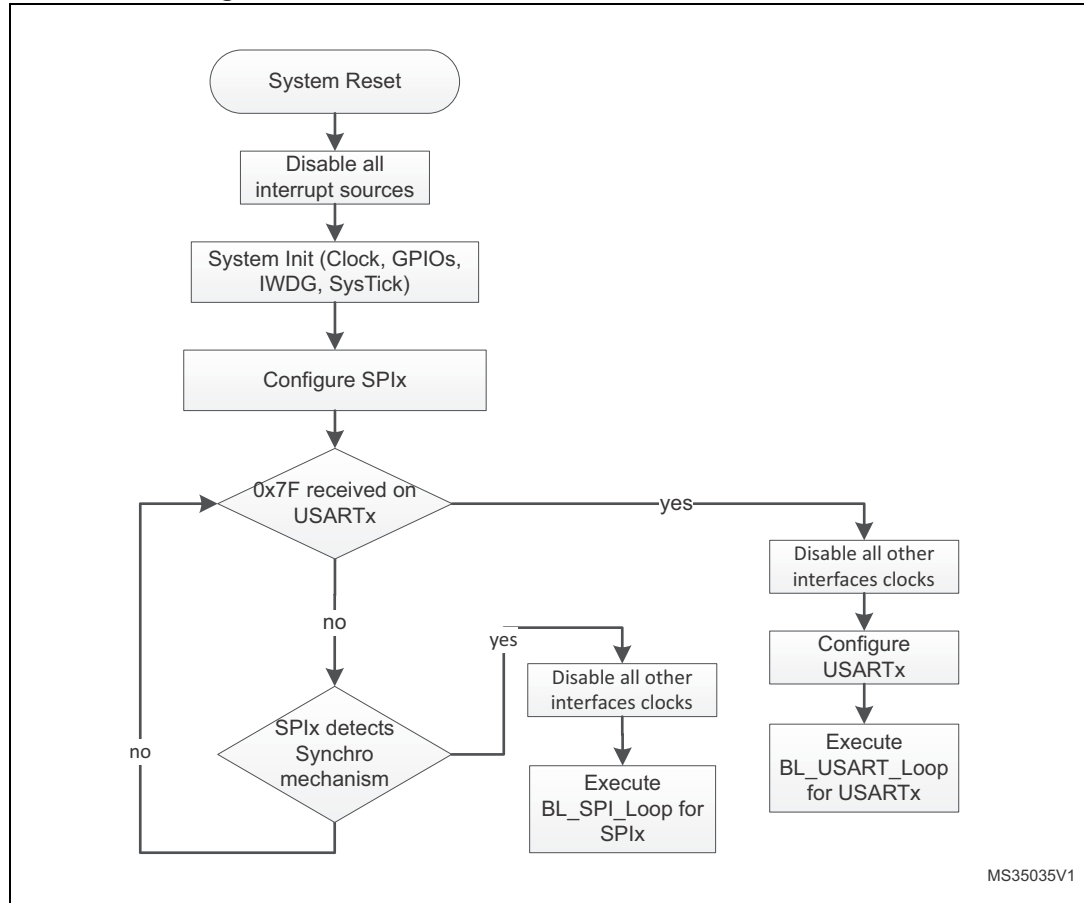

46.3 Bootloader version

The following table lists the STM32L05xxx/06xxx devices bootloader versions:

Table 97. STM32L05xxx/06xxx bootloader versions

Bootloader version number	Description	Known limitations
V12.0	Initial bootloader version	None

47 STM32L07xxx/08xxx devices bootloader

Two bootloader versions are available on STM32L07xxx/08xxx devices:

- V4.x supporting USART1, USART2 and DFU (USB FS Device).
This version is embedded in STM32L072xx/73xx and STM32L082xx/83xx devices.
- V11.x supporting USART1, USART2, I2C1, I2C2, SPI1 and SPI2.
This version is embedded in other STM32L071xx/081xx devices.

47.1 Bootloader V4.x

47.1.1 Bootloader configuration

The STM32L07xxx/08xxx bootloader is activated by applying pattern2 or pattern7 when dual bank boot feature is available (described in [Table 2: Bootloader activation patterns](#)). The [Table 98](#) shows the hardware resources used by this bootloader.

Table 98. STM32L07xxx/08xxx configuration in system memory boot mode

Bootloader	Feature/Peripheral	State	Comment
Common to all bootloaders	RCC	HSI enabled	The system clock frequency is 32 MHz with HSI 16 MHz as clock source.
	RAM	-	4 Kbyte starting from address 0x20000000 are used by the bootloader firmware.
	System memory	-	8 Kbyte starting from address 0x1FF00000, contain the bootloader firmware.
	IWDG	-	The independent watchdog (IWDG) prescaler is configured to its maximum value. It is periodically refreshed to prevent watchdog reset (in case the hardware IWDG option was previously enabled by the user).
USART1 bootloader	USART1	Enabled	Once initialized the USART1 configuration is: 8-bits, even parity and 1 Stop bit
	USART1_RX pin	Input	PA10 pin: USART2 in reception mode
	USART1_TX pin	Output	PA9 pin: USART2 in transmission mode
USART2 bootloader	USART2	Enabled	Once initialized the USART2 configuration is: 8-bits, even parity and 1 Stop bit
	USART2_RX pin	Input	PA3 pin: USART2 in reception mode
	USART2_TX pin	Output	PA2 pin: USART2 in transmission mode
USARTx bootloaders	SysTick timer	Enabled	Used to automatically detect the serial baud rate from the host for USARTx bootloaders.

Table 98. STM32L07xxx/08xxx configuration in system memory boot mode (continued)

Bootloader	Feature/Peripheral	State	Comment
DFU bootloader	USB	Enabled	USB FS configured in forced device mode. USB FS interrupt vector is enabled and used for USB DFU communications.
	USB_DM pin	Input/Output	PA11 pin: USB FS DM line
	USB_DP pin		PA12 pin: USB FS DP line. No external Pull-up resistor is required.

The system clock is derived from the embedded internal high-speed RC for all bootloader interfaces. No external quartz is required for bootloader operations.

47.1.2 Bootloader selection

The [Figure 61](#) and [Figure 62](#) show the bootloader selection mechanism.

Figure 61. Dual Bank Boot Implementation for STM32L07xxx/08xxx bootloader V4.x

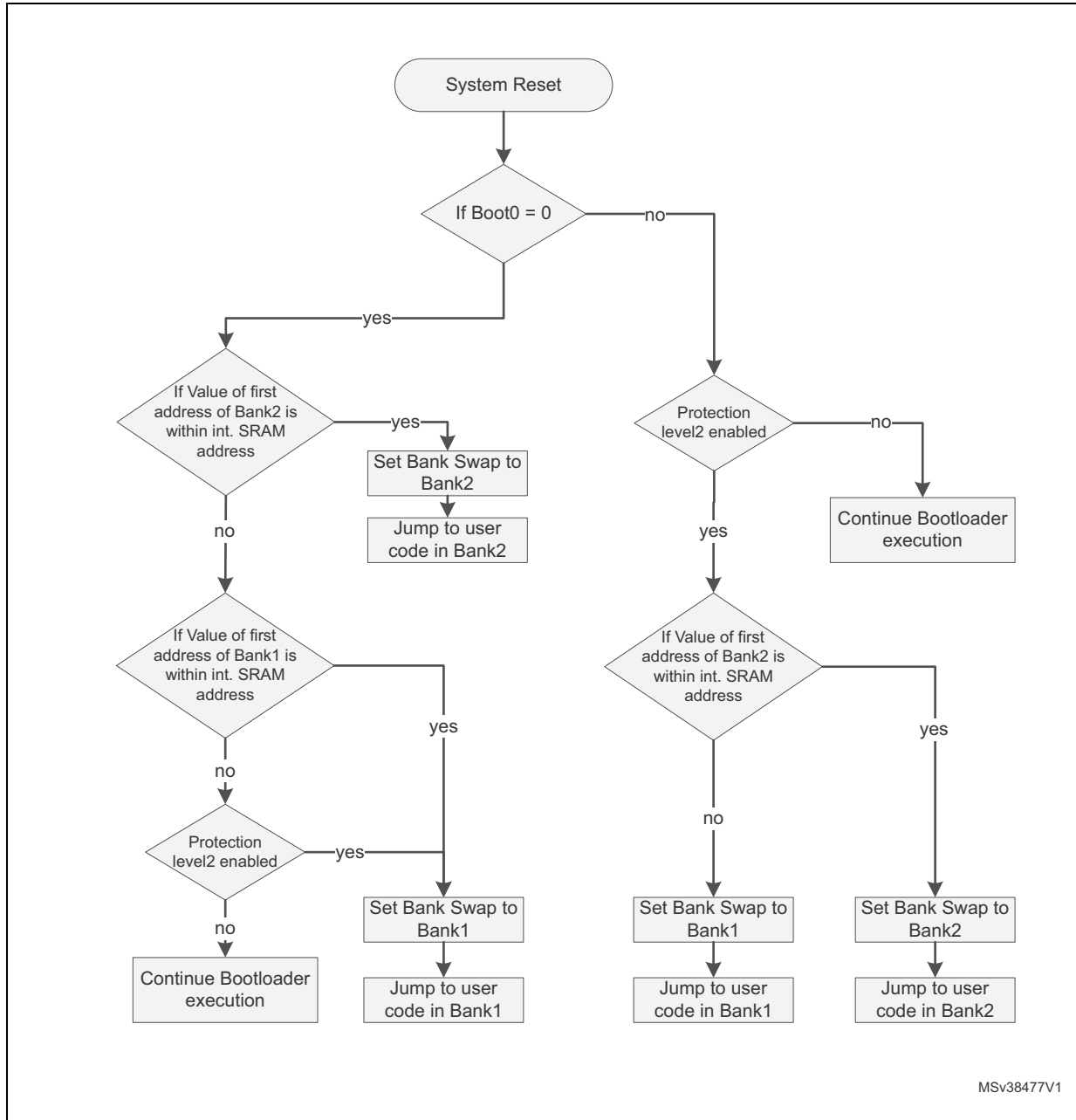
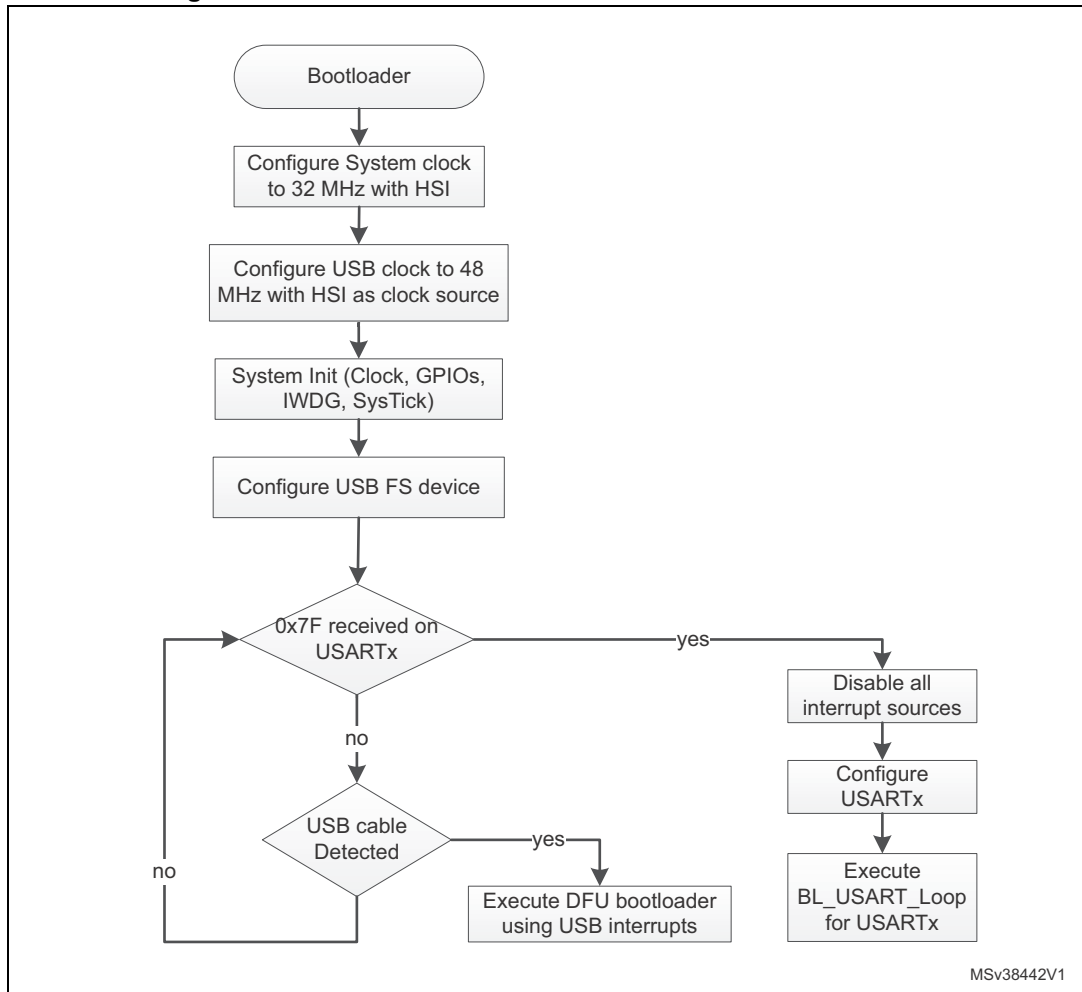

Figure 62. Bootloader V4.x selection for STM32L07xxx/08xxx



47.1.3 Bootloader version

The [Table 99](#) lists the STM32L07xxx/08xxx devices bootloader versions:

Table 99. STM32L07xxx/08xxx bootloader versions

Bootloader version number	Description	Known limitations
V4.0	Initial bootloader version	None
V4.1	This bootloader is an updated version of bootloader V4.0. This new version implements the Dual Bank Boot feature.	None

47.2 Bootloader V11.x

47.2.1 Bootloader configuration

The STM32L07xxx/08xxx bootloader is activated by applying pattern2 or pattern7 when dual bank boot feature is available (described in [Table 2: Bootloader activation patterns](#)). The [Table 100](#) shows the hardware resources used by this bootloader.

Table 100. STM32L07xxx/08xxx configuration in system memory boot mode

Bootloader	Feature/Peripheral	State	Comment
Common to all bootloaders	RCC	HSI enabled	The system clock frequency is 32 MHz with HSI 16 MHz as clock source.
	RAM	-	5 Kbyte starting from address 0x20000000 are used by the bootloader firmware
	System memory	-	8 Kbyte starting from address 0x1FF00000, contain the bootloader firmware
	IWDG	-	The independent watchdog (IWDG) prescaler is configured to its maximum value. It is periodically refreshed to prevent watchdog reset (in case the hardware IWDG option was previously enabled by the user).
USART1 bootloader	USART1	Enabled	Once initialized the USART1 configuration is: 8-bits, even parity and 1 Stop bit
	USART1_RX pin	Input	PA10 pin: USART2 in reception mode
	USART1_TX pin	Output	PA9 pin: USART2 in transmission mode
USART2 bootloader	USART2	Enabled	Once initialized the USART2 configuration is: 8-bits, even parity and 1 Stop bit
	USART2_RX pin	Input	PA3 pin: USART2 in reception mode
	USART2_TX pin	Output	PA2 pin: USART2 in transmission mode
USARTx bootloaders	SysTick timer	Enabled	Used to automatically detect the serial baud rate from the host for USARTx bootloaders.
I2C1 bootloader	I2C1	Enabled	The I2C1 configuration is: I2C speed: up to 400 KHz, 7-bit address, slave mode, analog filter ON. Slave 7-bit address: 0b1000010x (where x = 0 for write and x = 1 for read)
	I2C1_SCL pin	Input/Output	PB6 pin: I2C1 clock line is used in open-drain mode.
	I2C1_SDA pin	Input/Output	PB7 pin: I2C1 data line is used in open-drain mode.

Table 100. STM32L07xxx/08xxx configuration in system memory boot mode (continued)

Bootloader	Feature/Peripheral	State	Comment
I2C2 bootloader	I2C2	Enabled	The I2C2 configuration is: I2C speed: up to 400 KHz, 7-bit address, slave mode, analog filter ON. Slave 7-bit address: 0b1000010x (where x = 0 for write and x = 1 for read)
	I2C2_SCL pin	Input/Output	PB10 pin: I2C2 clock line is used in open-drain mode.
	I2C2_SDA pin	Input/Output	PB11 pin: I2C2 data line is used in open-drain mode.
SPI1 bootloader	SPI1	Enabled	The SPI1 configuration is: Slave mode, Full Duplex, 8-bit MSB, Speed up to 8 MHz, Polarity: CPOL Low, CPHA Low, NSS hardware.
	SPI1_MOSI pin	Input	PA7 pin: Slave data Input line, used in push-pull pull-down mode
	SPI1_MISO pin	Output	PA6 pin: Slave data output line, used in push-pull pull-down mode
	SPI1_SCK pin	Input	PA5 pin: Slave clock line, used in push-pull pull-down mode
	SPI1_NSS pin	Input	PA4 pin: slave chip select pin used in push-pull pull-up mode. Note: This IO can be tied to Gnd if the SPI Master does not use it.
SPI2 bootloader	SPI2	Enabled	The SPI2 configuration is: Slave mode, Full Duplex, 8-bit MSB, Speed up to 8 MHz, Polarity: CPOL Low, CPHA Low, NSS hardware.
	SPI2_MOSI pin	Input	PB15 pin: Slave data Input line, used in push-pull pull-down mode
	SPI2_MISO pin	Output	PB14 pin: Slave data output line, used in push-pull pull-down mode
	SPI2_SCK pin	Input	PB13 pin: Slave clock line, used in push-pull pull-down mode
		SPI2_NSS pin	Input

The system clock is derived from the embedded internal high-speed RC for all bootloader interfaces. No external quartz is required for bootloader operations.

47.2.2 Bootloader selection

The [Figure 63](#) and [Figure 64](#) show the bootloader selection mechanism.

Figure 63. Dual Bank Boot Implementation for STM32L07xxx/08xxx bootloader V11.x

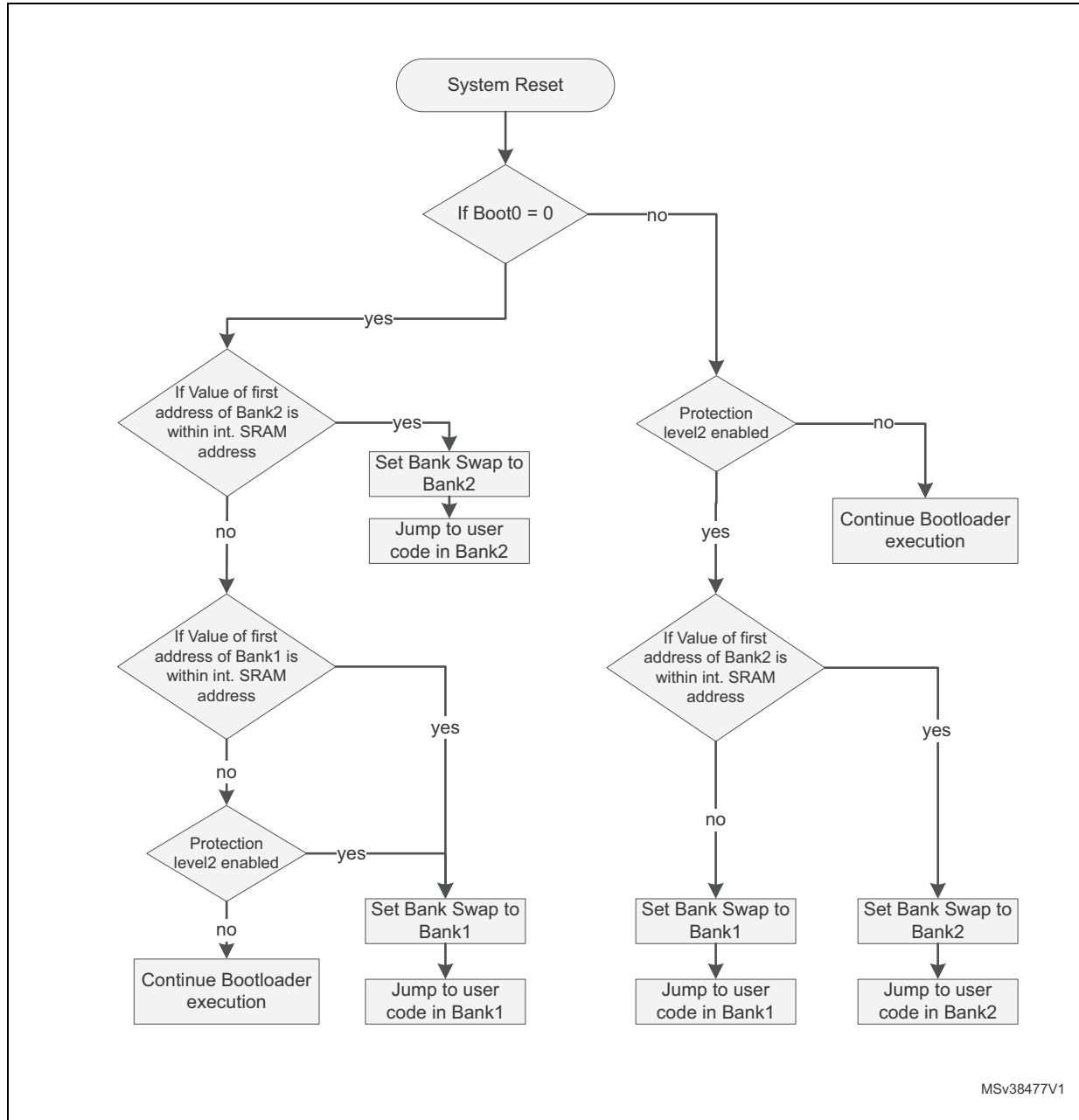
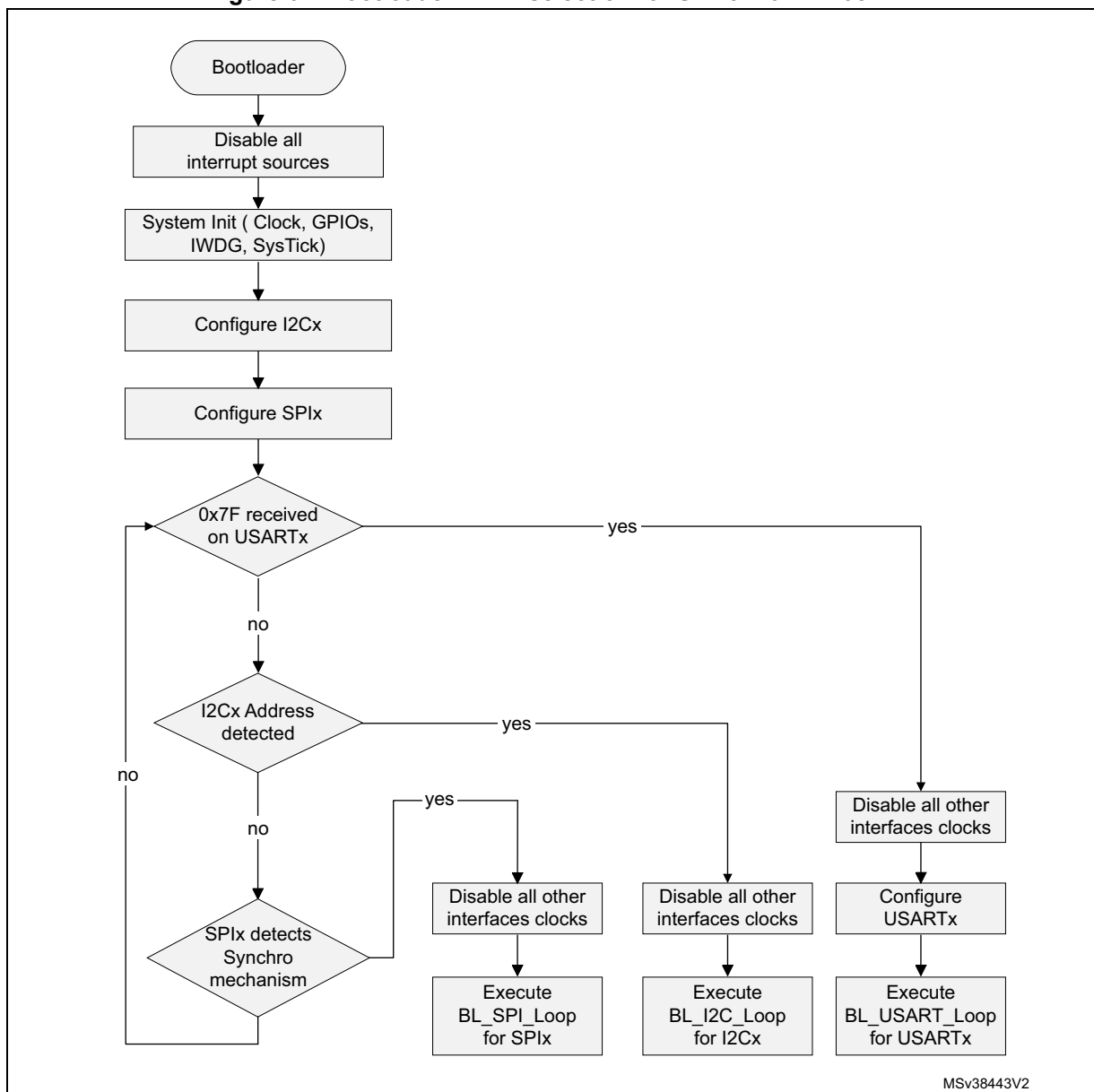

Figure 64. Bootloader V11.x selection for STM32L07xxx/08xxx



47.2.3 Bootloader version

The following table lists the STM32L07xxx/08xxx devices bootloader versions:

Table 101. STM32L07xxx/08xxx bootloader V11.x versions

Bootloader version number	Description	Known limitations
V11.1	Initial bootloader version	None
V11.2	This bootloader is an updated version of bootloader V11.1. This new version implements the Dual Bank Boot feature.	None

48 STM32L1xxx6(8/B)A devices bootloader

48.1 Bootloader configuration

The STM32L1xxx6(8/B)A bootloader is activated by applying pattern1 (described in [Table 2: Bootloader activation patterns](#)). The following table shows the hardware resources used by this bootloader.

Table 102. STM32L1xxx6(8/B)A configuration in system memory boot mode

Bootloader	Feature/Peripheral	State	Comment
Common to all bootloaders	RCC	HSI enabled	The system clock frequency is 16 MHz.
	RAM	-	2 Kbyte starting from address 0x20000000 are used by the bootloader firmware.
	System memory	-	4 Kbyte starting from address 0x1FF00000 contain the bootloader firmware.
	IWDG	-	The independent watchdog (IWDG) prescaler is configured to its maximum value and is periodically refreshed to prevent watchdog reset (in case the hardware IWDG option was previously enabled by the user).
	Power	-	Voltage range is set to Voltage Range 1.
USART1 bootloader	USART1	Enabled	Once initialized, the USART1 configuration is: 8 bits, even parity and 1 Stop bit.
	USART1_RX pin	Input	PA10 pin: USART1 in reception mode
	USART1_TX pin	Output	PA9 pin: USART1 in transmission mode
USART2 bootloader	USART2	Enabled	Once initialized, the USART2 configuration is: 8 bits, even parity and 1 Stop bit.
	USART2_RX pin	Input	PD6 pin: USART2 in reception mode
	USART2_TX pin	Output	PD5 pin: USART2 in transmission mode
USARTx bootloaders	SysTick timer	Enabled	Used to automatically detect the serial baud rate from the host.

The system clock is derived from the embedded internal high-speed RC, no external quartz is required for the bootloader execution.

48.2 Bootloader selection

The figure below shows the bootloader selection mechanism.

Figure 65. Bootloader selection for STM32L1xxx6(8/B)A devices

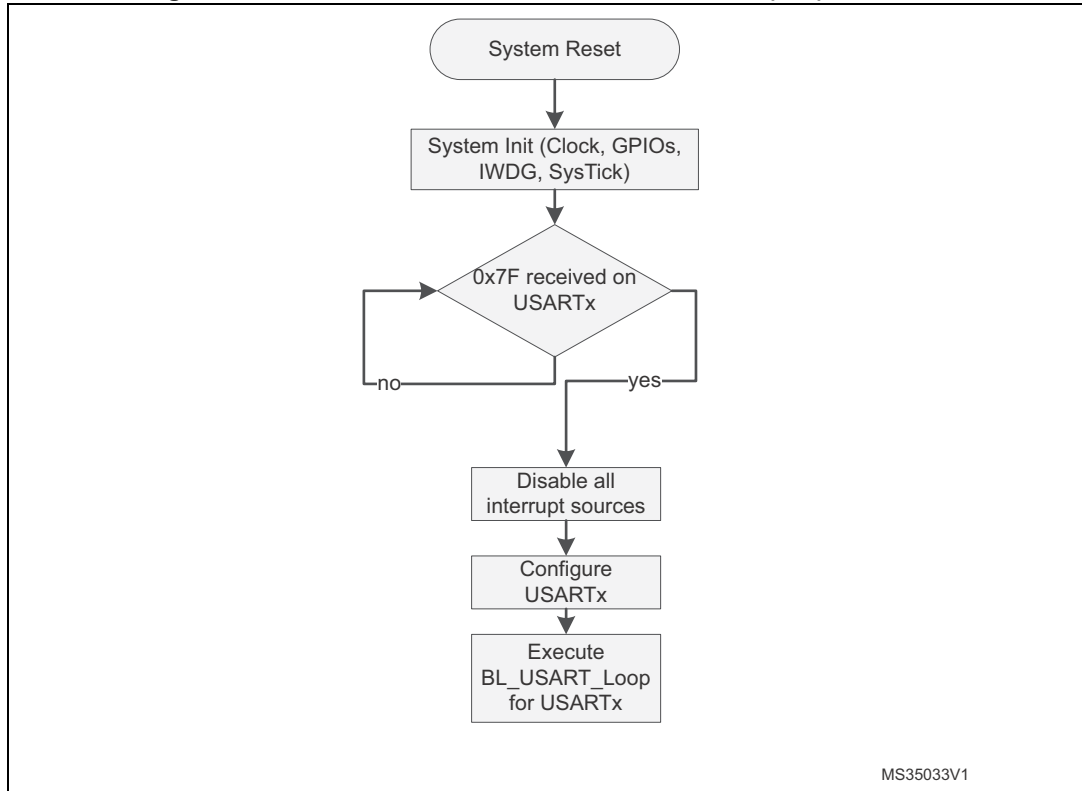

48.3 Bootloader version

The following table lists the STM32L1xxx6(8/B)A devices bootloader versions:

Table 103. STM32L1xxx6(8/B)A bootloader versions

Bootloader version number	Description	Known limitations
V2.0	Initial bootloader version	When a Read Memory command or Write Memory command is issued with an unsupported memory address and a correct address checksum (ie. address 0x6000 0000), the command is aborted by the bootloader device, but the NACK (0x1F) is not sent to the host. As a result, the next 2 bytes (which are the number of bytes to be read/written and its checksum) are considered as a new command and its checksum. ⁽¹⁾

1. If the “number of data - 1” (N-1) to be read/written is not equal to a valid command code, then the limitation is not perceived from the host since the command is NACKed anyway (as an unsupported new command).

49 STM32L1xxx6(8/B) devices bootloader

49.1 Bootloader configuration

The STM32L1xxx6(8/B) bootloader is activated by applying pattern1 (described in [Table 2: Bootloader activation patterns](#)). The following table shows the hardware resources used by this bootloader.

Table 104. STM32L1xxx6(8/B) configuration in system memory boot mode

Bootloader	Feature/Peripheral	State	Comment
Common to all bootloaders	RCC	HSI enabled	The system clock frequency is 16 MHz.
	RAM	-	2 Kbyte starting from address 0x20000000 are used by the bootloader firmware.
	System memory	-	4 Kbyte starting from address 0x1FF00000 contain the bootloader firmware.
	IWDG	-	The independent watchdog (IWDG) prescaler is configured to its maximum value and is periodically refreshed to prevent watchdog reset (in case the hardware IWDG option was previously enabled by the user).
	Power	-	Voltage range is set to Voltage Range 1.
USART1 bootloader	USART1	Enabled	Once initialized, the USART1 configuration is: 8 bits, even parity and 1 Stop bit.
	USART1_RX pin	Input	PA10 pin: USART1 in reception mode
	USART1_TX pin	Output	PA9 pin: USART1 in transmission mode
USART2 bootloader	USART2	Enabled	Once initialized, the USART2 configuration is: 8 bits, even parity and 1 Stop bit.
	USART2_RX pin	Input	PD6 pin: USART2 in reception mode
	USART2_TX pin	Output	PD5 pin: USART2 in transmission mode
USARTx bootloaders	SysTick timer	Enabled	Used to automatically detect the serial baud rate from the host.

The system clock is derived from the embedded internal high-speed RC, no external quartz is required for the bootloader execution.

49.2 Bootloader selection

The figure below shows the bootloader selection mechanism.

Figure 66. Bootloader selection for STM32L1xxx6(8/B) devices

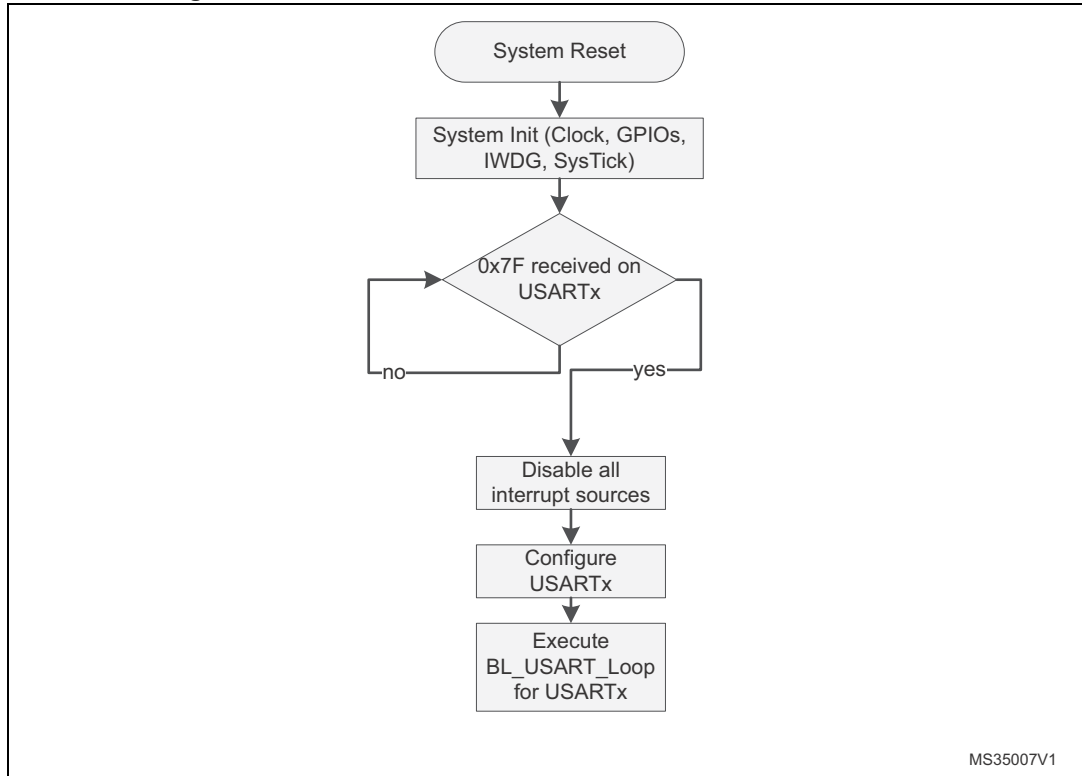

49.3 Bootloader version

The following table lists the STM32L1xxx6(8/B) devices bootloader versions:

Table 105. STM32L1xxx6(8/B) bootloader versions

Bootloader version number	Description	Known limitations
V2.0	Initial bootloader version	When a Read Memory command or Write Memory command is issued with an unsupported memory address and a correct address checksum (ie. address 0x6000 0000), the command is aborted by the bootloader device, but the NACK (0x1F) is not sent to the host. As a result, the next 2 bytes (which are the number of bytes to be read/written and its checksum) are considered as a new command and its checksum. ⁽¹⁾

1. If the “number of data - 1” (N-1) to be read/written is not equal to a valid command code, then the limitation is not perceived from the host since the command is NACKed anyway (as an unsupported new command).

50 STM32L1xxxC devices bootloader

50.1 Bootloader configuration

The STM32L1xxxC bootloader is activated by applying pattern1 (described in [Table 2: Bootloader activation patterns](#)). The following table shows the hardware resources used by this bootloader.

Table 106. STM32L1xxxC configuration in system memory boot mode

Bootloader	Feature/Peripheral	State	Comment
Common to all bootloaders	RCC	HSI enabled	The system clock frequency is 16 MHz using the HSI. This is used only for USARTx bootloaders and during USB detection for DFU bootloader (once the DFU bootloader is selected, the clock source is derived from the external crystal).
		HSE enabled	The external clock is mandatory only for the DFU bootloader and must be in the following range: [24, 16, 12, 8, 6, 4, 3, 2] MHz. The PLL is used to generate the USB 48 MHz clock and the 32 MHz clock for the system clock.
		-	The Clock Security System (CSS) interrupt is enabled for the DFU bootloader. Any failure (or removal) of the external clock generates a system reset.
	RAM	-	4 Kbyte starting from address 0x20000000 are used by the bootloader firmware.
	System memory	-	8 Kbyte starting from address 0x1FF00000 contains the bootloader firmware.
	IWDG	-	The independent watchdog (IWDG) prescaler is configured to its maximum value and is periodically refreshed to prevent watchdog resets (in case the hardware IWDG option was previously enabled by the user).
	Power	-	Voltage range is set to Voltage Range 1.
USART1 bootloader	USART1	Enabled	Once initialized, the USART1 configuration is 8 bits, even parity and 1 stop bit.
	USART1_RX pin	Input	PA10 pin: USART1 in reception mode
	USART1_TX pin	Output	PA9 pin: USART1 in transmission mode
USART2 bootloader	USART2	Enabled	Once initialized, the USART2 configuration is 8 bits, even parity and 1 stop bit. The USART2 uses its remapped pins.
	USART2_RX pin	Input	PD6 pin: USART2 in reception mode
	USART2_TX pin	Output	PD5 pin: USART2 in transmission mode

Table 106. STM32L1xxxC configuration in system memory boot mode (continued)

Bootloader	Feature/Peripheral	State	Comment
USARTx bootloaders	SysTick timer	Enabled	Used to automatically detect the serial baud rate from the host for the USARTx bootloader.
DFU bootloader	USB	Enabled	USB used in FS mode
	USB_DM pin	Input/Output	PA11: USB DM line.
	USB_DP pin		PA12: USB DP line An external pull-up resistor 1.5 KOhm must be connected to USB_DP pin.

The system clock is derived from the embedded internal high-speed RC for the USARTx bootloader. This internal clock is also used for the DFU bootloader but only for the selection phase. An external clock in the range of [24, 16, 12, 8, 6, 4, 3, 2] MHz is required for the execution of the DFU bootloader after the selection phase.

50.2 Bootloader selection

The figure below shows the bootloader selection mechanism.

Figure 67. Bootloader selection for STM32L1xxxC devices

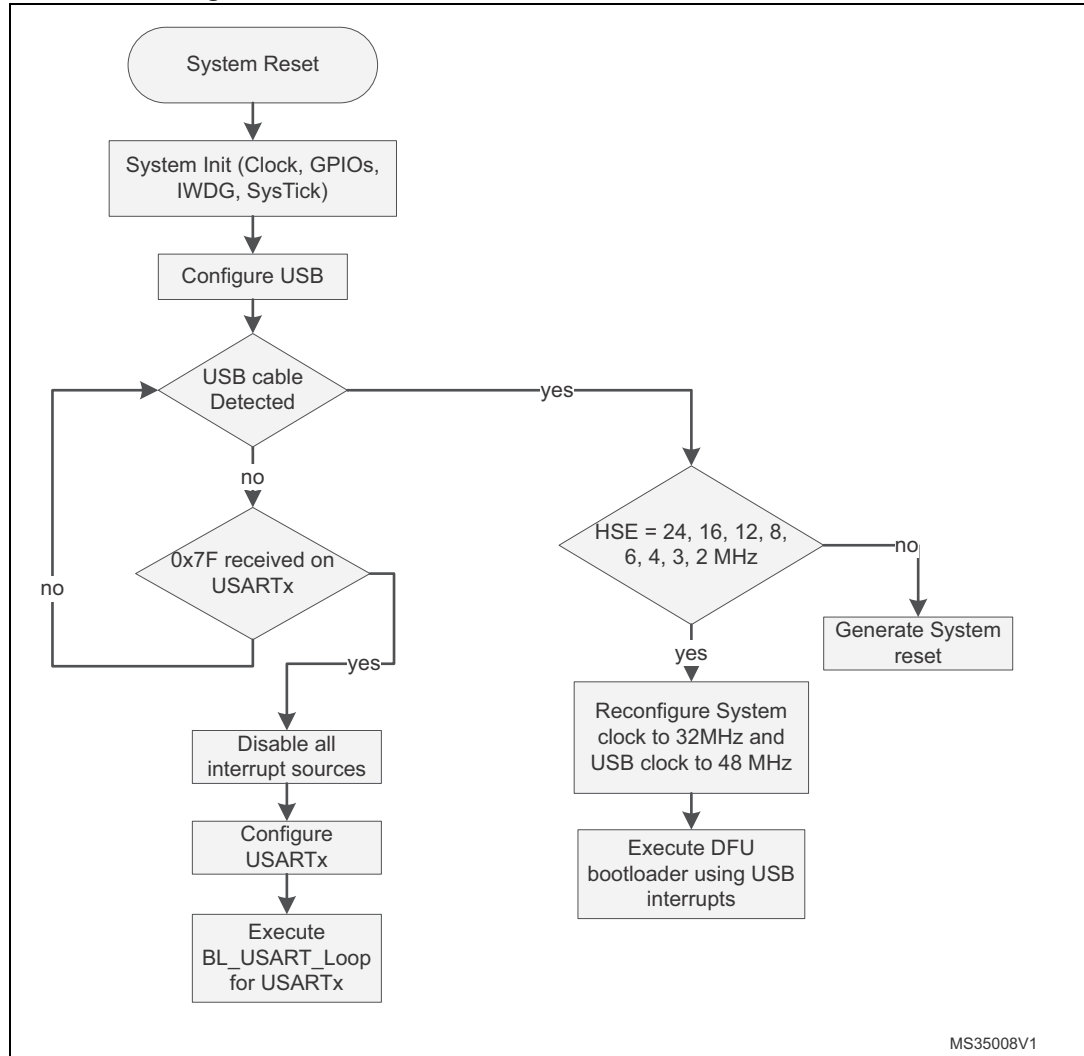

MS35008V1

50.3 Bootloader version

The following table lists the STM32L1xxxC devices bootloader versions:

Table 107. STM32L1xxxC bootloader versions

Bootloader version number	Description	Known limitations
V4.0	Initial bootloader version	For the USART interface, two consecutive NACKs instead of 1 NACK are sent when a Read Memory or Write Memory command is sent and the RDP level is active.

51 STM32L1xxxD devices bootloader

51.1 Bootloader configuration

The STM32L1xxxD bootloader is activated by applying pattern4 (described in [Table 2: Bootloader activation patterns](#)). The following table shows the hardware resources used by this bootloader.

Table 108. STM32L1xxxD configuration in system memory boot mode

Bootloader	Feature/Peripheral	State	Comment
Common to all bootloaders	RCC	HSI enabled	The system clock frequency is 16 MHz using the HSI. This is used only for USARTx bootloaders and during USB detection for DFU bootloader (once the DFU bootloader is selected, the clock source will be derived from the external crystal).
		HSE enabled	The external clock is mandatory only for DFU bootloader and it must be in the following range: [24, 16, 12, 8, 6, 4, 3, 2] MHz. The PLL is used to generate the USB 48 MHz clock and the 32 MHz clock for the system clock.
		-	The Clock Security System (CSS) interrupt is enabled for the DFU bootloader. Any failure (or removal) of the external clock generates system reset.
	RAM	-	4 Kbyte starting from address 0x20000000 are used by the bootloader firmware.
	System memory	-	8 Kbyte starting from address 0x1FF00000 contains the bootloader firmware.
	IWDG	-	The independent watchdog (IWDG) prescaler is configured to its maximum value and is periodically refreshed to prevent watchdog reset (in case the hardware IWDG option was previously enabled by the user).
	Power	-	Voltage range is set to Voltage Range 1.
USART1 bootloader	USART1	Enabled	Once initialized, the USART1 configuration is: 8 bits, even parity and 1 Stop bit.
	USART1_RX pin	Input	PA10 pin: USART1 in reception mode
	USART1_TX pin	Output	PA9 pin: USART1 in transmission mode

Table 108. STM32L1xxxD configuration in system memory boot mode (continued)

Bootloader	Feature/Peripheral	State	Comment
USART2 bootloader	USART2	Enabled	Once initialized, the USART2 configuration is: 8 bits, even parity and 1 Stop bit. The USART2 uses its remapped pins.
	USART2_RX pin	Input	PD6 pin: USART2 in reception mode
	USART2_TX pin	Output	PD5 pin: USART2 in transmission mode
USARTx bootloaders	SysTick timer	Enabled	Used to automatically detect the serial baud rate from the host for USARTx bootloader.
DFU bootloader	USB	Enabled	USB used in FS mode
	USB_DM pin	Input/Output	PA11: USB DM line.
	USB_DP pin		PA12: USB DP line An external pull-up resistor 1.5 KOhm must be connected to USB_DP pin.

The system clock is derived from the embedded internal high-speed RC for USARTx bootloader. This internal clock is used also for DFU bootloader but only for the selection phase. An external clock in the range of [24, 16, 12, 8, 6, 4, 3, 2] MHz is required for DFU bootloader execution after the selection phase.

51.2 Bootloader selection

The figure below shows the bootloader selection mechanism.

Figure 68. Bootloader selection for STM32L1xxxD devices

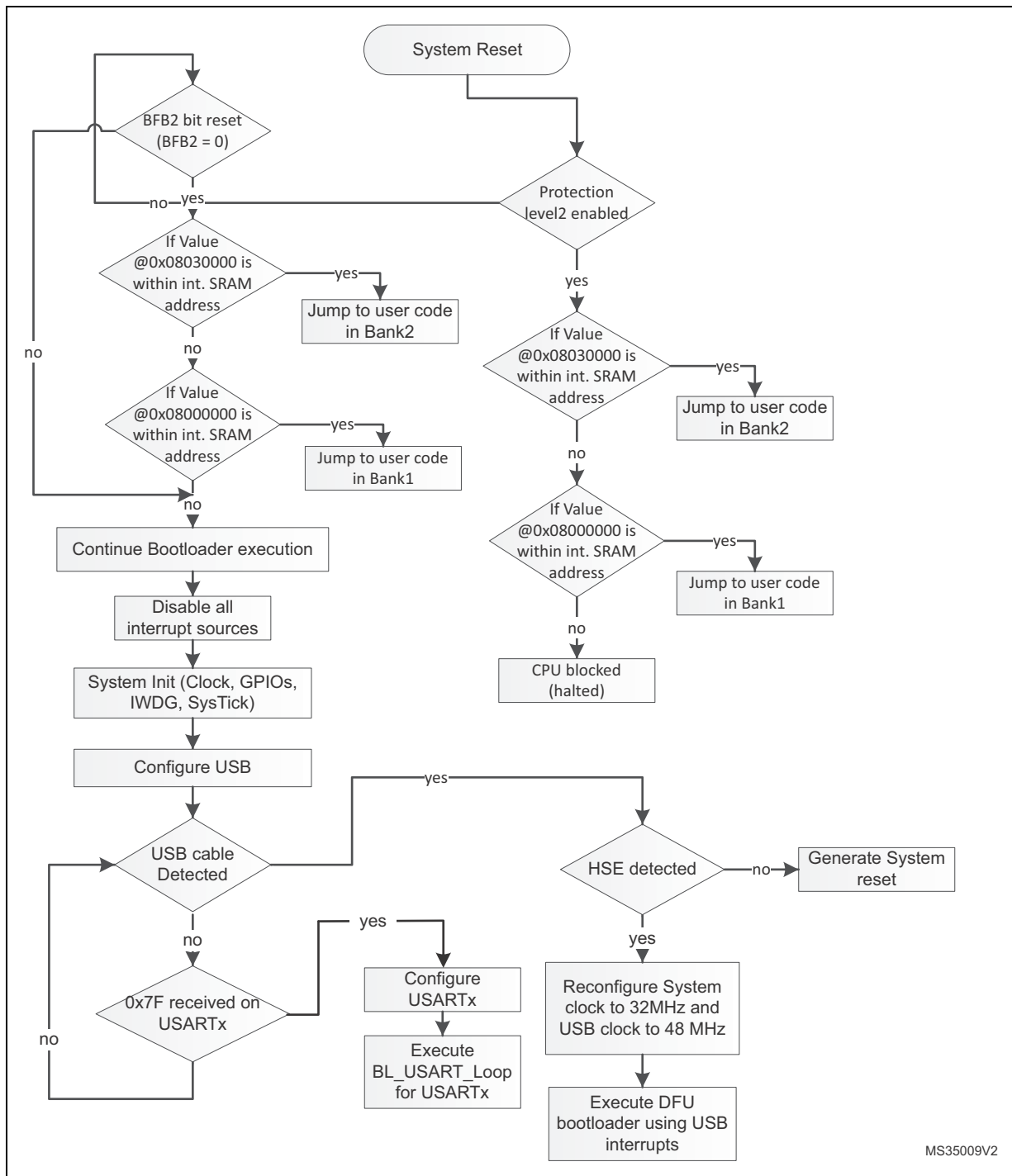

MS35009V2

51.3 Bootloader version

The following table lists the STM32L1xxxD devices bootloader versions:

Table 109. STM32L1xxxD bootloader versions

Bootloader version number	Description	Known limitations
V4.1	Initial bootloader version	<ul style="list-style-type: none"> - In the bootloader code the PA13 (JTMS/SWDIO) I/O output speed is configured to 400 KHz, as consequence some debugger can not connect to the device in Serial Wire mode when the bootloader is running. - When the DFU bootloader is selected, the RTC is reset and thus all RTC information (calendar, alarm, ...) will be lost including backup registers. Note: When the USART bootloader is selected there is no change on the RTC configuration (including backup registers).
V4.2	Fix V4.1 limitations (available on Rev.Z devices only.)	<ul style="list-style-type: none"> - Stack overflow by 8 bytes when jumping to Bank1/Bank2 if BFB2=0 or when Read Protection level is set to 2. Workaround: the user code should force in the startup file the top of stack address before to jump to the main program. This can be done in the "Reset_Handler" routine. - When the Stack of the user code is placed outside the SRAM (ie. @ 0x2000C000) the bootloader cannot jump to that user code which is considered invalid. This might happen when using compilers which place the stack at a non-physical address at the top of the SRAM (ie. @ 0x2000C000). Workaround: place manually the stack at a physical address.
V4.5	Fix V4.2 limitations. DFU interface robustness enhancements (available on Rev.Y devices only).	<ul style="list-style-type: none"> - For the USART interface, two consecutive NACKs (instead of 1 NACK) are sent when a Read Memory or Write Memory command is sent and the RDP level is active.

52 STM32L1xxxE devices bootloader

52.1 Bootloader configuration

The STM32L1xxxE bootloader is activated by applying pattern4 (described in [Table 2: Bootloader activation patterns](#)). The following table shows the hardware resources used by this bootloader.

Table 110. STM32L1xxxE configuration in system memory boot mode

Bootloader	Feature/Peripheral	State	Comment
Common to all bootloaders	RCC	HSI enabled	The system clock frequency is 16 MHz using the HSI. This is used only for USARTx bootloaders and during USB detection for DFU bootloader (once the DFU bootloader is selected, the clock source will be derived from the external crystal).
		HSE enabled	The external clock is mandatory only for DFU bootloader and it must be in the following range: [24, 16, 12, 8, 6, 4, 3, 2] MHz. The PLL is used to generate the USB 48 MHz clock and the 32 MHz clock for the system clock.
		-	The Clock Security System (CSS) interrupt is enabled for the DFU bootloader. Any failure (or removal) of the external clock generates system reset.
	RAM	-	4 Kbyte starting from address 0x20000000 are used by the bootloader firmware.
	System memory	-	8 Kbyte starting from address 0x1FF00000 contains the bootloader firmware.
	IWDG	-	The independent watchdog (IWDG) prescaler is configured to its maximum value and is periodically refreshed to prevent watchdog reset (in case the hardware IWDG option was previously enabled by the user).
	Power	-	Voltage range is set to Voltage Range 1.
USART1 bootloader	USART1	Enabled	Once initialized, the USART1 configuration is: 8 bits, even parity and 1 Stop bit.
	USART1_RX pin	Input	PA10 pin: USART1 in reception mode
	USART1_TX pin	Output	PA9 pin: USART1 in transmission mode

Table 110. STM32L1xxxE configuration in system memory boot mode (continued)

Bootloader	Feature/Peripheral	State	Comment
USART2 bootloader	USART2	Enabled	Once initialized, the USART2 configuration is: 8 bits, even parity and 1 Stop bit. The USART2 uses its remapped pins.
	USART2_RX pin	Input	PD6 pin: USART2 in reception mode
	USART2_TX pin	Output	PD5 pin: USART2 in transmission mode
USARTx bootloaders	SysTick timer	Enabled	Used to automatically detect the serial baud rate from the host for USARTx bootloader.
DFU bootloader	USB	Enabled	USB used in FS mode
	USB_DM pin	Input/Output	PA11: USB DM line.
	USB_DP pin		PA12: USB DP line An external pull-up resistor 1.5 KOhm must be connected to USB_DP pin.

The system clock is derived from the embedded internal high-speed RC for USARTx bootloader. This internal clock is used also for DFU bootloader but only for the selection phase. An external clock in the range of [24, 16, 12, 8, 6, 4, 3, 2] MHz is required for DFU bootloader execution after the selection phase.

52.2 Bootloader selection

The figure below shows the bootloader selection mechanism.

Figure 69. Bootloader selection for STM32L1xxxE devices

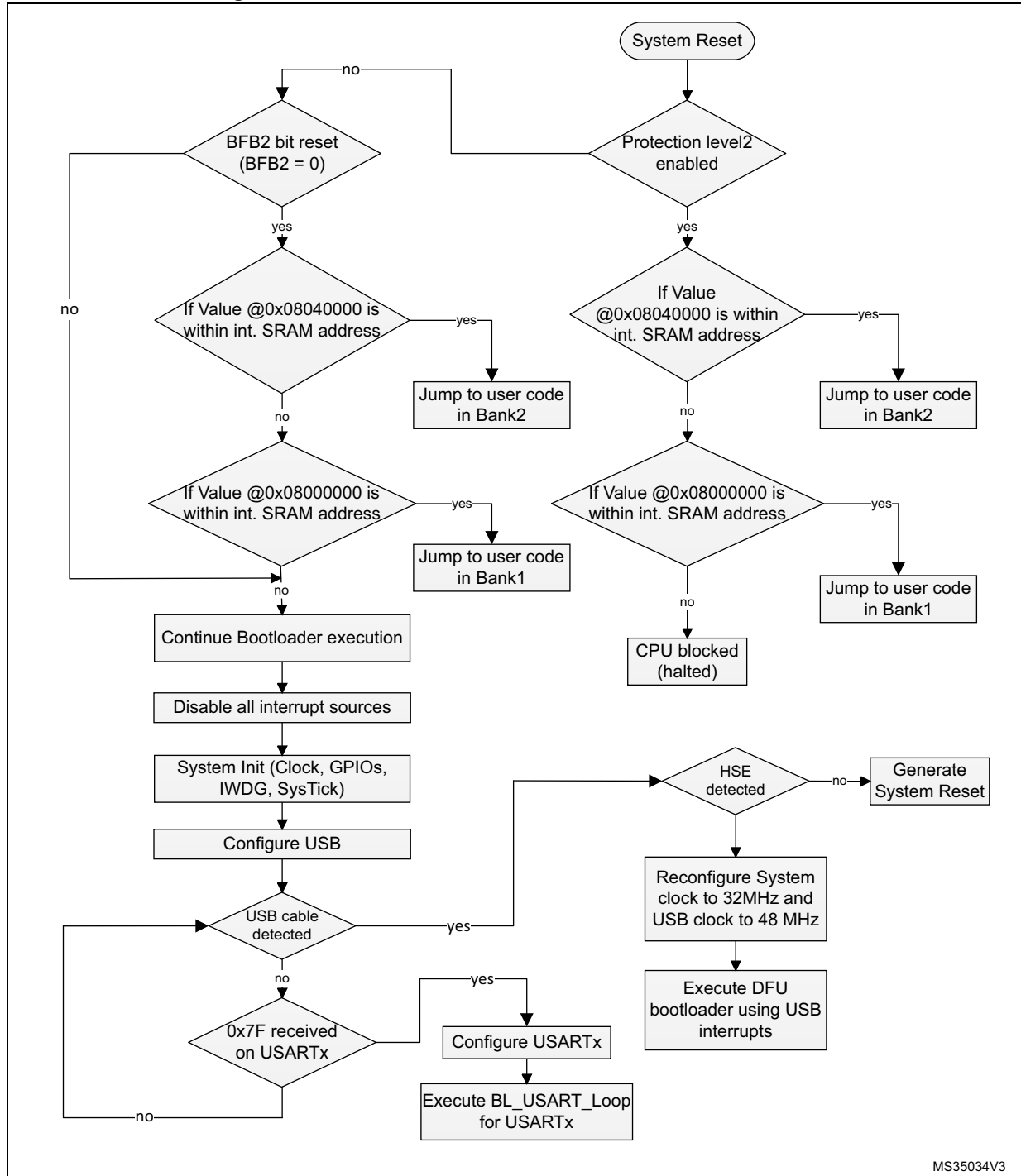

MS35034V3

52.3 Bootloader version

The following table lists the STM32L1xxxE devices bootloader versions:

Table 111. STM32L1xxxE bootloader versions

Bootloader version number	Description	Known limitations
V4.0	Initial bootloader version	For the USART interface, two consecutive NACKs (instead of 1 NACK) are sent when a Read Memory or Write Memory command is sent and the RDP level is active.

53 STM32L412xx/422xx devices bootloader

53.1 Bootloader configuration

The STM32L412xx/422xx bootloader is activated by applying pattern6 (described in [Table 2: Bootloader activation patterns](#)). The following table shows the hardware resources used by this bootloader.

Table 112. STM32L412xx/422xx configuration in system memory boot mode

Bootloader	Feature/Peripheral	State	Comment
Common to all bootloaders	RCC	HSI enabled	The HSI is used at startup as clock source for system clock configured to 72 MHz and for USART, I2C, SPI and USB bootloader operation.
		-	The clock recovery system (CRS) is enabled for the DFU bootloader to allow USB to be clocked by HSI48 48 MHz.
	RAM	-	12 Kbyte starting from address 0x20000000 are used by the bootloader firmware
	System memory	-	28 Kbyte starting from address 0x1FFF0000, contain the bootloader firmware
	IWDG	-	The independent watchdog (IWDG) prescaler is configured to its maximum value. It is periodically refreshed to prevent watchdog reset (in case the hardware IWDG option was previously enabled by the user).
	Power	-	The DFU can't be used to communicate with bootloader if the voltage scaling range 2 is selected. Bootloader firmware doesn't configure voltage scaling range value in PWR_CR1 register.
USART1 bootloader	USART1	Enabled	Once initialized the USART1 configuration is: 8-bits, even parity and 1 Stop bit
	USART1_RX pin	Input	PA10 pin: USART1 in reception mode
	USART1_TX pin	Output	PA9 pin: USART1 in transmission mode
USART2 bootloader	USART2	Enabled	Once initialized the USART2 configuration is: 8-bits, even parity and 1 Stop bit
	USART2_RX pin	Input	PA3 pin: USART2 in reception mode
	USART2_TX pin	Output	PA2 pin: USART2 in transmission mode
USART3 bootloader	USART3	Enabled	Once initialized the USART3 configuration is: 8-bits, even parity and 1 Stop bit
	USART3_RX pin	Input	PC11 pin: USART3 in reception mode
	USART3_TX pin	Output	PC10 pin: USART3 in transmission mode
USARTx bootloaders	SysTick timer	Enabled	Used to automatically detect the serial baud rate from the host for USARTx bootloaders.

Table 112. STM32L412xx/422xx configuration in system memory boot mode (continued)

Bootloader	Feature/Peripheral	State	Comment
I2C1 bootloader	I2C1	Enabled	The I2C1 configuration is: I2C speed: up to 1 MHz, 7-bit address, slave mode, analog filter ON. Slave 7-bit address: 0b1010010x (where x = 0 for write and x = 1 for read)
	I2C1_SCL pin	Input/Output	PB6 pin: clock line is used in open-drain mode.
	I2C1_SDA pin	Input/Output	PB7 pin: data line is used in open-drain mode.
I2C2 bootloader	I2C2	Enabled	The I2C2 configuration is: I2C speed: up to 1 MHz, 7-bit address, slave mode, analog filter ON. Slave 7-bit address: 0b1010010x (where x = 0 for write and x = 1 for read)
	I2C2_SCL pin	Input/Output	PB10 pin: clock line is used in open-drain mode.
	I2C2_SDA pin	Input/Output	PB11 pin: data line is used in open-drain mode.
I2C3 bootloader	I2C3	Enabled	The I2C3 configuration is: I2C speed: up to 1 MHz, 7-bit address, slave mode, analog filter ON. Slave 7-bit address: 0b1010010x (where x = 0 for write and x = 1 for read)
	I2C3_SCL pin	Input/Output	PC0 pin: clock line is used in open-drain mode.
	I2C3_SDA pin	Input/Output	PC1 pin: data line is used in open-drain mode.
SPI1 bootloader	SPI1	Enabled	The SPI1 configuration is: – Slave mode – Full Duplex – 8-bit MSB – Speed up to 8 MHz – Polarity: CPOL Low, CPHA Low, NSS hardware.
	SPI1_MOSI pin	Input	PA7 pin: Slave data Input line, used in push-pull pull-down mode
	SPI1_MISO pin	Output	PA6 pin: Slave data output line, used in push-pull pull-down mode
	SPI1_SCK pin	Input	PA5 pin: Slave clock line, used in push-pull pull-down mode
	SPI1_NSS pin	Input	PA4 pin: slave chip select pin used in push-pull pull-up mode. Note: This IO can be tied to Gnd if the SPI Master does not use it.

Table 112. STM32L412xx/422xx configuration in system memory boot mode (continued)

Bootloader	Feature/Peripheral	State	Comment
SPI2 bootloader	SPI2	Enabled	The SPI2 configuration is: – Slave mode – Full Duplex – 8-bit MSB – Speed up to 8 MHz Polarity: CPOL Low, CPHA Low, NSS hardware
	SPI2_MOSI pin	Input	PB15 pin: Slave data Input line, used in push-pull pull-down mode
	SPI2_MISO pin	Output	PB14 pin: Slave data output line, used in push-pull pull-down mode
	SPI2_SCK pin	Input	PB13 pin: Slave clock line, used in push-pull pull-down mode
	SPI2_NSS pin	Input	PB12 pin: slave chip select pin used in push-pull pull-up mode. Note: This IO can be tied to Gnd if the SPI Master does not use it.
DFU bootloader	USB	Enabled	USB FS configured in forced device mode. USB FS interrupt vector is enabled and used for USB DFU communications. Note: VDDUSB IO must be connected to 3.3V for USB to be operational.
	USB_DM pin	Input/Output	PA11: USB DM line.
	USB_DP pin		PA12: USB DP line No external Pull-up resistor is required

53.2 Bootloader selection

The figure below shows the bootloader selection mechanism.

Figure 70.Bootloader V13.x selection for STM32L412xx/422xx

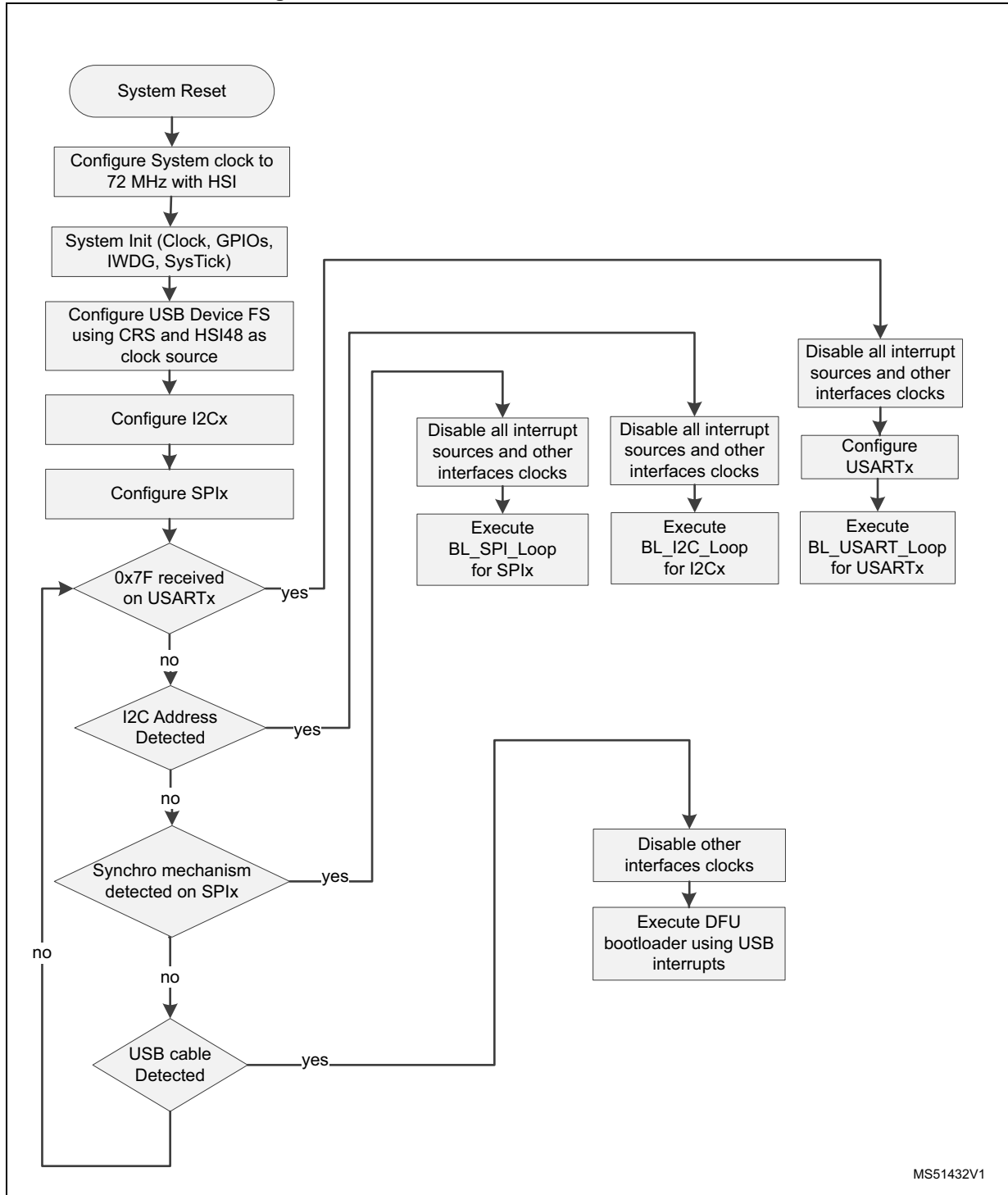

MS51432V1

53.3 Bootloader version

The [Table 113](#) lists the STM32L412xx/422xx devices bootloader version.

Table 113. STM32L412xx/422xx bootloader versions

Bootloader version number	Description	Known limitations
V13.1	Initial bootloader version	<ul style="list-style-type: none">– On connection phase, USART responds with two ACK bytes (0x79) instead of only one.– PcROP option bytes cannot be written as Bootloader uses Byte access while PcROP must be accessed using Half-Word access. Workaround: load a code snippet in SRAM using Bootloader interface then jump to it, and that code would write PcROP value.

54 STM32L43xxx/44xxx devices bootloader

54.1 Bootloader configuration

The bootloader V9.1 version is updated to fix known limitations relative to USB-DFU interface, and is implemented on devices with version information ID equal to 0x10 (refer to [Table 115](#) for more details).

The STM32L43xxx/44xxx bootloader is activated by applying pattern6 (described in [Table 2: Bootloader activation patterns](#)). The following table shows the hardware resources used by this bootloader.

Table 114. STM32L43xxx/44xxx configuration in system memory boot mode

Bootloader	Feature/Peripheral	State	Comment
Common to all bootloaders	RCC	HSI enabled	The HSI is used at startup as clock source for system clock configured to 60 MHz and for USART, I2C, SPI and USB bootloader operation.
		-	The clock recovery system (CRS) is enabled for the DFU bootloader to allow USB to be clocked by HSI48 48 MHz.
		HSE enabled	The HSE is used only when the CAN interface is selected. The HSE must have one of the following values [24,20,18,16,12,9,8,6,4] MHz.
		-	The Clock Security System (CSS) interrupt is enabled when HSE is enabled. Any failure (or removal) of the external clock generates system reset
	RAM	-	12 Kbyte starting from address 0x20000000 are used by the bootloader firmware
	System memory	-	28 Kbyte starting from address 0x1FFF0000, contain the bootloader firmware
	IWDG	-	The independent watchdog (IWDG) prescaler is configured to its maximum value. It is periodically refreshed to prevent watchdog reset (in case the hardware IWDG option was previously enabled by the user).
	Power	-	The DFU can't be used to communicate with bootloader if the voltage scaling range 2 is selected. Bootloader firmware doesn't configure voltage scaling range value in PWR_CR1 register.
USART1 bootloader	USART1	Enabled	Once initialized the USART1 configuration is: 8-bits, even parity and 1 Stop bit
	USART1_RX pin	Input	PA10 pin: USART1 in reception mode
	USART1_TX pin	Output	PA9 pin: USART1 in transmission mode

Table 114. STM32L43xxx/44xxx configuration in system memory boot mode (continued)

Bootloader	Feature/Peripheral	State	Comment
USART2 bootloader	USART2	Enabled	Once initialized the USART2 configuration is: 8-bits, even parity and 1 Stop bit
	USART2_RX pin	Input	PA3 pin: USART2 in reception mode
	USART2_TX pin	Output	PA2 pin: USART2 in transmission mode
USART3 bootloader	USART3	Enabled	Once initialized the USART3 configuration is: 8-bits, even parity and 1 Stop bit
	USART3_RX pin	Input	PC11 pin: USART3 in reception mode
	USART3_TX pin	Output	PC10 pin: USART3 in transmission mode
USARTx bootloaders	SysTick timer	Enabled	Used to automatically detect the serial baud rate from the host for USARTx bootloaders.
I2C1 bootloader	I2C1	Enabled	The I2C1 configuration is: I2C speed: up to 1 MHz, 7-bit address, slave mode, analog filter ON. Slave 7-bit address: 0b1001000x (where x = 0 for write and x = 1 for read)
	I2C1_SCL pin	Input/Output	PB6 pin: clock line is used in open-drain mode.
	I2C1_SDA pin	Input/Output	PB7 pin: data line is used in open-drain mode.
I2C2 bootloader	I2C2	Enabled	The I2C2 configuration is: I2C speed: up to 1 MHz, 7-bit address, slave mode, analog filter ON. Slave 7-bit address: 0b1001000x (where x = 0 for write and x = 1 for read)
	I2C2_SCL pin	Input/Output	PB10 pin: clock line is used in open-drain mode.
	I2C2_SDA pin	Input/Output	PB11 pin: data line is used in open-drain mode.
I2C3 bootloader	I2C3	Enabled	The I2C3 configuration is: I2C speed: up to 1 MHz, 7-bit address, slave mode, analog filter ON. Slave 7-bit address: 0b1001000x (where x = 0 for write and x = 1 for read)
	I2C3_SCL pin	Input/Output	PC0 pin: clock line is used in open-drain mode.
	I2C3_SDA pin	Input/Output	PC1 pin: data line is used in open-drain mode.

Table 114. STM32L43xxx/44xxx configuration in system memory boot mode (continued)

Bootloader	Feature/Peripheral	State	Comment
SPI1 bootloader	SPI1	Enabled	The SPI1 configuration is: – Slave mode – Full Duplex – 8-bit MSB – Speed up to 8 MHz – Polarity: CPOL Low, CPHA Low, NSS hardware.
	SPI1_MOSI pin	Input	PA7 pin: Slave data Input line, used in push-pull pull-down mode
	SPI1_MISO pin	Output	PA6 pin: Slave data output line, used in push-pull pull-down mode
	SPI1_SCK pin	Input	PA5 pin: Slave clock line, used in push-pull pull-down mode
	SPI1_NSS pin	Input	PA4 pin: slave chip select pin used in push-pull pull-down mode. Note: This IO can be tied to Gnd if the SPI Master does not use it.
SPI2 bootloader	SPI2	Enabled	The SPI2 configuration is: – Slave mode – Full Duplex – 8-bit MSB – Speed up to 8 MHz Polarity: CPOL Low, CPHA Low, NSS hardware
	SPI2_MOSI pin	Input	PB15 pin: Slave data Input line, used in push-pull pull-down mode
	SPI2_MISO pin	Output	PB14 pin: Slave data output line, used in push-pull pull-down mode
	SPI2_SCK pin	Input	PB13 pin: Slave clock line, used in push-pull pull-down mode
	SPI2_NSS pin	Input	PB12 pin: slave chip select pin used in push-pull pull-down mode. Note: This IO can be tied to Gnd if the SPI Master does not use it.
CAN1 bootloader	CAN1	Enabled	Once initialized the CAN1 configuration is: Baudrate 125 kbps, 11 -bit identifier.
	CAN1_RX pin	Input	PB8 pin: CAN1 in reception mode
	CAN1_TX pin	Output	PB9 pin: CAN1 in transmission mode
	TIM16	Enabled	This timer is used to determine the value of the HSE. Once the HSE frequency is determined, the system clock is configured to 60 MHz using PLL and HSE.

Table 114. STM32L43xxx/44xxx configuration in system memory boot mode (continued)

Bootloader	Feature/Peripheral	State	Comment
DFU bootloader	USB	Enabled	USB FS configured in forced device mode. USB FS interrupt vector is enabled and used for USB DFU communications. Note: VDDUSB IO must be connected to 3.3V for USB to be operational.
	USB_DM pin	Input/Output	PA11: USB DM line.
	USB_DP pin		PA12: USB DP line No external Pull-up resistor is required

54.2 Bootloader selection

The figure below shows the bootloader selection mechanism.

Figure 71. Bootloader V9.x selection for STM32L43xxx/44xxx

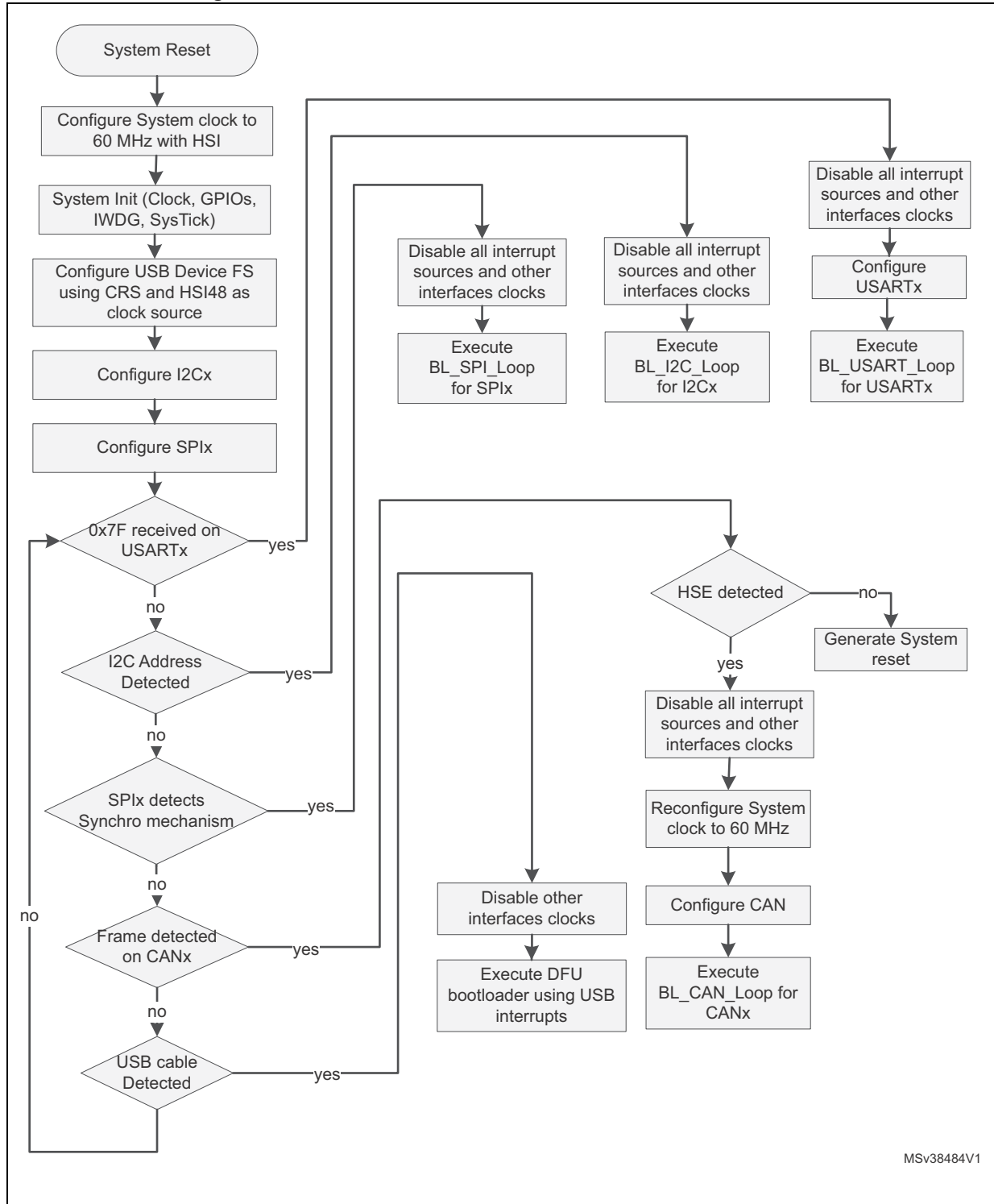

MSv38484V1

54.3 Bootloader version

The [Table 115](#) lists the STM32L43xxx/44xxx devices bootloader versions.

Table 115. STM32L43xxx/44xxx bootloader versions

Bootloader version number	Description	Known limitations
V9.1	Initial bootloader version	<p>Check the Version Information ID of your STM32L43xxx/44xxx device, which can be read at 0x1FFF6FF2 address.</p> <p>Version Information ID equal to 0xFF:</p> <ul style="list-style-type: none"> – For memory write operations using DFU interface: If the buffer size is larger than 256 bytes and not multiple of 8 bytes, the write memory operation result is corrupted. Workaround: if the file size is larger than 256 bytes, add byte padding to align it on 8-bytes multiple size. – For the USB-DFU interface, the CRS (clock recovery system) is not correctly configured and this may lead to random USB communication errors (depending on temperature and voltage). In most case communication error will manifest by a "Stall" response to setup packets. – On the "Go" command, system bootloader de-init clears the RTCAPBEN bit in the RCC_APB1ENR register Workaround: manually call <code>__HAL_RCC_RTC_CLK_ENABLE()</code> in the software which sets the RTCAPBEN bit. <p>Version Information ID equal to 0x10: None</p> <ul style="list-style-type: none"> – PcROP option bytes cannot be written as Bootloader uses Byte access while PcROP must be accessed using Half-Word access. Workaround: load a code snippet in SRAM using Bootloader interface then jump to it, and that code would write PcROP value.

55 STM32L45xxx/46xxx devices bootloader

55.1 Bootloader configuration

The STM32L45xxx/46xxx bootloader is activated by applying pattern6 (described in [Table 2: Bootloader activation patterns](#)). The following table shows the hardware resources used by this bootloader.

Table 116. STM32L45xxx/46xxx configuration in system memory boot mode

Bootloader	Feature/Peripheral	State	Comment
Common to all bootloaders	RCC	HSI enabled	The HSI is used at startup as clock source for system clock configured to 72 MHz and for USART, I2C, SPI and USB bootloader operation.
		-	The clock recovery system (CRS) is enabled for the DFU bootloader to allow USB to be clocked by HSI48 48 MHz.
		HSE enabled	The system clock frequency is 60 MHz. The HSE is used only when the CAN interface is selected . The HSE must have one of the following values [24,20,18,16,12,9,8,6,4] MHz.
		-	The Clock Security System (CSS) interrupt is enabled when HSE is enabled. Any failure (or removal) of the external clock generates system reset
	RAM	-	12 Kbyte starting from address 0x20000000 are used by the bootloader firmware
	System memory	-	28 Kbyte starting from address 0x1FFF0000, contain the bootloader firmware
	IWDG	-	The independent watchdog (IWDG) prescaler is configured to its maximum value. It is periodically refreshed to prevent watchdog reset (in case the hardware IWDG option was previously enabled by the user).
Power	-	The DFU can't be used to communicate with bootloader if the voltage scaling range 2 is selected. Bootloader firmware doesn't configure voltage scaling range value in PWR_CR1 register.	
USART1 bootloader	USART1	Enabled	Once initialized the USART1 configuration is: 8-bits, even parity and 1 Stop bit
	USART1_RX pin	Input	PA10 pin: USART1 in reception mode
	USART1_TX pin	Output	PA9 pin: USART1 in transmission mode

Table 116. STM32L45xxx/46xxx configuration in system memory boot mode (continued)

Bootloader	Feature/Peripheral	State	Comment
USART2 bootloader	USART2	Enabled	Once initialized the USART2 configuration is: 8-bits, even parity and 1 Stop bit
	USART2_RX pin	Input	PA3 pin: USART2 in reception mode
	USART2_TX pin	Output	PA2 pin: USART2 in transmission mode
USART3 bootloader	USART3	Enabled	Once initialized the USART3 configuration is: 8-bits, even parity and 1 Stop bit
	USART3_RX pin	Input	PC11 pin: USART3 in reception mode
	USART3_TX pin	Output	PC10 pin: USART3 in transmission mode
USARTx bootloaders	SysTick timer	Enabled	Used to automatically detect the serial baud rate from the host for USARTx bootloaders.
I2C1 bootloader	I2C1	Enabled	The I2C1 configuration is: I2C speed: up to 1 MHz, 7-bit address, slave mode, analog filter ON. Slave 7-bit address: 0b1001010x (where x = 0 for write and x = 1 for read)
	I2C1_SCL pin	Input/Output	PB6 pin: clock line is used in open-drain mode.
	I2C1_SDA pin	Input/Output	PB7 pin: data line is used in open-drain mode.
I2C2 bootloader	I2C2	Enabled	The I2C2 configuration is: I2C speed: up to 1 MHz, 7-bit address, slave mode, analog filter ON. Slave 7-bit address: 0b1001010x (where x = 0 for write and x = 1 for read)
	I2C2_SCL pin	Input/Output	PB10 pin: clock line is used in open-drain mode.
	I2C2_SDA pin	Input/Output	PB11 pin: data line is used in open-drain mode.
I2C3 bootloader	I2C3	Enabled	The I2C3 configuration is: I2C speed: up to 1 MHz, 7-bit address, slave mode, analog filter ON. Slave 7-bit address: 0b1001010x (where x = 0 for write and x = 1 for read)
	I2C3_SCL pin	Input/Output	PC0 pin: clock line is used in open-drain mode.
	I2C3_SDA pin	Input/Output	PC1 pin: data line is used in open-drain mode.

Table 116. STM32L45xxx/46xxx configuration in system memory boot mode (continued)

Bootloader	Feature/Peripheral	State	Comment
SPI1 bootloader	SPI1	Enabled	The SPI1 configuration is: – Slave mode – Full Duplex – 8-bit MSB – Speed up to 8 MHz – Polarity: CPOL Low, CPHA Low, NSS hardware.
	SPI1_MOSI pin	Input	PA7 pin: Slave data Input line, used in push-pull pull-down mode
	SPI1_MISO pin	Output	PA6 pin: Slave data output line, used in push-pull pull-down mode
	SPI1_SCK pin	Input	PA5 pin: Slave clock line, used in push-pull pull-down mode
	SPI1_NSS pin	Input	PA4 pin: slave chip select pin used in push-pull pull-down mode. Note: This IO can be tied to Gnd if the SPI Master does not use it.
SPI2 bootloader	SPI2	Enabled	The SPI2 configuration is: – Slave mode – Full Duplex – 8-bit MSB – Speed up to 8 MHz – Polarity: CPOL Low, CPHA Low, NSS hardware.
	SPI2_MOSI pin	Input	PB15 pin: Slave data Input line, used in push-pull pull-down mode
	SPI2_MISO pin	Output	PB14 pin: Slave data output line, used in push-pull pull-down mode
	SPI2_SCK pin	Input	PB13 pin: Slave clock line, used in push-pull pull-down mode
	SPI2_NSS pin	Input	PB12 pin: slave chip select pin used in push-pull pull-down mode. Note: This IO can be tied to Gnd if the SPI Master does not use it.
CAN1 bootloader	CAN1	Enabled	Once initialized the CAN1 configuration is: Baudrate 125 kbps, 11 -bit identifier.
	CAN1_RX pin	Input	PB8 pin: CAN1 in reception mode
	CAN1_TX pin	Output	PB9 pin: CAN1 in transmission mode
	TIM16	Enabled	This timer is used to determine the value of the HSE. Once the HSE frequency is determined, the system clock is configured to 60 MHz using PLL and HSE.

Table 116. STM32L45xxx/46xxx configuration in system memory boot mode (continued)

Bootloader	Feature/Peripheral	State	Comment
DFU bootloader	USB	Enabled	USB FS configured in forced device mode. USB FS interrupt vector is enabled and used for USB DFU communications. Note: VDDUSB IO must be connected to 3.3V for USB to be operational.
	USB_DM pin	Input/Output	PA11: USB DM line.
	USB_DP pin		PA12: USB DP line No external Pull-up resistor is required

55.2 Bootloader selection

The figure below shows the bootloader selection mechanism.

Figure 72.Bootloader V9.x selection for STM32L45xxx/46xxx

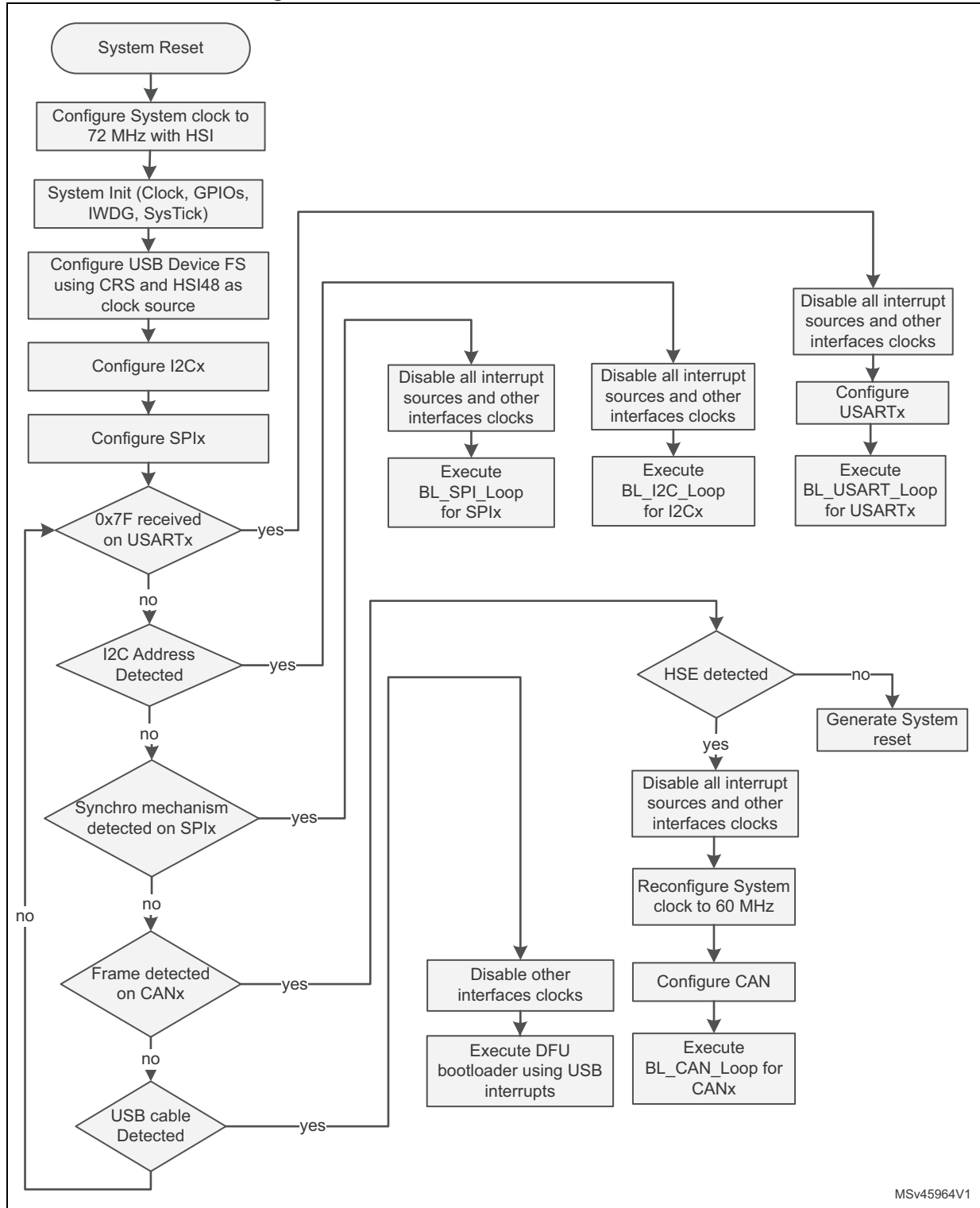

MSv45964V1

55.3 Bootloader version

[Table 117](#) lists the STM32L45xxx/46xxx devices bootloader versions.

Table 117. STM32L45xxx/46xxx bootloader versions

Bootloader version number	Description	Known limitations
V9.2	Initial bootloader version	<ul style="list-style-type: none">– PcROP option bytes cannot be written as Bootloader uses Byte access while PcROP must be accessed using Half-Word access. Workaround: load a code snippet in SRAM using Bootloader interface then jump to it, and that code would write PcROP value.

56 STM32L47xxx/48xxx devices bootloader

Two bootloader versions are available on STM32L47xxx/48xxx:

- V10.x supporting USART, I2C and DFU (USB FS Device).
This version is embedded in STM32L47xxx/48xxx rev. 2 and rev. 3 devices.
- V9.x supporting USART, I2C, SPI, CAN and DFU (USB FS Device).
This version is embedded in STM32L47xxx/48xxx rev. 4 devices.

56.1 Bootloader V10.x

56.1.1 Bootloader configuration

The STM32L47xxx/48xxx bootloader is activated by applying pattern7 (described in [Table 2: Bootloader activation patterns](#)). The following table shows the hardware resources used by this bootloader.

Table 118. STM32L47xxx/48xxx configuration in system memory boot mode

Bootloader	Feature/Peripheral	State	Comment
Common to all bootloaders	RCC	HSI enabled	The HSI is used at startup as clock source for system clock configured to 24 MHz and for USART and I2C bootloader operation.
		HSE enabled	The HSE is used only when the USB interface is selected and the LSE is not present. The HSE must have one of the following values [24,20,18,16,12,9,8,6,4] MHz.
		LSE enabled	The LSE is used to trim the MSI which is configured to 48 MHz as USB clock source. The LSE must be equal to 32,768 KHz. If the LSE is not detected, the HSE will be used instead if USB is connected.
		MSI enabled	The MSI is configured to 48 MHz and will be used as USB clock source. The MSI is used only if LSE is detected, otherwise, HSE will be used if USB is connected.
		-	The Clock Security System (CSS) interrupt is enabled when LSE or HSE is enabled. Any failure (or removal) of the external clock generates system reset.
	RAM	-	12 Kbyte starting from address 0x20000000 are used by the bootloader firmware
	System memory	-	28 Kbyte starting from address 0x1FFF0000, contain the bootloader firmware
	IWDG	-	The independent watchdog (IWDG) prescaler is configured to its maximum value. It is periodically refreshed to prevent watchdog reset (in case the hardware IWDG option was previously enabled by the user).
	Power	-	The DFU can't be used to communicate with bootloader if the voltage scaling range 2 is selected. Bootloader firmware doesn't configure voltage scaling range value in PWR_CR1 register.

Table 118. STM32L47xxx/48xxx configuration in system memory boot mode (continued)

Bootloader	Feature/Peripheral	State	Comment
USART1 bootloader	USART1	Enabled	Once initialized the USART1 configuration is: 8-bits, even parity and 1 Stop bit
	USART1_RX pin	Input	PA10 pin: USART1 in reception mode
	USART1_TX pin	Output	PA9 pin: USART1 in transmission mode
USART2 bootloader	USART2	Enabled	Once initialized the USART2 configuration is: 8-bits, even parity and 1 Stop bit
	USART2_RX pin	Input	PA3 pin: USART2 in reception mode
	USART2_TX pin	Output	PA2 pin: USART2 in transmission mode
USART3 bootloader	USART3	Enabled	Once initialized the USART3 configuration is: 8-bits, even parity and 1 Stop bit
	USART3_RX pin	Input	PC11 pin: USART3 in reception mode
	USART3_TX pin	Output	PC10 pin: USART3 in transmission mode
USARTx bootloaders	SysTick timer	Enabled	Used to automatically detect the serial baud rate from the host for USARTx bootloaders.
I2C1 bootloader	I2C1	Enabled	The I2C1 configuration is: I2C speed: up to 400 KHz, 7-bit address, slave mode, analog filter ON. Slave 7-bit address: 0b1000011x (where x = 0 for write and x = 1 for read)
	I2C1_SCL pin	Input/Output	PB6 pin: clock line is used in open-drain mode.
	I2C1_SDA pin	Input/Output	PB7 pin: data line is used in open-drain mode.
I2C2 bootloader	I2C2	Enabled	The I2C2 configuration is: I2C speed: up to 400 KHz, 7-bit address, slave mode, analog filter ON. Slave 7-bit address: 0b1000011x (where x = 0 for write and x = 1 for read)
	I2C2_SCL pin	Input/Output	PB10 pin: clock line is used in open-drain mode.
	I2C2_SDA pin	Input/Output	PB11 pin: data line is used in open-drain mode.
I2C3 bootloader	I2C3	Enabled	The I2C3 configuration is: I2C speed: up to 400 KHz, 7-bit address, slave mode, analog filter ON. Slave 7-bit address is 0b1000011x (where x = 0 for write and x = 1 for read)
	I2C3_SCL pin	Input/Output	PC0 pin: clock line is used in open-drain mode.
	I2C3_SDA pin	Input/Output	PC1 pin: data line is used in open-drain mode.
DFU bootloader	USB	Enabled	USB OTG FS configured in forced device mode
	USB_DM pin	Input/Output	PA11: USB DM line.
	USB_DP pin		PA12: USB DP line No external Pull-up resistor is required
	TIM17	Enabled	This timer is used to determine the value of the HSE. Once the HSE frequency is determined, the system clock is configured to 24 MHz using PLL and HSE.

For USARTx and I2Cx bootloaders no external clock is required.

USB bootloader (DFU) requires either an LSE (low-speed external clock) or a HSE (high-speed external clock) :

- In case, the LSE is present regardless the HSE presence, the MSI will be configured and trimmed by the LSE to provide an accurate clock equal to 48 MHz which is the clock source of the USB. The system clock is kept clocked to 24 MHz by the HSI.
- In case, the HSE is present, the system clock and USB clock will be configured respectively to 24 MHz and 48 MHz with HSE as clock source.

56.1.2 Bootloader selection

The [Figure 73](#) and [Figure 74](#) show the bootloader selection mechanism.

Figure 73. Dual Bank Boot Implementation for STM32L47xxx/48xxx bootloader V10.x

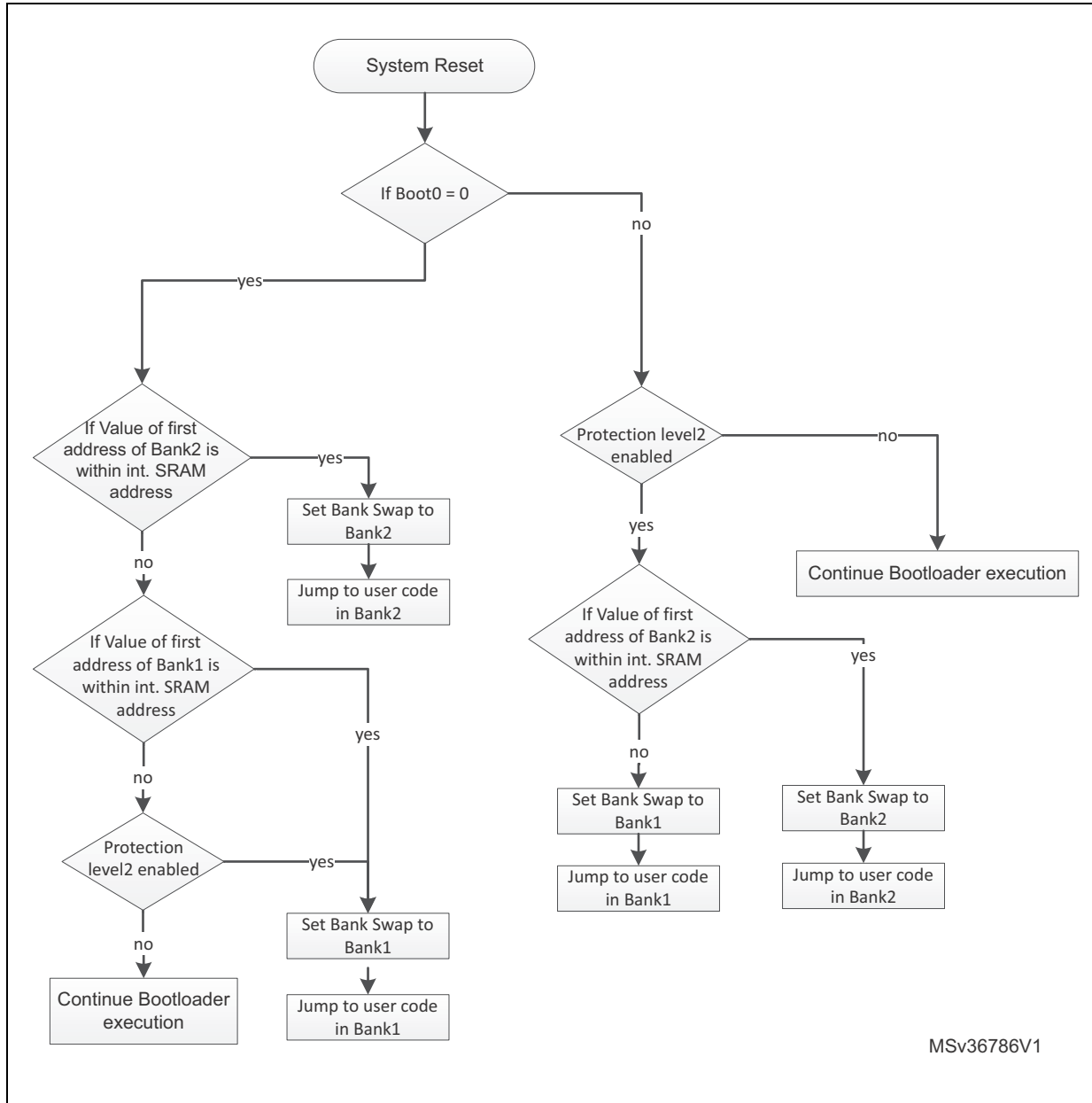
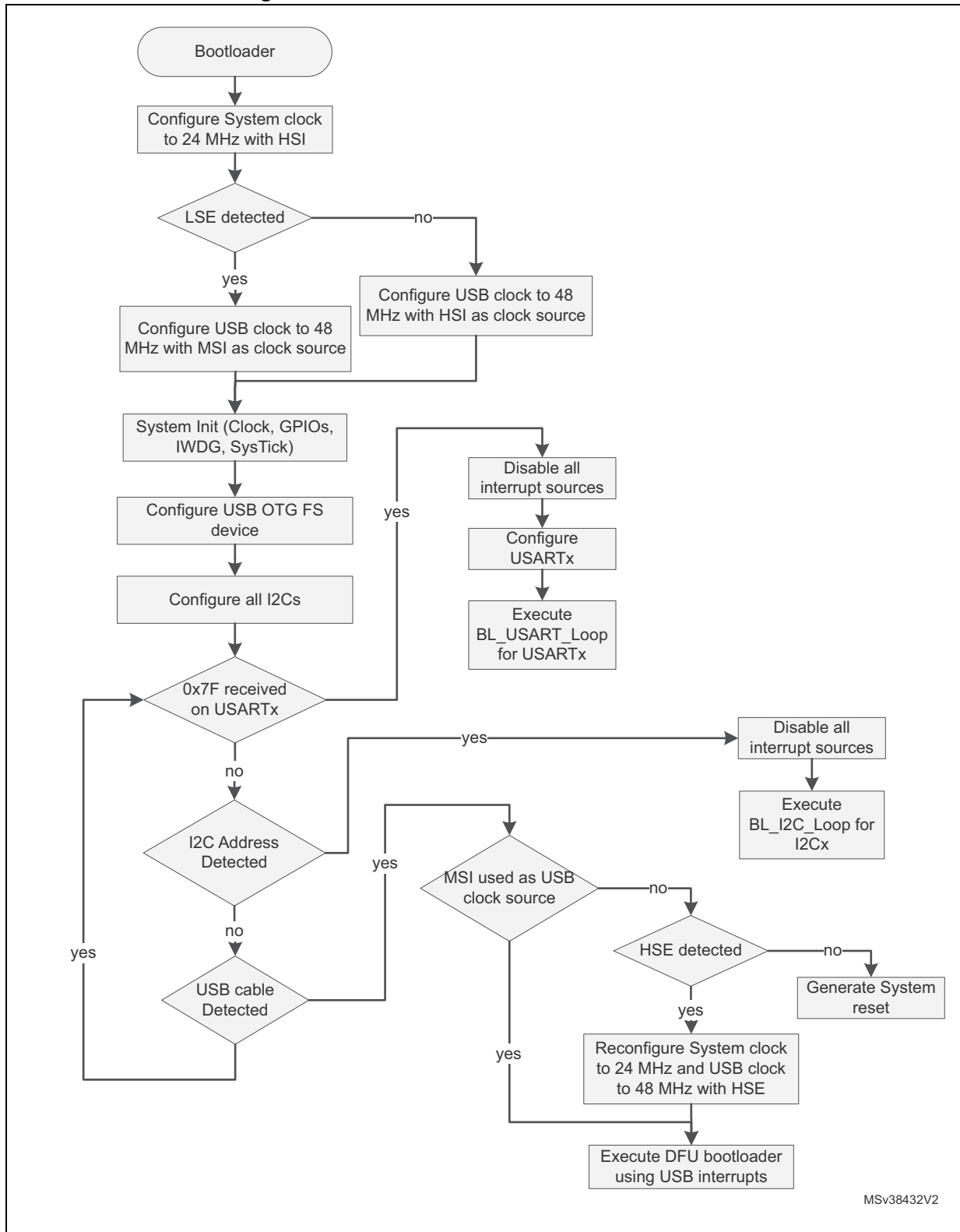

Figure 74.Bootloader V10.x selection for STM32L47xxx/48xxx



MSv38432V2

56.1.3 Bootloader version

The following table lists the STM32L47xxx/48xxx devices bootloader V10.x versions:

Table 119. STM32L47xxx/48xxx bootloader V10.x versions

Bootloader version number	Description	Known limitations
V10.1	Initial bootloader version	For memory write operations using DFU interface: If the buffer size is larger than 256 bytes and not multiple of 8 bytes, the write memory operation result is corrupted. Workaround: if the file size is larger than 256 bytes, add byte padding to align it on 8-bytes multiple size. Write in SRAM is corrupted.
V10.2	Fix write in SRAM issue	For memory write operations using DFU interface: If the buffer size is larger than 256 bytes and not multiple of 8 bytes, the write memory operation result is corrupted. Workaround: if the file size is larger than 256 bytes, add byte padding to align it on 8-bytes multiple size.
V10.3	Add support of MSI as USB clock source (MSI is trimmed by LSE). Update dual bank boot feature to support the case when user stack is mapped in SRAM2.	<ul style="list-style-type: none"> – For memory write operations using DFU interface: If the buffer size is larger than 256 bytes and not multiple of 8 bytes, the write memory operation result is corrupted. Workaround: if the file size is larger than 256 bytes, add byte padding to align it on 8-bytes multiple size. – PcROP option bytes cannot be written as Bootloader uses Byte access while PcROP must be accessed using Half-Word access. Workaround: load a code snippet in SRAM using Bootloader interface then jump to it, and that code would write PcROP value.

56.2 Bootloader V9.x

56.2.1 Bootloader configuration

The STM32L47xxx/48xxx bootloader is activated by applying pattern7 (described in [Table 2: Bootloader activation patterns](#)). The following table shows the hardware resources used by this bootloader.

Table 120. STM32L47xxx/48xxx configuration in system memory boot mode

Bootloader	Feature/Peripheral	State	Comment
Common to all bootloaders	RCC	HSI enabled	The HSI is used at startup as clock source for system clock configured to 72 MHz and for USART and I2C bootloader operation.
		HSE enabled	The HSE is used only when the USB interface is selected and the LSE is not present. The HSE must have one of the following values [24,20,18,16,12,8,6,4] MHz. System is clocked at 72 MHz if USB is used or 60 MHz if CAN is used.
		LSE enabled	The LSE is used to trim the MSI which is configured to 48 MHz as USB clock source. The LSE must be equal to 32,768 KHz. If the LSE is not detected, the HSE will be used instead if USB is connected.
		MSI enabled	The MSI is configured to 48 MHz and will be used as USB clock source. The MSI is used only if LSE is detected, otherwise, HSE will be used if USB is connected.
		CSS	The Clock Security System (CSS) interrupt is enabled when LSE or HSE is enabled. Any failure (or removal) of the external clock generates system reset.
	RAM	-	13 Kbyte starting from address 0x20000000 are used by the bootloader firmware
	System memory	-	28 Kbyte starting from address 0x1FFF0000, contain the bootloader firmware
	IWDG	-	The independent watchdog (IWDG) prescaler is configured to its maximum value. It is periodically refreshed to prevent watchdog reset (in case the hardware IWDG option was previously enabled by the user).
	Power	-	The DFU can't be used to communicate with bootloader if the voltage scaling range 2 is selected. Bootloader firmware doesn't configure voltage scaling range value in PWR_CR1 register.
USART1 bootloader	USART1	Enabled	Once initialized the USART1 configuration is: 8-bits, even parity and 1 Stop bit
	USART1_RX pin	Input	PA10 pin: USART2 in reception mode
	USART1_TX pin	Output	PA9 pin: USART2 in transmission mode

Table 120. STM32L47xxx/48xxx configuration in system memory boot mode (continued)

Bootloader	Feature/Peripheral	State	Comment
USART2 bootloader	USART2	Enabled	Once initialized the USART2 configuration is: 8-bits, even parity and 1 Stop bit
	USART2_RX pin	Input	PA3 pin: USART2 in reception mode
	USART2_TX pin	Output	PA2 pin: USART2 in transmission mode
USART3 bootloader	USART3	Enabled	Once initialized the USART3 configuration is: 8-bits, even parity and 1 Stop bit
	USART3_RX pin	Input	PC11 pin: USART3 in reception mode
	USART3_TX pin	Output	PC10 pin: USART3 in transmission mode
USARTx bootloaders	SysTick timer	Enabled	Used to automatically detect the serial baud rate from the host for USARTx bootloaders.
I2C1 bootloader	I2C1	Enabled	The I2C1 configuration is: I2C speed: up to 400 KHz, 7-bit address, slave mode, analog filter ON. Slave 7-bit address: 0b1000011x (where x = 0 for write and x = 1 for read)
	I2C1_SCL pin	Input/Output	PB6 pin: clock line is used in open-drain mode.
	I2C1_SDA pin	Input/Output	PB7 pin: data line is used in open-drain mode.
I2C2 bootloader	I2C2	Enabled	The I2C2 configuration is: I2C speed: up to 400 KHz, 7-bit address, slave mode, analog filter ON. Slave 7-bit address: 0b1000011x (where x = 0 for write and x = 1 for read)
	I2C2_SCL pin	Input/Output	PB10 pin: clock line is used in open-drain mode.
	I2C2_SDA pin	Input/Output	PB11 pin: data line is used in open-drain mode.
I2C3 bootloader	I2C3	Enabled	The I2C3 configuration is: I2C speed: up to 400 KHz, 7-bit address, slave mode, analog filter ON. Slave 7-bit address: 0b1000011x (where x = 0 for write and x = 1 for read)
	I2C3_SCL pin	Input/Output	PC0 pin: clock line is used in open-drain mode.
	I2C3_SDA pin	Input/Output	PC1 pin: data line is used in open-drain mode.
SPI1 bootloader	SPI1	Enabled	The SPI1 configuration is: Slave mode, Full Duplex, 8-bit MSB, Speed up to 8 MHz, Polarity: CPOL Low, CPHA Low, NSS hardware.
	SPI1_MOSI pin	Input	PA7 pin: Slave data Input line, used in push-pull pull-down mode
	SPI1_MISO pin	Output	PA6 pin: Slave data output line, used in push-pull pull-down mode
	SPI1_SCK pin	Input	PA5 pin: Slave clock line, used in push-pull pull-down mode
	SPI1_NSS pin	Input	PA4 pin: slave chip select pin used in push-pull pull-down mode.

Table 120. STM32L47xxx/48xxx configuration in system memory boot mode (continued)

Bootloader	Feature/Peripheral	State	Comment
SPI2 bootloader	SPI2	Enabled	The SPI2 configuration is: Slave mode, Full Duplex, 8-bit MSB, Speed up to 8 MHz, Polarity: CPOL Low, CPHA Low, NSS hardware
	SPI2_MOSI pin	Input	PB15 pin: Slave data Input line, used in push-pull pull-down mode
	SPI2_MISO pin	Output	PB14 pin: Slave data output line, used in push-pull pull-down mode
	SPI2_SCK pin	Input	PB13 pin: Slave clock line, used in push-pull pull-down mode
	SPI2_NSS pin	Input	PB12 pin: slave chip select pin used in push-pull pull-down mode.
CAN1 bootloader	CAN1	Enabled	Once initialized the CAN1 configuration is: Baudrate 125 kbps, 11-bit identifier.
	CAN1_RX pin	Input	PB8 pin: CAN1 in reception mode
	CAN1_TX pin	Output	PB9 pin: CAN1 in transmission mode
DFU bootloader	USB	Enabled	USB FS configured in forced device mode. USB FS interrupt vector is enabled and used for USB DFU communications. Note: VDDUSB IO must be connected to 3.3V for USB to be operational.
	USB_DM pin	Input/Output	PA11 pin: USB FS DM line
	USB_DP pin		PA12 pin: USB FS DP line. No external Pull-up resistor is required.

In case, the HSE is present, the system clock and USB clock will be configured respectively to 72 MHz and 48 MHz with PLL (clocked by HSE) as a clock source.

56.2.2 Bootloader selection

The [Figure 75](#) and [Figure 76](#) show the bootloader selection mechanism.

Figure 75. Dual Bank Boot Implementation for STM32L47xxx/48xxx bootloader V9.x

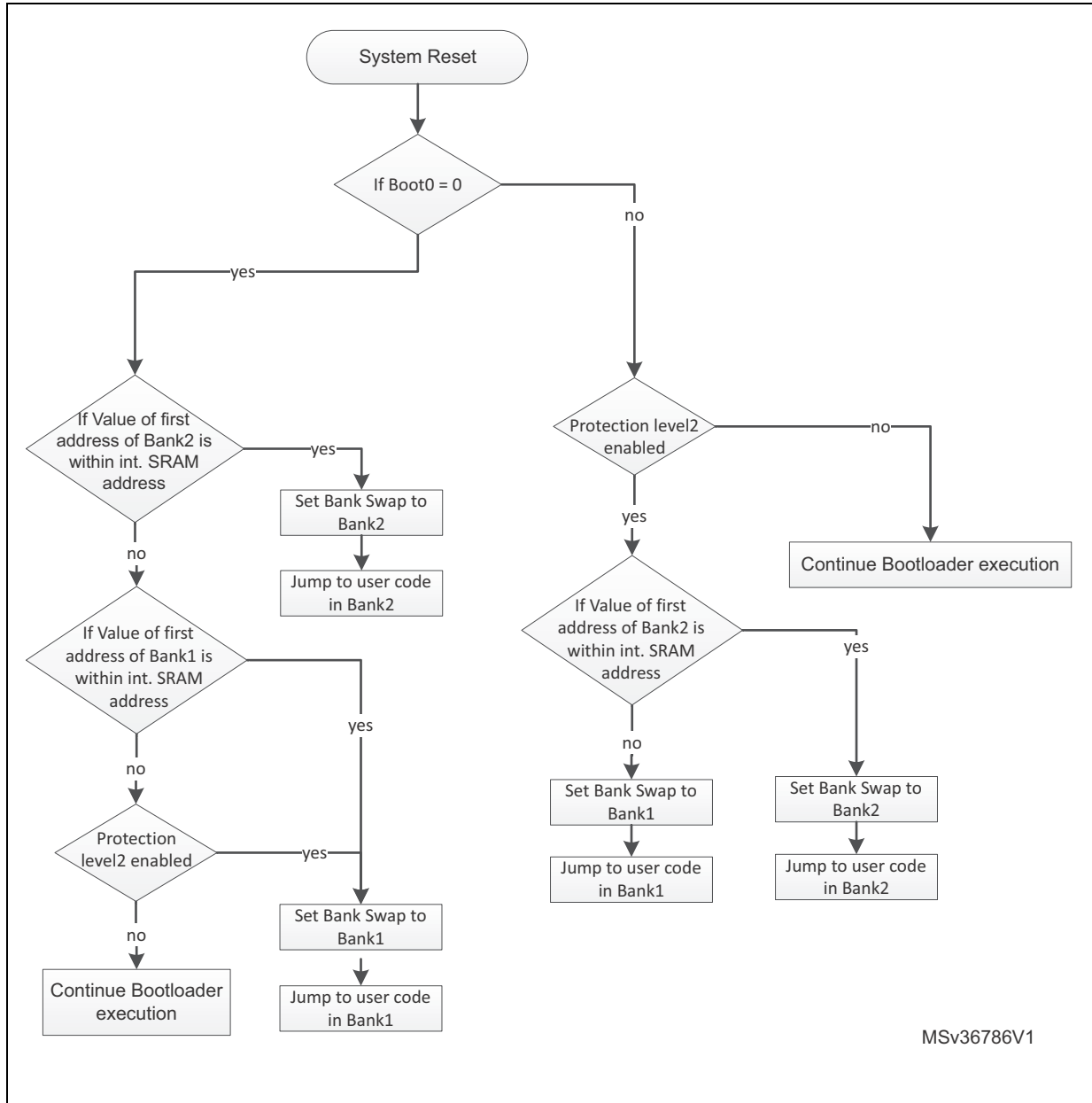
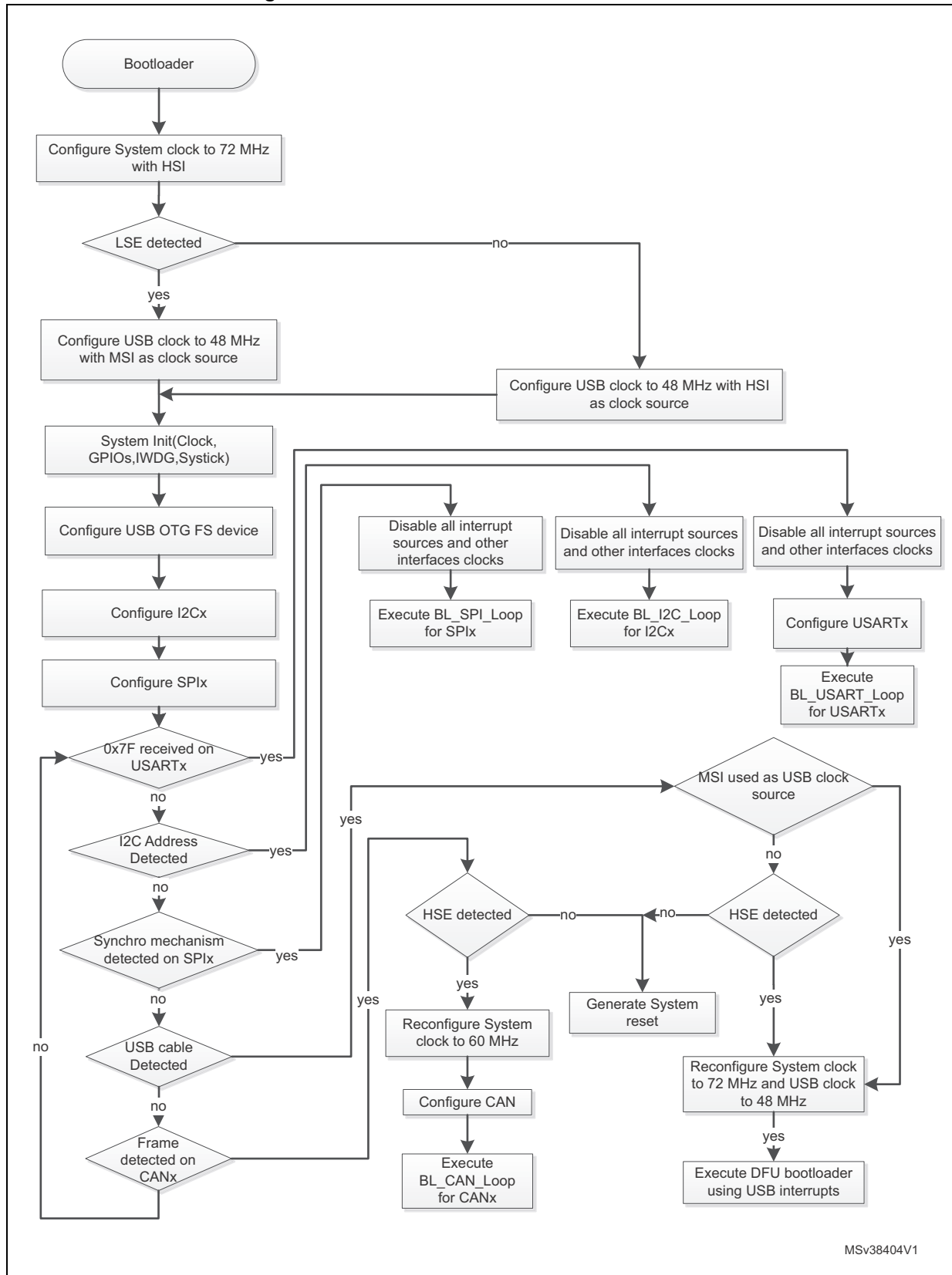

Figure 76.Bootloader V9.x selection for STM32L47xxx/48xxx



MSv38404V1

56.2.3 Bootloader version

The following table lists the STM32L47xxx/48xxx devices bootloader V9.x versions:

Table 121. STM32L47xxx/48xxx bootloader V9.x versions

Bootloader version number	Description	Known limitations
V9.0	Initial bootloader version	For memory write operations using DFU interface: If the buffer size is larger than 256 bytes and not multiple of 8 bytes, the write memory operation result is corrupted. Workaround: if the file size is larger than 256 bytes, add byte padding to align it on 8-bytes multiple size. Write in SRAM is corrupted
V9.1	Deprecated version (not used)	None
V9.2	Fix write in SRAM issue	<ul style="list-style-type: none"> – For memory write operations using DFU interface: If the buffer size is larger than 256 bytes and not multiple of 8 bytes, the write memory operation result is corrupted. Workaround: if the file size is larger than 256 bytes, add byte padding to align it on 8-bytes multiple size. – PcROP option bytes cannot be written as Bootloader uses Byte access while PcROP must be accessed using Half-Word access. Workaround: load a code snippet in SRAM using Bootloader interface then jump to it, and that code would write PcROP value.

57 STM32L496xx/4A6xx devices bootloader

57.1 Bootloader configuration

The STM32L496xx/4A6xx bootloader is activated by applying pattern6 (described in [Table 2: Bootloader activation patterns](#)). The [Table 122](#) shows the hardware resources used by this bootloader.

Table 122. STM32L496xx/4A6xx configuration in system memory boot mode

Bootloader	Feature/Peripheral	State	Comment
Common to all bootloaders	RCC	HSI enabled	The HSI is used at startup as clock source for system clock configured to 72 MHz and for USART, I2C and SPI bootloader operation.
		-	The clock recovery system (CRS) is enabled for the DFU bootloader to allow USB to be clocked by HSI 48 MHz.
		HSE enabled	The HSE is used only when the CAN interface is selected . The HSE must have one of the following value [24,20,18,16,12,9,8,6,4] MHz.
		-	The Clock Security System (CSS) interrupt is enabled when HSE is enabled. Any failure (or removal) of the external clock generates system reset
	RAM	-	12 Kbyte starting from address 0x20000000 are used by the bootloader firmware
	System memory	-	28 Kbyte starting from address 0x1FFF0000, contain the bootloader firmware
	IWDG	-	The independent watchdog (IWDG) prescaler is configured to its maximum value. It is periodically refreshed to prevent watchdog reset (in case the hardware IWDG option was previously enabled by the user).
Power	-	The DFU can't be used to communicate with bootloader if the voltage scaling range 2 is selected. Bootloader firmware doesn't configure voltage scaling range value in PWR_CR1 register.	
USART1 bootloader	USART1	Enabled	Once initialized the USART1 configuration is: 8-bits, even parity and 1 Stop bit
	USART1_RX pin	Input	PA10 pin: USART1 in reception mode
	USART1_TX pin	Output	PA9 pin: USART1 in transmission mode

Table 122. STM32L496xx/4A6xx configuration in system memory boot mode (continued)

Bootloader	Feature/Peripheral	State	Comment
USART2 bootloader	USART2	Enabled	Once initialized the USART2 configuration is: 8-bits, even parity and 1 Stop bit
	USART2_RX pin	Input	PA3 pin: USART2 in reception mode
	USART2_TX pin	Output	PA2 pin: USART2 in transmission mode
USART3 bootloader	USART3	Enabled	Once initialized the USART3 configuration is: 8-bits, even parity and 1 Stop bit
	USART3_RX pin	Input	PC11 pin: USART3 in reception mode
	USART3_TX pin	Output	PC10 pin: USART3 in transmission mode
USARTx bootloaders	SysTick timer	Enabled	Used to automatically detect the serial baud rate from the host for USARTx bootloaders.
I2C1 bootloader	I2C1	Enabled	The I2C1 configuration is: I2C speed: up to 1 MHz, 7-bit address, slave mode, analog filter ON. Slave 7-bit address: 0b1001100x (where x = 0 for write and x = 1 for read)
	I2C1_SCL pin	Input/Output	PB6 pin: clock line is used in open-drain mode.
	I2C1_SDA pin	Input/Output	PB7 pin: data line is used in open-drain mode.
I2C2 bootloader	I2C2	Enabled	The I2C2 configuration is: I2C speed: up to 1 MHz, 7-bit address, slave mode, analog filter ON. Slave 7-bit address: 0b1001100x (where x = 0 for write and x = 1 for read)
	I2C2_SCL pin	Input/Output	PB10 pin: clock line is used in open-drain mode.
	I2C2_SDA pin	Input/Output	PB11 pin: data line is used in open-drain mode.
I2C3 bootloader	I2C3	Enabled	The I2C3 configuration is: I2C speed: up to 1 MHz, 7-bit address, slave mode, analog filter ON. Slave 7-bit address: 0b1001100x (where x = 0 for write and x = 1 for read)
	I2C3_SCL pin	Input/Output	PC0 pin: clock line is used in open-drain mode.
	I2C3_SDA pin	Input/Output	PC1 pin: data line is used in open-drain mode.

Table 122. STM32L496xx/4A6xx configuration in system memory boot mode (continued)

Bootloader	Feature/Peripheral	State	Comment
SPI1 bootloader	SPI1	Enabled	The SPI1 configuration is: – Slave mode – Full Duplex – 8-bit MSB – Speed up to 8 MHz – Polarity: CPOL Low, CPHA Low, NSS hardware.
	SPI1_MOSI pin	Input	PA7 pin: Slave data Input line, used in push-pull pull-down mode
	SPI1_MISO pin	Output	PA6 pin: Slave data output line, used in push-pull pull-down mode
	SPI1_SCK pin	Input	PA5 pin: Slave clock line, used in push-pull pull-down mode
	SPI1_NSS pin	Input	PA4 pin: slave chip select pin used in push-pull pull-down mode. Note: This IO can be tied to Gnd if the SPI Master does not use it.
SPI2 bootloader	SPI2	Enabled	The SPI2 configuration is: – Slave mode – Full Duplex – 8-bit MSB – Speed up to 8 MHz – Polarity: CPOL Low, CPHA Low, NSS hardware.
	SPI2_MOSI pin	Input	PB15 pin: Slave data Input line, used in push-pull pull-down mode
	SPI2_MISO pin	Output	PB14 pin: Slave data output line, used in push-pull pull-down mode
	SPI2_SCK pin	Input	PB13 pin: Slave clock line, used in push-pull pull-down mode
	SPI2_NSS pin	Input	PB12 pin: slave chip select pin used in push-pull pull-down mode. Note: This IO can be tied to GND if the SPI Master does not use it.
CAN1 bootloader	CAN1	Enabled	Once initialized the CAN1 configuration is: Baudrate 125 kbps, 11 -bit identifier.
	CAN1_RX pin	Input	PB8 pin: CAN1 in reception mode
	CAN1_TX pin	Output	PB9 pin: CAN1 in transmission mode
	TIM16	Enabled	This timer is used to determine the value of the HSE. Once the HSE frequency is determined, the system clock is configured to 60 MHz using PLL and HSE.

Table 122. STM32L496xx/4A6xx configuration in system memory boot mode (continued)

Bootloader	Feature/Peripheral	State	Comment
DFU bootloader	USB	Enabled	USB OTG FS configured in forced device mode. USB OTG FS interrupt vector is enabled and used for USB DFU communications. Note: VDDUSB IO must be connected to 3.3V for USB to be operational.
	USB_DM pin	Input/Output	PA11: USB DM line.
	USB_DP pin		PA12: USB DP line No external Pull-up resistor is required

57.2 Bootloader selection

The [Figure 77](#) shows the bootloader selection mechanism.

Figure 77.Bootloader V9.x selection for STM32L496xx/4A6xx

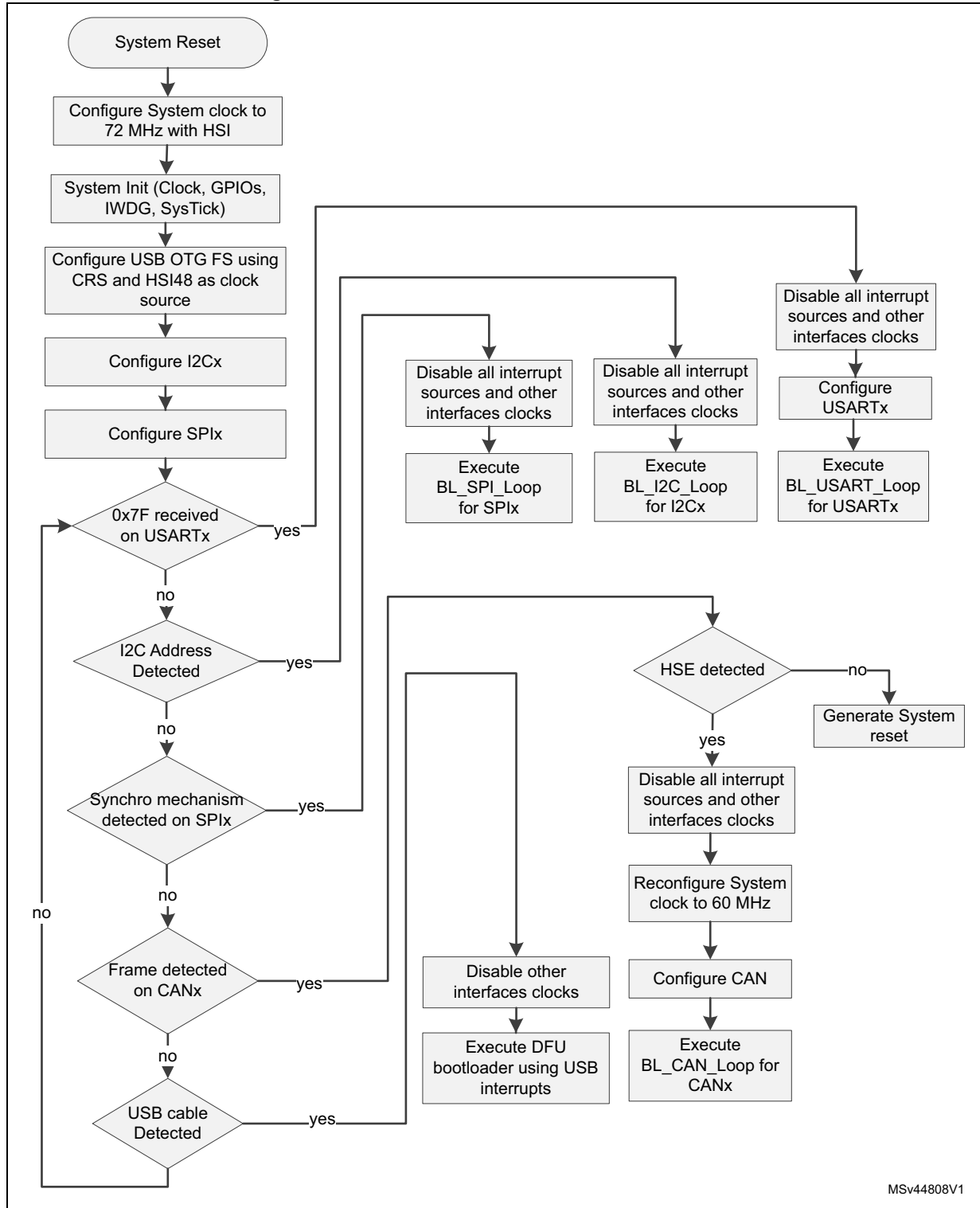

57.3 Bootloader version

The [Table 123](#) lists the STM32L496xx/4A6xx devices bootloader versions.

Table 123. STM32L496xx/4A6xx bootloader version

Bootloader version number	Description	Known limitations
V9.3	Initial bootloader version	<ul style="list-style-type: none"> – The Bank Erase command is aborted by the bootloader device, and the NACK (0x1F) is sent to the host. Workaround: Perform Bank erase operation through page erase using the Erase command (0x44). – SPI write operation fail <p>Limitation:</p> <ul style="list-style-type: none"> a. During Bootloader SPI write Flash memory operation, some random 64-bits (2 double-words) may be left blank at 0xFF. <p>Root cause:</p> <ul style="list-style-type: none"> a. Bootloader uses 64-bits cast write operation which is interrupted by SPI DMA and it leads to double access on same Flash memory address and the 64-bits are not written <p>Workarounds:</p> <ul style="list-style-type: none"> a. WA1: add a delay between sending write command and its ACK request. Its duration should be the duration of the 256-Bytes Flash memory write time. b. WA2: read back after write and in case of error start write again. c. WA3: Patch in RAM to write in Flash memory that implements write memory without 64-bits cast. <p>WA1 and WA3 are more efficient than WA2 in terms of total programming time</p> <p>How critical is the limitation:</p> <ul style="list-style-type: none"> a. The limitation leads to a modification in customer SPI host software by adding 3-4 ms delay to each write operation. b. The delay is not waste because it's anyway the Flash memory write period of time that host has to wait anyway (so instead of waiting by sending ACK requests, host will wait by delay). c. Limitation has been seen only on SPI and cannot impact USART/I2C/CAN. <ul style="list-style-type: none"> – PcROP option bytes cannot be written as Bootloader uses Byte access while PcROP must be accessed using Half-Word access. <p>Workaround: load a code snippet in SRAM using Bootloader interface then jump to it, and that code would write PcROP value.</p>

58 STM32L4Rxxx/4Sxxx devices bootloader

58.1 Bootloader configuration

The STM32L4Rxx/4Sxx bootloader is activated by applying pattern6 (described in [Table 2: Bootloader activation patterns](#)). The [Table 124](#) shows the hardware resources used by this bootloader.

Table 124. STM32L4Rxxx/4Sxxx configuration in system memory boot mode

Bootloader	Feature/Peripheral	State	Comment
Common to all bootloaders	RCC	HSI enabled	The HSI is used at startup as clock source for system clock configured to 60 MHz and for USART, I2C, SPI and USB bootloader operation.
		-	The clock recovery system (CRS) is enabled for the DFU bootloader to allow USB to be clocked by HSI 48 MHz.
		HSE enabled	The HSE is used only when the CAN interface is selected . The HSE must have one of the following value [24,20,18,16,12,9,8,6,4] MHz.
		-	The Clock Security System (CSS) interrupt is enabled when HSE is enabled. Any failure (or removal) of the external clock generates system reset
	RAM	-	12 Kbytes starting from address 0x20000000 are used by the bootloader firmware
	System memory	-	28672 bytes starting from address 0x1FFF0000, contain the bootloader firmware
	IWDG	-	The independent watchdog (IWDG) prescaler is configured to its maximum value. It is periodically refreshed to prevent watchdog reset (in case the hardware IWDG option was previously enabled by the user).
	Power	-	The DFU can't be used to communicate with bootloader if the voltage scaling range 2 is selected. Bootloader firmware doesn't configure voltage scaling range value in PWR_CR1 register.

Table 124. STM32L4Rxxx/4Sxxx configuration in system memory boot mode (continued)

Bootloader	Feature/Peripheral	State	Comment
USART1 bootloader	USART1	Enabled	Once initialized the USART1 configuration is: 8-bits, even parity and 1 Stop bit
	USART1_RX pin	Input	PA10 pin: USART1 in reception mode
	USART1_TX pin	Output	PA9 pin: USART1 in transmission mode
USART2 bootloader	USART2	Enabled	Once initialized the USART2 configuration is: 8-bits, even parity and 1 Stop bit
	USART2_RX pin	Input	PA3 pin: USART2 in reception mode
	USART2_TX pin	Output	PA2 pin: USART2 in transmission mode
USART3 bootloader	USART3	Enabled	Once initialized the USART3 configuration is: 8-bits, even parity and 1 Stop bit
	USART3_RX pin	Input	PC11 pin: USART3 in reception mode
	USART3_TX pin	Output	PC10 pin: USART3 in transmission mode
USARTx bootloaders	SysTick timer	Enabled	Used to automatically detect the serial baud rate from the host for USARTx bootloaders.
I2C1 bootloader	I2C1	Enabled	The I2C1 configuration is: I2C speed: up to 1 MHz, 7-bit address, slave mode, analog filter ON. Slave 7-bit address: 0b1010000x (where x = 0 for write and x = 1 for read)
	I2C1_SCL pin	Input/Output	PB6 pin: clock line is used in open-drain mode.
	I2C1_SDA pin	Input/Output	PB7 pin: data line is used in open-drain mode.
I2C2 bootloader	I2C2	Enabled	The I2C2 configuration is: I2C speed: up to 1 MHz, 7-bit address, slave mode, analog filter ON. Slave 7-bit address: 0b1010000x (where x = 0 for write and x = 1 for read)
	I2C2_SCL pin	Input/Output	PB10 pin: clock line is used in open-drain mode.
	I2C2_SDA pin	Input/Output	PB11 pin: data line is used in open-drain mode.

Table 124. STM32L4Rxxx/4Sxxx configuration in system memory boot mode (continued)

Bootloader	Feature/Peripheral	State	Comment
I2C3 bootloader	I2C3	Enabled	The I2C3 configuration is: I2C speed: up to 1 MHz, 7-bit address, slave mode, analog filter ON. Slave 7-bit address: 0b1010000x (where x = 0 for write and x = 1 for read)
	I2C3_SCL pin	Input/Output	PC0 pin: clock line is used in open-drain mode.
	I2C3_SDA pin	Input/Output	PC1 pin: data line is used in open-drain mode.
SPI1 bootloader	SPI1	Enabled	The SPI1 configuration is: – Slave mode – Full Duplex – 8-bit MSB – Speed up to 8 MHz – Polarity: CPOL Low, CPHA Low, NSS hardware.
	SPI1_MOSI pin	Input	PA7 pin: Slave data Input line, used in push-pull pull-down mode
	SPI1_MISO pin	Output	PA6 pin: Slave data output line, used in push-pull pull-down mode
	SPI1_SCK pin	Input	PA5 pin: Slave clock line, used in push-pull pull-down mode
	SPI1_NSS pin	Input	PA4 pin: slave chip select pin used in push-pull pull-up mode. Note: This IO can be tied to Gnd if the SPI Master does not use it.
SPI2 bootloader	SPI2	Enabled	The SPI2 configuration is: – Slave mode – Full Duplex – 8-bit MSB – Speed up to 8 MHz – Polarity: CPOL Low, CPHA Low, NSS hardware.
	SPI2_MOSI pin	Input	PB15 pin: Slave data Input line, used in push-pull pull-down mode
	SPI2_MISO pin	Output	PB14 pin: Slave data output line, used in push-pull pull-down mode
	SPI2_SCK pin	Input	PB13 pin: Slave clock line, used in push-pull pull-down mode
	SPI2_NSS pin	Input	PB12 pin: slave chip select pin used in push-pull pull-up mode. Note: This IO can be tied to Gnd if the SPI Master does not use it.

Table 124. STM32L4Rxxx/4Sxxx configuration in system memory boot mode (continued)

Bootloader	Feature/Peripheral	State	Comment
CAN1 bootloader	CAN1	Enabled	Once initialized the CAN1 configuration is: Baudrate 125 kbps, 11 -bit identifier.
	CAN1_RX pin	Input	PB8 pin: CAN1 in reception mode
	CAN1_TX pin	Output	PB9 pin: CAN1 in transmission mode
	TIM16	Enabled	This timer is used to determine the value of the HSE. Once the HSE frequency is determined, the system clock is configured to 60 MHz using PLL and HSE.
DFU bootloader	USB	Enabled	USB FS configured in forced device mode. USB FS interrupt vector is enabled and used for USB DFU communications. Note: VDDUSB IO must be connected to 3.3V for USB to be operational.
	USB_DM pin	Input/Output	PA11: USB DM line.
	USB_DP pin		PA12: USB DP line No external Pull-up resistor is required

58.2 Bootloader selection

The [Figure 78](#) and [Figure 79](#) show the bootloader selection mechanisms.

Figure 78. Dual bank boot implementation for STM32L4Rxxx/STM32L4Sxxx bootloader V9.x

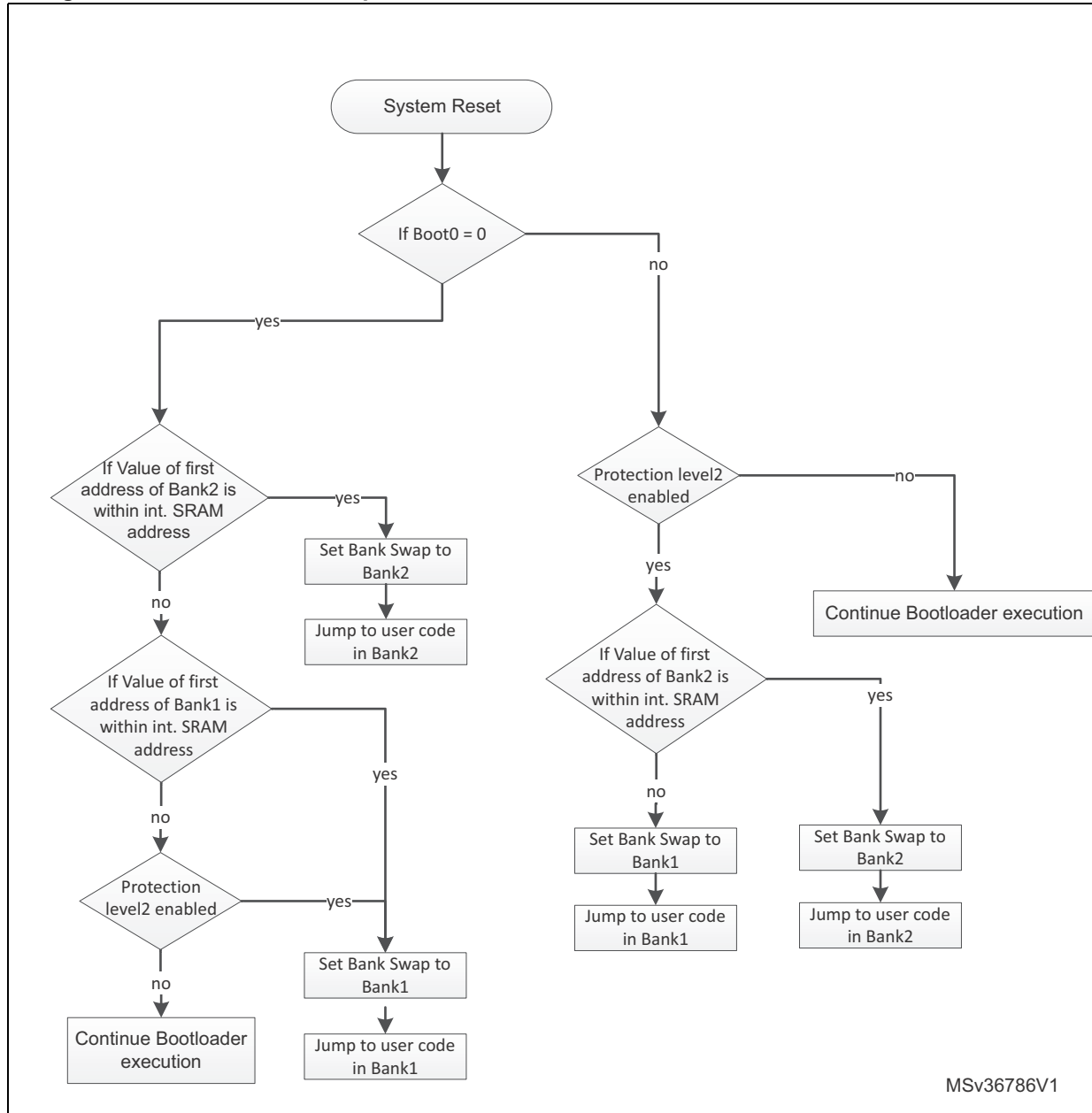
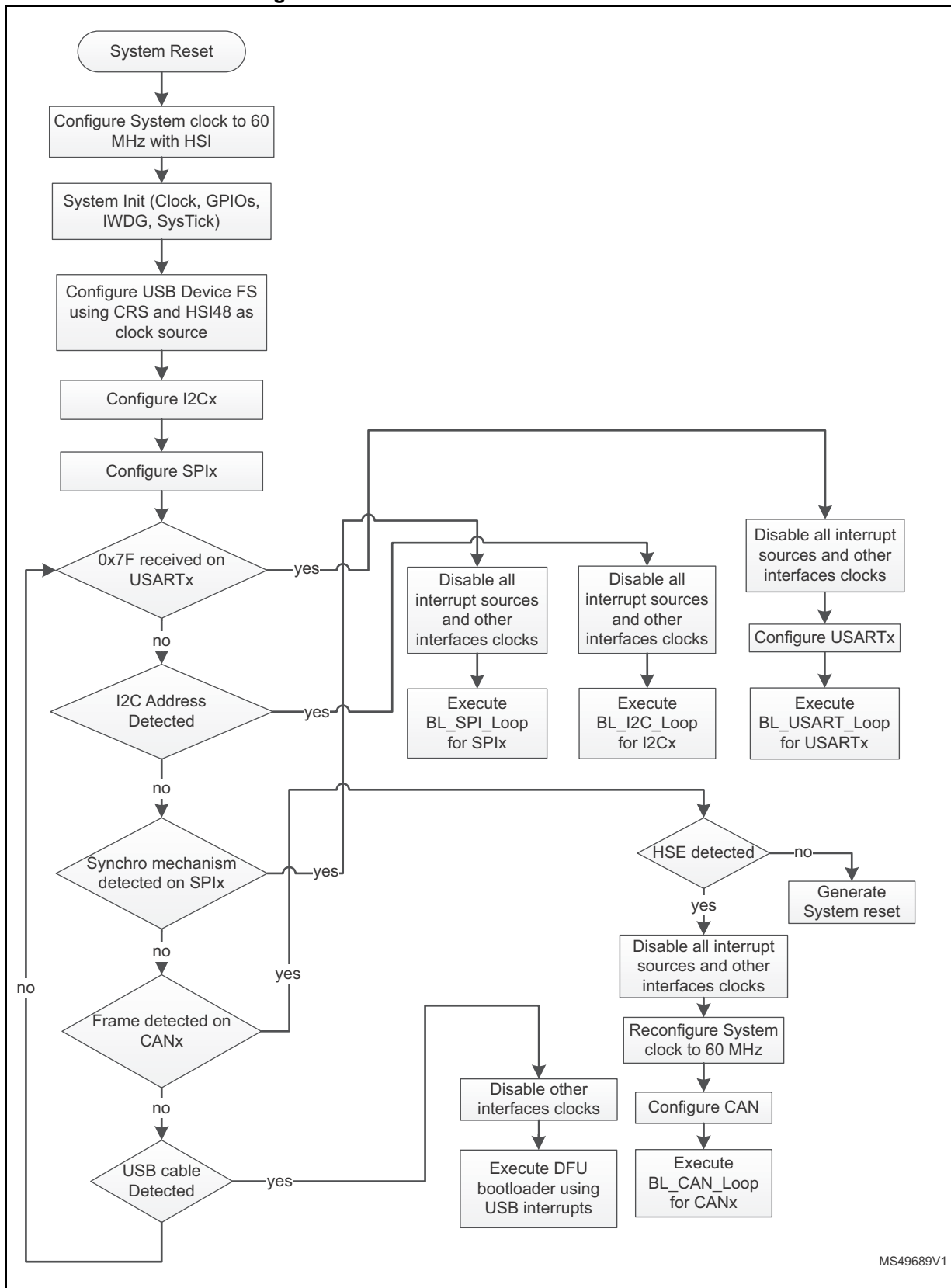

Figure 79.Bootloader V9.x selection for STM32L4Rxx/4Sxx



MS49689V1

58.3 Bootloader version

The [Table 125](#) lists the STM32L4Rxx/4Sxx devices bootloader versions.

Table 125. STM32L4Rxx/4Sxx bootloader versions

Bootloader version number	Description	Known limitations
V9.0	Initial bootloader version	– USB sometimes not detected
V9.1	<ul style="list-style-type: none"> – Fix of previous release issues – Manage dual bank boot mechanism and sizes with different sales types 	– Random issue on the SPI write memory due to 64 bits write function
V9.2	<ul style="list-style-type: none"> – Fix of previous release issues – Add Bank erase feature – Support for Get Checksum Command for I2C and SPI 	<ul style="list-style-type: none"> – Sales type 1 M detected as 512 KB samples and 512 KB samples and 512 KB samples detected as 1 MB – Crash seen on the BL when using 1 MB sales type (BL not usable as entering in loop crash and system reset)
V9.3	Not public	NA
V9.4	Fix of previous release issues. Fix CAN instability issue	None

59 STM32L552xx/STM32L562xx devices bootloader

59.1 Bootloader configuration

The STM32L552xx/562xx bootloader is activated by applying pattern12 (described in [Table 2: Bootloader activation patterns](#)). The following table shows the hardware resources used by this bootloader.

Table 126. STM32L552xx/562xx configuration in system memory boot mode

Bootloader	Feature/Peripheral	State	Comment
Common to all bootloaders	RCC	HSI enabled	The system clock frequency is 60 MHz (using PLL clocked by HSI).
		-	The clock recovery system (CRS) is enabled for the DFU bootloader to allow USB to be clocked by HSI 48 MHz.
		-	20 MHz derived from the PLLQ is used for FDCAN
	RAM	-	16 Kbytes starting from address 0x20000000 are used by the bootloader firmware
	System memory	-	32 Kbytes starting from address 0x0BF90000.
USART1 bootloader	IWDG	-	The independent watchdog (IWDG) prescaler is configured to its maximum value. It is periodically refreshed to prevent watchdog reset (in case the hardware IWDG option was previously enabled by the user).
	USART1	Enabled	Once initialized the USART1 configuration is: 8-bits, even parity and 1 Stop bit
	USART1_RX pin	Input	PA10 pin: USART1 in reception mode
USART2 bootloader	USART1_TX pin	Output	PA9 pin: USART1 in transmission mode
	USART2	Enabled	Once initialized the USART2 configuration is: 8-bits, even parity and 1 Stop bit
	USART2_RX pin	Input	PA3 pin: USART2 in reception mode
USART3 bootloader	USART2_TX pin	Output	PA2 pin: USART2 in transmission mode
	USART3	Enabled	Once initialized the USART3 configuration is: 8-bits, even parity and 1 Stop bit
	USART3_RX pin	Input	PC11 pin: USART3 in reception mode
USART3 bootloader	USART3_TX pin	Output	PC10 pin: USART3 in transmission mode

Table 126. STM32L552xx/562xx configuration in system memory boot mode (continued)

Bootloader	Feature/Peripheral	State	Comment
I2C1 bootloader	I2C1	Enabled	The I2C1 configuration is: I2C speed: up to 1 MHz, 7-bit address, slave mode, analog filter ON. Slave 7-bit address: 0b1010000x (where x = 0 for write and x = 1 for read)
	I2C1_SCL pin	Input/Output	PB6 pin: clock line is used in open-drain mode.
	I2C1_SDA pin	Input/Output	PB7 pin: data line is used in open-drain mode.
I2C2 bootloader	I2C2	Enabled	The I2C2 configuration is: I2C speed: up to 1 MHz, 7-bit address, slave mode, analog filter ON. Slave 7-bit address: 0b1010000x (where x = 0 for write and x = 1 for read)
	I2C2_SCL pin	Input/Output	PB10 pin: clock line is used in open-drain mode.
	I2C2_SDA pin	Input/Output	PB11 pin: data line is used in open-drain mode.
I2C3 bootloader	I2C3	Enabled	The I2C3 configuration is: I2C speed: up to 1 MHz, 7-bit address, slave mode, analog filter ON. Slave 7-bit address: 0b1010000x (where x = 0 for write and x = 1 for read)
	I2C3_SCL pin	Input/Output	PC0 pin: clock line is used in open-drain mode.
	I2C3_SDA pin	Input/Output	PC1 pin: data line is used in open-drain mode.
SPI1 bootloader	SPI1	Enabled	The SPI1 configuration is: – Slave mode – Full Duplex – 8-bit MSB – Speed up to 8 MHz – Polarity: CPOL Low, CPHA Low, NSS hardware.
	SPI1_MOSI pin	Input	PA7 pin: Slave data Input line, used in push-pull pull-down mode
	SPI1_MISO pin	Output	PA6 pin: Slave data output line, used in push-pull pull-down mode
	SPI1_SCK pin	Input	PA5 pin: Slave clock line, used in push-pull pull-down mode
	SPI1_NSS pin	Input	PA4 pin: slave chip select pin used in push-pull pull-up mode. Note: This IO can be tied to Gnd if the SPI Master does not use it.

Table 126. STM32L552xx/562xx configuration in system memory boot mode (continued)

Bootloader	Feature/Peripheral	State	Comment
SPI2 bootloader	SPI2	Enabled	The SPI2 configuration is: <ul style="list-style-type: none"> – Slave mode – Full Duplex – 8-bit MSB – Speed up to 8 MHz – Polarity: CPOL Low, CPHA Low, NSS hardware.
	SPI2_MOSI pin	Input	PB15 pin: Slave data Input line, used in push-pull pull-down mode
	SPI2_MISO pin	Output	PB14 pin: Slave data output line, used in push-pull pull-down mode
	SPI2_SCK pin	Input	PB13 pin: Slave clock line, used in push-pull pull-down mode
	SPI2_NSS pin	Input	PB12 pin: slave chip select pin used in push-pull pull-up mode. Note: This IO can be tied to Gnd if the SPI Master does not use it.
SPI3 bootloader	SPI3	Enabled	The SPI configuration is: <ul style="list-style-type: none"> – Slave mode – Full Duplex – 8-bit MSB – Speed up to 8 MHz – Polarity: CPOL Low, CPHA Low, NSS hardware.
	SPI3_MOSI pin	Input	PB5 pin: Slave data Input line, used in push-pull pull-down mode
	SPI3_MISO pin	Output	PG10 pin: Slave data output line, used in push-pull pull-down mode
	SPI3_SCK pin	Input	PG9 pin: Slave clock line, used in push-pull pull-down mode
	SPI3_NSS pin	Input	PG12 pin: slave chip select pin used in push-pull pull-up mode. Note: This IO can be tied to Gnd if the SPI Master does not use it.
FDCAN bootloader	FDCAN1	Enabled	USB FS configured in forced device mode. USB FS interrupt vector is enabled and used for USB DFU communications. Note: VDDUSB IO must be connected to 3.3V for USB to be operational.
	FDCAN1_Rx pin	Input/	PB9 pin: FDCAN1 in reception mode
	FDCAN1_Tx pin	Output	PB8 pin: FDCAN1 in transmission mode

59.2 Bootloader selection

The figure below shows the bootloader selection mechanism.

Figure 80. Bootloader V9.x selection for STM32L552xx/562xx

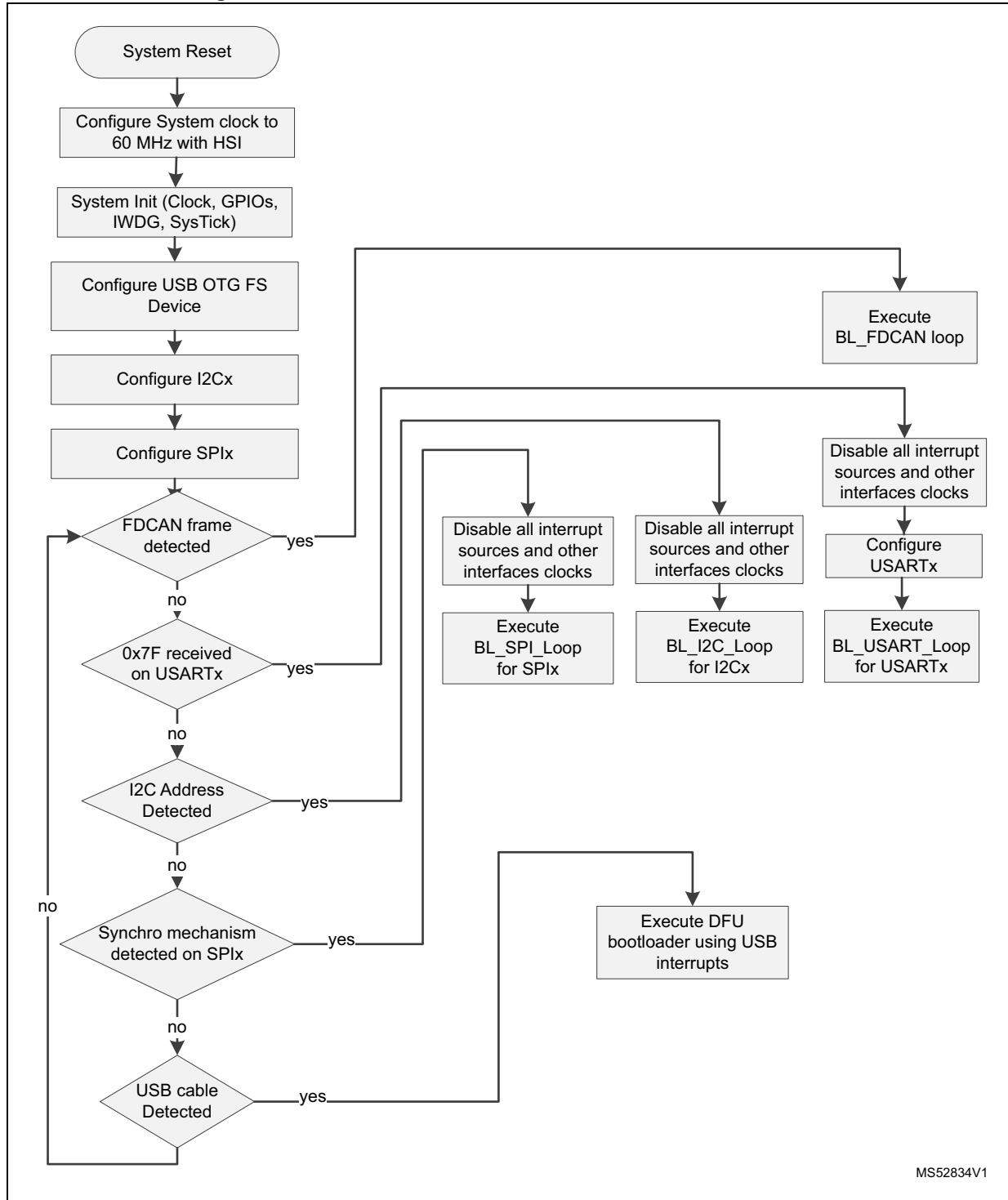

59.3 Bootloader version

The [Table 127](#) lists the STM32L552xx/562xx devices bootloader versions.

Table 127. STM32L552xx/562xx bootloader versions

Bootloader version number	Description	Known limitations
V13.0	Initial bootloader version on cut1.0 samples	<ul style="list-style-type: none"> – USART3 not working – SPI3 not working – OB launch not working on USB-DFU – No read/write SRAM2 in all protocols – Read Secure Option bytes only implemented on USART/I2C – Regression from TZen=1 to TZen=0 is done automatically on RDP regression
V9.0	Release supported only in cut2.0 <ul style="list-style-type: none"> – Fix all issues on previous release – Add FDCAN support – New command added for TZen disable – Support of sales type 256KB 	<ul style="list-style-type: none"> – Not able to set TZen to '1' option byte using all interfaces of the BL No WA available – Cannot set option byte using all interfaces of the BL when TZen is "1" and RDP level is 0.5 No WA available – Multiple reset seen when enabling HW IWDG option byte in TZen = '1' No WA available – Not able to set secure option bytes setting when TZen = '1' and RDP level is 0 No WA available – "Go" Command on USB is not working
V9.1	<ul style="list-style-type: none"> – Fix all known limitations of previous release – Add enable BOOT_LOCK BL command – Add support of RDP L1 to 0.5 regression 	None

60 STM32WB50xx/55xx devices bootloader

60.1 Bootloader configuration

The STM32WBxxx bootloader is activated by applying pattern6 (described in [Table 2: Bootloader activation patterns](#)). The following table shows the hardware resources used by this bootloader.

Table 128. STM32WB50xx/55xx configuration in system memory boot mode

Bootloader	Feature/Peripheral	State	Comment
Common to all bootloaders	RCC	MSI enabled	The system clock frequency is 64 MHz (using PLL clocked by MSI).
		-	The clock recovery system (CRS) is enabled for the DFU bootloader to allow USB to be clocked by HSI 48 MHz.
	RAM	-	20 Kbytes starting from address 0x20000000 are used by the bootloader firmware
	System memory	-	28 Kbytes starting from address 0x1FFF0000, contain the bootloader firmware
	IWDG	-	The independent watchdog (IWDG) prescaler is configured to its maximum value. It is periodically refreshed to prevent watchdog reset (in case the hardware IWDG option was previously enabled by the user).
USART1 bootloader	USART1	Enabled	Once initialized the USART1 configuration is: 8-bits, even parity and 1 Stop bit
	USART1_RX pin	Input	PA10 pin: USART1 in reception mode
	USART1_TX pin	Output	PA9 pin: USART1 in transmission mode
I2C1 bootloader	I2C1	Enabled	The I2C1 configuration is: I2C speed: up to 1 MHz, 7-bit address, slave mode, analog filter ON. Slave 7-bit address: 0b1010000x (where x = 0 for write and x = 1 for read)
	I2C1_SCL pin	Input/Output	PB6 pin: clock line is used in open-drain mode.
	I2C1_SDA pin	Input/Output	PB7 pin: data line is used in open-drain mode.

Table 128. STM32WB50xx/55xx configuration in system memory boot mode (continued)

Bootloader	Feature/Peripheral	State	Comment
I2C3 bootloader	I2C3	Enabled	The I2C3 configuration is: I2C speed: up to 1 MHz, 7-bit address, slave mode, analog filter ON. Slave 7-bit address: 0b1010000x (where x = 0 for write and x = 1 for read)
	I2C3_SCL pin	Input/Output	PC0 pin: clock line is used in open-drain mode.
	I2C3_SDA pin	Input/Output	PC1 pin: data line is used in open-drain mode.
SPI1 bootloader	SPI1	Enabled	The SPI1 configuration is: – Slave mode – Full Duplex – 8-bit MSB – Speed up to 8 MHz – Polarity: CPOL Low, CPHA Low, NSS hardware.
	SPI1_MOSI pin	Input	PA7 pin: Slave data Input line, used in push-pull pull-down mode
	SPI1_MISO pin	Output	PA6 pin: Slave data output line, used in push-pull pull-down mode
	SPI1_SCK pin	Input	PA5 pin: Slave clock line, used in push-pull pull-down mode
	SPI1_NSS pin	Input	PA4 pin: slave chip select pin used in push-pull pull-up mode. Note: This IO can be tied to Gnd if the SPI Master does not use it.
SPI2 bootloader	SPI2	Enabled	The SPI2 configuration is: – Slave mode – Full Duplex – 8-bit MSB – Speed up to 8 MHz – Polarity: CPOL Low, CPHA Low, NSS hardware.
	SPI2_MOSI pin	Input	PB15 pin: Slave data Input line, used in push-pull pull-down mode
	SPI2_MISO pin	Output	PB14 pin: Slave data output line, used in push-pull pull-down mode
	SPI2_SCK pin	Input	PB13 pin: Slave clock line, used in push-pull pull-down mode
	SPI2_NSS pin	Input	PB12 pin: slave chip select pin used in push-pull pull-up mode. Note: This IO can be tied to Gnd if the SPI Master does not use it.

Table 128. STM32WB50xx/55xx configuration in system memory boot mode (continued)

Bootloader	Feature/Peripheral	State	Comment
DFU bootloader	USB	Enabled	USB FS configured in forced device mode. USB FS interrupt vector is enabled and used for USB DFU communications. Note: VDDUSB IO must be connected to 3.3V for USB to be operational.
	USB_DM pin	Input/Output	PA11: USB DM line.
	USB_DP pin		PA12: USB DP line No external Pull-up resistor is required

60.2 Bootloader selection

The figure below shows the bootloader selection mechanism.

Figure 81. Bootloader V13.0 selection for STM32WB50xx/55xx

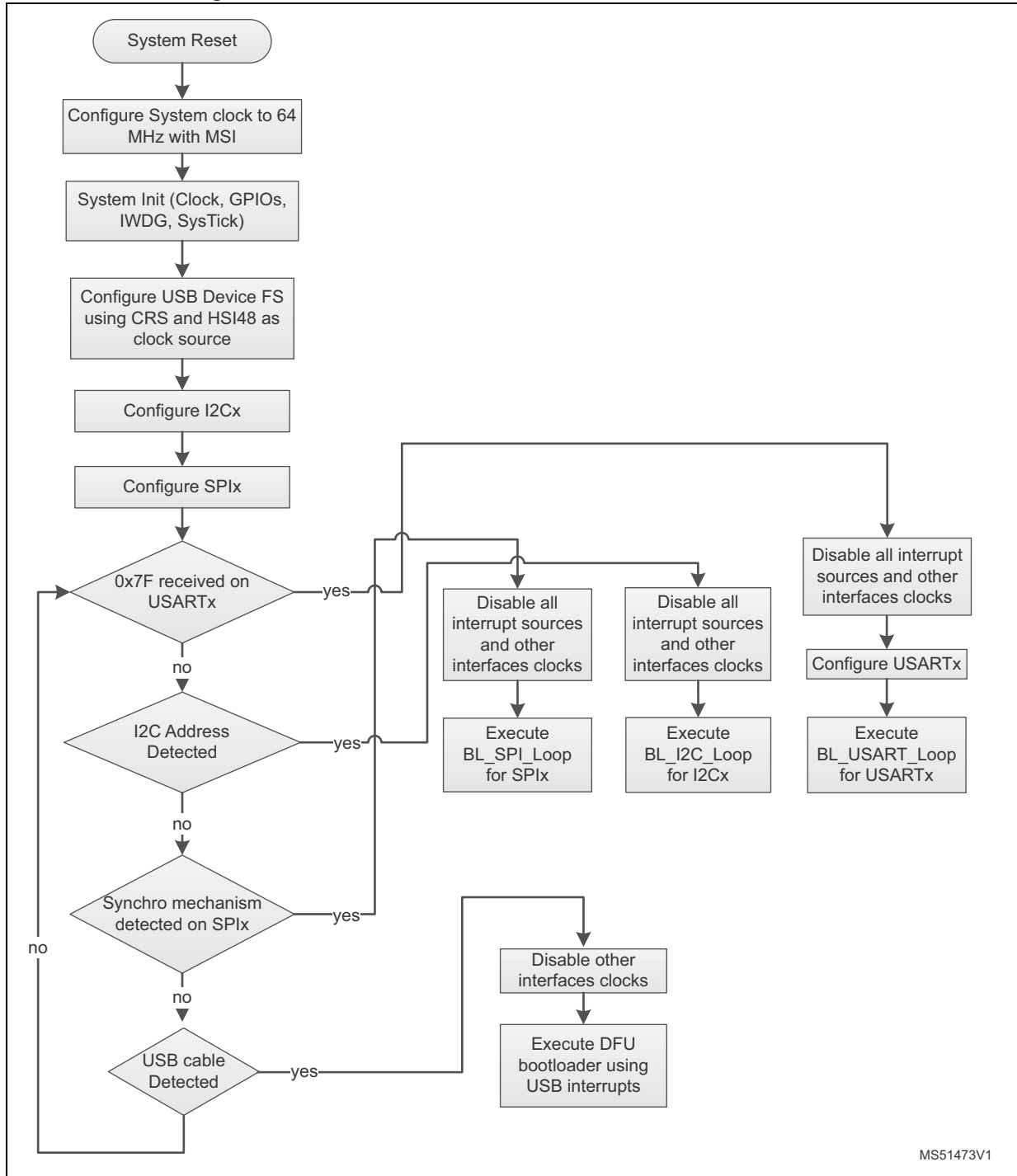

60.3 Bootloader version

Table 129. STM32WB50xx/55xx bootloader versions

Bootloader version number	Description	Known limitations
V13.5	Initial bootloader version	– Readout Unprotect Command is not working properly as at the end of the command an NVIC_SystemReset is done instead of a FLASH option bytes reload. This makes the change of the RDP level not effective until a power off power on.

Note: Instability when performing multiple resets during operations ongoing causing Overrun or FrameError errors on USART Bootloader and not recoverable unless Hardware Reset is performed. Fixed by workaround in FUS V1.0.1 and V1.0.2.

61 Device-dependent bootloader parameters

The bootloader protocol's command set and sequences for each serial peripheral are the same for all STM32 devices. However, some parameters depend on device and bootloader version:

- PID (Product ID)
- Valid RAM memory addresses (RAM area used during bootloader execution is not accessible) accepted by the bootloader when the Read Memory, Go and Write Memory commands are requested.
- System Memory area.

The table below shows the values of these parameters for each STM32 device bootloader in production.

Table 130. Bootloader device-dependent parameters

STM32 series	Device	PID	BL ID	RAM memory	System memory
F0	STM32F05xxx and STM32F030x8 devices	0x440	0x21	0x20000800 - 0x20001FFF	0x1FFFE000 - 0x1FFFF7FF
	STM32F03xx4/6	0x444	0x10	0x20000800 - 0x20000FFF	
	STM32F030xC	0x442	0x52	0x20001800 - 0x20007FFF	0x1FFFD800 - 0x1FFFF7FF
	STM32F04xxx	0x445	0xA1	NA	0x1FFFC400 - 0x1FFFF7FF
	STM32F070x6	0x445	0xA2	NA	0x1FFFC400 - 0x1FFFF7FF
	STM32F070xB	0x448	0xA2	NA	0x1FFFC800 - 0x1FFFF7FF
	STM32F071xx/072xx	0x448	0xA1	0x20001800 - 0x20003FFF	0x1FFFC800 - 0x1FFFF7FF
	STM32F09xxx	0x442	0x50	NA	0x1FFFD800 - 0x1FFFF7FF
F1	STM32F10xxx	Low-density	0x412	NA	0x1FFFF000 - 0x1FFFF7FF
		Medium-density	0x410	NA	
		High-density	0x414	NA	
		Medium-density value line	0x420	0x10	
		High-density value line	0x428	0x10	
	STM32F105xx/107xx	0x418	NA	0x20001000 - 0x2000FFFF	0x1FFFB000 - 0x1FFFF7FF
	STM32F10xxx XL-density	0x430	0x21	0x20000800 - 0x20017FFF	0x1FFFE000 - 0x1FFFF7FF
F2	STM32F2xxxx	0x411	0x20	0x20002000 - 0x2001FFFF	0x1FFF0000 - 0x1FFF77FF
	0x33				

Table 130. Bootloader device-dependent parameters (continued)

STM32 series	Device	PID	BL ID	RAM memory	System memory
F3	STM32F373xx	0x432	0x41	0x20001400 - 0x20007FFF	0x1FFFD800 - 0x1FFFF7FF
	STM32F378xx		0x50	0x20001000 - 0x20007FFF	
	STM32F302xB(C)/303xB(C)	0x422	0x41	0x20001400 - 0x20009FFF	
	STM32F358xx		0x50		
	STM32F301xx/302x4(6/8)	0x439	0x40	0x20001800 - 0x20003FFF	
	STM32F318xx		0x50		
	STM32F303x4(6/8)/334xx/328xx	0x438	0x50	0x20001800 - 0x20002FFF	
	STM32F302xD(E)/303xD(E)	0x446	0x40	0x20001800 - 0x2000FFFF	
STM32F398xx	0x446	0x50	0x20001800 - 0x2000FFFF		
F4	STM32F40xxx/41xxx	0x413	0x31	0x20002000 - 0x2001FFFF	0x1FFF0000 - 0x1FFF77FF
			0x90	0x20003000 - 0x2001FFFF	
	STM32F42xxx/43xxx	0x419	0x70	0x20003000 - 0x2002FFFF	
			0x91		
	STM32F401xB(C)	0x423	0xD1	0x20003000 - 0x2000FFFF	
	STM32F401xD(E)	0x433	0xD1	0x20003000 - 0x20017FFF	
	STM32F410xx	0x458	0xB1	0x20003000 - 0x20007FFF	
	STM32F411xx	0x431	0xD0	0x20003000 - 0x2001FFFF	
	STM32F412xx	0x441	0x90	0x20003000 - 0x2003FFFF	
	STM32F446xx	0x421	0x90	0x20003000 - 0x2001FFFF	
STM32F469xx/479xx	0x434	0x90	0x20003000 - 0x2005FFFF		
STM32F413xx/423xx	0x463	0x90	0x20003000 - 0x2004FFFF		
F7	STM32F72xxx/73xxx	0x452	0x90	0x20004000 - 0x2003FFFF	0x1FF00000 - 0x1FF0EDBF
	STM32F74xxx/75xxx	0x449	0x70	0x20004000 - 0x2004FFFF	0x1FF00000 - 0x1FF0EDBF
			0x90	0x20004000 - 0x2004FFFF	0x1FF00000 - 0x1FF0EDBF
STM32F76xxx/77xxx	0x451	0x93	0x20004000 - 0x2007FFFF	0x1FF00000 - 0x1FF0EDBF	
G0	STM32G03xxx/04xxx	0x466	0x52	0x20000000 - 0x20000FFF	0x1FFF0000 - 0x1FFF1FFF
	STM32G07xxx/08xxx	0x460	0xB2	0x20000000 - 0x200026FF	0x1FFF0000 - 0x1FFF6FFF
G4	STM32G431xx/441xx	0x468	0xD3	0x20000000 - 0x20004000	0x1FFF0000 - 0x1FFF7000
	STM32G47xxx/48xxx	0x469	0xD4	0x20000000 - 0x20004000	0x1FFF0000 - 0x1FFF7000
H7	STM32H74xxx/75xxx	0x450	0x90	0x20004100 - 0x2001FFFF 0x24034000 - 0x2407FFFF	0x1FF00000 - 0x1FF1E7FF

Table 130. Bootloader device-dependent parameters (continued)

STM32 series	Device	PID	BL ID	RAM memory	System memory
L0	STM32L01xxx/02xxx	0x457	0xC3	NA	0x1FF00000 - 0x1FF00FFF
	STM32L031xx/041xx	0x425	0xC0	0x20001000 - 0x20001FFF	0x1FF00000 - 0x1FF00FFF
	STM32L05xxx/06xxx	0x417	0xC0	0x20001000 - 0x20001FFF	0x1FF00000 - 0x1FF00FFF
	STM32L07xxx/08xxx	0x447	0x41	0x20001000 - 0x20004FFF	0x1FF00000 - 0x1FF01FFF
	0xB2		0x20001400 - 0x20004FFF		
L1	STM32L1xxx6(8/B)	0x416	0x20	0x20000800 - 0x20003FFF	0x1FF00000 - 0x1FF01FFF
	STM32L1xxx6(8/B)A	0x429	0x20	0x20001000 - 0x20007FFF	
	STM32L1xxxC	0x427	0x40		
	STM32L1xxxD	0x436	0x45	0x20001000 - 0x2000BFFF	
	STM32L1xxxE	0x437	0x40	0x20001000 - 0x20013FFF	
L4	STM32L412xx/422xx	0x464	0xD1	0x20000000 - 0x200020FF	0x1FFF0000 - 0x1FFF6FFF
	STM32L43xxx/44xxx	0x435	0x91	0x20003100 - 0x2000BFFF	0x1FFF0000 - 0x1FFF6FFF
	STM32L45xxx/46xxx	0x462	0x92	0x20003100 - 0x2001FFFF	0x1FFF0000 - 0x1FFF6FFF
	STM32L47xxx/48xxx	0x415	0xA3	0x20003000 - 0x20017FFF	0x1FFF0000 - 0x1FFF6FFF
			0x92	0x20003100 - 0x20017FFF	
	STM32L496xx/4A6xx	0x461	0x93	0x20003100 - 0x2003FFFF	0x1FFF0000 - 0x1FFF6FFF
STM32L4Rxx/4Sxx	0x470	0x92	0x20003200 - 0x2009FFFF	0x1FFF0000 - 0x1FFF6FFF	
L5	STM32L552xx/562xx	0x472	0x91	0x20000000 - 0x20004000	0x0BF90000 - 0x0BF97FFF
WB	STM32WB50xx/WB55xx	0x495	0xD5	0x20000000 - 0x20005000	0x1FFF0000 - 0x1FFF7000

62 Bootloader timing

This section presents the typical timings of the bootloader firmware that should be used to ensure correct synchronization between host and STM32 device.

Two types of timings will be described herein:

- STM32 device bootloader resources initialization duration.
- Communication interface selection duration.

After these timings the bootloader is ready to receive and execute host commands.

62.1 Bootloader Startup timing

After bootloader reset, the host should wait until the STM32 bootloader is ready to start detection phase with a specific interface communication. This time corresponds to bootloader startup timing, during which resources used by bootloader are initialized.

Figure 82. Bootloader Startup timing description

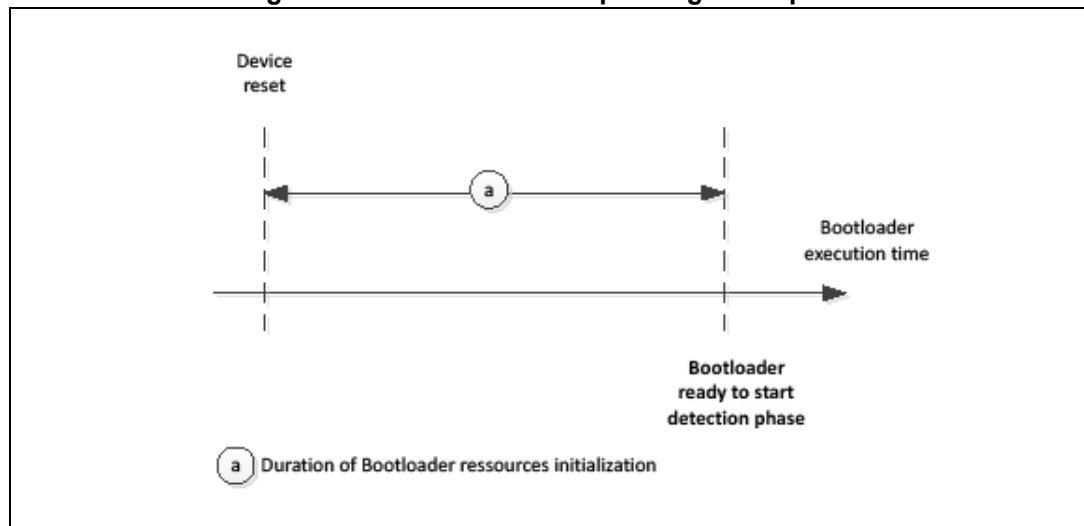

The table below contains the minimum startup timing for each STM32 product:

Table 131. Bootloader startup timings of STM32 devices

Device	Minimum bootloader Startup (ms)	HSE Timeout (ms)
STM32F03xx4/6	1.612	NA
STM32F05xxx and STM32F030x8 devices	1.612	NA
STM32F04xxx	0.058	NA
STM32F071xx/072xx	0.058	NA
STM32F070x6	HSE connected	3
	HSE not connected	230
		200

Table 131. Bootloader startup timings of STM32 devices (continued)

Device		Minimum bootloader Startup (ms)	HSE Timeout (ms)
STM32F070xB	HSE connected	6	200
	HSE not connected	230	
STM32F09xxx		2	NA
STM32F10xxx		1.227	NA
STM32F105xx/107xx	PA9 pin low	1.396	NA
	PA9 pin high	524.376	
STM32F10xxx XL-density		1.227	NA
STM32F2xxxx	V2.x	134	NA
	V3.x	84.59	0.790
STM32F301xx/302x4(6/8)	HSE connected	45	560.5
	HSE not connected	560.8	
STM32F302xB(C)/303xB(C)	HSE connected	43.4	2.236
	HSE not connected	2.36	
STM32F302xD(E)/303xD	HSE connected	7.53	NA
	HSE not connected	146.71	NA
STM32F303x4(6/8)/334xx/328xx		0.155	NA
STM32F318xx		0.182	NA
STM32F358xx		1.542	NA
STM32F373xx	HSE connected	43.4	2.236
	HSE not connected	2.36	
STM32F378xx		1.542	NA
STM32F398xx		1.72	NA
STM32F40xxx/41xxx	V3.x	84.59	0.790
	V9.x	74	96
STM32F401xB(C)		74.5	85
STM32F401xD(E)		74.5	85
STM32F410xx		0.614	NA
STM32F411xx		74.5	85
STM32F412xx		0.614	180
STM32F413xx/423xx		0.642	165
STM32F429xx/439xx	V7.x	82	97
	V9.x	74	97
STM32F446xx		73.61	96

Table 131. Bootloader startup timings of STM32 devices (continued)

Device		Minimum bootloader Startup (ms)	HSE Timeout (ms)
STM32F469xx/479xx		73.68	230
STM32F72xxx/73xxx		17.93	50
STM32F74xxx/75xxx		16.63	50
STM32G03xxx/04xxx		0.390	NA
STM32G07xxx/08xxx		0.390	NA
STM32G4xxxx		0.390	NA
STM32H74xxx/75xxx		53.975	2
STM32L01xxx/02xxx		0.63	NA
STM32L031xx/041xx		0.62	NA
STM32L05xxx/06xxx		0.22	NA
STM32L07xxx/08xxx	V4.x	0.61	NA
	V11.x	0.71	NA
STM32L1xxx6(8/B)A		0.542	NA
STM32L1xxx6(8/B)		0.542	NA
STM32L1xxxC		0.708	80
STM32L1xxxD		0.708	80
STM32L1xxxE		0.708	200
STM32L43xxx/44xxx		0.3335	100
STM32L45xxx/46xxx		50.93	NA
STM32L47xxx/48xxx	V10.x	LSE connected	55
		LSE not connected	2560
	V9.x	LSE connected	55.40
		LSE not connected	2560.51
STM32L412xx/422xx		0.12	NA
STM32L496xx/4A6xx		76.93	100
STM32L4Rxx/4Sxx		NA	NA
STM32L552xx/562xx		0.390	NA
STM32WB50xx/55xx		0.390	NA

62.2 USART connection timing

USART connection timing is the time that the host should wait for between sending the synchronization data (0x7F) and receiving the first acknowledge response (0x79).

Figure 83. USART connection timing description

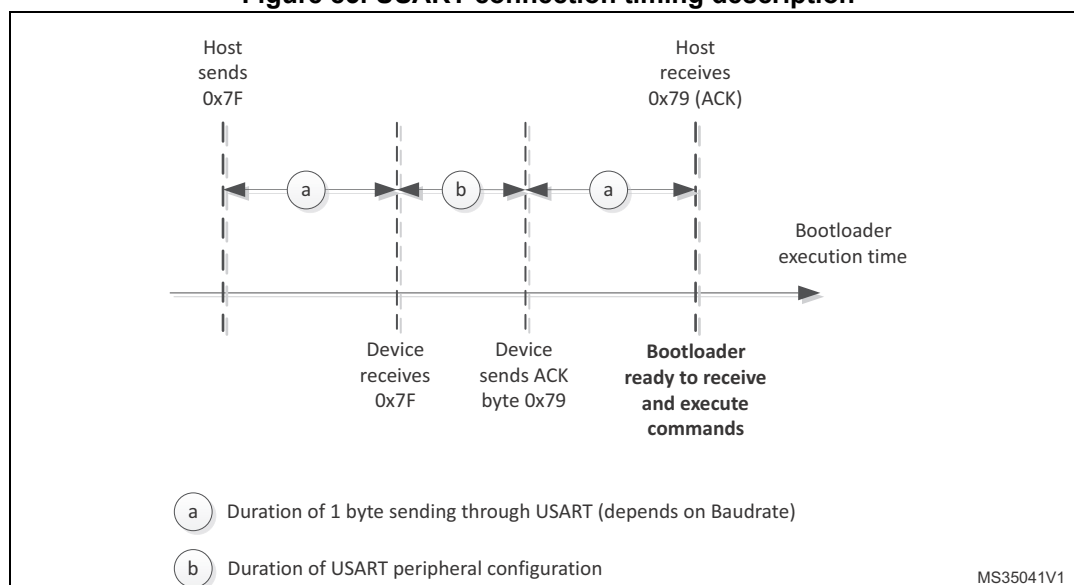

1. Receiving any other character different from 0x7F (or line glitches) will cause bootloader to start communication using a wrong baudrate. Bootloader measures the signal length between rising edge of first 1 bit in 0x7F to the falling edge of the last 1 bit in 0x7F to deduce the baudrate value
2. Bootloader does not re-align the calculated baudrate to standard baudrate values (ie. 1200, 9600, 115200, ...).

Note: For STM32F105xx/107xx line devices, PA9 pin (USB_VBUS) is used to detect the USB host connection. The initialization of USB peripheral is performed only if PA9 is high at detection phase which means that a host is connected to the port and delivering 5 V on the USB bus. When PA9 level is high at detection phase, more time is required to initialize and shutdown the USB peripheral. To minimize bootloader detection time when PA9 pin is not used, keep PA9 state low during USART detection phase from the moment the device is reset till a device ACK is sent.

Table 132. USART bootloader minimum timings of STM32 devices

Device	One USART byte sending (ms)	USART configuration (ms)	USART connection (ms)
STM32F03xx4/6	0.078125	0.0064	0.16265
STM32F05xxx and STM32F030x8 devices	0.078125	0.0095	0.16575
STM32F04xxx	0.078125	0.007	0.16325
STM32F071xx/072xx	0.078125	0.007	0.16325
STM32F070x6	0.078125	0.014	0.17
STM32F070xB	0.078125	0.08	0.23

Table 132. USART bootloader minimum timings of STM32 devices (continued)

Device		One USART byte sending (ms)	USART configuration (ms)	USART connection (ms)
STM32F09xxx		0.078125	0.07	0.22
STM32F10xxx		0.078125	0.002	0.15825
STM32F105xx/107xx	PA9 pin low	0.078125	0.007	0.16325
	PA9 pin High		105	105.15625
STM32F10xxx XL-density		0.078125	0.006	0.16225
STM32F2xxxx	V2.x	0.078125	0.009	0.16525
	V3.x			
STM32F301xx/302x4(6/8)	HSE connected	0.078125	0.002	0.15825
	HSE not connected			
STM32F302xB(C)/303xB(C)	HSE connected	0.078125	0.002	0.15825
	HSE not connected			
STM32F302xD(E)/303xD		0.078125	0.002	0.15885
STM32F303x4(6/8)/334xx/328xx		0.078125	0.002	0.15825
STM32F318xx		0.078125	0.002	0.15825
STM32F358xx		0.15625	0.001	0.3135
STM32F373xx	HSE connected	0.078125	0.002	0.15825
	HSE not connected			
STM32F378xx		0.15625	0.001	0.3135
STM32F398xx		0.078125	0.002	0.15885
STM32F40xxx/41xxx	V3.x	0.078125	0.009	0.16525
	V9.x		0.0035	0.15975
STM32F401xB(C)		0.078125	0.00326	0.15951
STM32F401xD(E)		0.078125	0.00326	0.15951
STM32F410xx		0.078125	0.002	0.158
STM32F411xx		0.078125	0.00326	0.15951
STM32F412xx		0.078125	0.002	0.158
STM32F413xx/423xx		0.078125	0.002	0.158
STM32F429xx/439xx	V7.x	0.078125	0.007	0.16325
	V9.x		0.00326	0.15951
STM32F446xx		0.078125	0.004	0.16
STM32F469xx/479xx		0.078125	0.003	0.159
STM32F72xxx/73xxx		0.078125	0.070	0.22
STM32F74xxx/75xxx		0.078125	0.065	0.22

Table 132. USART bootloader minimum timings of STM32 devices (continued)

Device		One USART byte sending (ms)	USART configuration (ms)	USART connection (ms)
STM32G03xxx/04xxx		0.078125	0.01	0.11
STM32G07xxx/08xxx		0.078125	0.01	0.11
STM32G4xxxx		0.078125	0.003	0.159
STM32H74xxx/75xxx		0.078125	0.072	0.22825
STM32L01xxx/02xxx		0.078125	0.016	0.17
STM32L031xx/041xx		0.078125	0.018	0.174
STM32L05xxx/06xxx		0.078125	0.018	0.17425
STM32L07xxx/08xxx	V4.x	0.078125	0.017	0.173
	V11.x	0.078125	0.017	0.158
STM32L1xxx6(8/B)A		0.078125	0.008	0.16425
STM32L1xxx6(8/B)		0.078125	0.008	0.16425
STM32L1xxxC		0.078125	0.008	0.16425
STM32L1xxxD		0.078125	0.008	0.16425
STM32L1xxxE		0.078125	0.008	0.16425
STM32L412xx/422xx		0.078125	0.005	0.2
STM32L43xxx/44xxx		0.078125	0.003	0.159
STM32L45xxx/46xxx		0.078125	0.07	0.22
STM32L47xxx/48xxx	V10.x	0.078125	0.003	0.159
	V9.x	0.078125	0.003	0.159
STM32L496xx/4A6xx		0.078125	0.003	0.159
STM32L4Rxx/4Sxx		NA	NA	NA
STM32L552xx/562xx		0.078125	0.01	0.11
STM32WB50xx/55xx		0.078125	0.003	0.159

62.3 USB connection timing

USB connection timing is the time that the host should wait for between plugging the USB cable and establishing a correct connection with the device. This timing includes enumeration and DFU components configuration. USB connection depends on the host.

Figure 84. USB connection timing description

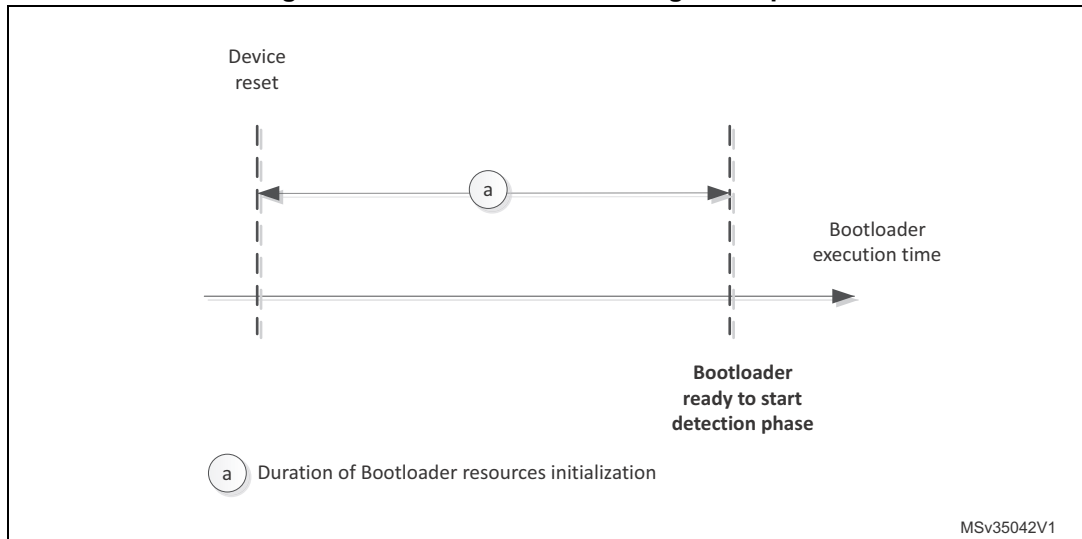

Note: For STM32F105xx/107xx devices, if the external HSE crystal frequency is different from 25 MHz (14.7456 MHz or 8 MHz), the device performs several unsuccessful enumerations (with connect – disconnect sequences) before being able to establish a correct connection with the host. This is due to the HSE automatic detection mechanism based on Start Of Frame (SOF) detection.

Table 133. USB bootloader minimum timings of STM32 devices

Device		USB connection (ms)
STM32F04xxx		350
STM32F070x6		TBD
STM32F070xB		320
STM32F105xx/107xx	HSE = 25 MHz	460
	HSE = 14.7465 MHz	4500
	HSE = 8 MHz	13700
STM32F2xxxx		270
STM32F301xx/302x4(6/8)		300
STM32F302xB(C)/303xB(C)		300
STM32F302xD(E)/303xD		100
STM32F373xx		300
STM32F40xxx/41xxx	V3.x	270
	V9.x	250
STM32F401xB(C)		250
STM32F401xD(E)		250
STM32F411xx		250
STM32F412xx		380
STM32F413xx/423xx		350

Table 133. USB bootloader minimum timings of STM32 devices (continued)

Device		USB connection (ms)
STM32F429xx/439xx	V7.x	250
	V9.x	
STM32F446xx		200
STM32F469xx/479xx		270
STM32F72xxx/73xxx		320
STM32F74xxx/75xxx		230
STM32G4xxxx		300
STM32H74xxx/75xxx		53.9764
STM32L07xxx/08xxx		140
STM32L1xxxC		849
STM32L1xxxD		849
STM32L412xx/422xx		820
STM32L43xxx/44xxx		820
STM32L45xxx/46xxx		330
STM32L47xxx/48xxx	V10.x	300
	V9.x	
STM32L496xx/4A6xx		430
STM32L4Rxx/4Sxx		NA
STM32L552xx/L562xx		300
STM32WB50xx/55xx		300

62.4 I2C connection timing

I2C connection timing is the time that the host should wait for between sending I2C device address and sending command code. This timing includes I2C line stretching duration.

Figure 85. I2C connection timing description

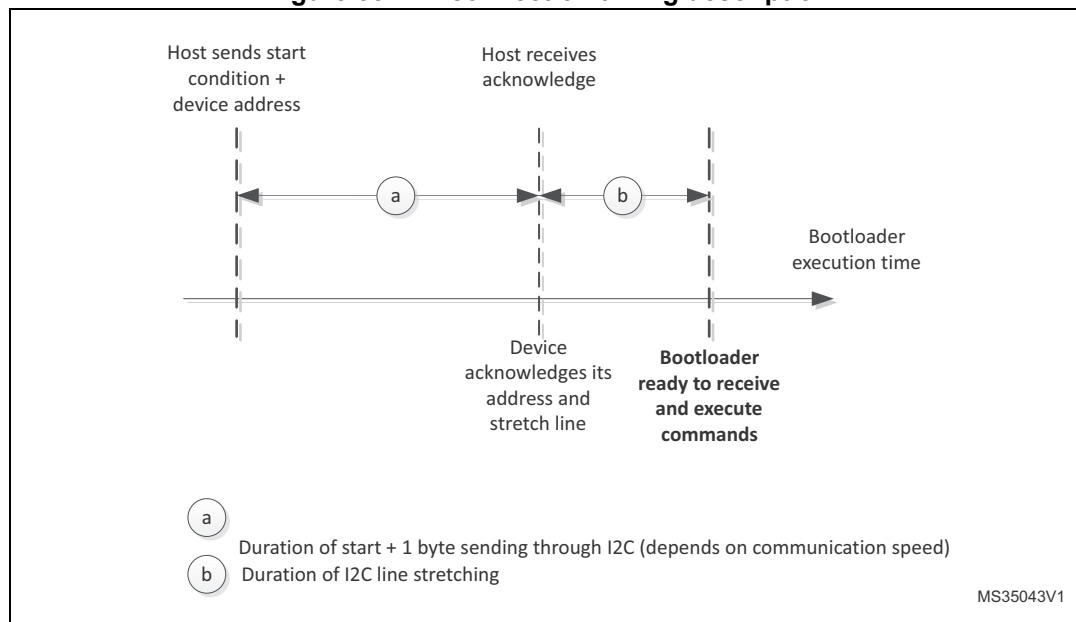

Note: For I2C communication, a timeout mechanism is implemented and it must be respected to execute bootloader commands correctly. This timeout is implemented between two I2C frames in the same command (eg: for Write memory command a timeout is inserted between command sending frame and address memory sending frame). Also the same timeout period is inserted between two successive data reception or transmission in the same I2C frame. If the timeout period is elapsed a system reset is generated to avoid bootloader crash.

In erase memory command and read-out unprotect command, the duration of flash operation should be taken into consideration when implementing the host side. After sending the code of pages to be erased, the host should wait until the bootloader device performs page erasing to complete the remaining steps of erase command.

Table 134. I2C bootloader minimum timings of STM32 devices

Device	Start condition + one I2C byte sending (ms)	I2C line stretching (ms)	I2C connection (ms)	I2C Timeout (ms)
STM32F04xxx	0.0225	0.0025	0.0250	1000
STM32F070x6	0.0225	0.0025	0.0245	1000
STM32F070xB	0.0225	0.0025	0.0245	1000
STM32F071xx/072xx	0.0225	0.0025	0.0250	1000
STM32F09xxx	0.0225	0.0025	0.0245	1000
STM32F303x4(6/8)/334xx/328xx	0.0225	0.0027	0.0252	1000

Table 134. I2C bootloader minimum timings of STM32 devices (continued)

Device	Start condition + one I2C byte sending (ms)	I2C line stretching (ms)	I2C connection (ms)	I2C Timeout (ms)	
STM32F318xx	0.0225	0.0027	0.0252	1000	
STM32F358xx	0.0225	0.0055	0.0280	10	
STM32F378xx	0.0225	0.0055	0.0280	10	
STM32F398xx	0.0225	0.0020	0.0245	1500	
STM32F40xxx/41xxx	0.0225	0.0022	0.0247	1000	
STM32F401xB(C)	0.0225	0.0022	0.0247	1000	
STM32F401xD(E)	0.0225	0.0022	0.0247	1000	
STM32F410xx	0.0225	0.0020	0.0245	1000	
STM32F411xx	0.0225	0.0022	0.0247	1000	
STM32F412xx	0.0225	0.0020	0.0245	1000	
STM32F413xx/423xx	0.0225	0.0020	0.0245	1000	
STM32F42xxx/43xxx	V7.x	0.0225	0.0033	0.0258	1000
	V9.x	0.0225	0.0022	0.0247	1000
STM32F446xx	0.0225	0.0020	0.0245	1000	
STM32F469xx/479xx	0.0225	0.0020	0.0245	1000	
STM32F72xxx/73xxx	0.0225	0.0020	0.0245	1000	
STM32F74xxx/75xxx	0.0225	0.0020	0.0245	500	
STM32G03xxx/04xxx	0.0225	0.0020	0.0245	1000	
STM32G07xxx/08xxx	0.0225	0.0020	0.0245	1000	
STM32G4xxxx	0.0225	0.0020	0.0245	1000	
STM32H74xxx/75xxx	0.0225	0.05	0.0725	1000	
STM32L07xxx/08xxx	0.0225	0.0020	0.0245	1000	
STM32L412xx/422xx	0.0225	0.0020	0.0245	1000	
STM32L43xxx/44xxx	0.0225	0.0020	0.0245	1000	
STM32L45xxx/46xxx	0.0225	0.0020	0.0245	1000	
STM32L47xxx/48xxx	V10.x	0.0225	0.0020	0.0245	1000
	V9.x	0.0225	0.0020	0.0245	1000
STM32L496xx/4A6xx	0.0225	0.0020	0.0245	1000	
STM32L4Rxx/4Sxx	NA	NA	NA	NA	
STM32L552xx/L562xx	0.0225	0.0020	0.0245	1000	
STM32WB50xx/55xx	0.0225	0.0020	0.0245	1000	

62.5 SPI connection timing

SPI connection timing is the time that the host should wait for between sending the synchronization data (0xA5) and receiving the first acknowledge response (0x79).

Figure 86. SPI connection timing description

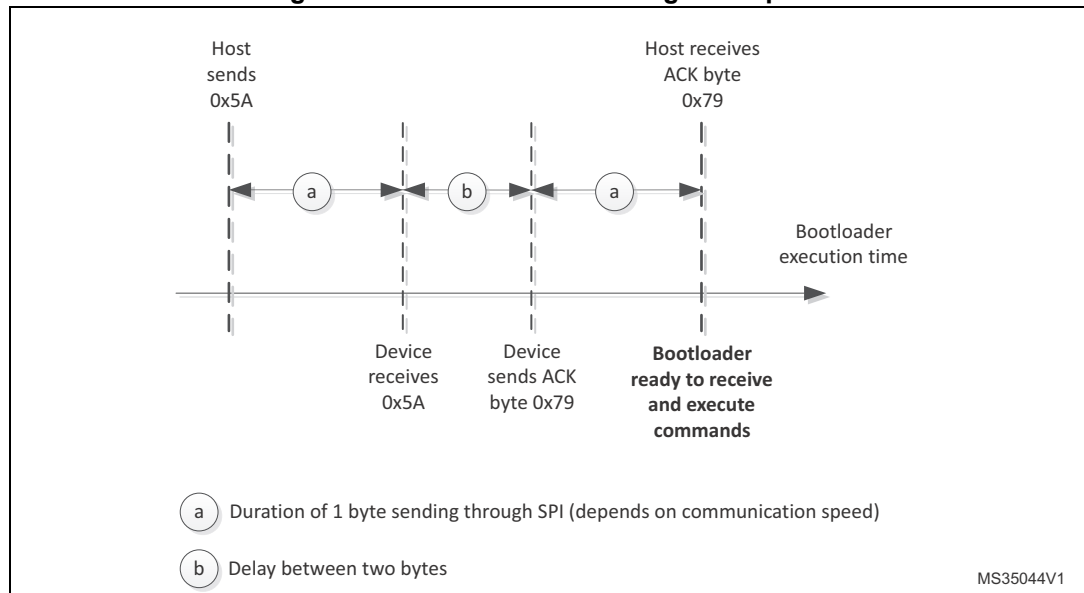

Table 135. SPI bootloader minimum timings of STM32 devices

Device	One SPI byte sending (ms)	Delay between two bytes (ms)	SPI connection (ms)
All products	0.001	0.008	0.01

63 Revision history

Table 136. Document revision history

Date	Revision	Changes
22-Oct-2007	1	Initial release.
22-Jan-2008	2	All STM32 in production (rev. B and rev. Z) include the bootloader described in this application note. Modified: Section 3.1: Bootloader activation and Section 1.4: Bootloader code sequence . Added: Section 1.3: Hardware requirements , Section 1.5: Choosing the USART baud rate , Section 1.6: Using the bootloader and Section: Note 2 linked to Get, Get Version & Read Protection Status and Get ID commands in Table 3: Bootloader commands , Note 3 added. Notion of “permanent” (Permanent Write Unprotect/Readout Protect/Unprotect) removed from document. Small text changes. Bootloader version upgraded to 2.0.
26-May-2008	3	Small text changes. RAM and System memory added to Table : The system clock is derived from the embedded internal high-speed RC, no external quartz is required for the bootloader execution . Section 1.6: Using the bootloader on page 8 removed. Erase modified, Note 3 modified and Note 1 added in Table 3: Bootloader commands on page 9 . Byte 3: on page 11 modified. Byte 2: on page 13 modified. Byte 2:, Bytes 3-4: and Byte 5: on page 15 modified, Note 3 modified. Byte 8: on page 18 modified. Notes added to Section 2.5: Go command on page 18 . Figure 11: Go command: device side on page 20 modified. Note added in Section 2.6: Write Memory command on page 21 . Byte 8: on page 24 modified. Figure 14: Erase Memory command: host side and Figure 15: Erase Memory command: device side modified. Byte 3: on page 26 modified. Table 3: Bootloader commands on page 9 . Note modified and note added in Section 2.8: Write Protect command on page 27 . Figure 16: Write Protect command: host side , Figure 17: Write Protect command: device side , Figure 19: Write Unprotect command: device side , Figure 21: Readout Protect command: device side and Figure 23: Readout Unprotect command: device side modified.
29-Jan-2009	4	This application note also applies to the STM32F102xx microcontrollers. Bootloader version updated to V2.2 (see Table 4: Bootloader versions).

Table 136. Document revision history (continued)

Date	Revision	Changes
19-Nov-2009	5	<p>IWDG added to Table : The system clock is derived from the embedded internal high-speed RC, no external quartz is required for the bootloader execution. Note added.</p> <p>BL changed bootloader in the entire document.</p> <p>Go command description modified in Table : The system clock is derived from the embedded internal high-speed RC, no external quartz is required for the bootloader execution.</p> <p>Number of bytes awaited by the bootloader corrected in Section 2.4: Read Memory command.</p> <p>Note modified below Figure 10: Go command: host side.</p> <p>Note removed in Section 2.5: Go command and note added.</p> <p>Start RAM address specified and note added in Section 2.6: Write Memory command. All options are erased when a Write Memory command is issued to the Option byte area.</p> <p>Figure 11: Go command: device side modified.</p> <p>Figure 13: Write Memory command: device side modified.</p> <p>Note added and bytes 3 and 4 sent by the host modified in Section 2.7: Erase Memory command.</p> <p>Note added to Section 2.8: Write Protect command.</p>
09-Mar-2010	6	<p>Application note restructured. Value line and connectivity line device bootloader added (Replaces AN2662).</p> <p>Introduction changed. Glossary added.</p>
20-Apr-2010	7	<p>Related documents: added XL-density line datasheets and programming manual.</p> <p>Glossary: added XL-density line devices.</p> <p>Table 3: added information for XL-density line devices.</p> <p>Section 4.1: Bootloader configuration: updated first sentence.</p> <p>Section 5.1: Bootloader configuration: updated first sentence.</p> <p>Added Section 6: STM32F10xxx XL-density devices bootloader.</p> <p>Table 65: added information for XL-density line devices.</p>
08-Oct-2010	8	<p>Added information for high-density value line devices in Table 3 and Table 65.</p>
14-Oct-2010	9	<p>Removed references to obsolete devices.</p>
26-Nov-2010	10	<p>Added information on ultralow power devices.</p>
13-Apr-2011	11	<p>Added information related to STM32F205/215xx and STM32F207/217xx devices.</p> <p>Added Section 32: Bootloader timing</p>
06-Jun-2011	12	<p>Updated:</p> <ul style="list-style-type: none"> – Table 12: STM32L1xxx6(8/B) bootloader versions – Table 17: STM32F2xxxx configuration in System memory boot mode – Table 18: STM32F2xxxx bootloader V2.x versions – Table 20: STM32F2xxxx bootloader V3.x versions
28-Nov-2011	13	<p>Added information related to STM32F405/415xx and STM32F407/417xx bootloader, and STM32F105xx/107xx bootloader V2.1.</p> <p>Added value line devices in Section 4: STM32F10xxx devices bootloader title and overview.</p>

Table 136. Document revision history (continued)

Date	Revision	Changes
30-Jul-2012	14	<p>Added information related to STM32F051x6/STM32F051x8 and to High-density ultralow power STM32L151xx, STM32L152xx bootloader.</p> <p>Added case of BOOT1 bit in Section 3.1: Bootloader activation.</p> <p>Updated Connectivity line, High-density ultralow power line, STM32F2xx and STM32F4xx in Table 3: Embedded bootloaders.</p> <p>Added bootloader version V2.2 in Table 8: STM32F105xx/107xx bootloader versions.</p> <p>Added bootloader V2.2 in Section 5.3.1: How to identify STM32F105xx/107xx bootloader versions.</p> <p>Added note related to DFU interface below Table 15: STM32L1xxxx high-density configuration in System memory boot mode. Added V4.2 bootloader know limitations and updated description, and added V4.5 bootloader in Table 16: STM32L1xxxx high-density bootloader versions.</p> <p>Added note related to DFU interface below Table 19: STM32F2xxxx configuration in System memory boot mode. Added V3.2 bootloader know limitations, and added V3.3 bootloader in Table 20: STM32F2xxxx bootloader V3.x versions. Updated STM32F2xx and STM32F4xx system memory end address in Table 21: STM32F40xxx/41xxx configuration in System memory boot mode.</p> <p>Added note related to DFU interface below Table 21: STM32F40xxx/41xxx configuration in System memory boot mode. Added V3.0 bootloader know limitations, and added V3.1 bootloader in Table 22: STM32F40xxx/41xxx bootloader V3.x version.</p> <p>Added bootloader V2.1 know limitations in Table 26: STM32F051xx bootloader versions.</p> <p>Updated STM32F051x6/x8 system memory end address in Table 65: Bootloader device-dependent parameters.</p> <p>Added Table 75: USART bootloader timings for high-density ultralow power devices, and Table 78: USART bootloader timings for STM32F051xx devices.</p> <p>Added Table 88: USB minimum timings for high-density ultralow power devices.</p>

Table 136. Document revision history (continued)

Date	Revision	Changes
24-Jan-2013	15	<p>Updated generic product names throughout the document (see Glossary).</p> <p>Added the following new sections:</p> <ul style="list-style-type: none"> – Section 8: STM32L1xxxC devices bootloader. – Section 13: STM32F031xx devices bootloader. – Section 14: STM32F373xx devices bootloader. – Section 15: STM32F302xB(C)/303xB(C) devices bootloader. – Section 16: STM32F378xx devices bootloader. – Section 17: STM32F358xx devices bootloader. – Section 18: STM32F427xx/437xx devices bootloader. – Section 34.3: I2C bootloader timing characteristics. <p>Updated Section 1: Related documents and Section 2: Glossary.</p> <p>Added Table 79 to Table 85 (USART bootloader timings).</p> <p>Replaced Figure 6 to Figure 16, and Figures 18, 19 and 42.</p> <p>Modified Tables 3, 5, 9, 11, 17, 20, 21, 22 to 13, 27, 29, 31, 33, 35, 37 and 65.</p> <p>Removed "X = 6: one USART is used" in Section 3.3: Hardware connection requirement.</p> <p>Replaced address 0x1FFFF 8002 with address 0x1FFF F802 in Section 12.1: Bootloader configuration.</p> <p>Modified procedure related to execution of the bootloader code in Note: on page 28, in Section 6.2: Bootloader selection and in Section 9.2: Bootloader selection.</p>
06-Feb-2013	16	<p>Added information related to I²C throughout the document.</p> <p>Streamlined Table 1: Applicable products and Section 1: Related documents.</p> <p>Modified Table 3: Embedded bootloaders as follows:</p> <ul style="list-style-type: none"> – Replaced "V6.0" with "V1.0" – Replaced "0x1FFFF7A6" with "0x1FFFF796" in row STM32F31xx – Replaced "0x1FFF7FA6" with "0x1FFFF7A6" in row STM32F051xx <p>Updated figures 6, 9 and 11.</p> <p>Added Note: in Glossary and Note: in Section 3.1: Bootloader activation.</p> <p>Replaced:</p> <ul style="list-style-type: none"> – "1.62 V" with "1.8 V" in tables 17, 19, 19, 22, 21, 27, 37 and 59 – "5 Kbyte" with "4 Kbyte" in row RAM of Table 33 – "127 pages (2 KB each)" with "4 KB (2 pages of 2 KB each)" in rows F3 of Table 65 – "The bootloader ID is programmed in the last two bytes of the device system memory" with "The bootloader ID is programmed in the last byte address - 1 of the device system memory" in Section 3.3: Hardware connection requirement. – "STM32F2xxxx devices revision Y" by "STM32F2xxxx devices revision X and Y" in Section 10: STM32F2xxxx devices bootloader – "Voltage Range 2" with "Voltage Range 1" in tables 11, 15 and 26.

Table 136. Document revision history (continued)

Date	Revision	Changes
21-May-2013	17	<p>Updated:</p> <ul style="list-style-type: none"> – Introduction – Section 2: Glossary – Section 3.3: Hardware connection requirement – Section 7: STM32L1xxx6(8/B) devices bootloader to include STM32L100 value line – Section 32.2: USART connection timing – Section 34.2: USB bootloader timing characteristics – Section 34.3: I2C bootloader timing characteristics – Table 1: Applicable products – Table 3: Embedded bootloaders – Table 25: STM32F051xx configuration in System memory boot mode – Table 27: STM32F031xx configuration in System memory boot mode – Table 65: Bootloader device-dependent parameters – Figure 17: Bootloader selection for STM32F031xx devices <p>Added Section 19: STM32F429xx/439xx devices bootloader.</p>
19-May-2014	18	<p>Add:</p> <ul style="list-style-type: none"> – Figure 1 to Figure 5, Figure 69, Figure 6, Figure 25, Figure 26, Figure 24, from Figure 38 to Figure 82, Figure 86 – Table 4, Table 110, Table 111, from Table 6 to Table 45, from Table 46 to Table 43, from Table 68 to Table 69, from Table to Table 135 – Section 38.4, Section 33.2, Section 62.1, Section 62.5 – Section 5, Section 23, Section 24, Section 22, from Section 17 to Section 56 – note under Figure 1, Figure 2, Figure 3 and Figure 4 <p>Updated:</p> <ul style="list-style-type: none"> – Updated starting from Section 4 to Section 7 and Section 18, Section 33 and Section 33 the chapter structure organized in three subsection: Bootloader configuration, Bootloader selection and Bootloader version. Updated Section 56 and Section 62 – Updated block diagram of Figure 25 and Figure 20. – Fixed I2C address for STM32F429xx/439xx devices in Table 66 – Table 1, Table 2, Table 3, Table 24, Table 104, Table 106, Table 108, Table 28, Table 30, Table 50, Table 130 – from Figure 14, to Figure 28, Figure 8, from Figure 82 to Figure 86 – note on Table 105

Table 136. Document revision history (continued)

Date	Revision	Changes
29-Jul-2014	19	<p>Updated:</p> <ul style="list-style-type: none"> – notes under Table 2 – Figure 68 and Figure 69 – Section 3: Glossary – replaced any reference to STM32F427xx/437xx with STM32F42xxx/43xxx on Section 33: STM32F42xxx/43xxx devices bootloader – replace any occurrence of ‘STM32F072xx’ with ‘STM32F07xxx’ – replace any occurrence of ‘STM32F051xx’ with ‘STM32F051xx and STM32F030x8 devices’. – comment field related to OTG_FS_DP and OTG_FS_DM on Table 24, Table 30, Table 50, Table 110, Table 66, Table 68, Table 12, Table 18, Table 54, Table 56 and Table 60 – comment field related to USB_DM on Table 110. – replace reference to "STM32F429xx/439xx" by "STM32F42xxx/43xxx" on Table 3 – comment field related to SPI2_MOSI, SPI2_MISO, SPI2_SCK and SPI2_NSS pins on Table 68 <p>Added:</p> <ul style="list-style-type: none"> – note under Table 2 – reference to STM32F411 on Table 1, Section 3: Glossary, Table 131, Table 132, Table 133, Table 134 – Section 30: STM32F411xx devices bootloader <p>Removed reference to STM32F427xx/437xx on Table 3, Section 3: Glossary, Table 130, Table 131, Table 132, Table 133</p>
24-Nov-2014	20	<p>Updated:</p> <ul style="list-style-type: none"> – comment in "SPI1_NSS pin" and "SPI2_NSS pin" rows on Table 110 and Table 96 – comment in "SPI1_NSS pin", "SPI2_NSS pin" and "SPI3_NSS pin" rows on Table 54, Table 56 and Table 60 – Figure 1
11-Mar-2015	21	<p>Updated:</p> <ul style="list-style-type: none"> – Table 1, Table 3, Table 22, Table 26, Table 104, Table 28, Table 30, Table 31, Table 50, Table 110, Table 10, Table 11, Table 6, Table 34, Table 66, Table 68, Table 12, Table 13, Table 18, Table 19, Table 32, Table 102, Table 118, Table 130, Table 131, Table 132, Table 133 and Table 134 – Figure 74 – Chapter 3: Glossary – Section 4.1 and Section 4.4 <p>Added:</p> <ul style="list-style-type: none"> – Section 56: STM32L47xxx/48xxx devices bootloader and Section 34: STM32F446xx devices bootloader

Table 136. Document revision history (continued)

Date	Revision	Changes
09-Jun-2015	22	Added: – Section 9: STM32F070x6 devices bootloader – Section 10: STM32F070xB devices bootloader – Section 12: STM32F09xxx devices bootloader – Section 19: STM32F302xD(E)/303xD(E) devices bootloader – Section 25: STM32F398xx devices bootloader – Section 36: STM32F72xxx/73xxx devices bootloader – Section 56.2: Bootloader V9.x – Notes 1 and 2 on Figure 83 Updated: – Table 1 – Section 3: Glossary – Table 2 – Table 3 – Section 4.4: Bootloader memory management – Table 130 , Table 131 , Table 132 , Table 133 and Table 134
29-Sep-2015	23	Added: – Section 29: STM32F410xx devices bootloader – Section 35: STM32F469xx/479xx devices bootloader – Section 45: STM32L031xx/041xx devices bootloader – Section 47: STM32L07xxx/08xxx devices bootloader Updated: – Table 1 – Section 3: Glossary – Table 3 – Figure 74 , Table 120 , Table 131 , Table 132 , Table 133 , Table 134
02-Nov-2015	24	Updated: – Table 1 , Table 3 , Table 130 , Table 131 , Table 132 , Table 133 , Table 134 – Section 35 Added: – Note on Section 26.2.1 – Section 31
01-Dec-2015	25	Updated: – Section 4.1 , Section 47 – Table 130
03-Mar-2016	26	Updated: – Table 1 , Table 3 , Table 63 , Table 99 , Table 101 , Table 130 – Section 3 , Section 47.1.1 , Section 47.2.1 , Section 56 Added: – Section 44: STM32L01xxx/02xxx devices bootloader – Figure 61 , Figure 63

Table 136. Document revision history (continued)

Date	Revision	Changes
21-Apr-2016	27	<p>Added:</p> <ul style="list-style-type: none"> – Section 38: STM32F76xxx/77xxx devices bootloader, Section 54: STM32L43xxx/44xxx devices bootloader. – Note on: Section 4.1: Bootloader activation, Section 8.1: Bootloader configuration, Section 9.1: Bootloader configuration, Figure 36: Dual Bank Boot Implementation for STM32F42xxx/43xxx Bootloader V7.x, Figure 38: Dual Bank Boot Implementation for STM32F42xxx/43xxx bootloader V9.x <p>Updated:</p> <ul style="list-style-type: none"> – Table 1: Applicable products, Table 2: Bootloader activation patterns, Table 8: STM32F030xC configuration in system memory boot mode, Table 14: STM32F070x6 configuration in system memory boot mode, Table 16: STM32F070xB configuration in system memory boot mode, Table 20: STM32F09xxx configuration in system memory boot mode, Table 32: STM32F301xx/302x4(6/8) configuration in system memory boot mode, Table 34: STM32F302xB(C)/303xB(C) configuration in system memory boot mode, Table 36: STM32F302xD(E)/303xD(E) configuration in system memory boot mode, Table 44: STM32F373xx configuration in system memory boot mode, Table 54: STM32F401xB(C) configuration in system memory boot mode, Table 56: STM32F401xD(E) configuration in system memory boot mode, Table 60: STM32F411xx configuration in system memory boot mode, Table 119: STM32L47xxx/48xxx bootloader V10.x versions, Table 121: STM32L47xxx/48xxx bootloader V9.x versions, Table 130: Bootloader device-dependent parameters – Section 3: Glossary,

Table 136. Document revision history (continued)

Date	Revision	Changes
05-Sep-2016	28	<p>Updated:</p> <ul style="list-style-type: none"> – Table 1: Applicable products, Table 8: STM32F030xC configuration in system memory boot mode, Table 10: STM32F05xxx and STM32F030x8 devices configuration in system memory boot mode, Table 12: STM32F04xxx configuration in system memory boot mode, Table 14: STM32F070x6 configuration in system memory boot mode, Table 16: STM32F070xB configuration in system memory boot mode, Table 18: STM32F071xx/072xx configuration in system memory boot mode, Table 20: STM32F09xxx configuration in system memory boot mode, Table 24: STM32F105xx/107xx configuration in system memory boot mode, Table 26: STM32F10xxx XL-density configuration in system memory boot mode, Table 28: STM32F2xxxx configuration in system memory boot mode, Table 30: STM32F2xxxx configuration in system memory boot mode, Table 32: STM32F301xx/302x4(6/8) configuration in system memory boot mode, Table 34: STM32F302xB(C)/303xB(C) configuration in system memory boot mode, Table 36: STM32F302xD(E)/303xD(E) configuration in system memory boot mode, Table 38: STM32F303x4(6/8)/334xx/328xx configuration in system memory boot mode, Table 40: STM32F318xx configuration in system memory boot mode, Table 42: STM32F358xx configuration in system memory boot mode, Table 44: STM32F373xx configuration in system memory boot mode, Table 46: STM32F378xx configuration in system memory boot mode, Table 48: STM32F398xx configuration in system memory boot mode, Table 50: STM32F40xxx/41xxx configuration in system memory boot mode, Table 52: STM32F40xxx/41xxx configuration in system memory boot mode, Table 54: STM32F401xB(C) configuration in system memory boot mode, Table 56: STM32F401xD(E) configuration in system memory boot mode, Table 60: STM32F411xx configuration in system memory boot mode, Table 66: STM32F42xxx/43xxx configuration in system memory boot mode, Table 68: STM32F42xxx/43xxx configuration in system memory boot mode, Table 70: STM32F446xx configuration in system memory boot mode, Table 72: STM32F469xx/479xx configuration in system memory boot mode, Table 76: STM32F74xxx/75xxx configuration in system memory boot mode, Table 78: STM32F74xxx/75xxx configuration in system memory boot mode, Table 96: STM32L05xxx/06xxx configuration in system memory boot mode, Table 102: STM32L1xxx6(8/B)A configuration in system memory boot mode, Table 104: STM32L1xxx6(8/B) configuration in system memory boot mode, Table 106: STM32L1xxxC configuration in system memory boot mode, Table 108: STM32L1xxxD configuration in system memory boot mode, Table 110: STM32L1xxxE configuration in system memory boot mode, Table 115: STM32L43xxx/44xxx bootloader versions, Table 118: STM32L47xxx/48xxx configuration in system memory boot mode, Table 130: Bootloader device-dependent parameters – Section 54.1: Bootloader configuration

Table 136. Document revision history (continued)

Date	Revision	Changes
05-Sep-2016	28 (continued)	<ul style="list-style-type: none"> – Figure 22: Bootloader selection for STM32F303x4(6/8)/334xx/328xx, Figure 23: Bootloader selection for STM32F318xx, Figure 25: Bootloader selection for STM32F373xx devices, Figure 26: Bootloader selection for STM32F378xx devices, Figure 29: Bootloader V9.x selection for STM32F40xxx/41xxx, Figure 32: Bootloader V11.x selection for STM32F410xx, Figure 34: Bootloader V9.x selection for STM32F412xx, Figure 42: Bootloader V9.x selection for STM32F469xx/479xx, Figure 47: Bootloader V9.x selection for STM32F76xxx/77xxx, Figure 64: Bootloader V11.x selection for STM32L07xxx/08xxx, Figure 74: Bootloader V10.x selection for STM32L47xxx/48xxx
07-Dec-2016	29	<p>Updated:</p> <ul style="list-style-type: none"> – Table 1: Applicable products, Section 3: Glossary, Section 4.1: Bootloader activation, Table 3: Embedded bootloaders, Table 12: STM32F09xxx devices bootloader, Table 14: STM32F105xx/107xx devices bootloader, Table 15: STM32F10xxx XL-density devices bootloader, Table 16: STM32F2xxxx devices bootloader, Table 17: STM32F301xx/302x4(6/8) devices bootloader, Table 18: STM32F302xB(C)/303xB(C) devices bootloader, Table 20: STM32F303x4(6/8)/334xx/328xx devices bootloader, Table 22: STM32F358xx devices bootloader, Table 25: STM32F398xx devices bootloader, Table 29: STM32F410xx devices bootloader, Table 32: STM32F413xx/423xx devices bootloader, Table 56: STM32F401xD(E) configuration in system memory boot mode, Section 14.3.1: How to identify STM32F105xx/107xx bootloader versions, Section 28.1: Bootloader configuration, Table 58: STM32F410xx configuration in system memory boot mode, Table 60: STM32F411xx configuration in system memory boot mode, Table 62: STM32F412xx configuration in system memory boot mode, Section 30.1: Bootloader configuration, Table 67: STM32F42xxx/43xxx bootloader V7.x versions, Table 69: STM32F42xxx/43xxx bootloader V9.x versions, Table 80: STM32F76xxx/77xxx configuration in system memory boot mode, Table 81: STM32F76xxx/77xxx bootloader V9.x versions, Table 93: STM32L01xxx/02xxx bootloader versions, Table 101: STM32L07xxx/08xxx bootloader V11.x versions, Table 114: STM32L43xxx/44xxx configuration in system memory boot mode, Table 115: STM32L43xxx/44xxx bootloader versions, Table 119: STM32L47xxx/48xxx bootloader V10.x versions, Table 130: Bootloader device-dependent parameters, Table 131: Bootloader startup timings of STM32 devices, Table 133: USB bootloader minimum timings of STM32 devices, Table 133: USB bootloader minimum timings of STM32 devices, Table 134: I2C bootloader minimum timings of STM32 devices <p>Added:</p> <ul style="list-style-type: none"> – Section 32: STM32F413xx/423xx devices bootloader

Table 136. Document revision history (continued)

Date	Revision	Changes
13-Mar-2017	30	<p>Updated:</p> <ul style="list-style-type: none"> – Table 1: Applicable products, Table 3: Embedded bootloaders, Table 11: STM32F05xxx and STM32F030x8 devices bootloader versions, Table 12: STM32F04xxx configuration in system memory boot mode, Table 13: STM32F04xxx bootloader versions, Table 15: STM32F070x6 bootloader versions, Table 17: STM32F070xB bootloader versions, Table 18: STM32F071xx/072xx configuration in system memory boot mode, Table 19: STM32F071xx/072xx bootloader versions, Table 20: STM32F09xxx configuration in system memory boot mode, Table 21: STM32F09xxx bootloader versions, Table 32: STM32F301xx/302x4(6/8) configuration in system memory boot mode, Table 35: STM32F302xB(C)/303xB(C) bootloader versions, Table 81: STM32F76xxx/77xxx bootloader V9.x versions, Table 92: STM32L01xxx/02xxx configuration in system memory boot mode, Table 115: STM32L43xxx/44xxx bootloader versions, Table 130: Bootloader device-dependent parameters, Table 120: STM32L47xxx/48xxx configuration in system memory boot mode, Table 131: Bootloader startup timings of STM32 devices, Table 132: USART bootloader minimum timings of STM32 devices, Table 133: USB bootloader minimum timings of STM32 devices, Table 134: I2C bootloader minimum timings of STM32 devices, Table 135: SPI bootloader minimum timings of STM32 devices – Section 3: Glossary, Section 6.1: Bootloader configuration, Section 14.3.3: USART bootloader Get-Version command returns 0x20 instead of 0x22, RPN reference in Section 54: STM32L43xxx/44xxx devices bootloader and in Section 56: STM32L47xxx/48xxx devices bootloader <p>Added Section 36: STM32F72xxx/73xxx devices bootloader and Section 57: STM32L496xx/4A6xx devices bootloader</p>

Table 136. Document revision history (continued)

Date	Revision	Changes
04-Jul-2017	31	<p>Updated:</p> <ul style="list-style-type: none"> – Table 1: Applicable products, Table 2: Bootloader activation patterns, Table 3: Embedded bootloaders, Table 25: STM32F105xx/107xx bootloader versions, Table 30: STM32F2xxx configuration in system memory boot mode, Table 34: STM32F302xB(C)/303xB(C) configuration in system memory boot mode, Table 42: STM32F358xx configuration in system memory boot mode, Table 44: STM32F373xx configuration in system memory boot mode, Table 46: STM32F378xx configuration in system memory boot mode, Table 52: STM32F40xxx/41xxx configuration in system memory boot mode, Table 54: STM32F401xB(C) configuration in system memory boot mode, Table 56: STM32F401xD(E) configuration in system memory boot mode, Table 60: STM32F411xx configuration in system memory boot mode, Table 66: STM32F42xxx/43xxx configuration in system memory boot mode, Table 70: STM32F446xx configuration in system memory boot mode, Table 72: STM32F469xx/479xx configuration in system memory boot mode, Table 74: STM32F72xxx/73xxx configuration in system memory boot mode, Table 76: STM32F74xxx/75xxx configuration in system memory boot mode, Table 78: STM32F74xxx/75xxx configuration in system memory boot mode, Table 90: STM32H74xxx/75xxx configuration in system memory boot mode, Table 106: STM32L1xxxC configuration in system memory boot mode, Table 108: STM32L1xxxD configuration in system memory boot mode, Table 110: STM32L1xxxE configuration in system memory boot mode, Table 116: STM32L45xxx/46xxx configuration in system memory boot mode, Table 130: Bootloader device-dependent parameters, Table 131: Bootloader startup timings of STM32 devices, Table 132: USART bootloader minimum timings of STM32 devices, Table 133: USB bootloader minimum timings of STM32 devices, Table 134: I2C bootloader minimum timings of STM32 devices – Introduction, Section 3: Glossary – Figure 71: Bootloader V9.x selection for STM32L43xxx/44xxx <p>Added:</p> <ul style="list-style-type: none"> – Section 43: STM32H74xxx/75xxx devices bootloader, Section 55: STM32L45xxx/46xxx devices bootloader
16-Feb-2018	32	<p>Updated Table 3: Embedded bootloaders, Table 91: STM32H74xxx/75xxx bootloader version, Table 122: STM32L496xx/4A6xx configuration in system memory boot mode, Table 123: STM32L496xx/4A6xx bootloader version, Table 130: Bootloader device-dependent parameters, Table 131: Bootloader startup timings of STM32 devices, Table 132: USART bootloader minimum timings of STM32 devices, Table 133: USB bootloader minimum timings of STM32 devices, Table 134: I2C bootloader minimum timings of STM32 devices.</p> <p>Added Section 58: STM32L4Rxxx/4Sxxx devices bootloader</p>
07-Aug-2018	33	<p>Updated Note: in Section 8.1: Bootloader configuration, Note: in Section 9.1: Bootloader configuration</p>

Table 136. Document revision history (continued)

Date	Revision	Changes
05-Nov-2018	34	<p>Updated Table 1: Applicable products, Table 51: STM32F40xxx/41xxx bootloader V3.x versions, Table 53: STM32F40xxx/41xxx bootloader V9.x versions, Table 55: STM32F401xB(C) bootloader versions, Table 57: STM32F401xD(E) bootloader versions, Table 59: STM32F410xx bootloader V11.x versions, Table 61: STM32F411xx bootloader versions, Table 63: STM32F412xx bootloader V9.x versions, Table 65: STM32F413xx/423xx bootloader V9.x versions, Table 67: STM32F42xxx/43xxx bootloader V7.x versions, Table 69: STM32F42xxx/43xxx bootloader V9.x versions, Table 71: STM32F446xx bootloader V9.x versions, Table 73: STM32F469xx/479xx bootloader V9.x versions, Table 75: STM32F72xxx/73xxx bootloader V9.x versions, Table 77: STM32F74xxx/75xxx bootloader V7.x versions, Table 79: STM32F74xxx/75xxx bootloader V9.x versions, Table 81: STM32F76xxx/77xxx bootloader V9.x versions, Table 130: Bootloader device-dependent parameters, Table 131: Bootloader startup timings of STM32 devices, Table 132: USART bootloader minimum timings of STM32 devices, Table 133: USB bootloader minimum timings of STM32 devices.</p> <p>Added Section 53: STM32L412xx/422xx devices bootloader</p>
06-Dec-2018	35	<p>Updated Table 1: Applicable products, Section 3: Glossary, Table 131: Bootloader startup timings of STM32 devices, Table 132: USART bootloader minimum timings of STM32 devices, Table 134: I2C bootloader minimum timings of STM32 devices.</p> <p>Added Section 40: STM32G07xxx/08xxx device bootloader</p>
21-Feb-2019	36	<p>Updated Table 1: Applicable products, Section 3: Glossary, Table 3: Embedded bootloaders, Table 130: Bootloader device-dependent parameters, Table 131: Bootloader startup timings of STM32 devices, Table 132: USART bootloader minimum timings of STM32 devices, Table 133: USB bootloader minimum timings of STM32 devices, Table 134: I2C bootloader minimum timings of STM32 devices.</p> <p>Added Section 60: STM32WB50xx/55xx devices bootloader</p>
06-May-2019	37	<p>Updated Table 1: Applicable products, Section 3: Glossary, Table 130: Bootloader device-dependent parameters, Table 131: Bootloader startup timings of STM32 devices, Table 132: USART bootloader minimum timings of STM32 devices, Table 133: USB bootloader minimum timings of STM32 devices, Table 134: I2C bootloader minimum timings of STM32 devices.</p> <p>Added Section 41: STM32G431xx/441xx devices bootloader, Section 42: STM32G47xxx/48xxx devices bootloader</p>

Table 136. Document revision history (continued)

Date	Revision	Changes
08-Jul-2019	38	<p>Updated:</p> <ul style="list-style-type: none"> – <i>Table 1: Applicable products, Table 2: Bootloader activation patterns, Table 3: Embedded bootloaders, Table 64: STM32F413xx/423xx configuration in system memory boot mode, Table 90: STM32H74xxx/75xxx configuration in system memory boot mode, Table 91: STM32H74xxx/75xxx bootloader version, Table 94: STM32L031xx/041xx configuration in system memory boot mode, Table 115: STM32L43xxx/44xxx bootloader versions, Table 116: STM32L45xxx/46xxx configuration in system memory boot mode, Table 123: STM32L496xx/4A6xx bootloader version, Table 129: STM32WB50xx/55xx bootloader versions, Table 130: Bootloader device-dependent parameters, Table 131: Bootloader startup timings of STM32 devices, Table 132: USART bootloader minimum timings of STM32 devices, Table 133: USB bootloader minimum timings of STM32 devices, Table 134: I2C bootloader minimum timings of STM32 devices</i> – <i>Section 3: Glossary, Section 4.1: Bootloader activation, Section 39.1: Bootloader configuration, Section 41.1: Bootloader configuration</i> – <i>Figure 57: Bootloader V9.x selection for STM32H74xxx/75xxx, Figure 78: Dual bank boot implementation for STM32L4Rxxx/STM32L4Sxxx bootloader V9.x</i> <p>Added <i>Note: in Section 4.2, Note: in Section 13.3, Note: in Section 43.1, Note: in Section 44.1, Section 39: STM32G03xxx/ STM32G04xxx devices bootloader</i></p>
16-Sep-2019	39	<p>Updated:</p> <ul style="list-style-type: none"> – <i>Table 1: Applicable products, Table 2: Bootloader activation patterns, Table 3: Embedded bootloaders, Table 83: STM32G03xx/04xxx bootloader versions, Table 113: STM32L412xx/422xx bootloader versions, Table 115: STM32L43xxx/44xxx bootloader versions, Table 117: STM32L45xxx/46xxx bootloader versions, Table 119: STM32L47xxx/48xxx bootloader V10.x versions, Table 121: STM32L47xxx/48xxx bootloader V9.x versions, Table 123: STM32L496xx/4A6xx bootloader version, Table 125: STM32L4Rxx/4Sxx bootloader versions, Table 130: Bootloader device-dependent parameters, Table 131: Bootloader startup timings of STM32 devices, Table 132: USART bootloader minimum timings of STM32 devices, Table 133: USB bootloader minimum timings of STM32 devices, Table 134: I2C bootloader minimum timings of STM32 devices</i> – <i>Section 3: Glossary, Section 4.2: Bootloader identification</i> <p>Added <i>Figure 56: Dual bank boot implementation for STM32G47xxx/48xxx bootloader V13.x, Section 59: STM32L552xx/STM32L562xx devices bootloader, note in Section 60.3: Bootloader version</i></p>
03-Oct-2019	40	<p>Updated <i>Table 3: Embedded bootloaders, Table 127: STM32L552xx/562xx bootloader versions, Table 129: STM32WB50xx/55xx bootloader versions</i></p>

IMPORTANT NOTICE – PLEASE READ CAREFULLY

STMicroelectronics NV and its subsidiaries (“ST”) reserve the right to make changes, corrections, enhancements, modifications, and improvements to ST products and/or to this document at any time without notice. Purchasers should obtain the latest relevant information on ST products before placing orders. ST products are sold pursuant to ST’s terms and conditions of sale in place at the time of order acknowledgement.

Purchasers are solely responsible for the choice, selection, and use of ST products and ST assumes no liability for application assistance or the design of Purchasers’ products.

No license, express or implied, to any intellectual property right is granted by ST herein.

Resale of ST products with provisions different from the information set forth herein shall void any warranty granted by ST for such product.

ST and the ST logo are trademarks of ST. For additional information about ST trademarks, please refer to www.st.com/trademarks. All other product or service names are the property of their respective owners.

Information in this document supersedes and replaces information previously supplied in any prior versions of this document.

© 2019 STMicroelectronics – All rights reserved