**STM32F0, STM32F1, STM32F2, STM32F4, STM32L1 series,
STM32F30x, STM32F3x8, STM32F373 lines timer overview**

Introduction

The purpose of this document: is detailed hereafter;

- Present an overview of the timer peripherals in the STM32F0, STM32F1, STM32F2, STM32F4 and STM32L1 microcontroller series, STM32F30x and STM32F3x8, STM32F37x microcontrollers lines. STM32F30x corresponds to STM32F301, STM32F302 and STM32F303 lines.
- Describe the various modes and specific features of the timers, such as clock sources.
- Explain how to use the available modes and features.
- Explain how to compute the time base in each configuration.
- Describe the timer synchronization sequences and the advanced features for motor control applications, in addition to the general-purpose timer modes.

For each mode, typical configurations are presented and examples of how to use the modes are provided.

In the rest of this document (unless otherwise specified), the term STM32xx is used to refer to the products listed in [Table 1](#).

Table 1. Applicable products

Type	Applicable products
Microcontrollers	STM32F0, STM32F1, STM32F2, STM32F4, STM32L1 series. STM32F301, STM32F302, STM32F303, STM32F3x8, STM32F373 lines.

Contents

- 1 Overview 6**
- 2 General-purpose timer modes 9**
 - 2.1 Clock input sources 9
 - 2.1.1 Internal clock 9
 - 2.1.2 External clock 9
 - 2.2 Time base generator 10
 - 2.3 Timer input capture mode 12
 - 2.4 Timer output compare mode 13
 - 2.5 Timer PWM mode 15
 - 2.6 Timer one pulse mode 16
 - 2.7 Timer Asymmetric PWM mode available for
STM32F30x and STM32F3x8 lines 16
 - 2.8 Timer combined PWM mode available for
STM32F30x and STM32F3x8 lines 18
 - 2.9 Retriggerable one pulse mode available for
STM32F30x and STM32F3x8 19
- 3 Timer synchronization 21**
 - 3.1 Timer system link 21
 - 3.2 Master configuration 21
 - 3.3 Slave configuration 23
- 4 Advanced features for motor control 24**
 - 4.1 Signal generation 24
 - 4.2 Combined three-phase PWM mode available for
STM32F30x and STM32F3x8 26
 - 4.3 Specific features for motor control applications 27
 - 4.3.1 Complementary signal and dead time feature 27
 - 4.3.2 Break input 28
 - 4.3.3 Locking mechanism 29
 - 4.3.4 Specific features for feedback measurement 30
- 5 Specific applications 34**

5.1	Infrared application	34
5.2	3-phase AC and PMSM control motor	34
5.3	Six-step mode	34
6	Revision history	36

List of tables

Table 1.	Applicable products	1
Table 2.	STM32 family timers	7
Table 3.	Timer features overview	8
Table 4.	Advanced timer configurations	25
Table 5.	Behavior of timer outputs versus Break1 and Break2 inputs	29
Table 6.	Locking levels	29
Table 7.	Document revision history	36

List of figures

Figure 1.	Asymmetric PWM mode versus center Aligned PWM mode	17
Figure 2.	Combined PWM mode	18
Figure 3.	Retriggerable OPM mode	20
Figure 4.	Timer system link	21
Figure 5.	Combined three-phase PWM	26
Figure 6.	Two signals are generated with insertion of a dead time	27
Figure 7.	Position at X4 resolution	30
Figure 8.	Position at X2 resolution	31
Figure 9.	Output waveform of a typical Hall sensor	32
Figure 10.	Commutation sequence	32

1 Overview

STM32 devices use various types of timers, with the following features for each:

- **General-purpose timers** are used in any application for output compare (timing and delay generation), one-pulse mode, input capture (for external signal frequency measurement), sensor interface (encoder, hall sensor)...
- **Advanced timers**: these timers have the most features. In addition to general purpose functions, they include several features related to motor control and digital power conversion applications: three complementary signals with deadtime insertion, emergency shut-down input.
- One or two **channel timers**: used as general-purpose timers with a limited number of channels.
- One or two channel timers with **complementary output**: same as previous type, but having a deadtime generator on one channel. This allows having complementary signals with a time base independent from the advanced timers.
- **Basic timers** have no input/outputs and are used either as timebase timers or for triggering the DAC peripheral.

[Table 2](#) summarizes the STM32 family timers.

[Table 3](#) presents a general overview of timer features.

Table 2. STM32 family timers

Timer type	STM32F0 series	STM32F101 /102/103/ 105/107 lines	STM32F100 value line	STM32L1 series	STM32F2 and STM32F4 series	STM32F30x and STM32F3x8	STM32F37x lines	
Advanced	TIM1	TIM1	TIM1	-	TIM1	TIM1	-	
	-	TIM8	-	-	TIM8	TIM8	-	
						TIM20 ⁽¹⁾		
General purpose	16-bit	-	TIM2	TIM2	TIM2	-	TIM2	
		TIM3	TIM3	TIM3	TIM3	TIM3	TIM3	
		-	TIM4	TIM4	TIM4	TIM4	TIM4	
		-	TIM5	TIM5	-	-	-	TIM5
	32-bit	-	-	-	-	-	-	TIM19
		TIM2	-	-	-	TIM2	TIM2	TIM2
Basic	-	-	-	-	-	-	TIM19	
	TIM2	-	-	-	TIM2	TIM2	TIM2	
	-	-	-	-	TIM5		TIM5	
Basic	TIM6	TIM6	TIM6	TIM6	TIM6	TIM6	TIM6	
	-	TIM7	TIM7	TIM7	TIM7	TIM7	TIM7	
	-	-	-	-	-	-	TIM18	
1-channel	-	TIM10	-	TIM10	TIM10	-	-	
	-	TIM11	-	TIM11	TIM11	-	-	
	-	TIM13	TIM13		TIM13	-	TIM13	
	TIM14	TIM14	TIM14		TIM14	-	TIM14	
2-channel	-	TIM9		TIM9	TIM9	-	-	
	-	TIM12	TIM12	-	TIM12	-	TIM12	
1-channel with one complementary output	TIM15	-	TIM15	-	-	TIM15	TIM15	
	-	-	-	-	-	-	-	
2-channel with one complementary output	TIM16	-	TIM16	-	-	TIM16	TIM16	
	TIM17	-	TIM17	-	-	TIM17	TIM17	

1. TIM20 is only available for STM32F303xDxE and STM32F398VE devices.

Note: STM32F30x and STM32F3x8 timers present several new modes: Asymmetric mode, combined mode, One retriggerable mode, combined 3 PWM mode and a second break input, these modes are available only for these families.

Table 3. Timer features overview

Timer type	Counter resolution	Counter type	DMA	Channels	Comp. channels	Synchronization	
						Master config.	Slave config.
Advanced	16 bit	up, down and center aligned	Yes	4	3	Yes	Yes
General-purpose	16 bit 32 bit ⁽¹⁾	up, down and center aligned	Yes	4	0	Yes	Yes
Basic	16 bit	up	Yes	0	0	Yes	No
1-channel	16 bit	up	No	1	0	Yes (OC signal)	No
2-channel	16 bit	up	No	2	0	Yes	Yes
1-channel with one complementary output	16 bit	up	Yes	1	1	Yes (OC signal)	No
2-channel with one complementary output	16 bit	up	Yes	2	1	No	Yes

1. TIM2 and TIM5 are 32-bit counter resolution in the STM32F2, STM32F4 series, STM32F303xB/C/D/E and STM32F3x8 devices.

2 General-purpose timer modes

General-purpose timers can be programmed to work in one of the following configurations.

2.1 Clock input sources

The timer can be synchronized by several clocks simultaneously:

- Internal clock
- External clock
 - External mode1 (TI1 or TI2 pins)
 - External clock mode2 (ETR pin)
 - Internal trigger clock (ITRx)

2.1.1 Internal clock

The timer is clocked by default by the internal clock provided from the RCC. To select this clock source, the SMCR_SMS (if present) bits should be reset.

2.1.2 External clock

The external clock timer is divided in two categories:

- External clock connected to TI1 or TI2 pins
- External clock connected to ETR pin

In these cases, the clock is provided by an external signal connected to TIx pins or ETR pin. The maximum external clock frequency should be verified.

- Note:*
- 1 *In addition to all these clock sources, the timer should be clocked with the APBx clock.*
 - 2 *The external clocks are not directly feeding the prescaler, but they are first synchronized with the APBx clock through dedicated logical blocks.*

External clock mode1 (TI1 or TI2 pins)

In this mode the external clock will be applied on timer input TI1 pin or TI2 pin. To do this:

1. Configure the timers to use the TIx pin as input:
 - a) Select the pin to be used by writing CCxS bits in the TIMx_CCMR1 register.
 - b) Select the polarity of the input:
For the STM32F100/101/102/103/105/107 lines: by writing CCxP in the TIMx_CCER register to select the rising or the falling edge;
For the other series & lines: by writing CCxP and CCxNP in the TIMx_CCER register to select the rising/falling edge, or both edges^(a).

a. For the STM32F100/101/102/103/105/107 lines, polarity selection for both edges can be achieved by using TI1F_ED, but only for TI1 input.

- c) Enable the corresponding channel by setting the CCEX bit in the TIMx_CCER register.
2. Select the timer Tlx as the trigger input source by writing TS bits in the TIMx_SMCR register.
3. Select the external clock mode1 by writing SMS=111 in the TIMx_SMCR register.

External clock mode2 (ETR pin)

The external clock mode2 uses the ETR pin as timer input clock. To use this feature:

1. Select the external clock mode2 by writing ECE = 1 in the TIMx_SMCR register.
2. Configure, if needed, the prescaler, the filter and the polarity by writing ETPS [1:0], ETF [3:0] and ETP in the TIMx_SMCR register.

Internal trigger clock (ITRx)

This is a particular mode of timer synchronization. When using one timer as a prescaler for another timer, the first timer update event or output compare signal is used as a clock for the second one.

2.2 Time base generator

The timer can be used as a time base generator. Depending on the clock, prescaler and auto reload, repetition counter (if present) parameters, the 16-bit timer can generate an update event from a nanosecond to a few minutes. For the 32-bit timer, the range is larger.

Example update event period

The update event period is calculated as follows:

$$\text{Update_event} = \text{TIM_CLK} / ((\text{PSC} + 1) * (\text{ARR} + 1) * (\text{RCR} + 1))$$

Where: TIM_CLK = timer clock input

PSC = 16-bit prescaler register

ARR = 16/32-bit Autoreload register

RCR = 16-bit repetition counter

TIM_CLK = 72 MHz

Prescaler = 1

Auto reload = 65535

No repetition counter RCR = 0

$$\text{Update_event} = 72 * 10^6 / ((1 + 1) * (65535 + 1) * (1))$$

$$\text{Update_event} = 549.3 \text{ Hz}$$

Example external clock mode2

In this mode, the update event period is calculated as follows:

$$\text{Update_event} = \text{ETR_CLK} / ((\text{ETR_PSC}) * (\text{PSC} + 1) * (\text{ARR} + 1) * (\text{RCR} + 1))$$

Where ETR_CLK = the external clock frequency connected to ETR pin.

ETR_CLK = 100 kHz

Prescaler = 1

ETR_PSC = 2

Autoreload = 255

Repetition counter = 2

$$\text{Update_event} = 100 * 103 / ((2 + 1) * (1 + 1) * ((255 + 1) * (2 + 1)))$$

$$\text{Update_event} = 21.7 \text{ Hz}$$

Example external clock mode1

In this mode, the update event period is calculated as follows:

$$\text{Update_event} = \text{TIx_CLK} / ((\text{PSC} + 1) * (\text{ARR} + 1) * (\text{RCR} + 1))$$

Where TIx_CLK = the external clock frequency connected to TI1 pin or TI2 pin.

TIx_CLK = 50 kHz

Prescaler = 1

Auto reload = 255

Repetition counter = 2

$$\text{Update_event} = 50\,000 / ((1 + 1) * ((255 + 1) * (2 + 1)))$$

$$\text{Update_event} = 32.55 \text{ Hz}$$

Example Internal trigger clock (ITRx) mode1

In this mode, the update event period is calculated as follows:

$$\text{Update_event} = \text{ITRx_CLK} / ((\text{PSC} + 1) * (\text{ARR} + 1) * (\text{RCR} + 1))$$

Where ITRx_CLK = the internal trigger frequency mapped to timer trigger input (TRGI)

ITRx_CLK = 8 kHz

Prescaler = 1

Auto reload = 255

Repetition counter = 1

$$\text{Update_event} = 8000 / ((1 + 1) * ((255 + 1) * (1 + 1)))$$

$$\text{Update_event} = 7.8 \text{ Hz}$$

Depending on the counter mode, the update event is generated each:

- Overflow, if up counting mode is used: the DIR bit is reset in TIMx_CR1 register
- Underflow, if down counting mode is used: the DIR bit is set in TIMx_CR1 register
- Overflow and underflow, if center aligned mode is used: the CMS bits are different from zero.

The update event is generated also by:

- Software, if the UG (update generation) bit is set in TIM_EGR register.
- Update generation through the slave mode controller

As the buffered registers (ARR, PSC, CCRx) need an update event to be loaded with their preload values, set the URS (Update Request Source) to 1 to avoid the update flag each time these values are loaded. In this case, the update event is only generated if the counter overflow/underflow occurs.

The update event can be also disabled by setting the bit UDIS (update disable) in the CR1 register. In this case, the update event is not generated, and shadow registers (ARR, PSC, CCRx) keep their value. The counter and the prescaler are reinitialized if the UG bit is set, or if a hardware reset is received from the slave mode controller.

An interrupt or/ and a DMA request can be generated when the UIE bit or/and UDE bit are set in the DIER register.

For more details on using the timer in this mode, refer to the examples provided in the STM32xx standard peripheral libraries in the /Project/STM32xx_StdPeriph_Examples/TIM/TimeBase folder.

STM32Cube F3 firmware package includes examples in the following directories:

- Projects\STM32F3348-Discovery\Examples\TIM\TIM_TimeBase,
- Projects\STM32F302R8-Nucleo\Examples\TIM\TIM_TimeBase,
- Projects\STM32F3-Discovery\Examples\TIM\TIM_TimeBase,
- Projects\STM32373C_EVAL\Examples\TIM\TIM_TimeBase,
- Projects\STM32303E_EVAL\Examples\TIM\TIM_TimeBase and
- Projects\STM32303C_EVAL\Examples\TIM\TIM_TimeBase

2.3 Timer input capture mode

The timer can be used in input capture mode to measure an external signal. Depending on timer clock, prescaler and timer resolution, the maximum measured period is deduced.

To use the timer in this mode:

1. Select the active input by setting the CCxS bits in CCMRx register. These bits should be different from zero, otherwise the CCRx register will be read only.
2. Program the filter by writing the IC1F[3:0] bits in the CCMRx register, and the prescaler by writing the IC1PSC[1:0] if needed.
3. Program the polarity by writing the CCxNP/CCxP bits to select between rising, falling or both edges.

The input capture module is used to capture the value of the counter after a transition is detected by the corresponding input channel. To get the external signal period, two consecutive captures are needed. The period is calculated by subtracting these two values.

$$\text{Period} = \text{Capture}(1) / (\text{TIMx_CLK} * (\text{PSC} + 1) * (\text{ICxPSC}) * \text{polarity_index}(2))$$

The capture difference between two consecutive captures CCRx_tn and CCRx_tn+1:

- If CCRx_tn < CCRx_tn+1: capture = CCRx_tn+1 - CCRx_tn
- If CCRx_tn > CCRx_tn+1: capture = (ARR_max - CCRx_tn) + CCRx_tn+1

The polarity index is 1 if the rising or falling edge is used, and 2 if both edges are used.

Particular case

To facilitate the input capture measurement, the timer counter is reset after each rising edge detected on the timer input channel by:

- selecting TlxFPx as the input trigger by setting the TS bits in the SMCR register
- selecting the reset mode as the slave mode by configuring the SMS bits in the SMCR register

Using this configuration, when an edge is detected, the counter is reset and the period of the external signal is automatically given by the value on the CCRx register. This method is used only with channel 1 or channel 2.

In this case, the input capture prescaler (ICPSC) is not considered in the period computation.

The period is computed as follows:

$$\text{Period} = \text{CCRx} / (\text{TIMx_CLK} * (\text{PSC} + 1) * \text{polarity_index}(1))$$

The polarity index is 1 if rising or falling edge is used, and 2 if both edges are used.

For more details on using the timer in this mode, refer to the examples provided in the STM32xx standard peripheral libraries in the /Project/STM32xx_StdPeriph_Examples/TIM/InputCapture folder.

STM32Cube F3 firmware package includes examples in the following directories:

- Projects\STM32F3-Discovery\Examples\TIM\TIM_InputCapture,
- Projects\STM32373C_EVAL\Examples\TIM\TIM_InputCapture,
- Projects\STM32303E_EVAL\Examples\TIM\TIM_InputCapture and
- Projects\STM32303C_EVAL\Examples\TIM\TIM_InputCapture

2.4 Timer output compare mode

To control an output waveform, or to indicate when a period of time has elapsed, the timer is used in one of the following output compare modes. The main difference between these modes is the output signal waveform.

- **Output compare timing:** The comparison between the output compare register CCRx and the counter CNT has no effect on the outputs. This mode is used to generate a timing base.
- **Output compare active:** Set the channel output to active level on match. The OCxRef signal is forced high when the counter (CNT) matches the capture/compare register (CCRx).
- **Output compare inactive:** Set channel to inactive level on match. The OCxRef signal is forced low when the counter (CNT) matches the capture/compare register (CCRx).
- **Output compare toggle:** OCxRef toggles when the counter (CNT) matches the capture/compare register (CCRx).
- **Output compare forced active/inactive:** OCREF is forced high (active mode) or low (inactive mode) independently from counter value.

To configure the timer in one of these modes:

1. Select the clock source.
2. Write the desired data in the ARR and CCRx registers.
3. Configure the output mode:
 - a) Select the output compare mode: timing / active / inactive / toggle.
 - b) In case of active, inactive and toggle modes, select the polarity by writing CCxP in CCER register.
 - c) Disable the preload feature for CCx by writing OCxPE in CCMRx register.
 - d) Enable the capture / compare output by writing CCxE in CCMRx register.
4. Enable the counter by setting the CEN bit in the TIMx_CR1 register.
5. Set the CCxIE / CCxDE bit if an interrupt / DMA request is to be generated.

Timer output compare timing / toggle update rate computation

CCx update rate = TIMx_Counter_CLK / CCRx

- If internal clock: $TIMx_Counter_CLK = TIM_CLK / (PSC + 1)$
- If external clock mode2: $TIMx_Counter_CLK = ETR_CLK / ((ETR_PSC) * (PSC + 1))$
- If external clock mode1: $TIMx_Counter_CLK = Tix_CLK / (PSC + 1)$
 - if ETRF used as clock source: $TRGI_CLK = ETR_CLK / ETR_PSC$
 - if TI1FP1 used as clock source: $TRGI_CLK = TI1_CLK / TI1_PSC$
 - if TI2FP2 used as clock source: $TRGI_CLK = TI2_CLK / TI2_PSC$
 - if TI1_ED used as clock source: $TRGI_CLK = TI1_ED_CLK$
 - if ITRx used as clock source: $TRGI_CLK = ITRx_CLK$

Timer output compare active/inactive delay computation

CCx_delay = CCRx / TIMx_Counter_CLK

- If internal clock: $TIMx_Counter_CLK = TIM_CLK / (PSC + 1)$
- If external clock mode2: $TIMx_Counter_CLK = ETR_CLK / ((ETR_PSC) * (PSC + 1))$
- If external clock mode1: $TIMx_Counter_CLK = Tix_CLK / (PSC + 1)$
 - if ETRF used as clock source: $TRGI_CLK = ETR_CLK / ETR_PSC$
 - if TI1FP1 used as clock source: $TRGI_CLK = TI1_CLK / TI1_PSC$
 - if TI2FP2 used as clock source: $TRGI_CLK = TI2_CLK / TI2_PSC$
 - if TI1_ED used as clock source: $TRGI_CLK = TI1_ED_CLK$
 - if ITRx used as clock source: $TRGI_CLK = ITRx_CLK$

For more details on using the timer in this mode, refer to the examples provided in the STM32xx standard peripheral libraries, in the /Project/STM32xx_StdPeriph_Examples/TIM/OC_Toggle, /OCActive and /OCInactive folders.

2.5 Timer PWM mode

The timer is able to generate PWM in edge-aligned mode or center-aligned mode independently on each channel, with a frequency determined by the value of the TIMx_ARR register, and a duty cycle determined by the value of the TIMx_CCRx register.

PWM mode 1

- In up-counting, channelx is active as long as $CNT < CCRx$, otherwise it is inactive.
- In down-counting, channelx is inactive as long as $CNT > CCRx$, otherwise it is active

PWM mode 2

- In up-counting, channelx is inactive as long as $CNT < CCRx$, otherwise it is active.
- In down-counting, channelx is active as long as $CNT > CCRx$, otherwise it is inactive.

Note: Active when $OCREF = 1$, inactive when $OCREF = 0$.

To configure the timer in this mode:

1. Configure the output pin:
 - a) Select the output mode by writing CCS bits in CCMRx register.
 - b) Select the polarity by writing the CCxP bit in CCER register.
2. Select the PWM mode (PWM1 or PWM2) by writing OCxM bits in CCMRx register.
3. Program the period and the duty cycle respectively in ARR and CCRx registers.
4. Set the preload bit in CCMRx register and the ARPE bit in the CR1 register.
5. Select the counting mode:
 - a) PWM edge-aligned mode: the counter must be configured up-counting or down-counting.
 - b) PWM center aligned mode: the counter mode must be center aligned counting mode (CMS bits different from '00').
6. Enable the capture compare.
7. Enable the counter.

For more details on using the timer in this mode, refer to the examples provided in the STM32xx standard peripheral libraries, in the /Project/STM32xx_StdPeriph_Examples/TIM/PWM_Output and /7PWM_Output folders.

STM32Cube F3 firmware package includes examples in the following directories:

- Projects\STM32F303RE-Nucleo\Examples\TIM\TIM_PWMOutput,
- Projects\STM32F302R8-Nucleo\Examples\TIM\TIM_PWMOutput,
- Projects\STM32F3-Discovery\Examples\TIM\TIM_PWMOutput,
- Projects\STM32373C_EVAL\Examples\TIM\TIM_PWMOutput,
- Projects\STM32303E_EVAL\Examples\TIM\TIM_PWMOutputand
- Projects\STM32303C_EVAL\Examples\TIM\TIM_PWMOutput

2.6 Timer one pulse mode

One pulse mode (OPM) is a particular case of the input capture mode and the output compare mode. It allows the counter to be started in response to a stimulus and to generate a pulse with a programmable length after a programmable delay.

To configure the timer this mode:

1. Configure the input pin and mode:
 - a) Select the TIxFPx trigger to be used by writing CCxS bits in CCMRx register.
 - b) Select the polarity of the input pin by writing CCxP and CCxNP bits in CCER register.
 - c) Configure the TIxFPx trigger for the slave mode trigger by writing TS bits in SMCR register.
 - d) Select the trigger mode for the slave mode by writing SMS = 110 in SMCR register.
2. Configure the output pin and mode:
 - a) Select the output polarity by writing CCyP bit in CCER register.
 - b) Select the output compare mode by writing OCyM bits in CCMRy register (PWM1 or PWM2 mode).
 - c) Set the delay value by writing in CCRy register.
 - d) Set the auto reload value to have the desired pulse: pulse = TIMy_ARR - TIMy_CCRy.
3. Select the one pulse mode by setting the OPM bit in CR1 register, if only one pulse is to be generated. Otherwise this bit should be reset.

$$\text{Delay} = \text{CCRy} / (\text{TIMx_CLK} / (\text{PSC} + 1))$$

$$\text{Pulse-Length} = (\text{ARR} - \text{CCRy}) / (\text{TIMx_CLK} / (\text{PSC} + 1))$$

For more details on using the timer in this mode, refer to the examples provided in the STM32xx standard peripheral libraries, in the /Project/STM32xx_StdPeriph_Examples/TIM/OnePulse folder.

2.7 Timer Asymmetric PWM mode available for STM32F30x and STM32F3x8 lines

The asymmetric mode allows generating a center-aligned PWM signals with a programmable phase shift. For a dedicated channel, the phase shift and the pulse length are programmed using the two TIMx_CCRx register (TIMx_CCR1 and TIMx_CCR2 or TIMx_CCR3 and TIMx_CCR4), the frequency is determined by the value of the TIMx_ARR register. So the asymmetric PWM mode can be selected independently on two channels by programming the OCxM bits in TIMx_CCMRx register:

- OCxM = 1110 to use the Asymmetric PWM1, in this mode the output reference has the same behavior as in PWM1 mode. When the counter is counting up the output reference is identical to OC1/3REF, when the counter is down counting, the output reference is identical to OC2/4REF
- OCxM = 1111 to use the Asymmetric PWM2, in this mode the output reference has the same behavior as in PWM2 mode. When the counter is counting up the output reference is identical to OC1/3REF, when the counter is down counting, the output reference is identical to OC2/4REF

The following figure resumes the asymmetric behavior versus the center aligned PWM mode

Figure 1. Asymmetric PWM mode versus center Aligned PWM mode

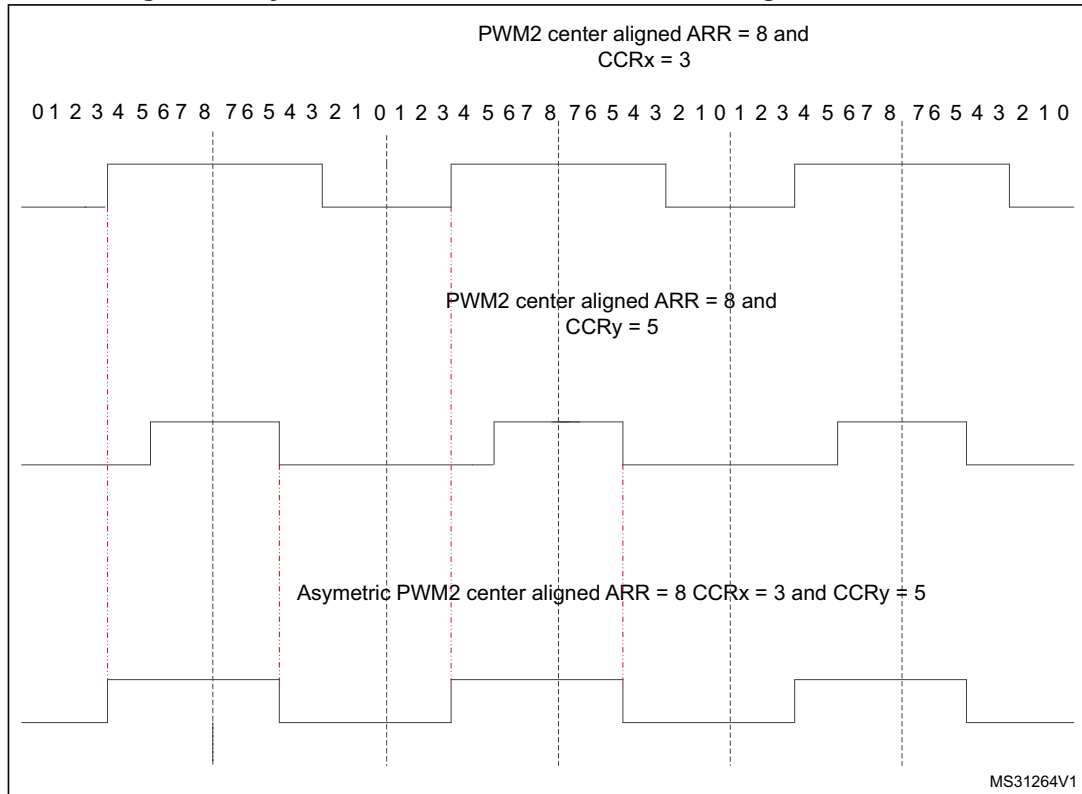

To configure the timer in this mode:

1. Configure the output pin:
 - a) Select the output mode by writing CCS bits in CCMRx register.
 - b) Select the polarity by writing the CCxP bit in CCER register.
2. Select the Asymmetric PWM mode (Asymmetric PWM1 or Asymmetric PWM2) by writing OCxM bits in CCMRx register.
3. Program the period, the pulse length and the phase shift respectively in ARR, CCRx and CCRy registers.
4. Select the counting mode: the Asymmetric PWM mode is working only with center aligned mode: the counter mode must be center aligned counting mode (CMS bits different from '00').
5. Enable the capture compare.
6. Enable the counter.

For more details on how to use the timer in this mode, refer to the examples provided in the STM32F30x standard peripheral libraries, in the /Project/STM32F30x_StdPeriph_Examples/ TIM/Asymmetric folders.

STM32Cube F3 firmware package includes examples in the following directories:

- Projects\STM32F3-Discovery\Examples\TIM\TIM_Asymetric,
- Projects\STM32303E_EVAL\Examples\TIM\TIM_Asymetric
- Projects\STM32303C_EVAL\Examples\TIM\TIM_Asymetric.

2.8 Timer combined PWM mode available for STM32F30x and STM32F3x8 lines

The combined mode allows generating edge or center aligned PWM signals with programmable delay and phase shift between respective pulses. To generate a combined signal, the TIMx_CCRx and TIMx_CCRy must be used to program the delay and the phase shift, the frequency is determined by the value of the TIMx_ARR register. The resulting signal (combined signal) is made of an OR or AND logical combination of two reference PWMs. So the combined PWM mode can be selected independently on two channels by programming the OCxM bits in TIMx_CCMRx register:

- OCxM = 1100 to use the Combined PWM1, in this case the combined output reference has the same behavior as in PWM mode 1. The combined output reference is the logical OR between OC1/3REF and OC2/4REF
- OCxM = 1101 to use the Combined PWM2, in this case the combined output reference has the same behavior as in PWM mode 2. The combined output reference is the logical AND between OC1/2REF and OC2/4REF

The following figures resume the combined mode

Figure 2. Combined PWM mode

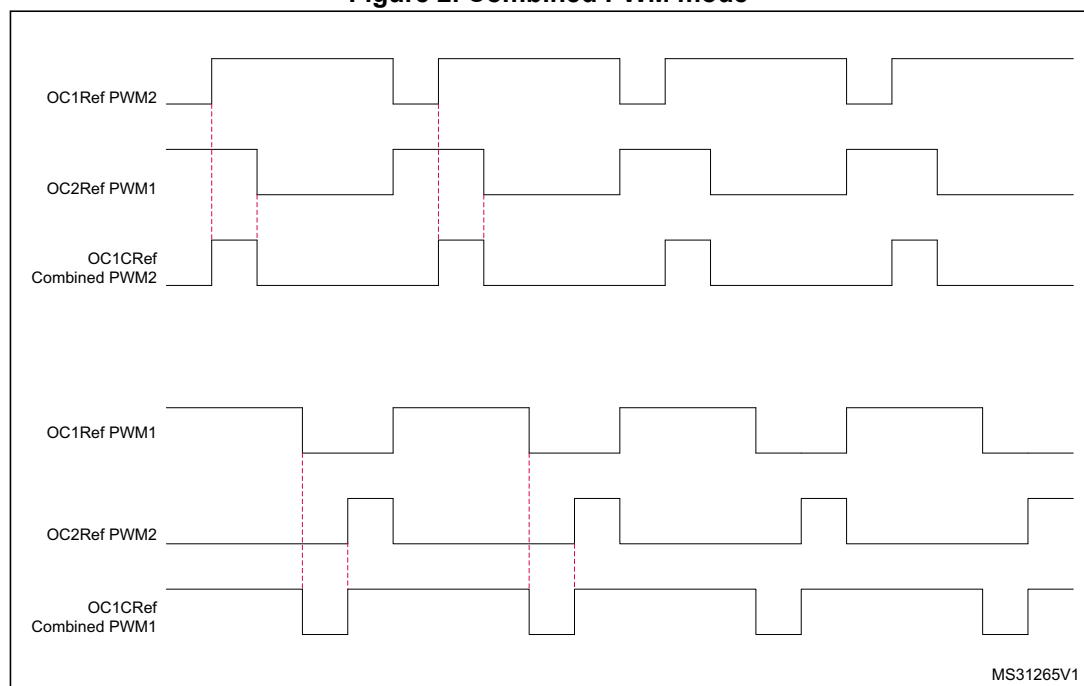

MS31265V1

To configure the timer in this mode:

1. Configure the output pin:
 - a) Select the output mode by writing CCS bits in CCMRx register.
 - b) Select the polarity by writing the CCxP bit in CCER register.
2. Select the Combined PWM mode (Combined PWM1 or Combined PWM2) by writing OCxM bits in CCMRx register.
3. Program the period, the delay and the phase shift respectively in ARR, CCRx and CCRy registers.
4. Select the counting mode:
 - a) Edge-aligned mode: the counter must be configured up-counting or down-counting.
 - b) Center aligned mode: the counter mode must be center aligned counting mode (CMS bits different from '00')
5. Enable the capture compare.
6. Enable the counter.

2.9 Retriggerable one pulse mode available for STM32F30x and STM32F3x8

The Retriggerable one pulse mode is a one pulse mode with the particularity of:

- The pulse starts as soon as the trigger occurs (no programmable delay)
- The pulse is extended if a new trigger occurs before the previous one is completed

If the counter is configured in up-counting mode, the corresponding CCRx must be set to 0, in this case the pulse length is determined by ARR register. If the timer is configured in down-counting mode, the ARR must be set to 0 in this case the pulse length is determined by CCRx register. As for the OPM mode, there are two Retriggerable one pulse mode, Retriggerable OPM mode 1 and Retriggerable OPM mode 2:

- Retriggerable OPM mode 1 is selected by setting the OCXM bits to 1000:
 - In up-counting mode, channel is inactive until a trigger event is detected (on TRGI signal), the comparison is performed like in PWM mode 1, then the channel becomes inactive again at the next update.
 - In down-counting mode, channel is active until a trigger event is detected (on TRGI signal), the comparison is performed like in PWM mode 1, then the channel becomes active again at the next update.
- Retriggerable OPM mode 2 is selected by setting the OCXM bits to 1001:
 - In up-counting mode, the channel is active until a trigger event is detected (on TRGI signal), the comparison is performed like in PWM mode 2, then the channel becomes inactive again at the next update.
 - In down-counting mode, the channel is inactive until a trigger event is detected (on TRGI signal), the comparison is performed like in PWM mode 1, then the channel becomes inactive again at the next update.

The following figure presents an example of the Retriggerable OPM mode

Figure 3. Retriggerable OPM mode

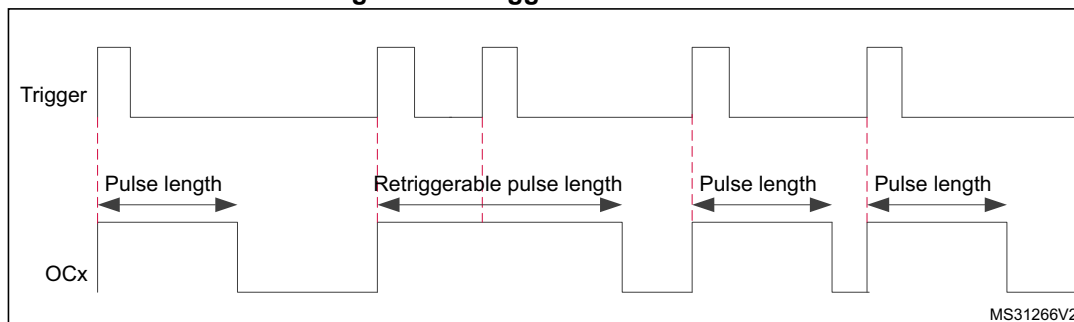

To configure the timer in this mode:

1. Configure the input pin and mode:
 - a) Select the TIxFPx trigger to be used by writing CCxS bits in CCMRx register.
 - b) Select the polarity of the input pin by writing CCxP and CCxNP bits in CCER register.
 - c) Configure the TIxFPx trigger for the slave mode trigger by writing TS bits in SMCR register.
 - d) Select the Combined Reset + trigger mode for the slave mode by writing SMS = 1000 in SMCR register.
2. Configure the output pin and mode:
 - a) Select the output polarity by writing CCyP bit in CCER register.
 - b) Select the output compare mode by writing OCyM bits in CCMRy register (Retriggerable OPM mode 1 or Retriggerable OPM mode 2).
 - c) Set the Pulse length value by writing in CCRy register if the counter is down-counting or by writing in the ARR if the counter is up-counting.

For more details on using the timer in this mode, refer to the examples provided in the STM32F30x standard peripheral libraries, in the /Project/STM32F30x_StdPeriph_Examples/ TIM/Retriggerable OPM folder.

3 Timer synchronization

3.1 Timer system link

STM32 timers are linked together internally for timer synchronization or chaining. Each timer has several internal trigger inputs and outputs. These signals allow the timer to be connected with other timers.

Figure 4. Timer system link

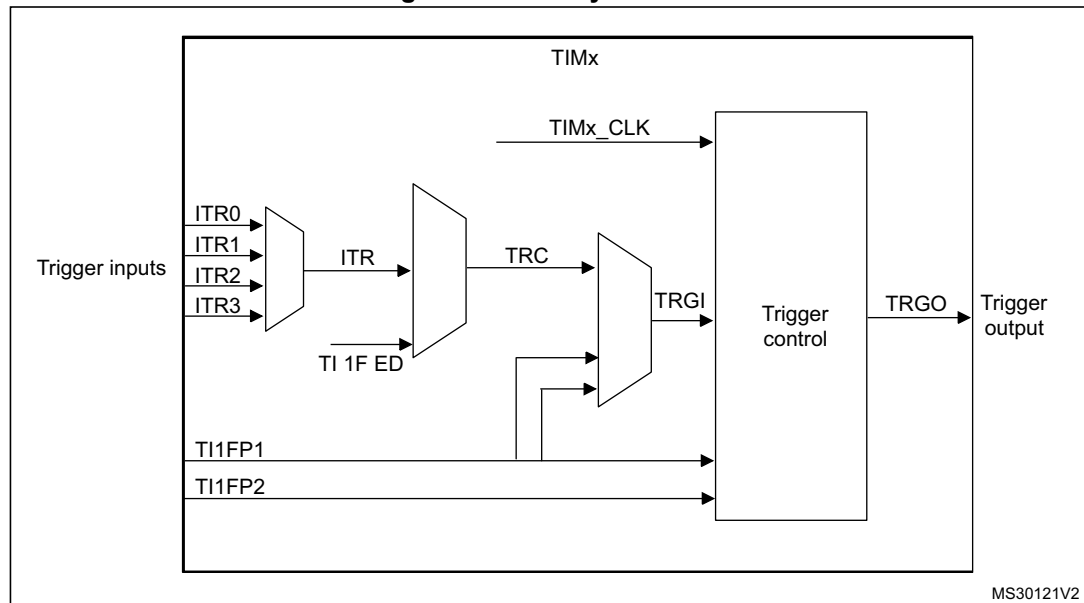

3.2 Master configuration

When a timer is selected as a master timer, the corresponding trigger output signal is used by the slave internal trigger (when configured). The trigger output can be selected from the following list:

- **Reset:** the UG bit from the EGR register is used as a trigger output (TRGO).
- **Enable:** the counter enable signal is used as a trigger output (TRGO). It is used to start several timers at the same time, or to control a window in which a slave timer is enabled.
- **Update:** the update event is selected as trigger output (TRGO). For example, a master timer can be used as a prescaler for a slave timer.
- **Compare pulse:** the trigger output sends a positive pulse when the CC1IF flag is to be set (even if it was already high) as soon as a capture or a compare match occurs.
- **OC1Ref:** OC1REF signal is used as trigger output (TRGO).
- **OC2Ref:** OC2REF signal is used as trigger output (TRGO).
- **OC3Ref:** OC3REF signal is used as trigger output (TRGO).
- **OC4Ref:** OC4REF signal is used as trigger output (TRGO).

To configure a timer in master mode:

1. Configure your timer.
2. Select the trigger output to be used, by writing the MSM (Master Mode Selection) bits in CR2 register.
3. Enable the MSM (Master/slave mode) bit in the SMCR register to allow a perfect synchronization between the current timer and its slaves (through TRGO).

For the STM32F30x and STM32F3x8 the timer can generate two trigger outputs TRGO as described below and TRGO2 (used for TIM and ADC synchronization) which can be selected from the following list:

- Reset - the UG bit from the EGR register is used as trigger output (TRGO2).
- Enable - the Counter Enable signal CNT_EN is used as trigger output (TRGO2). It is useful to start several timers at the same time or to control a window in which a slave timer is enable. The Counter Enable signal is generated by a logic OR between CEN control bit and the trigger input when configured in gated mode.
- Update - The update event is selected as trigger output (TRGO2). For instance a master timer can then be used as a prescaler for a slave timer.
- Compare Pulse - The trigger output send a positive pulse when the CC1IF flag is to be set (even if it was already high), as soon as a capture or a compare match occurred.
- Compare - OC1REF signal is used as trigger output (TRGO2)
- Compare - OC2REF signal is used as trigger output (TRGO2)
- Compare - OC3REF signal is used as trigger output (TRGO2)
- Compare - OC4REF signal is used as trigger output (TRGO2)
- Compare - OC5REF signal is used as trigger output (TRGO2)
- Compare - OC6REF signal is used as trigger output (TRGO2)
- Compare Pulse - OC4REF rising or falling edges generate pulses on TRGO2
- Compare Pulse - OC6REF rising or falling edges generate pulses on TRGO2
- Compare Pulse - OC4REF rising or OC6REF rising edges generate pulses on TRGO2
- Compare Pulse - OC4REF rising or OC6REF falling edges generate pulses on TRGO2
- Compare Pulse - OC5REF rising or OC6REF rising edges generate pulses on TRGO2
- Compare Pulse - OC5REF rising or OC6REF falling edges generate pulses on TRGO2

3.3 Slave configuration

The slave timer is connected to the master timer through the input trigger. Each ITRx is connected internally to another timer, and this connection is specific for each STM32 product.

The slave mode can be:

- **Reset mode:** rising edge of the selected trigger input (TRGI) reinitializes the counter and generates an update of the registers.
- **Gated mode:** the counter clock is enabled when the trigger input (TRGI) is high. The counter stops (but is not reset) as soon as the trigger becomes low. Both start and stop of the counter are controlled.
- **Trigger mode:** the counter starts at a rising edge of the trigger TRGI (but it is not reset). Only the start of the counter is controlled.
- **External clock mode 1:** rising edges of the selected trigger (TRGI) clock the counter.
- **Combined Reset + Trigger Mode** - Rising edge of the selected trigger input (TRGI) reinitializes the counter, generates an update of the registers and starts the counter. This mode is present only for STM32F30xC/Bx and STM32F358xC.

To configure a timer in slave mode:

1. Select the slave mode to be used by writing SMS (Slave Mode Selection) bits in SMCR register.
2. Select the internal trigger to be used by writing TS (Trigger selection) bits in SMCR register

For more details on using the timer in this mode, refer to the examples provided in the STM32xx standard peripheral libraries, in the /Project/STM32xx_StdPeriph_Examples/TIM/Cascade_Synchro, /ExtTrigger_Synchro and /Parallel_Synchro folders.

4 Advanced features for motor control

4.1 Signal generation

The STM32 timer can output two complementary signals and manage the switching-off and the switching-on instants of the outputs.

The complementary signals OCx and OCxN are activated by a combination of several control bits: the CCxE and CCxNE and the MOE, OISx, OISxN, OSSI and OSSR bits.

The main output enable (MOE) bit is reset as soon as a break input is active. It is set by software or automatically, depending on the automatic output enable (AOE) bit. When this bit (MOE) is reset, the OCx and OCxN outputs are disabled or forced to idle state (OISx OISxN), depending on whether the OSSI bit is set or not.

Note: The MOE bit is valid only on the channels that are configured in output.

The Off-state selection for Run mode (OSSR) bit is used when MOE=1 on channels that have a complementary output configured as outputs. When this bit is set, OCx and OCxN outputs are enabled with their inactive level as soon as CCxE=1 or CCxNE=1. The output is still controlled by the timer.

The Off-state selection for Idle mode (OSSI) bit is used when MOE=0 due to a break event or by a software write, on channels configured as outputs. When this bit is set, OCx and OCxN outputs are first forced with their inactive level, then forced to their idle level after the dead time. The timer maintains its control over the output.

[Table 4](#) explains the possible configurations of the advanced timer.

Table 4. Advanced timer configurations

Control bits					Output state		Typical use
MOE	OSSI	OSSR	OCxE	OCxNE	OCx output state	OCxN output state	
1	x	0	0	0	Output disable	Output disable	General purpose
	x	0	0	1	Output disable	OCxREF + Polarity	
	x	0	1	0	OCxREF + Polarity	Output disable	
	x	0	1	1	OCxREF + Polarity + Deadtime	(not OCxREF) + Polarity + Deadtime	Motor control (sinewave)
	x	1	0	0	Output disabled	Output disabled	Motor control (6-steps)
	x	1	0	1	Off-state	OCxREF + Polarity	
	x	1	1	0	OCxREF + Polarity	Off-state	
	x	1	1	1	OCxREF + Polarity + Deadtime	(not OCxREF) + Polarity + Deadtime	Motor control (sinewave)
MOE	OSSI	OSSR	OCxE	OCxNE	OCx output state	OCxN output state	Comments
0	0	x	0	0	Output disable		Outputs disconnected from I/O ports
	0	x	0	1			
	0	x	1	0			
	0	x	1	1			
	1	x	0	0	Off-state (outputs are first forced with their inactive level then forced to their idle level after the deadtime.)		All PWMs OFF (low Z for safe stop)
	1	x	0	1			
	1	x	1	0			
	1	x	1	1			

- Note:
- 1 Dead time insertion is enabled by setting both CCxE and CCxNE bits, and the MOE bit.
 - 2 When only OCxN is enabled (CCxE=0, CCxNE=1), it is not complemented and becomes active as soon as OCxREF is high. For example, if CCxNP=0 then OCxN=OCxRef. On the other hand, when both OCx and OCxN are enabled (CCxE=CCxNE=1) OCx becomes active when OCxREF is high, whereas OCxN is complemented and becomes active when OCxREF is low.

4.2 Combined three-phase PWM mode available for STM32F30x and STM32F3x8

The combined three-phase mode allows generating one to three center-aligned PWM signals with a single programmable signal ANDed in the middle of the pulses.

Using the 3-bits GC5C[3:1] in the TIMx_CCR5, each channel of the TIM can be a combination between the original signal and the OC5Ref signal:

- If GC5C1 is set, OC1 output is controlled by TIMx_CCR1 and TIMx_CCR5
- If GC5C2 is set, OC2 output is controlled by TIMx_CCR2 and TIMx_CCR5
- If GC5C3 is set, OC3 output is controlled by TIMx_CCR3 and TIMx_CCR5

The following figure presents an example of this mode

Figure 5. Combined three-phase PWM

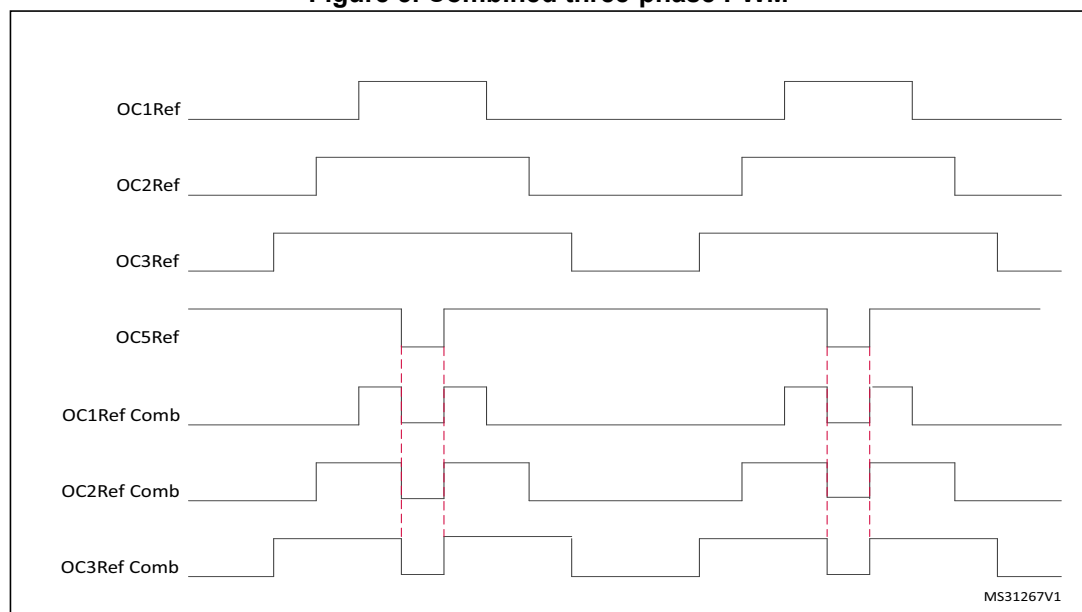

To configure the timer in this mode:

1. Configure the output pin:
 - a) Select the output mode by writing CCS bits in CCMRx register.
 - b) Select the polarity by writing the CCxP bit in CCER register.
2. Configure the used channel (1, 2 or/and 3) in PWM mode
 - a) configure the frequency, the duty cycle and the polarity.
 - b) Select the PWM 1 or 2.
3. Configure the Channel 5 in PWM mode with the desired parameter (duty cycle)
4. Select the Combined PWM mode by programming the GC5Cx bits.
5. Select the Center aligned mode as counting mode
6. Enable the capture compare.
7. Enable the counter.

For more details on using the timer in this mode, refer to the examples provided in the STM32F30x standard peripheral libraries, in the /Project/STM32F30x_StdPeriph_Examples/ TIM/Combined folders.

STM32Cube F3 firmware package includes examples in the following directories:

- Projects\STM32F3-Discovery\Examples\TIM\TIM_Combined,
- Projects\STM32303E_EVAL\Examples\TIM\TIM_Combined,
- Projects\STM32303C_EVAL\Examples\TIM\TIM_Combined.

4.3 Specific features for motor control applications

4.3.1 Complementary signal and dead time feature

STM32xx advanced timers can generate up to three complementary outputs with insertion of dead time.

To use the complementary signal for one channel, set the two output compare enable bits of this channel and its complementary (OCxE and OCxNE) channel. If the dead time bits are different from zero, the two signals are generated with insertion of a dead time as illustrated in *Figure 6: Two signals are generated with insertion of a dead time*:

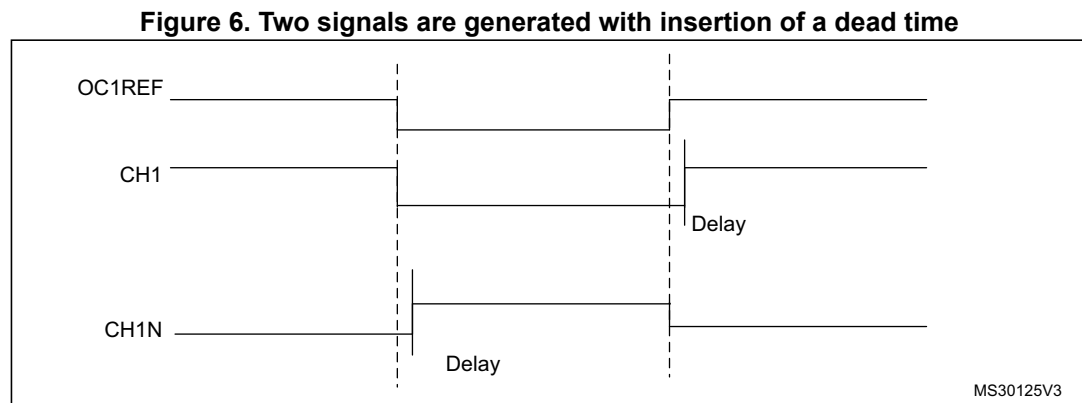

The dead time parameter is computed using the DTG[7:0] bits and the dead time clock (Tdtg).

The dead time clock is computed as follows:

$$\begin{aligned} Tdtg &= TDTS, & \text{if } DTG[7] &= 0 \\ Tdtg &= 2 \times TDTS, & \text{if } DTG[6] &= 0 \\ Tdtg &= 8 \times TDTS, & \text{if } DTG[5] &= 0 \\ Tdtg &= 16 \times TDTS, & \text{if } DTG[7:5] &= 111 \end{aligned}$$

Where: $TDTS = TCK_INT$, if $CKD[1:0] = 00$
 $TDTS = 2 \times TCK_INT$, if $CKD[1:0] = 01$
 $TDTS = 4 \times TCK_INT$, if $CKD[1:0] = 10$

Note: TCK_INT is the timer internal clock.

The dead time delay is computed using the following formula:

$$\text{Dead time} = \text{DTG}[7:0] \times \text{Tdtg}, \text{ if } \text{DTG}[7] = 0$$

$$\text{Dead time} = (64 + \text{DTG}[5:0]) \times \text{Tdtg}, \text{ if } \text{DTG}[6] = 0$$

$$\text{Dead time} = (32 + \text{DTG}[4:0]) \times \text{Tdtg}, \text{ if } \text{DTG}[5] = 0$$

$$\text{Dead time} = (32 + \text{DTG}[4:0]) \times \text{Tdtg}, \text{ if } \text{DTG}[7:5] = 111$$

For more details on using the timer in this mode, refer to the examples provided in the STM32xx standard peripheral libraries, in the /Project/STM32xx_StdPeriph_Examples/TIM/ComplementarySignals folder.

STM32Cube F3 firmware includes package examples in the following directories:

- Projects\STM32F3-Discovery\Examples\TIM\TIM_ComplementarySignals,
- Projects\STM32373C_EVAL\Examples\TIM\TIM_ComplementarySignals,
- Projects\STM32303E_EVAL\Examples\TIM\TIM_ComplementarySignals,
- Projects\STM32303C_EVAL\Examples\TIM\TIM_Combined.

Note: This example is not available for STM32L1 series.

4.3.2 Break input

The break input is an emergency input in the motor control application. The break function protects power switches driven by PWM signals generated with the advanced timers. The break input is usually connected to fault outputs of power stages and 3-phase inverters. When activated, the break circuitry shuts down the TIM outputs and forces them to a predefined safe state.

The break event is generated by:

- The BRK input that has a programmable polarity and an enable bit BKE.
- The CSS (Clock Security System).
- Software, by setting the BG bit in the EGR register.

When a break event occurs:

- The MOE bit (main output enable) is cleared.
- The break status flag is set and an interrupt request can be generated.
- Each output channel is driven with the level programmed in the OISx bit.

Break inputs in STM32F30x and STM32F3x8

In these lines there are two break inputs Break1 and Break2. The break can be generated by any of the two BRK inputs which have:

- a programmable polarity (BKPx bit in the TIMx_BDTR Register)
- a programmable enable bit (BKEx in the TIMx_BDTR Register)
- a programmable filter (BKxF[3:0] bits in the TIMx_BDTR Register) to avoid spurious events.

The following table presents the priorities between the two break inputs.

Table 5. Behavior of timer outputs versus Break1 and Break2 inputs

Break input 1	Break input 2	OCxN output	OCx output
Active	Inactive	ON after deadtime insertion	OFF
Inactive	Active	OFF	OFF
Active	-	ON after deadtime insertion	OFF

4.3.3 Locking mechanism

The advanced timers registers and bits can be protected or locked in order to safeguard the application using the locking mechanism by programming the LOCK bits in the BDTR register. There are three locking levels.

Table 6. Locking levels

Level 1		LOCK Level 2 ⁽¹⁾		LOCK Level 3 ⁽²⁾	
Register	Bits	Register	Bits	Register	Bits
CR2	OISx	CR2	OISx	CR2	OISx
	OISxN		OISxN		OISxN
BDTR	DTG[7:0]	BDTR	DTG[7:0]	BDTR	DTG[7:0]
	BKE		BKE		BKE
	BKP		BKP		BKP
	AOE		AOE		AOE
-	BK2E ⁽³⁾	-	OSSR	-	OSSR
-	BK2P ⁽³⁾	-	OSSI	-	OSSI
-	BKF[3:0] ⁽³⁾	CCER	CCxP	CCER	CCxP
-	BK2F[3:0] ⁽³⁾		CCxNP		CCxNP
-	-	-	-	CCMRx	OCxM
-	-	-	-		OCxPE

1. LOCK Level 2 = LOCK Level 1 + CC polarity bits (CCxP/CCxNP bits in TIMx_CCER)

2. LOCK Level 3 = LOCK Level 2 + CC control bits (OCxM and OCxPE)

3. Bits present in STM32F30x and STM32F3x8 products lines.

Note: The LOCK bits can be written only once after the reset. Once the BDTR register has been written, its content is frozen until the next reset.

4.3.4 Specific features for feedback measurement

Encoder modes

The incremental encoder is a type of sensor used in motor-control applications to measure the angular position.

In general, the incremental encoder generates three signals: phase A, phase B and index.

The direction of the motor depends if Phase A leads Phase B, or Phase B leads Phase A. A third channel, Index pulse, occurs once per revolution and is used as a reference to measure an absolute position.

The Phase A and B output signals are connected to the encoder interface to compute the frequency and then deduce the velocity and the position. Velocity and position information can be measured at X2 or X4 resolution. The following figures explain the encoder interface function.

The timer's counter is incremented or decremented for each transition on both inputs T11 and T12.

Figure 7. Position at X4 resolution

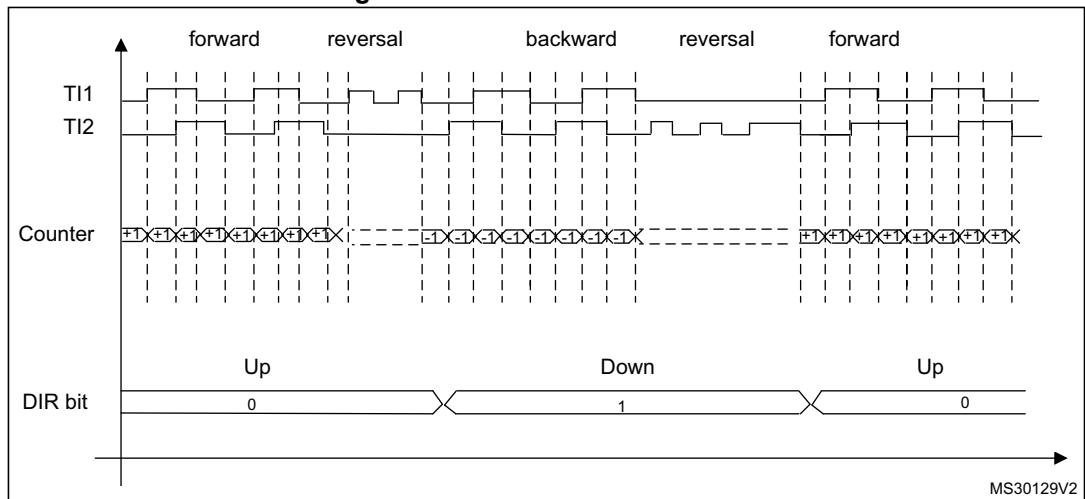

The timer's counter is incremented or decremented for each transition on the selected input T11 or T12.

Figure 8. Position at X2 resolution

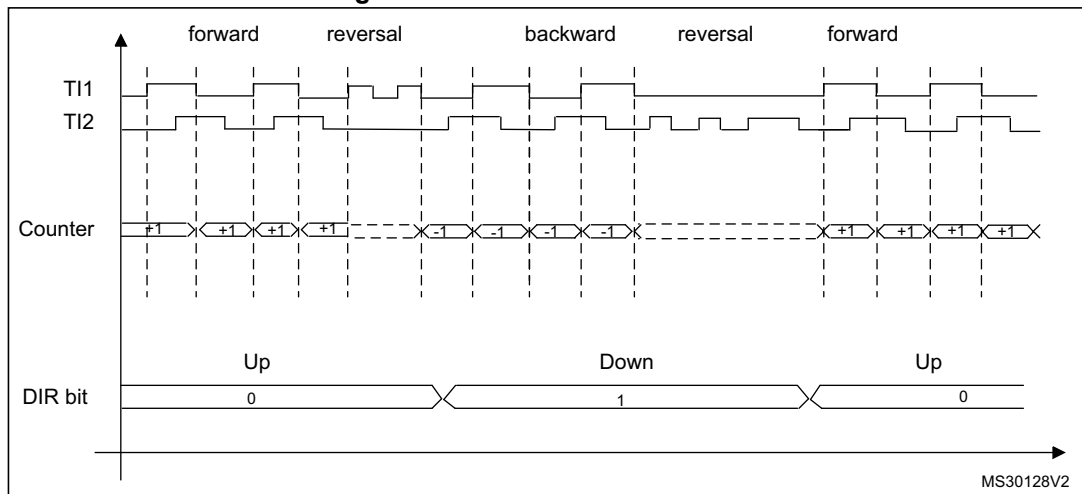

Note: The counter in case of resolution X2 can also be incremented on the TI1 edge.

In STM32 timer encoder interface mode, the encoder mode3 corresponds to resolution X4. In this mode, the counter counts up/down on both TI1 and TI2 edges.

The resolution X2 is selected when encoder mode 1 or mode 2 is selected, that is, the counter counts up/down on TI2 edge depending on the TI1 level, or the counter counts up/down on TI1 edge depending on TI2 level.

How to use the encoder interface

An external incremental encoder can be connected directly to the MCU without external interface logic. The third encoder output (index) which indicates the mechanical zero position, may be connected to an external interrupt input and trigger a counter reset.

The output signal of the incremental encoder is filtered by the STM32 timer input filter block to reject all noise sources that typically occur in motor systems. This filter is used as described in [Section 2.3: Timer input capture mode](#).

TIM configuration in encoder mode

1. Select and configure the timer input:
 - Input selection:
 - TI1 connected to TI1FP1 CC1S='01' in CCMR1 register
 - TI2 connected to TI2FP2 CC2S='01' in CCMR1 register
 - Input polarity:
 - CC1P='0' and CC1NP='0'(CCER register, TI1FP1 non-inverted, TI1FP1=TI1).
 - CC2P='0' and CC2NP='0'(CCER register, TI1FP2 non-inverted, TI1FP2= TI2).
2. Select the encoder mode
 - Encoder mode1 (resolution X2 on TI2): SMS='001' in SMCR register.
 - Encoder mode2 (resolution X2 on TI1): SMS='010' in SMCR register.
 - Encoder mode3 (resolution X4 on TI1 and TI2): SMS='011' in SMCR register.
3. Enable the timer counter
 - Set the counter enable bit, CEN='1' in CR1 register.

Hall sensor

The Hall sensor is a type of sensor based on Hall effect: when a conductor is placed in a magnetic field, a voltage will be generated perpendicular to both the current and the magnetic field.

There are four types of Hall sensor IC devices that provide a digital output: unipolar switches, bipolar switches, omni polar switches, and latches. The main difference between them is the output waveforms (pulse duration).

The digital Hall sensor provides a digital output in relation to the magnetic field to which it is exposed. When the magnetic field increases and is greater than the BRP (magnetic field release point value), the output will be ON. When the magnetic field decreases and is lower than the BOP (magnetic field operate point value) the output will be OFF.

Figure 9 presents the output waveform of a typical Hall sensor.

Figure 9. Output waveform of a typical Hall sensor

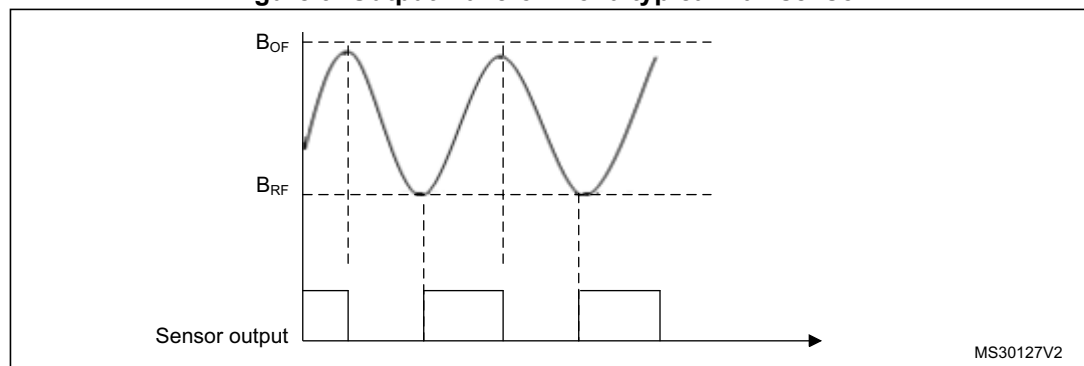

Generally, the Hall sensor is used in the three-phase motor control. Figure 10: Commutation sequence presents the commutation sequence.

Figure 10. Commutation sequence

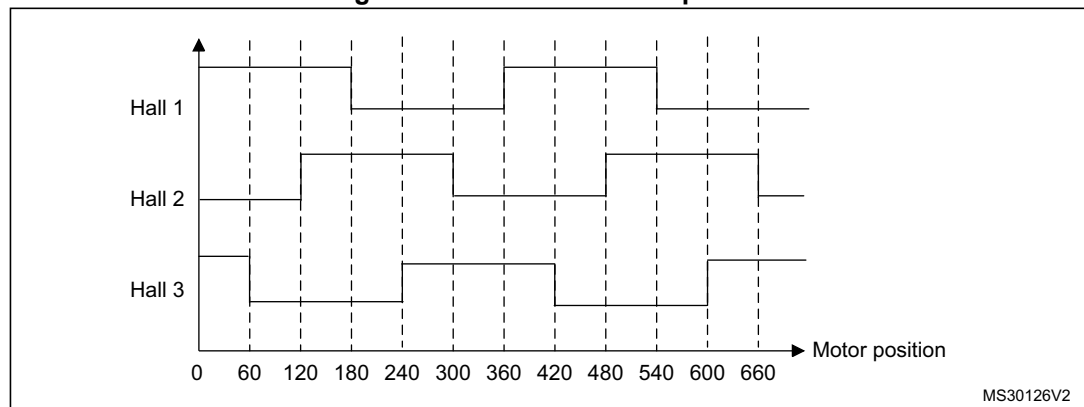

How to use the Hall sensor interface

The STM32 timers can interface with the Hall effect sensors via the standard inputs (CH1, CH2 and CH3). Setting TI1S bit in the CR2 register, allows the input filter of channel 1 to be connected to the output of a XOR gate, combining the three input pins TIMx_CH1, TIMx_CH2 and TIMx_CH3.

The slave mode controller is configured in reset mode; the slave input is TI1F_ED. Thus, each time one of the 3 inputs toggles, the counter restarts counting from 0. This creates a time base triggered by any change on the Hall inputs.

Channel 1 is configured in input capture mode, capture signal is TRC. The captured value, which corresponds to the time, elapsed between 2 changes on the inputs, gives information about motor speed.

TIM configuration in Hall sensor interface mode

1. Configure 3 timer inputs ORed to the TI1 input channel by writing the TI1S bit in CR2 register to '1',
2. Program the time base: write the ARR to the max value (the counter must be cleared by the TI1 change. Set the prescaler to get a maximum counter period longer than the time between 2 changes on the sensors,
3. Program channel 1 in capture mode (TRC selected): write the CC1S bits in the CCMR1 register to '01'. You can also program the digital filter if needed.

5 Specific applications

5.1 Infrared application

The STM32 general-purpose timers can be used to emulate several infrared protocol. An example of this application is explained in application note AN3174 "Implementing an RC5 infrared remote control receiver with the STM32F100/101/102/103/105/107 microcontrollers lines.

This application note describes a software solution for implementing an RC5 receiver using the STM32 general-purpose timers.

5.2 3-phase AC and PMSM control motor

The STM32 advanced and general-purpose timers with ADC and DAC are used to control two types of 3-phase motor: AC induction motor and PMSM, with different current sensing methodologies:

- Isolated current sensing
- Three shunt resistors
- Single shunt resistor (ST patented solution)

The STM32 timers are used also in the feedback loop to interface with the different sensors used in the different rotor position feedback:

- Tachogenerator
- Quadrature encoder
- Hall sensors: 60° and 120° placement

For more details, please refer to: `stm32_pmsm_foc_motorcontrol_fmlib`.

5.3 Six-step mode

The six step mode is a specific mode of STM32 advanced timers. When complementary outputs are used on a channel, preload bits are available on the OCxM, CCxE and CCxNE bits. The preload bits are transferred to the shadow bits at the COM (commutation event). Thus you can program in advance the configuration for the next step and change the configuration of all the channels at the same time. COM can be generated by software by setting the COM bit in the EGR register or by hardware (on TRGI rising edge).

An application example of the use of this mode is the control of the brush-less 3-phase DC motor (3-phase BLDC motor).

Configuring the timer to generate a six step signal to control a brush-less 3-phase DC motor (3-phase BLDC motor):

- Time base configuration: prescaler, period, clock source
- Channels 1, 2, 3 and 4 configured in PWM mode
- Set the capture compare preload control bit CCPC
- Enable the commutation interrupt source
- Use the system tick to generate time base
- Each commutation event, the TIM configuration is updated for the next commutation event.

For more details on using the timer in this mode, refer to the examples provided in the STM32xx standard peripheral libraries, in the /Project/STM32xx_StdPeriph_Examples/TIM/6Steps folder.

Note: This example is not available for STM32L1 series.

6 Revision history

Table 7. Document revision history

Date	Revision	Changes
21-Feb-2012	1	Initial release.
22-Oct-2012	2	Added support for STM32F30x, STM32F31x, STM32F37x, STM32F38x.
12-Feb-2014	3	Added support for STM32F0 series, STM32F358xC. Replaced “basic timers” by “general-purpose” timers in the whole document. Updated <i>Section 2.1.2: External clock</i> . Updated <i>Section 2.4: Timer output compare mode</i> . Updated <i>Section 2.5: Timer PWM mode</i> . Updated <i>Section 5.3: Six-step mode</i> .
28-Jan-2015	4	Extended the applicability to STM32F303xDxE. Updated: <ul style="list-style-type: none"> – <i>Table 1: Applicable products</i> – <i>Table 2: STM32 family timers</i> – The document title and introduction Added references to timer examples available in STM32Cube F3 firmware package where applicable.

IMPORTANT NOTICE – PLEASE READ CAREFULLY

STMicroelectronics NV and its subsidiaries (“ST”) reserve the right to make changes, corrections, enhancements, modifications, and improvements to ST products and/or to this document at any time without notice. Purchasers should obtain the latest relevant information on ST products before placing orders. ST products are sold pursuant to ST’s terms and conditions of sale in place at the time of order acknowledgement.

Purchasers are solely responsible for the choice, selection, and use of ST products and ST assumes no liability for application assistance or the design of Purchasers’ products.

No license, express or implied, to any intellectual property right is granted by ST herein.

Resale of ST products with provisions different from the information set forth herein shall void any warranty granted by ST for such product.

ST and the ST logo are trademarks of ST. All other product or service names are the property of their respective owners.

Information in this document supersedes and replaces information previously supplied in any prior versions of this document.

© 2015 STMicroelectronics – All rights reserved