PICmicro™ Microcontroller Oscillator Design Guide

<i>Author:</i> <i>Kim Peck</i> <i>Consultant</i>

Designing a clock oscillator without some knowledge of the fundamental principals of acoustic resonators is possible but fraught with the uncertainty of "cut and try" methods. While the oscillator may be made to run with the chosen resonator, it is quite likely that the unit will be slightly off the intended frequency, be grossly off frequency because it is operating on an unintended mode, or have unacceptable temperature characteristics because the wrong resonator was chosen for the application.

This application note is primarily for informational purposes. It is intended to help the designer of clock oscillators understand the parameters of crystal resonators and the terminology of the crystal resonator industry, both of which tend to be somewhat mysterious and arcane to the uninitiated. Details of crystal cuts and rotations, for instance, are of no use to the oscillator designer, only the designer of crystals. The oscillator designer still needs to understand and be able to predict the performance and trade-offs associated with these parameters. This is not an in-depth or rigorous treatment of acoustic resonators, but a practical guide, which should allow the designer to gain a basic understanding, and to help in choosing and specifying resonators.

INTRODUCTION

The main purpose of the oscillator in PICmicro microcontrollers, or almost any other microcontroller, is to provide a reliable clock for the controller processes. At the most basic level, the clock provides a timing interval to account for circuit rise times and to allow data to stabilize before that data is processed. This is a "synchronous" process. The clock also provides an opportunity for the programmer to perform time keeping of several types. In the PICmicro, the clock also drives hardware dedicated to timekeeping. The applications may include keeping "real time", or timing sensitive processes such as serial data communication. The accuracy of these timing applications is dependent upon the accuracy of the clock oscillator.

Design Challenges

The PICmicro microcontrollers offer unique design challenges because they are uniquely flexible. Flexibility usually demands difficult decisions on the part of the designer, but offers otherwise unattainable performance. The multiple oscillator options and wide range of operating voltages require awareness of advantages and trade-offs of various configurations. The PICmicro designer must be able to accurately predict stability performance of various configuration and then obtain that performance from the PICmicro clock in order to successfully implement these functions.

Wide Voltage Range

The PICmicro operates over such a wide voltage range that the oscillator parameters may be the limiting factor in the operation of the controller. If low power operation at low voltages is desired, the loop gain must be raised in order to insure reliable clock operation. If a nominal supply voltage is available, the loop gain must be reduced in order to prevent excessive power dissipation in the crystal. If battery operation is intended, then a careful balance must be struck between reliable operation at the low voltage, and damaging delicate resonators, or spurious oscillations at the high voltage when the battery is fresh.

Low Power

The outstanding performance of the Low Power option places a burden on the designer who would take advantage of this feature. The frequency chosen must be the lowest practical. Attention must be paid to the reactances associated with the crystal so as not to excessively load the oscillator output and cause excessive power consumption.

Low Cost

The low cost of the PICmicro series presents a challenge in finding commensurately low-cost components to complete the design. The relationship between cost and performance when various types of resonators are considered, is far from linear. The low cost of PICmicro microcontrollers, may remove them from the position of being the cost driver in some designs, challenging the designer to aggressively seek cost reductions in components which were previously not considered. The second challenge offered by such economical parts is that of new applications which were not considered practical before the advent of PICmicro processors.

THEORY OF OSCILLATORS

Conditions necessary for oscillation

An oscillator is a device which operates in a closed loop. This condition can be difficult to analyze, but the techniques for analysis are as valid for motor speed controls as it is for phase lock loops and oscillators. Oscillators are somewhat unique in that they are intentionally unstable, but in a controlled manner. In order for oscillation to occur in any feedback system, two primary requirements must be met. The total phase shift must be zero or 360° at the desired frequency and the system gain must be unity or greater at that frequency.

The Ideal Oscillator

The ideal oscillator has a perfectly flat temperature coefficient, is 100% power efficient, has no limits on operating frequency, has no spurious modes, has a perfect output wave shape, and is available in the high degrees of miniaturization which exists in semiconductors. This oscillator of course, does not exist. The primary limiting factor for most oscillator parameters is the resonator. The following is a discussion of the trade-off, potential advantages and primary disadvantages of several popular types of resonators, and how they will behave in a PICmicro oscillator design.

RESONATOR BASICS

There are several types of resonators available to the designer of microprocessor clocks. They all provide trade-offs between performance, size, frequency range and cost. Resonators for clock oscillators usually fall into two basic groups. These are quartz and ceramic resonators. Historically, ceramic resonators came into use in oscillators much later than quartz crystals and derive all of their terminology and conventions from the longer history of quartz crystals. A third type of clock oscillator is the RC (resistor / capacitor). This oscillator is a relaxation type, and employs no resonator as such. While this type requires the same basic conditions for oscillation to occur it is better described using different techniques and analogies.

Quartz Resonators

Quartz is the crystalline form of silicon dioxide. This same material, in amorphous form, is commonly found as beach sand and window glass. As a crystal, it exhibits piezoelectric effects as well as desirable mechanical characteristics. A quartz crystal resonator is an acoustical device which operates into the hundreds of MHz. Its resonance and high Q are mechanical in nature, and its piezoelectric effects create an alternating electrical potential which mirrors that of the mechanical vibration. Although it is one of the most common of naturally occurring crystals, natural quartz of sufficient size and purity to be used in the manufacturing suitable resonators, is unusual and expensive. Almost all modern resonators are manufactured using cultured quartz, grown in large autoclaves at high temperatures and pressures.

Whether naturally occurring or cultured, quartz crystals occur as six-sided prisms with pyramids at each end. This raw crystal is called a "boule". In an arbitrary coordinate system the Z, or optical axis, runs the length of the crystal, connecting the points of the pyramids at each end. If one views this hexagonal bar on end, three lines may be drawn between each of the six opposing corners. These are called X axes. Perpendicular to each X axis is a Y axis, which connects opposite pairs of faces. When the boule is cut into thin plates or bars called blanks, the cut of the saw is carefully oriented either along, or rotated relative to one of these axes. Orientation of the saw is chosen based on the mode of vibration for which the plate is intended, and the desired temperature profile. Plates are usually rounded into discs. Types of crystal cuts are named for the axis which the cutting angle is referenced when the blanks are cut from the boule. After being cut and rounded, the blanks are lapped to frequency and any surface finishing or polishing is done at this time. Electrodes are deposited on the blanks by evaporation plating, and the blank is mounted in the lower half of the holder. It is finished to the final frequency by fine adjustments in the mass of the electrode plating, either by evaporation or electroplating. The top cover is then hermetically sealed by one of several methods, which include cold welding and solder sealing.

Most crystals made today are A-T cut, which employ a thickness mode. This mode provides the highest frequency for a given thickness of the plate, and the best possible frequency stability over most temperature ranges. Many other modes of vibration are possible. Flexure modes are usually bar shaped, and are used for low frequency (near 100 kHz) resonators. Tuning fork crystals are a special case of this type.

Ceramic Resonators

Unlike quartz resonators, which are cut from a single crystal, a ceramic resonator is molded to a desired shape instead of grown. The material is polycrystalline form of barium titanate, or some similar material. The electrical model is almost identical, with the addition of one resistor, as the material is intrinsically conductive. The material is artificially made to exhibit piezoelectrically active by allowing it to cool very slowly, as in growing a quartz crystal (not nearly as long a time), but in the presence of a strong electric field. The molecular electric dipoles align themselves with the applied electric field. When the material has cooled, the alignment of the electric dipoles is retained, which is equivalent to piezoelectricity.

These materials have elastic properties that are not as desirable as quartz, and so their performance is not equal to that of quartz resonators. Specifically, ceramic resonators have far lower Qs and frequency deviations due to temperature on the order of 1000 to 10000 times greater than that of an A-T cut quartz crystal. The cost of ceramic resonators is much lower however, because the material is not grown under the extreme and expensive conditions that are necessary for quartz. They are also much smaller than A-T cut quartz resonators, particularly at frequencies under 2 MHz.

FIGURE 6: RESONATOR EQUIVALENT ELECTRICAL CIRCUIT

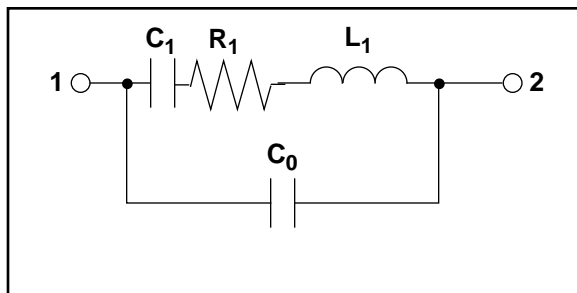
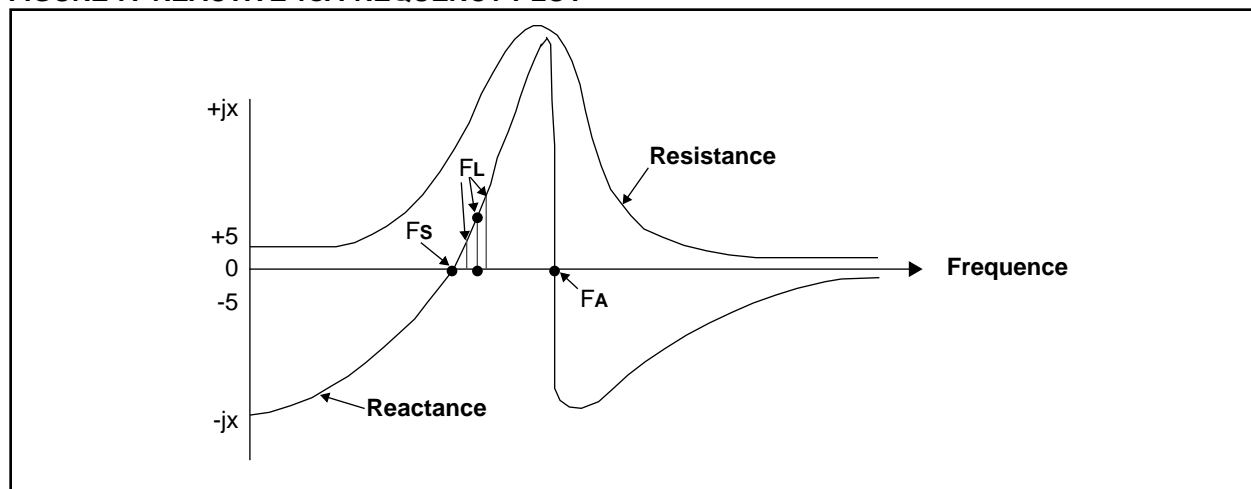

FIGURE 7: REACTIVE vs. FREQUENCY PLOT



Since the “Q” of ceramic resonators is generally lower than quartz, they are more easily pulled off frequency by variations in circuit or parasitic reactances. This is desirable if a circuit is designed with a variable element, as greater tuning range is realized. It is not desirable if the highest possible stability is the design goal, because the resonator will be more susceptible to variation in parasitic reactances, such as capacitors formed by circuit board etch, and temperature variations of intended circuit reactances. These variances will add to the already substantial deviation over temperature of the resonator itself. If your stability needs are modest however, ceramic resonators do provide a good cost / performance trade-off.

Equivalent electrical circuit

The circuit shown in Figure 6 is a close approximation of a quartz or ceramic resonator. It is valid for frequencies of interest to the PICmicro designer. Not all of the parasitic elements are shown as they are not important to this discussion. In this circuit, L_1 and C_1 are the reactances which primarily determine the resonator frequency, while a series resistor represents circuit losses. A shunt capacitor, C_0 represents the holder and electrode capacitance.

Because L_1 and C_1 are associated with mechanical vibration of the crystal, these are commonly referred to as motional parameters, while C_0 is called the static capacitance. The reactance of L_1 and C_1 are equal and opposite at the series resonant frequency, and their magnitude is very large as compared to R_1 . The phase shift at the series resonant frequency is zero, because the reactances cancel. The series resonant frequency is calculated as shown in Equation 1.

EQUATION 1: SERIES RESONANT FREQUENCY

$$F_s = \frac{1}{2\pi\sqrt{L_1 C_1}}$$

The actual series resonant frequency as determined by the zero phase point is slightly lower than this calculation because of the effects of C_0 , and for practical purposes can be considered identical. This fact may be useful to those designing tunable crystal oscillators. These resonator parameters are generally considered to be constant in the region of the main resonance, with the exception of R_1 . A plot of reactance over frequency is shown in Figure 7. The point labeled F_S is the series frequency, while F_L is the frequency where the crystal is resonant with an external load capacitor. Operation at this point is sometimes called parallel resonance. F_A is the frequency where the crystal is anti-resonant with its own electrode capacitance. Only the region below F_A is useful as an oscillator. Notice that the resistive component begins to rise, before F_S and continues steeply above F_S . This makes operation with small load capacitors (large reactances) difficult. One must be sure that if the resonator is specified to operate at a load capacity that the maximum value of R_1 is specified at that operating point. The zero phase shift point is the most common method of identifying the exact series resonant frequency. When the series frequency is known, operation at a load reactance is easily calculated as follows:

EQUATION 2: OPERATION AT A LOAD REACTANCE

$$\frac{\Delta F}{F_S} = \frac{C_1}{2(C_0 + C_L)}$$

where ΔF is the deviation from F_S to F_L , F_L is the operating frequency when in series with a load capacitor, F_S is the series resonant frequency (without any load capacitor), and C_L is the load capacitor.

The value of R_1 at the frequency F_L can be approximated by:

EQUATION 3: VALUE OF R_1 AT THE FREQUENCY F_L

$$R_1 = R_L \left(\frac{C_L}{C_0 + C_L} \right)^2$$

The reactance slope in the region of the series resonance can be approximated by:

EQUATION 4: REACTANCE SLOPE IN REGION OF SERIES RESONANCE

$$\frac{\Delta X}{\left(\frac{\Delta F}{F}\right)} \approx \frac{10^6}{\pi F C_1}$$

where ΔX is the reactance difference, in Ω , from series, at which of course the reactance is zero. $\Delta F/F$ is the fractional frequency deviation from series resonance. F is the frequency of interest in MHz, and C_1 is the crystal static capacitance of Figure 6. This is only accurate in the region of series resonance and the accuracy declines as frequencies further away from series are considered. This parameter is useful in determining the optimum C_1 , which the designer might specify in order to have the correct tuning sensitivity for any frequency adjustments, or given a crystal C_1 , what tuning sensitivity will result from various reactive components.

The ratio of the reactance of L_1 or C_1 to R_1 is arbitrarily designated as Q. This is also known as quality factor, and applies to any reactive component. The series resonant frequency of the crystal is the sum of the total series reactances. Quartz A-T cut crystals exhibit spurious modes which are always found at frequencies just above the main response. These are always present and are not associated with activity dips. There are also odd ordered mechanical overtone modes. Any of these modes (spurious or overtone) can be modeled as duplicates of the primary RLC electrical model, and placed in parallel with it (Figure 8). Notice however, that there is only one C_0 . Near the resonance of each series circuit, the effects of the other resonances may be considered negligible. Each resonance of course, has its own motional properties, the one of primary interest here is the R_1 of each resonance. The R_1 usually increases with increasing overtones, making higher overtones more lossy. The PICmicro designer must take care to specify the crystal spurious to always be of higher resistance than the desired response. This can be achieved in a well designed resonator. A heavy metal such as gold, as an electrode, will discourage higher overtones, by virtue of its higher mass. Crystals designed for high frequencies, almost always use a lighter material, such as aluminum. Electrode size also plays an important role.

FIGURE 8: EQUIVALENT CIRCUIT FOR SPURIOUS AND OVERTONE MODES

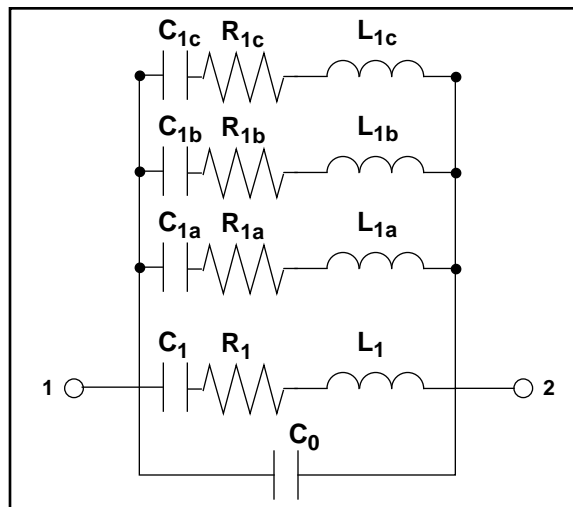

OSCILLATORS

Phase and Gain

As stated earlier, two conditions must be met for oscillation to occur. The phase shift must be zero or 360° at the desired frequency, and the total system gain must be one greater or at that frequency. Logic gates or inverters are convenient for this purpose. They have large amounts of gain, limit cleanly, produce square waves, and their output is appropriate for directly driving their respective logic families. Most oscillators in this family use an inverting amplifier, as shown in Figure 13. The phase shift is 180° through the gate, and the two reactances at either end of the crystal are chosen to provide an additional 90° each, bringing the total to the required 360°. The primary effect of changes in phase is to shift the operating frequency (to tune the crystal). The primary effect of changes in gain is to cause the oscillator to cease functioning when reduced, or cause spurious modes and excess power to be dissipated in the crystal when increased.

Oscillation will occur at the frequency for which the total phase shift is 360°. This is true for any frequency (or resonator response) for which the gain is greater than unity (including unwanted responses). The series resistor (R_S) is used to adjust the loop gain, and to provide some isolation from reactive loads for the amplifier. The lower limit of loop gain is determined primarily by the need for sufficient excess gain to account for all variations, such as those caused by temperature and voltage (not just in the amplifier, the crystal resistance may change as a function of temperature). The upper limit of loop gain should be that where it becomes possible (or at least likely) for the oscillator to operate on a spurious mode. In some resonators damage to the resonator is the overriding concern regarding drive level. If the stability requirement is rather "loose" the stability problems may not be the first indications of trouble. Excessive drive levels in tuning fork types for instance, may cause damage to the point that the crystal unit fails. It is important to estimate drive levels before operation begins, include and adjust a series resistance appropriately, and by measurement, verify the results.

Estimating Drive Levels

The drive levels may be estimated with the following steps. First find load impedance presented by crystal network, including phase shift capacitors and amplifier input impedance. This is found by the following:

EQUATION 5: LOAD IMPEDANCE

$$R_n \cong \frac{X_c^2}{R_S + R_{OSC1}}$$

where R_N is the network impedance. X_C is the reactance of one phase shift capacitor (assuming they are the same). R_{OSC1} is the input impedance of the OSC1 pin (should include reactance). R_S is reactance + resistance at operating frequency ($R_S + X_S$).

The current delivered into this impedance is found by:

EQUATION 6: CURRENT DELIVERED

$$I_n \cong \frac{V_{OUT}}{R_S + R_N}$$

where I_N is the RMS current drawn by the network. V_{OUT} is the OSC2 output RMS voltage. R_N is calculated above. R_S is described above. The current which passes through the crystal then is found by:

EQUATION 7: CURRENT THROUGH CRYSTAL

$$I_S \cong \frac{V_C}{R_S + R_{OSC1}}$$

The power dissipated by the crystal is then found by I_S squared times the crystal R_f .

Controlling Drive Levels

When designing any oscillator, one should take care not to lower the loaded Q of the resonator by inserting any resistive components between the phase shift capacitors (or any other reactive components) and the crystal. If it is necessary to reduce the drive level to the crystal, or lower overall loop gain, resistance should be inserted between the amplifier output, and the crystal (Figure 9). This method is much better than changing load reactances, which will have no significant effect on gain until the frequency has been pulled well away from the design center. This will also have the more significant effect of raising operating current, because if no series resistor is present, larger reactance of the phase shift capacitor will load the OSC2 output directly. If a very low drive level is required, such as with tuning fork type crystals, the series resistor is the best method. The resistor should be adjusted until the unit just runs with a typical crystal at the lowest operating voltage, and resulting drive measured at the highest operating voltage. The actual resistor value is best determined experimentally with a representative sample of crystals, and a broad range of values should be satisfactory. In general, the point where oscillation stops for any crystal unit (within specified parameters), is the resistor's upper limit. The lower limit may be 0 Ω , for a less fragile crystal type, depending on the operating frequency. If no spurious or overtone modes are encountered, it is likely that the oscillator may have relatively little excess

gain at that operating frequency. If resulting drive level at higher voltage is still unacceptable, then supply voltage variations must be reduced.

FIGURE 9: PICMICRO OSCILLATOR CIRCUIT

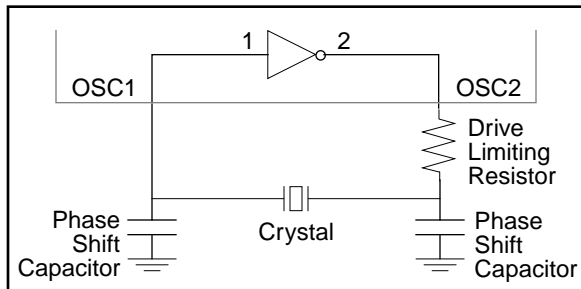

Measuring Drive Levels

Drive levels cannot be easily measured with any certainty by reading voltages at each end of the crystal. This is because of the phase shift which is present in varying degrees, depending on how close to series resonance of the crystal, the oscillator is operating. It is much more reliable and accurate to measure the crystal current with a clip-on type oscilloscope current probe. This probe may require an outboard amplifier in order to measure very low drive levels. It is also important to accurately know the series resistance of the crystal under the same operating conditions of frequency and drive level. This information is easily obtained with a network analyzer or a modern crystal impedance meter. While the oscillator designer may not be equipped with such a meter, the manufacturer of the crystal most certainly should be, and resistance data should be provided for at least one, and perhaps several possible drive levels, if variations in drive are expected.

UNDESIRE MODES

Mechanical resonators are not perfect devices. They exhibit many spurious responses, either continuously or over narrow temperature ranges. If a quartz resonator is swept with a R.F. network analyzer, several smaller responses will be seen just above the main response. These are always present in mechanical plate resonators. For oscillator applications, they must be specified to have a lower response than desired mode. The crystal designer can control these to some extent by varying plate geometry and electrode size. These spurious modes are usually similar in nature to the main response, and do not vary in relation to it to any important degree. Other spurious are caused by completely different modes of vibration, and have radically different temperature curves. These may lay unnoticed until a temperature is reached where the two temperature curves intersect. At this one temperature, the spurious mode traps some of the mechanical energy created by the main mode. This causes a rise in the series resistance, usually accompanied by an unacceptable change in frequency. With a very small change

in temperature, the effect will disappear. This is known as an "activity dip", activity being a dimensionless mechanical property which is inversely proportional to resistance. These can also be successfully specified away in most resonators. Any response of the resonator, be it from spurious, or mechanical overtones, may control the oscillator output frequency if phase and gain criteria are met. In some unusual circumstances, the oscillator may run simultaneously on two or more modes. In general, the fundamental response of any mechanical resonator is usually the largest (lowest loss), and the oscillator will run on this response if no other circuit elements are introduced which favor higher frequencies. If the desired frequency is such that the third overtone, begin the first available (mechanical overtones are always odd ordered), is below 15 or 20 MHz, the oscillator may occasionally run at around three times the desired frequency. This may only happen every third or fifth time the unit is activated. The unit may start correctly, but jump to higher overtone when the unit is exposed to a very narrow temperature range, but remain there after the temperature has changed. The best fix for this problem is usually a reduction in overall loop gain. Occasionally a crystal may have a very low resistance at overtone modes as well as the fundamental. In this case it may be useful to specify overtone modes, as spurious and guarantee at least a -3dB difference between the overtone and the fundamental responses. This condition will already exist for 99% of the resonator designs, and is not usually specified.

It is also best not to insert any large reactances which would compete with the Q of the crystal for control of the oscillator output frequency. If this is done (say, for the purpose of adjusting the oscillator frequency), the tuning reactance (usually a variable capacitor) must be accompanied by an equal reactance of the opposite sign in order to bring the total loop reactance back to zero (unless the crystal is designed to operate with that large series reactance, which could cause other problems). If the oscillator is pulled far enough from the series frequency, the rising crystal resistance will lower the loaded Q of the crystal until the reactance slope of these components competes with that of the crystal. This will cause the oscillator to "run" on these components instead of the crystal, the loop being completed by the C_0 of the crystal. The component with the steepest reactance slope will control the frequency of the oscillator. The tuning sensitivity of these components will also be directly proportional to the magnitude of their reactances. Any unwanted variation of these components will have increased consequences for the stability of the oscillator. Another source of spurious is a relaxation mode which is caused by the amplifier bias circuits and the phase shift capacitors. The loop is completed through the crystal C_0 . Again, a series resistor will usually solve this problem, although in some cases the amplifier bias values may need to be changed.

Load Capacitors

In gate or logic type oscillators, the crystal is usually manufactured to be slightly inductive at the desired frequency, and this inductance is canceled by the two phase shift capacitors. The primary purpose of these capacitors is to provide the phase shift necessary for the oscillator to run. Their actual value is relatively unimportant except, as a load to the crystal, and as they load the output when no series resistor is used. These reactances are the sum total of selected fixed capacitors, any trimmer capacitors which may be desired, and circuit strays. If a loop is considered from one crystal terminal through one phase shift capacitor through ground and the second phase shift capacitor, to the second crystal terminal, all the reactances including the crystal motional parameters must add up to zero, at the desired operating frequency.

As a crystal load, all circuit reactances external to the crystal should be thought of as a series equivalent. In order to know the total load reactance seen by the crystal, the total shunt reactances on either terminal are summed, and the series equivalent is calculated. This should include the OSC1 and OSC2 terminal reactances, but these are negligible if they are sufficiently small when compared to the phase shift capacitors. The value of these capacitors, is then chosen to be twice the specified load capacity of the crystal. If some adjustment of the frequency is necessary, one of the phase shift capacitors can be chosen at a smaller value, and the difference made up by a variable capacitor placed across it. An alternative method is to place a larger value trimmer capacitor in series with the crystal. The value of the trimmer capacitor must be chosen along with the phase shift capacitors, all in series, to give the correct load capacity. Frequency should not be adjusted by shunting the crystal with a capacitor. If it is desired to use a crystal which is finished at series resonance, an inductor of equivalent reactance to half of the phase shift capacitor, must be placed in series with the crystal.

STABILITY

General

Frequency stability is the tendency of the oscillator to remain at the desired operating frequency. Its deviation from that frequency is most conveniently expressed as a dimensionless fraction, either in parts per million (PPM) or a percentage. Absolute deviations in Hz must always be referenced to the operating frequency, which is less convenient and not universal. In the following discussion of temperature characteristics, one can see that the fractional deviations are universal without any direct effect of operating frequency. In order to calculate a total frequency stability, various separate elements must be identified and quantified. Not all parameters of frequency stability are important to each design. The various items which effect the frequency of an oscillator are: the temperature profile of the resonator, the reso-

nator's room temperature frequency tolerance (also known as "make tolerance"), its long term frequency drift which is normally known as ageing, and its sensitivity to other circuit reactances. Is it possible to adjust it to the exact desired frequency? If not, how big is the error due to other component tolerances. Due to the complexity of this combination, most crystal manufacturers will offer a standard crystal which is guaranteed to be ± 100 PPM over -20°C to $+70^{\circ}\text{C}$, or ± 30 PPM over -0°C to $+60^{\circ}\text{C}$. Note that the temperature coefficients of some of the curves in Figure 7 are much smaller than this over the same temperature range. Large portions of these tolerances are devoted to make tolerances and circuit component tolerances. The room temperature items can be relatively simple to specify in the resonator design. If careful attention is paid to specifying the crystal, or designing the oscillator to accommodate a standard crystal, more of the total stability requirement can be devoted to the temperature profile, or the overall stability requirement can be reduced. The temperature profile, however, is subject to other circuit influences external to the resonator. These may be somewhat more difficult to perceive and control. If, for example, the chosen resonator is an A-T cut or tuning fork type, possessed of a nominal temperature profile of less than 50 PPM over the desired temperature range, external influences, such as capacitor temperature coefficients, may play an important part in the overall stability of the oscillator. If however, a ceramic resonator is chosen, its temperature profile of 40 to 80 PPM/C will dominate the oscillator stability, and 5 or 10 PPM shift from changes in amplifier impedance or capacitor temperature coefficients will not be important. The designer may choose a crystal even when the overall stability specification (of the oscillator) does not require it, giving large design margins. If any amount of testing or adjustment of the oscillator frequency is needed with the lower cost resonator, the crystal may be more cost effective. When designing any resonator as part of a simple logic type oscillator circuit (Figure 9), some attention should be given to swapping the amplifier reactances (that is to make them a very small part of the sum total circuit reactance) with the phase shift capacitors, and any other circuit reactances. This is at least, a good design practice. The largest reactance has the most effect on the operating frequency. It follows then that the motional parameters, which have very large reactances, dominate the equation for the total reactance, and so the operating frequency of the oscillator.

Another good design practice, is to specify only as much pullability as is required to accommodate the make tolerance and ageing of the resonator, and tolerance of other circuit elements. Pullability is a function of the ratio of C_1 to C_0 . As the reactance of the crystal C_1 increases it becomes more stable in relation to outside reactive influences. It also becomes more difficult to intentionally adjust its operating frequency. If too high a C_1 is specified, the resonator will be sensitive to external influences, and the effect of these influences may be as large or larger than the temperature profile. If the

C_1 is too small, it may not be possible to adjust the unit exactly to the desired operating frequency. The small electrode size needed to realize a low C_1 may also concentrate the mechanical energy in a very small percentage of the blank, causing unpredictable behavior. In order to quantify pullability in terms of C_1 to C_0 ratio and load capacitance (refer to the Equivalent Electrical Circuit section).

A-T Cuts

The A-T cut crystal and its variations, is by far the most popular resonator in the world today. A-T cut crystals are popular because the "S" shaped temperature curve is centered very near room temperature, typically around 27°C. This temperature profile is compact, symmetrical, and most manufacturers are able to provide good control of the cut angle.

Because most of the crystals manufactured in the last 40 years have been A-T cuts, they are very well understood and documented. This is important because while temperature coefficients can be calculated from the mechanical properties, such as elastic constants, they can (and have been) measured with much more accuracy. When the temperature coefficients are accurately known, the temperature profile can be calculated for an individual set of conditions. Figure 10 is a family of temperature curves of A-T cut crystals used for this purpose. Each curve represents a possible crystal at incremental changes in the cut angle. The practical limit for accuracy of the cut is about ± 1 minute of angle, and in any lot of crystals there will be variations of about ± 1 minute. The designer will create a box around these curves using the desired temperature limits as the vertical sides, and the desired frequency tolerance for the horizontal lines,

as shown in Figure 10. If the curves are spaced at intervals of one minute of angle, then the specification is a practical one if three of these curves (± 1 minute) fit within the outlined area. It is possible to purchase crystals with a closer tolerance, but this is mostly a matter of yields, rather than a better process. The steeply increasing cost will reflect the higher reject rate.

When purchasing a crystal, do not attempt to specify a specific angle, rather specify a frequency deviation between turning points, with tolerances. The mathematics of these curves, is represented by a linear term between two turnover points, whose inflection point is at or near 27°C. The temperature above the high turnover and below the lower turnover, are characterized by cubed terms (very steep). This was described by Bechman in the late 1950s as a third order polynomial. This can be seen in Appendix A. Notice that as the linear portion of the curves between turnover points approaches zero slope, the turnover points move closer together. This tends to limit the temperature range over which very small stabilities can be realized. If the required operating temperature range is inside of the range of the turnover points, a low angle is desirable. If so specified, most manufacturers will provide a crystal with temperature profiles on the order of ± 5 to ± 10 PPM over modest temperature ranges for a reasonable cost. If the desired operating temperature range is outside of the range of turnover points, a higher angle is desirable in order to keep the frequency at extreme temperatures within the same realm as deviation between turnover points. This may approach ± 60 PPM for large temperature ranges, but is still far less than the smallest deviations achievable with other resonators over the same temperature range.

FIGURE 10: FREQUENCY vs. TEMPERATURE CURVE FOR A-T CUT CRYSTAL

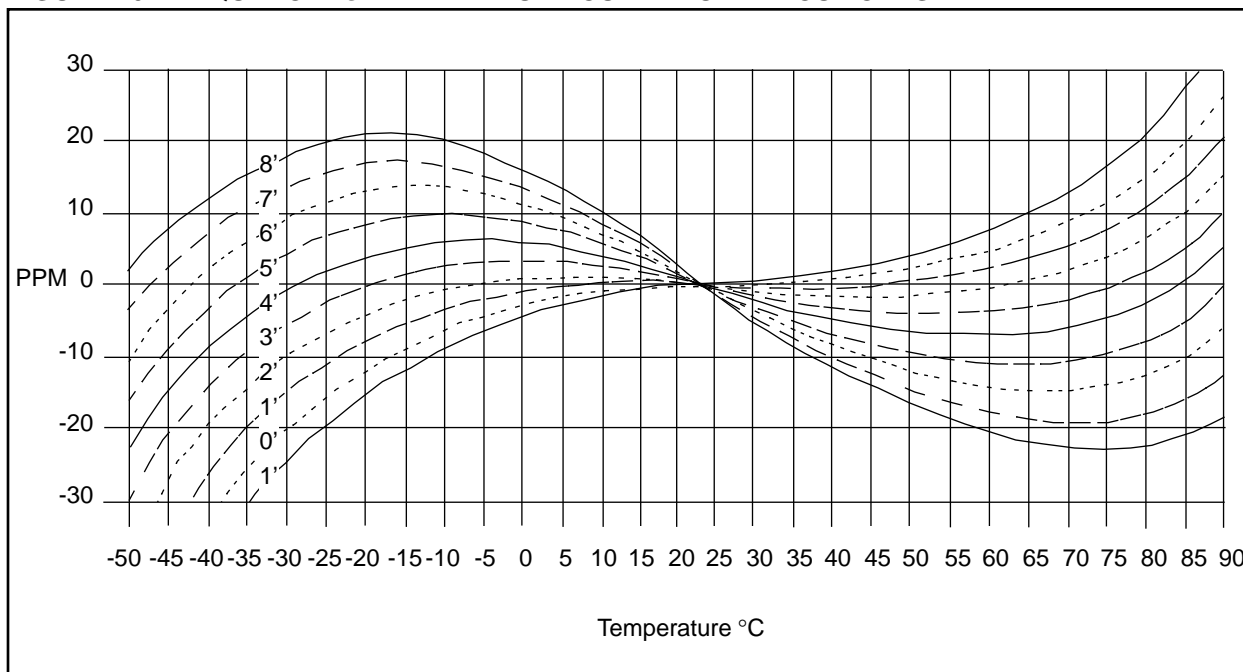

What is not immediately obvious is that if a linear frequency shift with temperature is applied to a frequency curve the result is a rotation of the curve which will eventually match another member of the curve family. There is no other distortion of the temperature curve if the frequency shift is linear, such as from a temperature compensating capacitor. This fact also gives a convenient graphical technique to estimate the effect of temperature coefficients of other components. There exist several flaws in this picture of the A-T cut temperature profile, which may prevent the PICmicro designer from completely realizing the stability suggested by the curves in Figure 10.

The first problem which may arise when choosing a crystal angle based upon these curves, is that there may occur some rotation of the crystal angle due to external circuit influences. The most common influences are that of reactive components (inductors and capacitors). Most inductors have a slight positive temperature coefficient, while capacitors are available in both positive and negative temperature compensating types. Non-compensating type capacitors vary greatly depending on the dielectric from which they are manufactured. The best capacitors for frequency determining elements, are ceramic types with NP0 (flat) temperature coefficients. Avoid at all cost, capacitors made from Z5U material. These have a large temperature coefficient and are unsuitable even for supply line decoupling or D.C. blocking capacitors. This is because a slight change in the R.F. impedance which shunts the VCC and VDD pins, will have an effect

on the output impedance of the amplifier, and so an effect on frequency. The effect will be on the order of a few PPM, and may well be of secondary importance, depending on the stability requirement. A word about D.C. voltages and crystals. It is permissible to place a D.C. voltage across the terminals of the crystal. This does cause a small change in frequency, but that change is not significant for stabilities of ± 5 PPM or greater.

The second problem is one of dynamic temperature performance. When the unit has stabilized at any temperature on the curve, the frequency will agree with the curve. While the temperature is slowing however, the frequency may be in error as much as 5 to 15 PPM depending on the temperature change. This effect is caused by mechanical stresses placed on the blank by temperature gradients. These can be minimized by thermally integrating the crystal, and joining it to a larger thermal mass. One oscillator engineer has been known to attach a block of alumina (ceramic) to both of the crystal pins in order to join them thermally. Any other mechanical stresses placed upon the pins or leads of an A-T cut crystal unit will also result in a dramatic frequency shift (if the unit is not damaged first). This is to be avoided.

FIGURE 11:FREQUENCY vs. TEMPERATURE SPECIFICATION FOR A-T CUT CRYSTALS

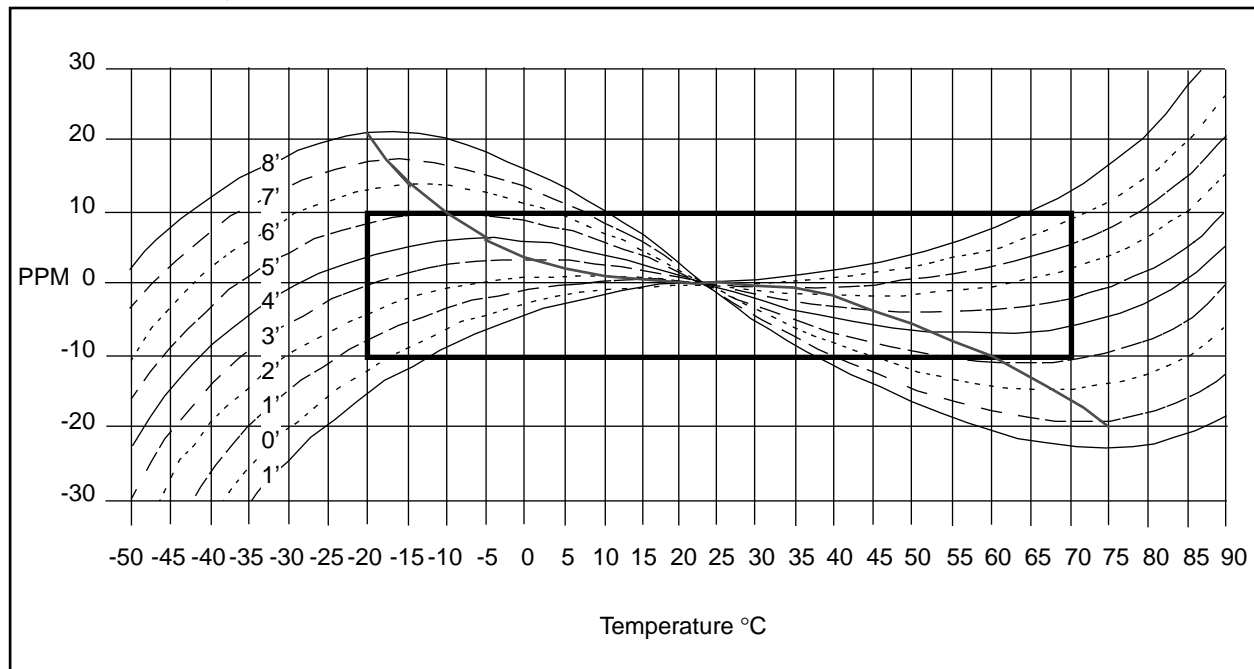

The third item which will cause a deviation from the curves of Figure 10, is spurious response. This is known in the crystal industry as an activity dip. This name originates from a time when the series resistance was referred to as crystal activity, and the frequency change is accompanied by a marked rise in series resistance. This phenomenon occurs when mechanical energy is coupled from the normal thickness shear mode into another undesired mode of vibration. Several other modes are possible for finite plate resonators, and they will usually be resonant at frequencies well away from the design frequency. These modes will often have radically different temperature profiles, and may intersect with the profile of the desired mode at only one very narrow range of temperatures (much less than 1°C). This makes an activity dip difficult to spot in normal testing. Those which are discovered are often around room temperature where temperature changes are more gradual. This coupling between modes is greatly affected by drive level, and the best crystal may exhibit a dip if grossly overdriven. Fortunately, most manufacturers today can produce a crystal which is free of significant dips if so specified. As the accompanying rise in resistance is occasionally large enough to cause oscillation to halt, the PICmicro designer should always specify activity dips to be less than 1 PPM, even if the overall stability requirement is much larger than this. In the interest of low cost and flexibility, the designer may also specify activity dip in terms of a maximum change in resistance.

The other important effect on frequency stability of A-T cut crystals, is ageing. This is the long term frequency shift caused by several mechanisms, the most notable being mass loading of the resonator, causing the frequency to shift ever downward. Because this is the primary mechanism, the cleanliness of the interior of the unit is of prime importance. This is in turn greatly affected by the method used to seal the unit, and the type of holder chosen. If the unit is subjected to excessive drive levels, the frequency may age upwards, indicating electrode material is being etched off of the blank. A good general purpose high frequency crystal using a solder seal holder may be expected to age about 10 to 20 PPM / year maximum. Resistance weld holders will average 5 to 10 PPM / year, and for high stability applications, cold weld crystals are available at ageing rates of 1 to 2 PPM / year. The ageing rates of most crystals will decay exponentially, the most change being in the first year. Ageing rates are different if the unit is operated continuously, but aging will continue even if the unit is not operated.

32 kHz Watch Crystals

The typical 32 kHz watch crystal is a tuning fork type. This is a special case of a flexure mode (N-T cut). The unusual nature of this flexure type is that it is indeed shaped like a tuning fork. This shape gives the crystal a very small size for its low frequency of operation and is almost always manufactured in the NC 38 holder. This is a tube 3 mm x 8 mm. This type is available at frequen-

cies from 10 to 200 kHz, although 32.768 kHz is by far the most popular frequency. The frequency is of course 215, which is ideal for time keeping applications, and being so low is ideal for low-power applications. This type is generally less stable than higher frequency A-T types, but is much better than ceramic resonators, the primary attraction being the possibility of very low operating power drains. The PICmicro LP option was designed with this crystal in mind. It has a parabolic temperature profile of about .04 PPM / (°C)². The turn-over point of the temperature profile is near 25°C. In order to calculate the change in frequency it is only necessary to square the difference in temperature from 25°C and multiply by .04. The temperature profile is shown in Figure 12. The C₁ is on the order of .002 pF, which will make design for frequency adjustment possible but not trivial. The make tolerance is usually about 20 PPM at best, making some adjustment necessary for most applications. The series resistance of this type is very high, on the order of 30,000Ω. It is imperative that care be taken to limit the drive to the crystal. Only a fraction of a mA of crystal current will damage this unit, possibly causing it to cease oscillation. This is best done with a series resistor between the OSC2 pin and the junction of the crystal lead and phase shift capacitor (Figure 12). If the frequency is moving upward in a continuous manner, the drive level is probably too high. A portion of this change will be quite permanent.

Ceramic Resonators

Ceramic resonators are the least stable type available other than the Resistor/Capacitor networks. The temperature profile is a much distorted parabolic function, somewhat resembling that of some capacitors. Temperature coefficient is on the order of 40 to 80 PPM / °C. Typical specified stability for -20°C to +80°C is ± 0.3% (3000 PPM). The C₁ can be as high as 40 pF, making the oscillator extremely vulnerable to circuit influences external to the resonator. The R_s however is on a par with A-T type crystals, at around 40Ω. The positive features of this type are the small size, low cost, and relative simplicity of designing it into a PICmicro part. Because these have a very low Q, the start-up time can be very good, although with the large phase shift capacitors necessary at low frequencies where this would be an advantage, the bias stabilization time will probably dominate the start-up characteristics. If the stability requirements are very modest, this will be a good choice.

R/C Oscillators

The PICmicro parts can be configured to operate with only a resistor and a capacitor as frequency determining elements. This is a very low cost method of clocking the PICmicro. The stability achieved this way is at best only adequate if the only thing required of the oscillator is to keep the PICmicro marching along to the next instruction. The main effects on stability are that of the switching threshold of the OSC1 input, and the temperature coefficient of the resistor and capacitor.

FIGURE 12:FREQUENCY vs. TEMPERATURE FOR NC38 TIMING FORK TYPE CRYSTAL

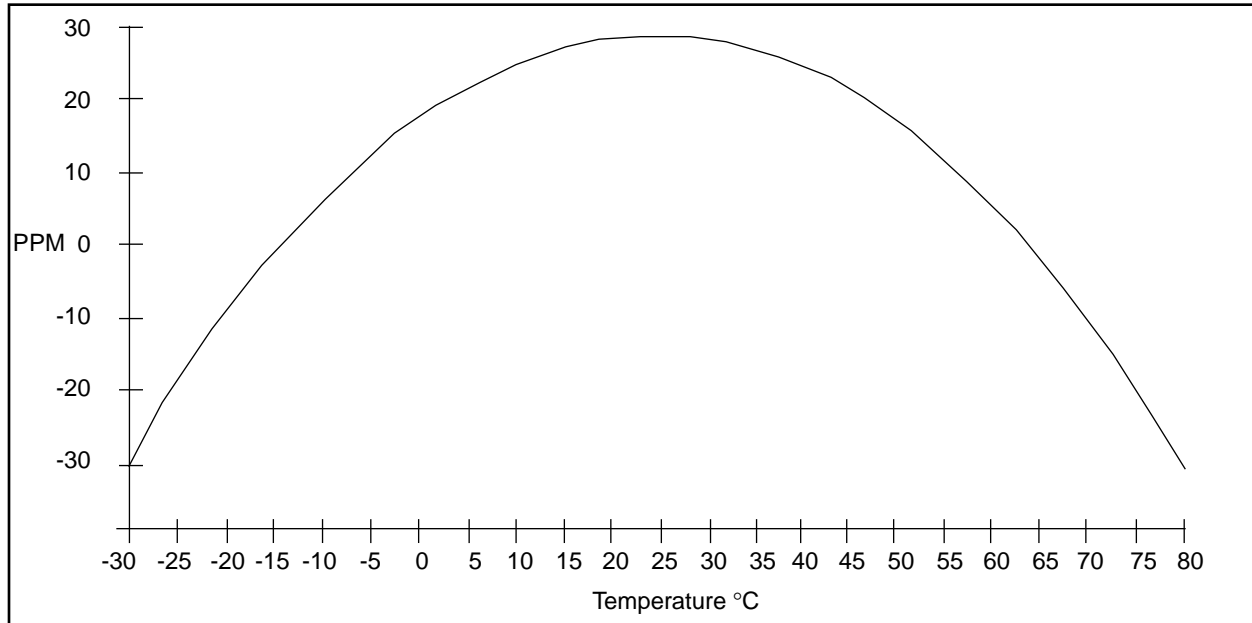

HOW TO CHOOSE A RESONATOR

Type Trade-offs

The primary trade-offs for a designer when choosing a resonator are frequency, size, stability and cost. The lowest cost oscillator is the RC type. This also has the worst stability. The components however tend to be reliable and small, whereas resonators are in general larger and have limitations on the amount of physical punishment they can absorb.

A-T cut crystals have the best overall stability and are available in frequencies from 1 MHz to the upper limit of the PIC16C5X part, and in a roughly 0.5 "square package". T-05s and 0.3 "square packages" are available at higher costs, down to a frequency of around 5 MHz. A-T cut crystals also have a smaller overall temperature profile which the designer has the best chance of specifying and controlling. Temperature stabilities on the order of ± 10 PPM are possible over modest temperature ranges. The A-T cut can be sufficiently reluctant to move off frequency, in response to parasitic reactance changes, that it can fully realize these small deviations over temperature. Such is not always the case with other resonator types or incorrectly specified crystals.

Ceramic resonators offer smaller size and slightly lower cost, although in large quantities, microprocessor grade crystals (± 100 PPM) can be competitive. Ceramic resonators will, however, suffer from temperature stabilities in the 0.3% to 0.5% region. This is a significant step down from quartz crystals of any kind.

A designer must choose a resonator which is available in the desired frequency range, has acceptable temperature characteristics, has the lowest cost

package which is appropriate for that resonator and is suitable for the mechanical packaging of the oscillator chosen. A-T STRIP resonators are normal A-T cut resonators in which the resonator blank is cut in a long strip rather than a disc, and the electrodes cover a much higher percentage of the quartz blank. A standard A-T cut crystal is a thickness mode resonator, and is usually cut in the form of a disk. The electrodes usually cover only a small portion of the blank. The remainder of the blank, not covered by the electrodes, can be thought of as support structure. By removing this support structure, the size of an A-T cut resonator can be greatly reduced. This type of construction violates several rules having to do with thickness to diameter ratios and greatly reduces the overall mass of the blank. This results in reduced performance in the form of slightly less predictable temperature stability, and dramatically reduced power handling capabilities. The A-T STRIPs are generally available up to 20 MHz, depending on the manufacturer.

Tuning Fork type resonators are a type of flexure mode resonators. They are made from quartz, are very small and available at a cost which is competitive with microprocessor grade A-T cut crystals. Tuning forks have a predictable parabolic temperature coefficient, but any drive power in excess of their very low specified level will deteriorate this quickly.

If stability requirements are beyond what is achievable with a good, A-T cut crystal, the next option is to drive the OSC1 pin with an external oscillator. A good Temperature Compensated crystal(X) Oscillator (TCXO) is expensive when compared to crystal resonators. Stabilities of ± 1.0 PPM over large temperature ranges are common.

Price discounts for volume quantities do not always occur, because each unit must be individually compensated. This varies greatly with the stability and temperature range, and so of course does the price, which in any case will be much higher than any resonator, which the PICmicro designer might consider.

Size and Performance

It is generally true that as a designer considers resonators of smaller size, he or she is faced with decreasing overall performance. Even the A-T cut crystal, which has the best stability discussed here, will become less stable as size is reduced, especially when plate area is reduced in relation to the spot as in a STRIP A-T. One important factor is the thermal inertia represented by the mass of the blank. The bigger the blank, the slower it is to follow the changes in temperature. When the blank changes temperature too quickly, it will deviate from the temperature profiles. The frequency will return to this point once the blank has stabilized at the new temperature, but may be well off the profile during a temperature slew. This problem becomes greater as the size of the blank is decreased. Some stability issues are due to the unusual motional parameters associated with certain miniature resonators. Some low frequency types have a C_1 which is larger than the holder capacitance (C_0), making it extremely easy to tune and vulnerable to external influences. Most miniature types have parabolic temperature coefficients which are large enough to make them inferior to A-T cut crystals as well as A-T STRIP cuts, and not only suffer from temperature transient problems as mentioned above, but it is also difficult to control their cut angle and finish frequency. Tuning forks have a somewhat more predictable if larger temperature profile. Almost all miniature types will not perform well (or sometimes at all) with excessive drive levels. The drive power to the resonator must be controlled, and usually one resistor is sufficient.

Cost and Performance

The lowest cost timing system, of course, is the RC type. This rugged, low cost and small timing system is useful only for the most forgiving timing applications. If all you need is something to keep the PICmicro moving, this is a good choice. The next step in cost is most likely the ceramic resonator. Its size is smaller than most A-T cut crystals, but its frequency stability is measured in percent, rather than PPM. A high C_1 also makes it vulnerable to external influences.

Tuning fork types, like all others, vary in price. They may cost less than the ceramic resonator, if a standard frequency is acceptable, or may cost more than an A-T cut if a nonstandard frequency is ordered. Tuning forks usually have a very low C_1 contributing to overall stability. This may actually make it difficult to trim to frequency. Tuning forks have a relatively controllable parabolic temperature curve. A-T cuts have the best overall stability but their cost varies greatly. A-T cuts have an additional advantage in that their temperature

profile is the most easily controlled. This offers some flexibility in specifying the angle of cut. A low angle may be order for minimum deviation near room temperature, or a high angle may be ordered to give minimum deviation at extreme temperatures. Standard frequencies and loose specifications for motional parameters will yield cost and delivery competitive with ceramic resonators. Any nonstandard parameters will raise the cost quickly and almost certainly rule out any "off the shelf" part. It will be necessary to specify a nonstandard crystal, if the greatest possible stability is to be "wrung out" of an A-T cut crystal.

Packages

Quartz crystals have a large and mostly obsolete stable of resonator holders to choose from. This is because of the much longer history of quartz crystals. Most of the nomenclature used to describe them, and the technology used to develop them, comes from the MIL-STD system. These include the H/C 6, which is about .750" square, and is only necessary to accommodate the lowest frequency A-T cut. The H/C 43 is only about .500" square, and probably accounts for most of the crystal production in the world today. The H/C 45 is still smaller at about .350" square. There are many other standard part numbers which are variations of these, with pins or wire leads, thin version and short versions, and several different methods of sealing the package. Most manufacturers offer their own nonstandard variations of these, as well as clever ways to surface mount them. Most of these variations however, have their origins in the standard H/C parts. The method used to seal the package will have the greatest impact on price and ageing. Solder sealed crystals are usually the least expensive owing to the modest equipment requirements, and simplicity. Resistance weld is slightly more costly, and cold weld is a distant third. This may be changing as more large volume production is implemented with resistance welded packages. Because more exotic (expensive) materials are involved in the cold weld and resistance weld packages before any crystal is mounted in it, is doubtful that this order of cost will change very much. Both solder sealed and resistance welds leave some residue, which over long periods of time contaminate the blank. This causes long term frequency shifts, known as ageing. Cold welded crystals cost more because of more expensive materials which must be used, and expensive tooling (dies) which eventually wear out. Cold weld packages, if assembled in a clean environment, have the potential for the lowest ageing rates. Glass crystal holders have in the past held a slight advantage in ageing over cold weld types, but in the last several years, cold weld techniques have matured to where they have surpassed the glass holder in performance. Some manufacturers, because of the processes in place, may offer glass at a competitive cost. There is nothing wrong with glass holders, but these have no particular advantage over a modern cold weld package. In any case, the differences in ageing rates will not be important to all but a few PICmicro designers. Most ceramic resonators are only available in two or three packages, depending on the

manufacturer. The most popular is the dip molded, ranging from 0.3" to 0.4" square, with some higher frequencies available in lower profiles. Their major size advantage over crystals, if any, will be in height rather than footprint size.

Design Examples

A communications device that is designed around the PIC16C5X part and requires that connecting units have a close timing relationship. Size is not a primary factor, but cost and stability are. A high clock frequency is desired in order to obtain a good sampling rate of the input signal. The PIC16C5X-HS part is selected for a clock frequency of 8 MHz. An X-T Cut crystal is chosen and specified for a maximum frequency deviation of ± 40 PPM over -20° to $+70^{\circ}$ C. The frequency is too high for a tuning fork type, and the stability is out of the question for a ceramic resonator. An examination of A-T cut frequency deviation / temperature curves show that a ± 1 minute angle tolerance gives ± 30 PPM frequency deviation over temperature. This leaves 10 PPM for ageing over the products five-year life. An A-T STRIP is a choice but at this quantity, the A-T cut in an H/C 43 cold weld type holder, comes in at a lower bid. Since there is space in the assembly, it is chosen.

HOW TO SPECIFY A CRYSTAL

When the PICmicro designer chooses a resonator, whether it is a standard or a custom part, a specification, while not essential, is an extremely good idea. A clear specification covering all items of form, fit and function, will eliminate any possibility of confusion on the part of the manufacturer, and insure the part will be suitable for the application. The specification should communicate your requirements to the manufacturer and be an instrument by which questionable parts may be measured. Time for discussion with the manufacturer of the resonator is when the specification is being written, not after. The designer must have or gain knowledge of what parameters raise the difficulty level of manufacturing the resonator, and so the cost. Items which effect cost and levels at which these items become an issue, may vary between manufacturers. A typical crystal design sheet is shown in Figure 13. The A-T cut crystal is likely to have the most detailed specification. Other types of resonators will follow this general form with differences being mostly that of omitting many items. This data sheet is likely to become a document in a drawing package for design of a larger assembly, so the sheet begins and ends with blocks for a drawing number, sign-offs, and revisions. The title informs the manufacturer that the crystal is intended for use in an oscillator, as opposed to filters, or other applications.

Motional Parameters

The first item in crystal design is frequency and the operating load. This might include series resonance (no load), but the PICmicro designer will almost certainly use a value of about 1/2 of the phase shift capacitors, plus any trimmer capacitors which may be added. It is

customary to use a standard value here such as 20 or 32 pF, but a nonstandard value is not very difficult given modern manufacturing equipment. The frequencies possible with the PICmicro oscillator should not strain the capabilities of most manufacturers.

The second item is the "Make Tolerance". This is the accuracy to which the crystal is manufactured at room temperature. This should be at least as small as the temperature deviation, and a ± 20 PPM should not effect the cost significantly. Avoid tightly specifying this value. Tolerances of ± 10 PPM and less are quite practical but more difficult and will impact cost. If the stability budget does not allow this for at least ± 20 PPM for tolerance of the crystal and associated components, then an adjustable component may be necessary. The added cost of parts and labor to adjust them must be weighed against the cost of tighter make tolerances on the crystal. This decision must be made on an individual basis.

The third item in the design parameters is the mode of vibration. This will be the fundamental mode for almost all PICmicro designers. Other possibilities include the third overtone operation, but many other parts must be added in order to insure operation on only the desired overtone. While there are some advantages to overtone operation, almost all PICmicro designers will specify the fundamental mode. Still, what may be obvious to the PICmicro designer must be conveyed to the crystal designer, and so this item should not be omitted, or minimized. Series resistance is usually a "not to exceed" value. A good fundamental mode crystal in the PICmicro operating frequency range will not be above 10 or 15 Ω , although the oscillator may run with a higher value. This depends on the frequency and excess gain available from the particular model of the PICmicro part, at that frequency. The higher resistance will mean more power dissipated in the crystal, and for this reason a nominally lower value should be adhered to. The load capacity will have an effect on this value. The practically achievable series resistance will rise as the load moves the operating point away from series resonance and towards anti-resonance (Figure 12).

The motional capacitance, or C_1 , may be the most troublesome item for the PICmicro designer to specify. This item will have the single largest effect on the tuning sensitivity (intended or unintended) of the oscillator. Additionally, if the C_1 is specified to be too small, the crystal designer, who controls C_1 by adjusting the electrode size, will use a very small electrode. This will result in the drive power being dissipated by a small portion of the crystal blank, making drive related areas, such as activity dips and other spurious, more critical. If a large C_1 is specified, the unit may be unnecessarily less stable. The static capacitance or C_0 , is usually a "not to exceed" value, and it is not of much interest to the PICmicro designer unless a large and specific degree of adjustability is required from the oscillator. This may be important if an electrically tunable oscillator is desired. In this case, a specific ratio of C_1 to C_0 could

be specified. This would not be a low-cost item. It is customary to leave this blank if a specific value is not desired, or the words "as required" can be placed in that location.

Other alternative methods of specifying C_1 and C_0 might include a fractional frequency deviation between series and load capacity operation. The drive level should indicate the highest drive level which the PICmicro designer estimates the crystal will experience in operation. The crystal designer would like this value to be very low, rendering it a nonissue. The PICmicro designer must specify a practical maximum value and take steps to insure that it is not exceeded. Operation at spurious modes and activity dips are just two of the possible consequences of excessive drive levels. Activity dips are not to be tolerated if reliable operation is expected. To quantify this, a maximum allowable value is placed on the frequency deviation. This should be less than 1 PPM and must be less than 5 PPM at reasonable drive levels (i.e., less than 1 mW). The maximum permissible drive level is determined somewhat by the size of the blank, the electrode, and therefore the size of the holder chosen. The crystal manufacturer should offer a realistic value.

Temperature Characteristics

The crystal manufacturer must know the temperature range over which operation is intended, and this is the first item under the heading of temperature characteristics. The temperature profile of an A-T cut crystal is controlled by the angle of cut. The desired profile is also chosen in terms of angle. When purchasing a crystal however, do not attempt to specify an angle. These angles are referenced to the crystal's atomic lattice, and are calibrated using an X-ray diffraction technique. There is little direct correlation between manufacturers. Once again the measured results, in the form of measured temperature profiles, are much more accurate, and are the final word in any process control. The PICmicro designer should specify a fractional frequency deviation with tolerances between the turning points of the temperature profile. This is the accepted industry standard for specifying temperature performance, and any crystal manufacturer will readily accept it if the tolerances are realistic. A typical temperature profile might read; "turn-to-turn 5.5 PPM, + 5.0, - 3.5".

Packages

The type of package and the method of sealing it should be specified, although it may be useful on occasion to leave this item blank. Some manufacturers are equipped especially well for a particular type of holder or sealing process, and may offer a better package than required, at a competitive price. In general however, it is best to specify this at the outset. Package types (holders) greatly effect the price of a crystal. The primary performance effect is that of ageing, though other factors, such as thermal characteristics may also be effected.

Other Resonators

Specification of the NC-38 type crystal is limited to motional parameters, as it is not a "rotated" cut. There is little the crystal designer can do to alter the temperature profile. Specifying a ceramic resonator is mostly a matter of custom frequencies, but some control of motional parameters and package variations are possible, though not common. The large temperature profile tends to dominate all other considerations.

Crystal Example

The following is a specification for a 10 MHz A-T cut crystal which the PICmicro designer is likely to choose for a high stability application. The frequency tolerance is ± 20 PPM. A rather modest C_1 of .028 pF $\pm 20\%$ is specified and the C_0 , though not specified, will be around 5 to 7 pF. It is required to operate on frequency with a 32 pF load. The maximum drive level is 1 mW, and no activity dips greater than 3 PPM will be accepted. The crystal will operate over the temperature range of - 20°C to + 70°C. The frequency deviation between turnover points, is 5.3 + 4.5, - 3.2 PPM. Notice that the turning points do not necessarily fall within the operating temperature range (Figure 10). These deviations between turning points correspond to 1, 2 and 3 minutes of angle relative to the zero coefficient angle. Although the 1 minute curve displays a smaller deviation between the turn points, if it were the center of the angle range the lower end of 0 minutes would be unacceptable due to the rapid changes at the ends of the operating range, where cubed terms are in effect. The exact deviations were computer generated for each crystal angle. These offer more detail and accuracy than is possible with graphical techniques. An alternate method of specifying this is to set a total deviation over the entire operating temperature range of about ± 8 PPM. This is not as exact, and leaves the manufacturer more freedom to interpret requirements. If the PICmicro designer is not comfortable with these concepts, this may be the best approach. One may notice a small dissymmetry in the turning deviations. This is because the chosen operating temperature range is symmetrical at about 25°C, and the inflection temperature of the A-T cut is closer to 27°C or 28°C (Figure 10). In some cases the center of the operating temperature range may be very different from the inflection point of the crystal, and in order to realize the benefit of the best angle, a frequency offset at 25°C would be needed to center the temperature profile (this would not be part of the design sheet). The package is chosen to be an H/C 49 type which has a resistance weld seal. A maximum ageing rate of 2 PPM / year is required. No unusual shock or vibration is expected for this unit. Under the area of testing, temperature testing is required only on a sample of the lot. All units will be exposed to a thermal shock, and 10 days of ageing at 85°C. Ageing is of concern, so gross leakage is specified to be tested on all the units, and a fine leak test is to be performed on a 13% sample. Any notes about the application or special concerns would complete the crystal design sheet.

THE PICMICRO ON BOARD OSCILLATOR(S)

PICmicro devices actually contains four complete oscillators which can be selected during the programming process. The selected oscillator is connected to the OSC1 and OSC2 pins, as well as the chip clock drivers by CMOS switches. In the windowed parts, these are all available to the programmer, while the OTP and QTP parts are pre-configured at the factory, and must be ordered as the desired type. The four types of oscillator available in the PIC16C5X/16CXXX series are:

- RC (resistor capacitor)
- LP (low power)
- XT (crystal < 4 MHz)
- HS (High speed)

The four types of oscillator available in the PIC17CXXX series are:

- RC (resistor capacitor)
- LF (low power)
- XT (crystal < 4 MHz)
- EC (External Clock)

The four circuits are shown in Figure 8. This unique arrangement gives the designer the ability to optimize the performance of the PICmicro in terms of clock speed, type of resonator, and power consumption.

The RC Oscillator

The RC oscillator is a relaxation type similar to the popular 555 timer. The OSC1 pin is the input to a Schmitt Trigger.

The LP oscillator

The LP, or low power oscillator, is designed to trade speed for low power operation. Although this circuit shares the same topology (schematic) as the XT oscillator, the transistors used in the LP oscillator have a higher R_{dss} value and draw considerably less current. This configuration is optimum for low frequency operation, because it trades the away unnecessary high frequency responses for dramatically reduced operating currents.

The XT oscillator

The XT oscillator is designed to give a compromise between high frequency performance and modest power consumption. The gain of this oscillator is as much as 15 times higher than the LP oscillator. This middle range will be used for frequencies up to 4 MHz.

The HS oscillator

The HS oscillator is designed to give the maximum gain and frequency response. The current consumption is accordingly higher. The gain is roughly five times higher than that of the XT oscillator. This gives the PICmicro the ability to operate at frequencies up to 20 MHz.

FIGURE 13: CRYSTAL DESIGN SHEET

XYZ INC.	CRYSTAL DESIGN and TEST
DRAWN _____ DATE _____	
APPROVED _____ DATE _____	
FREQUENCY @ LOAD _____	OPERATING TEMPERATURE RANGE _____
MAKE TOLERANCE _____	Frequency Deviation _____ _ From Turn to Turn _ Over Operating Temperature range
MODE OF VIBRATION _____	
SERIES RESISTANCE _____	
MOTIONAL CAPACITANCE _____	PACKAGE _____
STATIC CAPACITANCE _____	TYPE OF SEAL _____
DRIVE LEVEL _____	ENVIRONMENTAL:
SPURIOUS _____	VIBRATION _____
ACTIVITY DIPS _____	SHOCK _____
AGEING _____	
CRYSTAL TEST	
TEMPERATURE _____	GROSS LEAK _____
THERMAL SHOCK _____	FINE LEAK _____
AGEING _____	
NOTES	

FIGURE 14:EXAMPLE CRYSTAL DESIGN SHEET

XYZ INC.	CRYSTAL DESIGN and TEST
DRAWN _____ DATE _____	
APPROVED _____ DATE _____	
FREQUENCY @ LOAD <u>10 MHz @ 32 pF</u> MAKE TOLERANCE <u>± 20 PPM</u> MODE OF VIBRATION <u>Fundamental</u> SERIES RESISTANCE <u>25 Ω Max.</u> MOTIONAL CAPACITANCE <u>.028 pF ± 20%</u> STATIC CAPACITANCE _____ DRIVE LEVEL <u>1 mW Max.</u> SPURIOUS <u>< - 3 dB</u> ACTIVITY DIPS <u>< 3 PPM</u> AGEING <u>< 2 PPM / Year</u>	OPERATING TEMPERATURE RANGE <u>20 to + 70°C</u> <div style="border: 1px solid black; padding: 5px; margin-top: 10px;"> Frequency Deviation _____ <input checked="" type="checkbox"/> From Turn to Turn <input type="checkbox"/> Over Operating Temperature range </div> <div style="border: 1px solid black; padding: 5px; margin-top: 10px;"> PACKAGE <u>H/C 49</u> TYPE OF SEAL <u>Resistance</u> ENVIRONMENTAL: N/A VIBRATION _____ SHOCK _____ </div>
CRYSTAL TEST	
TEMPERATURE _____ THERMAL SHOCK _____ AGEING <u>10 Days at 85°C</u>	GROSS LEAK <u>100%</u> FINE LEAK <u>13% AQL</u>
NOTES	

APPENDIX A

The curves of Figure 10 are calculated using a general form developed by Bechmand in 1955. For any temperature T , a fractional deviation from the frequency at the reference temperature T_0 , is given in the form:

$$\frac{\Delta F}{F} = a(T - T_0) + b(T - T_0)^2 + (T - T_0)^3$$

where:

- a = $-5.15 \times 10^{-6} \text{ }^\circ(\theta - \theta_0)$
b = $0.39 \times 10^{-9} - 4.7 \times 10^{-9} \text{ }^\circ(\theta - \theta_0)$
c = $109.5 \times 10^{-12} - 2 \times 10^{-12} \text{ }^\circ(\theta - \theta_0)$
($\theta - \theta_0$) = the difference between the intended angle and the zero temperature coefficient angle, in degrees of arc.

T_0 is the reference temperature and is usually taken as 25°C. The zero temperature coefficient angle is approximately - 35.25° relative to the Y-axis. The exact angle which produces a zero temperature coefficient and the exact inflection temperature are both strongly dependent on several factors, including overtone and resonator geometry. A degree as a unit of angle is too coarse for sufficient resolution. The following coefficients are divided by 60 for units of minutes of arc.

REFERENCES AND BIBLIOGRAPHY (HIGHLY RECOMMENDED READING)

Ferking, M.E., *Crystal Oscillator Design and Temperature Compensation*, Van Norstrand Reinhold, New York, 1978.

Parzen, B., *Design of Crystal and other Harmonic Oscillators*, John Wiley and Sons, New York, 1983.

Salt, D., *The HY-Q Handbook of Quartz Crystal Devices*, Van Norstrand Reinhold, CO. Ltd, Berkshire, England.

This application note has been developed by:

Kim Peck
29 Wachusett Road
Needham, MA 02192
(617) 444-7748



WORLDWIDE SALES AND SERVICE

AMERICAS

Corporate Office

Microchip Technology Inc.
2355 West Chandler Blvd.
Chandler, AZ 85224-6199
Tel: 480-786-7200 Fax: 480-786-7277
Technical Support: 480-786-7627
Web Address: <http://www.microchip.com>

Atlanta

Microchip Technology Inc.
500 Sugar Mill Road, Suite 200B
Atlanta, GA 30350
Tel: 770-640-0034 Fax: 770-640-0307

Boston

Microchip Technology Inc.
5 Mount Royal Avenue
Marlborough, MA 01752
Tel: 508-480-9990 Fax: 508-480-8575

Chicago

Microchip Technology Inc.
333 Pierce Road, Suite 180
Itasca, IL 60143
Tel: 630-285-0071 Fax: 630-285-0075

Dallas

Microchip Technology Inc.
4570 Westgrove Drive, Suite 160
Addison, TX 75248
Tel: 972-818-7423 Fax: 972-818-2924

Dayton

Microchip Technology Inc.
Two Prestige Place, Suite 150
Miamisburg, OH 45342
Tel: 937-291-1654 Fax: 937-291-9175

Detroit

Microchip Technology Inc.
Tri-Atria Office Building
32255 Northwestern Highway, Suite 190
Farmington Hills, MI 48334
Tel: 248-538-2250 Fax: 248-538-2260

Los Angeles

Microchip Technology Inc.
18201 Von Karman, Suite 1090
Irvine, CA 92612
Tel: 949-263-1888 Fax: 949-263-1338

New York

Microchip Technology Inc.
150 Motor Parkway, Suite 202
Hauppauge, NY 11788
Tel: 631-273-5305 Fax: 631-273-5335

San Jose

Microchip Technology Inc.
2107 North First Street, Suite 590
San Jose, CA 95131
Tel: 408-436-7950 Fax: 408-436-7955

AMERICAS (continued)

Toronto

Microchip Technology Inc.
5925 Airport Road, Suite 200
Mississauga, Ontario L4V 1W1, Canada
Tel: 905-405-6279 Fax: 905-405-6253

ASIA/PACIFIC

Hong Kong

Microchip Asia Pacific
Unit 2101, Tower 2
Metroplaza
223 Hing Fong Road
Kwai Fong, N.T., Hong Kong
Tel: 852-2-401-1200 Fax: 852-2-401-3431

Beijing

Microchip Technology, Beijing
Unit 915, 6 Chaoyangmen Bei Dajie
Dong Erhuan Road, Dongcheng District
New China Hong Kong Manhattan Building
Beijing 100027 PRC
Tel: 86-10-85282100 Fax: 86-10-85282104

India

Microchip Technology Inc.
India Liaison Office
No. 6, Legacy, Convent Road
Bangalore 560 025, India
Tel: 91-80-229-0061 Fax: 91-80-229-0062

Japan

Microchip Technology Intl. Inc.
Benex S-1 6F
3-18-20, Shinyokohama
Kohoku-Ku, Yokohama-shi
Kanagawa 222-0033 Japan
Tel: 81-45-471-6166 Fax: 81-45-471-6122

Korea

Microchip Technology Korea
168-1, Youngbo Bldg. 3 Floor
Samsung-Dong, Kangnam-Ku
Seoul, Korea
Tel: 82-2-554-7200 Fax: 82-2-558-5934

Shanghai

Microchip Technology
RM 406 Shanghai Golden Bridge Bldg.
2077 Yan'an Road West, Hong Qiao District
Shanghai, PRC 200335
Tel: 86-21-6275-5700 Fax: 86 21-6275-5060

ASIA/PACIFIC (continued)

Singapore

Microchip Technology Singapore Pte Ltd.
200 Middle Road
#07-02 Prime Centre
Singapore 188980
Tel: 65-334-8870 Fax: 65-334-8850

Taiwan, R.O.C

Microchip Technology Taiwan
10F-1C 207
Tung Hua North Road
Taipei, Taiwan, ROC
Tel: 886-2-2717-7175 Fax: 886-2-2545-0139

EUROPE

United Kingdom

Arizona Microchip Technology Ltd.
505 Eskdale Road
Winkers Triangle
Wokingham
Berkshire, England RG41 5TU
Tel: 44 118 921 5858 Fax: 44-118 921-5835

Denmark

Microchip Technology Denmark ApS
Regus Business Centre
Lautrup hof 1-3
Ballerup DK-2750 Denmark
Tel: 45 4420 9895 Fax: 45 4420 9910

France

Arizona Microchip Technology SARL
Parc d'Activite du Moulin de Massy
43 Rue du Saule Trapu
Batiment A - 1er Etage
91300 Massy, France
Tel: 33-1-69-53-63-20 Fax: 33-1-69-30-90-79

Germany

Arizona Microchip Technology GmbH
Gustav-Heinemann-Ring 125
D-81739 München, Germany
Tel: 49-89-627-144 0 Fax: 49-89-627-144-44

Italy

Arizona Microchip Technology SRL
Centro Direzionale Colleoni
Palazzo Taurus 1 V. Le Colleoni 1
20041 Agrate Brianza
Milan, Italy
Tel: 39-039-65791-1 Fax: 39-039-6899883

11/15/99

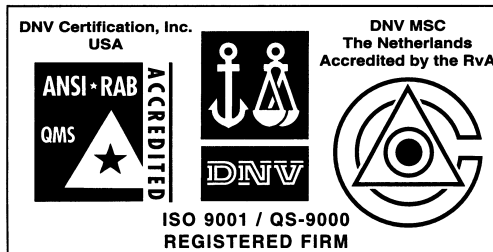

Microchip received QS-9000 quality system certification for its worldwide headquarters, design and water fabrication facilities in Chandler and Tempe, Arizona in July 1999. The Company's quality system processes and procedures are QS-9000 compliant for its PICmicro® 8-bit MCUs, KEELOC® code hopping devices, Serial EEPROMs and microperipheral products. In addition, Microchip's quality system for the design and manufacture of development systems is ISO 9001 certified.

All rights reserved. © 1999 Microchip Technology Incorporated. Printed in the USA. 11/99 Printed on recycled paper.

Information contained in this publication regarding device applications and the like is intended for suggestion only and may be superseded by updates. No representation or warranty is given and no liability is assumed by Microchip Technology Incorporated with respect to the accuracy or use of such information, or infringement of patents or other intellectual property rights arising from such use or otherwise. Use of Microchip's products as critical components in life support systems is not authorized except with express written approval by Microchip. No licenses are conveyed, implicitly or otherwise, under any intellectual property rights. The Microchip logo and name are registered trademarks of Microchip Technology Inc. in the U.S.A. and other countries. All rights reserved. All other trademarks mentioned herein are the property of their respective companies.