



APPLICATION BULLETIN

Mailing Address: PO Box 11400 • Tucson, AZ 85734 • Street Address: 6730 S. Tucson Blvd. • Tucson, AZ 85706
Tel: (602) 746-1111 • Twx: 910-952-1111 • Telex: 066-6491 • FAX (602) 889-1510 • Immediate Product Info: (800) 548-6132

INTERMODULATION DISTORTION (IMD)

By Christian Henn, Burr-Brown International, GmbH

The intermodulation distortion (IMD) performance of wideband, DC-coupled amplifiers is a relatively new area for integrated operational amplifier suppliers. New progresses in IC technology extend the application of op amps where some years ago discrete circuits played the major role. Methods to measure and communicate the extent of this distortion to users have been borrowed from traditional "RF" companies which have historically supplied the radar and radio communications industries, where the importance of it was first highlighted.

Examples of applications demanding good intermodulation distortion include:

- Radar
- Satellite Communications
- Digital Radio Receivers
- Nuclear Particle Research
- CAD Monitor Amplifier

In radar applications good IMD performance is essential, because interference from other radars and jammers often pollute the spectrum. For satellite communications systems, the usable bandwidth for each transponder is limited and multiple signals are frequency multiplied onto one carrier so that signals can interfere with each other when IMD performance is low. For Digital Radio Receivers, a small segment of a broader RF spectrum is digitized and scanned by high-speed data signal processors. For CAD Monitor Amplifiers and for Nuclear Particle Research test equipment, the IMD or as later described the intercept point characterize more precisely than harmonic distortion the large signal capabilities of wideband amplifiers.

INTERMODULATION DISTORTION IN THE OPA622 AND OPA623

The IMD test results in this application note center on new ultra high-speed operational amplifiers available from Burr-Brown—notably, the OPA622 voltage feedback amplifier and the OPA623 current-feedback amplifier.

While the specifications are important and are fully tested, the targeted market segments for these amplifiers clearly called for superior AC performance. Enhanced testing for these parts includes -3dB bandwidth curves for various

gains and output voltage swings, group delay time, settling time, rise time, slew rate, harmonic distortion, and IMD performance. In the remaining sections the application note describes the basics of intermodulation distortions, the relationship between fundamental and 3rd IMD, and shows the test setup and test results for the OPA622 and OPA623.

HARMONIC DISTORTION

When Flash-A/D users talk about distortion they are generally concerned with the spurs introduced into the spectrum of interest. In laboratory conditions harmonic distortion is a major area of concern and is usually measured by inserting a single-tone fundamental into the DUT, then looking at the relevant frequency ($2xf$, $3xf$) to determine the magnitude of the harmonic tones. While this testing is useful to many customers, it does not always appease everyone. Manufacturers who claim to have amplifiers with -3dB bandwidth in the tens of MHz region often test distortion at relatively low tones. While the results are undoubtedly favorable, the user cannot use it for a circuit design. Harmonic distortion also neglects the magnitude of spurs from other sources. Installed in the equipment for which it was selected, there is no guarantee that it will be exposed to a pure spectrum as it is for harmonic distortion measurements. In many cases the amplifier is asked to operate in spectrally-rich environments where intermodulation distortion properties of the amp are of keen interest.

MATHEMATICAL DERIVATION OF INTERMODULATION DISTORTION

The usable dynamic range of an amplifier is limited at very small signal levels by the noise floor and at large signal levels by interferences between signal frequencies. Distortions are caused by non-linearities in the amplitude transfer characteristics. As shown later for producing harmonics, the transfer curve consists of a linear and a quadratic portion and the typical output contains not only the fundamental frequency, but integer multiples of it. IMD results from the mixing of two or more signals of different frequencies and the transfer curve contains in addition a cubic portion. The spurious output occurs at the sum and/or difference of integer multiples of the input frequencies.

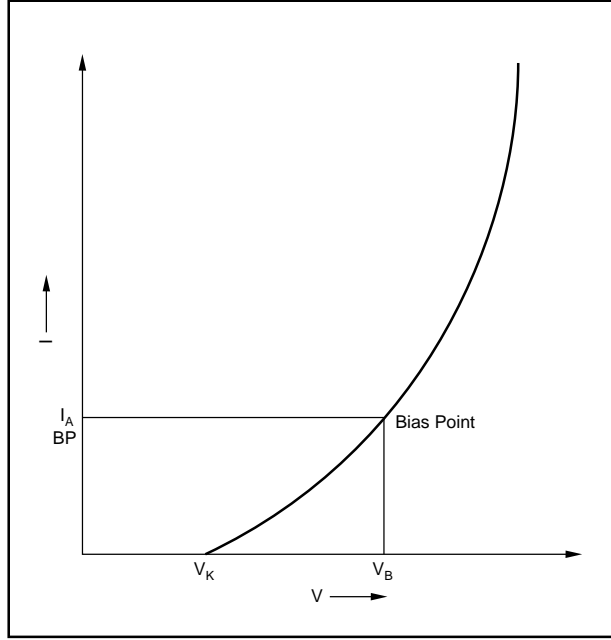

FIGURE 1. Nonlinear Transfer Characteristics.

The non-ideal characteristics of an amplifier can be described by using the Power Series Expansion:

$$V_{OUT} = K_0 + K_1(V_{IN}) + K_2(V_{IN})^2 + K_3(V_{IN})^3 + \dots \quad (1)$$

A one-tone input signal ($V_{IN} = E \sin \omega t$) produces harmonic distortion, a two-tone input signal produces harmonic distortion and intermodulation distortion.

$$V_{IN} = E_1 \sin \omega_1 t + E_2 \sin \omega_2 t \quad (2)$$

Combining equations 1 and 2 results in the following identity:

$$\begin{aligned} V_{OUT} = & K_0 + K_1(E_1 \sin \omega_1 t + E_2 \sin \omega_2 t)^2 + \\ & K_2(E_1 \sin \omega_1 t + E_2 \sin \omega_2 t)^2 + \\ & K_3(E_1 \sin \omega_1 t + E_2 \sin \omega_2 t)^3 + \dots \end{aligned} \quad (3)$$

The first term (K_0) represents the DC offset of the amplifier, the second term is the fundamental signal(s). The subsequent terms represent the distortion of the amplifier. The second IMD can be found by analyzing the third term of Equation 3.

$$\begin{aligned} K_2(V_{IN})^2 = & K_2(E_1^2 \sin^2 \omega_1 t + E_2^2 \sin^2 \omega_2 t + \\ & 2E_1 E_2 \sin^2 \omega_1 t (\sin \omega_2 t)) \end{aligned} \quad (4)$$

Remembering that $[\sin^2 x = (1 - \cos 2x)/2]$ and $[\sin(x)\sin(y) = (\cos(x - y) - \cos(x + y))/2]$ and substituting into Equation 4 provides:

$$K_2(V_{IN})^2 = K_2(E_1^2 + E_2^2) / 2 - \quad (5a)$$

$$(K_2 / 2)(E_1^2 \cos 2\omega_1 t + E_2^2 \cos 2\omega_2 t) + \quad (5b)$$

$$2K_2 E_1 E_2 (\cos(\omega_1 t - \omega_2 t) - \cos(\omega_1 t + \omega_2 t)) \quad (5c)$$

The first and second terms in Equation 5 represent DC offset and second-order harmonics. The third term is the second-order IMD. This exercise can be repeated with the fourth term of Equation 3 to study third-order effects.

$$\begin{aligned} K_3(V_{IN})^3 = & K_3(E_1^3 \sin^3 \omega_1 t + E_2^3 \sin^3 \omega_2 t + \\ & 3E_1^2 E_2 \sin^2 \omega_1 t (\sin \omega_2 t) + \\ & 3E_1 E_2^2 \sin \omega_1 t (\sin^2 \omega_2 t)) \end{aligned} \quad (6)$$

Utilizing the identities, $\sin 3x = 1/4(3\sin x - \sin 3x)$ and $\sin^2 x \sin y = 1/2(\sin y - 1/2(\sin(2x + y) - \sin(2x - y)))$, Equation 6 reduces to:

$$\begin{aligned} K_3(V_{IN})^3 = & (3K_3 / 4)(E_1^3 \sin \omega_1 t + E_2^3 \sin \omega_2 t + \\ & 2E_1^2 E_2 \sin \omega_2 t + 2E_2^2 E_1 \sin \omega_1 t) \end{aligned} \quad (7a)$$

$$(K_3 E_2^3 / 4)(E_1^3 \sin 3\omega_1 t + E_2^3 \sin 3\omega_2 t) + \quad (7b)$$

$$(3K_3 E_2^2 E_1 / 2)(\sin(2\omega_1 t - \omega_2 t) - \frac{1}{2} \sin(2\omega_1 t + \omega_2 t)) + (7c)$$

$$(3K_3 E_2^2 E_1 / 2)(\sin(2\omega_2 t - \omega_1 t) - \frac{1}{2} \sin(2\omega_2 t + \omega_1 t)) \quad (7d)$$

Term (a) from Equation 7 represents amplitude offset at the fundamental frequencies. Term (b) signifies the third-order harmonics. Term (c) and (d) represent third-order IMD.

The result clearly indicates that IMD and crossmodulation only occur on a curved transfer characteristic with cubic terms like term (c) and (d) in Equation 7. In contrast a transfer characteristic with a linear and quadratic portion generates the mixing products (sum and difference) and the harmonics of the input signals.

SOME SIMPLE RELATIONSHIPS

Intermodulation distortion occurs at frequencies that are the sum and/or difference of integer multiple of the fundamental frequencies. For example, assume a composite signal has fundamental frequencies ω_1 and ω_2 . Distortion products will occur at frequencies $a\omega_1 \pm b\omega_2$ where a and b = 0, 1, 2, 3, ...

The following table illustrates this relationship.

2nd-Order Frequencies	3rd-Order Frequencies	
$\omega_1 - \omega_2$	$2\omega_1 + \omega_2$	$2\omega_2 + \omega_1$
$\omega_1 + \omega_2$	$2\omega_1 - \omega_2$	$2\omega_2 - \omega_1$

TABLE I.

Most IMD can be filtered out. However, if the input tones are of similar frequencies, the third-order IMD ($2\omega_1 - \omega_2$, $2\omega_2 - \omega_1$) will be very close to the fundamental frequencies and cannot be easily filtered. Third-order IMD is of most concern in narrow bandwidth applications. Second-order IMD is of greater concern in broad bandwidth applications. Figure 2 below illustrates on a spectrum analyzer the output spectrum of two frequencies (f_1 , f_2) applied to the non-linear transfer characteristic of a mixer with an overdrive level of 10dB.

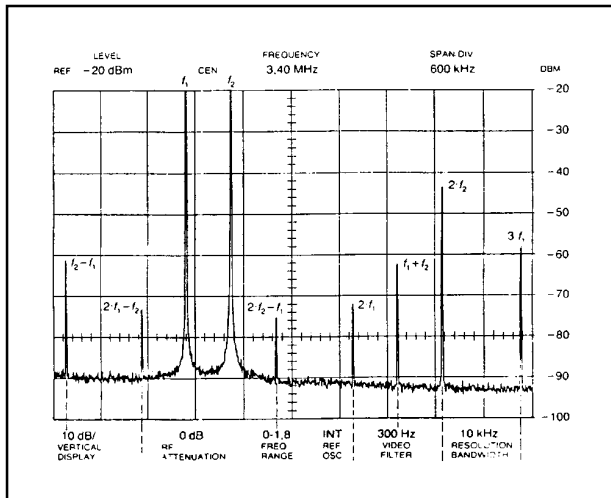

FIGURE 2. Generation of Harmonics and IMD.

Figure 3 shows the 2nd and 3rd IMDs for the condition in which the fundamental terms (ω_1 and ω_2) are 20 and 21MHz sinewaves.

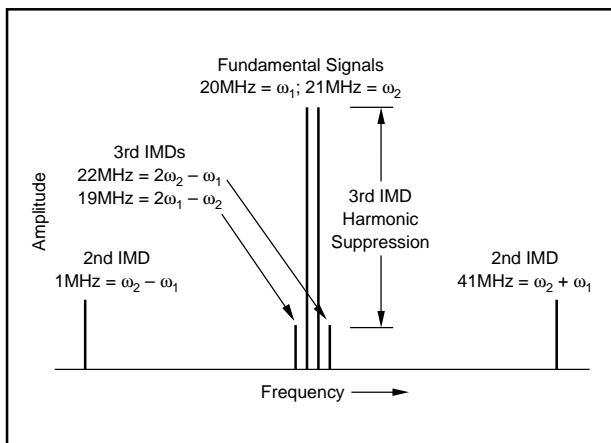

FIGURE 3. Relationship Between Fundamentals and IMDs.

INTERCEPT POINT

The location of the IMDs relative to the fundamental tones has now been defined. The relationship of amplitudes of the IMD tones depends on the order of the IMD. The coefficients of the third-order IMD term in Equation 7 can be used as a starting point in the analysis.

$$\text{Amplitude of 3rd IMD Tones} = 3K_3 E_1^2 E_2 / 2$$

Converting to dB provides:

$$\text{Amplitude of 3rd IMD tone} =$$

$$20 \log(3K_3 / 2) + 20 \log(E_1^2) + 20 \log(E_2)$$

$$\text{Amplitude of 3rd IMD Tone (dB)} = \tag{8}$$

$$\text{constant} + 2E_1 + E_2$$

where E_1 and E_2 are expressed in dB

Equation 8 shows that if the input level (dB) increases, the level of the third-order IM products increases three times faster.

Figure 4 shows the graphic presentation of the theoretical increase of the IMD products when the level increases. The desired output of an amplifier and any IMD can be represented by two straight lines of different slopes. The desired output lines have a slope of +1, any IMD has a slope of n, where n is the order of IMD.

Consequently, the third-order IMD has a slope of 3.

As can be seen in Figure 4 for low level input signals the output tracks the input. At higher input levels Gain Compression occurs at the point where the actual output power drops below the ideal. The -1dB gain compression point is a well accepted performance parameter for RF amplifiers. The intercept point can be found at the intersection of the theoretical line extension of output signal and IMD. The intercept point can be determined from the value of the harmonic suppression (ΔIM) which must be determined experimentally. Equation 9 illustrates this relationship.

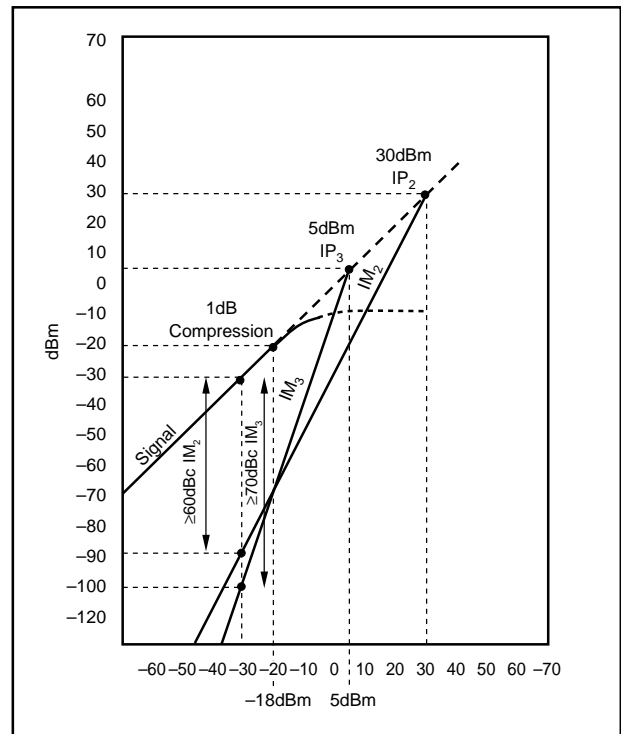

FIGURE 4. Relationship Between Fundamental and 3rd IMD.

$$\text{Intercept Point} = (\text{Harmonic Suppression}) / (N - 1) + (\text{Power of One Fundamental at Output of Amplifier}) \quad (9)$$

By rearranging the Equation 9 the magnitude of third-order products can be easily calculated for any output power (dBm) when the intercept point is known.

$$\begin{aligned} \text{Third IMD} &= 2 (\text{OIP}_3 - \text{PO}) \\ \text{Third IMD} &= \text{third-order intermodulation rasion} \\ &\quad \text{below each output tone (dB)} \quad (10) \end{aligned}$$

One can also make a judgment about the dynamic range of an amplifier with the knowledge about the IP value and the sensitivity (amplifier noise power). A limit for the best distortion-free dynamic range is available when the IM products equal the sensitivity.

For a sensitivity of $P_N = -140\text{dBm}$ at measurement $\text{BW} = 10\text{Hz}$ for an input mixer and $\text{OIP}_3 = +5\text{dBm}$, the best input level can be calculated with Equation 11.

$$\begin{aligned} P_{\text{IN}} &= \frac{(N - 1) \bullet \text{OIP} + P_N}{N} \\ &= \frac{2 \bullet 5 + (-140)}{3} = -43\text{dBm} \quad (11) \end{aligned}$$

The distortion free dynamic range results with Equation 12 to 90dB for narrow spaced input signals.

$$\begin{aligned} \Delta\text{IM} &= \frac{(N_1) \bullet (\text{OIP} - P_N)}{N} \\ &= \frac{2 \bullet 135}{3} = 90\text{dB} \quad (12) \end{aligned}$$

DETERMINING HARMONIC SUPPRESSION

The test system used to measure harmonic suppression is diagrammed below.

1. Set the amplitude of the two inputs equal with the power meter.
2. Check for gain compression by reducing the signal power of both fundamentals by 1dB, then checking to make sure that the 3rd IMD tone is reduced by 3dB. If past the compression point (see Figure 2), then the amplitude of the input to the amplifier should be reduced (repeat Step 1).
3. Measure the harmonic suppression of the 3rd IMD tone on the spectrum analyzer. This is the difference between the magnitude of the fundamental and the 3rd IMD (See Figure 1).
4. Measure the amplitude of a fundamental signal at the output of the DUT by disconnecting one of the signal generators.
5. Calculate the intercept point using Equation 9.

THIRD-ORDER RESULTS FOR THE OPA622 AND OPA623

The 3rd IMD intercept points are measured for the OPA622/623 using fundamental input frequencies from 5MHz to 250MHz with 1MHz spacing between tones. All parts were set up in a gain of +2 and were driven into a 100Ω load.

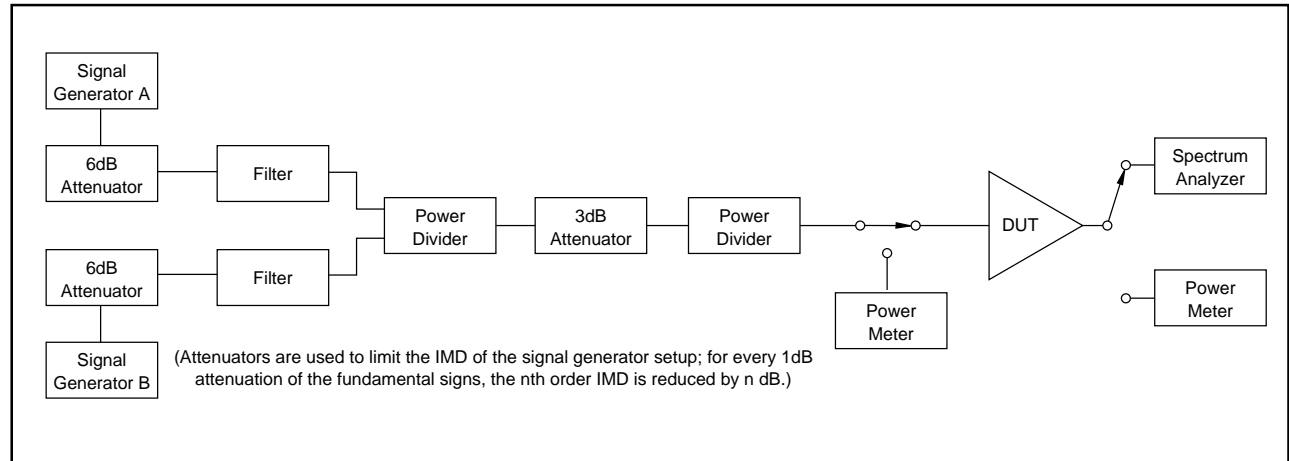

FIGURE 5. Test Setup to Measure Harmonic Suppression.

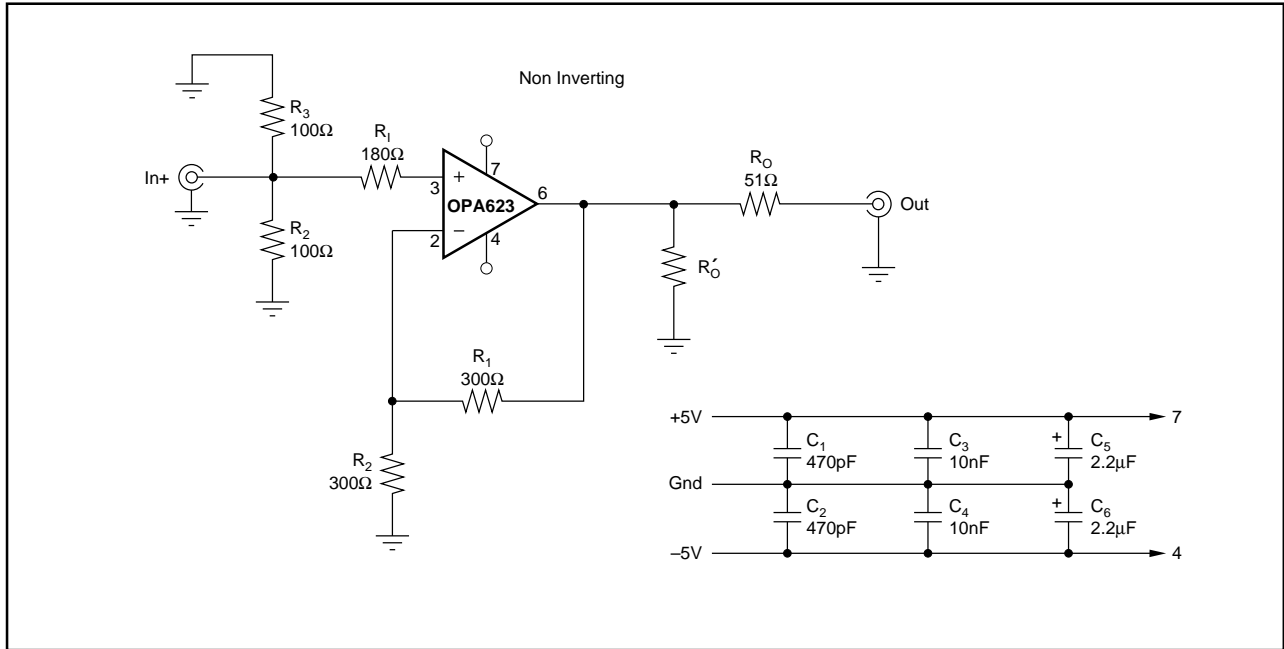

FIGURE 6. Circuit Schematic DEM-OPA623-1GC Used for IMD Performance Tests.

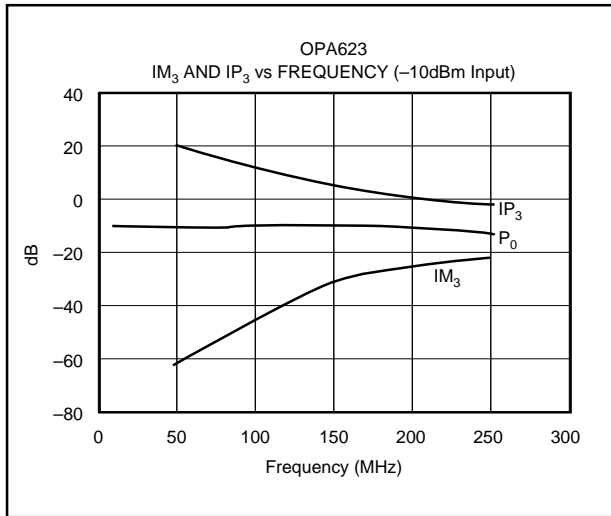

FIGURE 7. IM₃ and IP₃ vs Frequency (-10dBm Input).

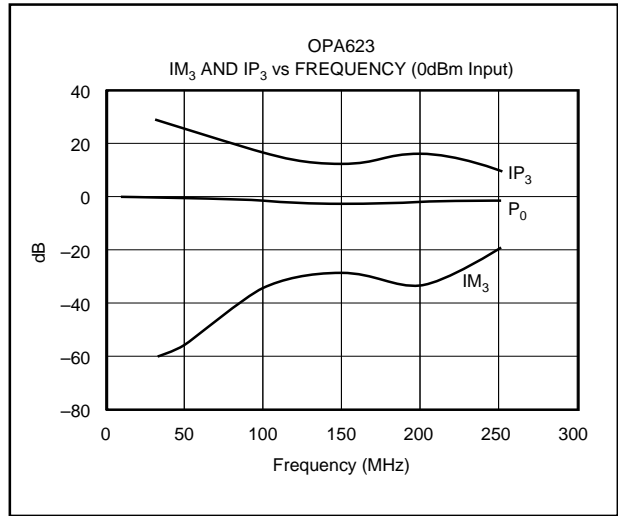

FIGURE 8. IM₃ and IP₃ vs Frequency (0dBm Input).

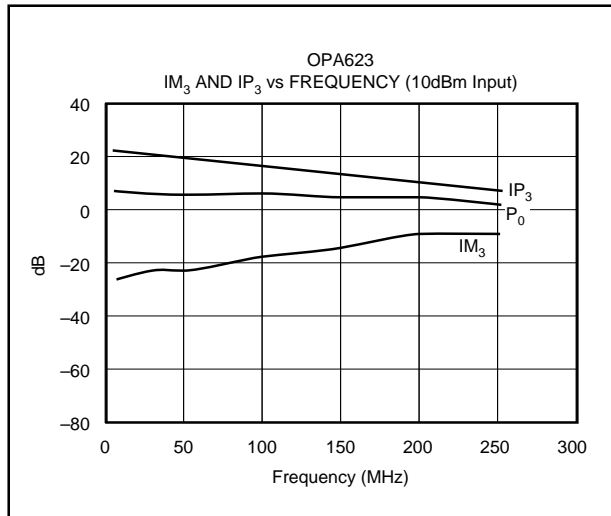

FIGURE 9. IM₃ and IP₃ vs Frequency (10dBm Input).

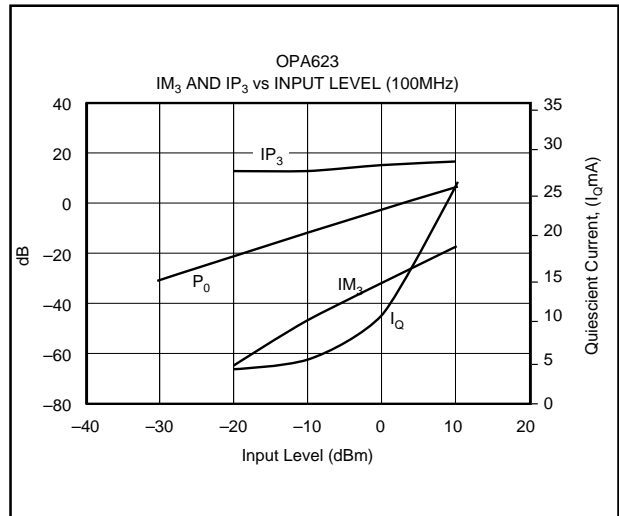

FIGURE 11. IM₃ and IP₃ vs Input Level (100MHz).

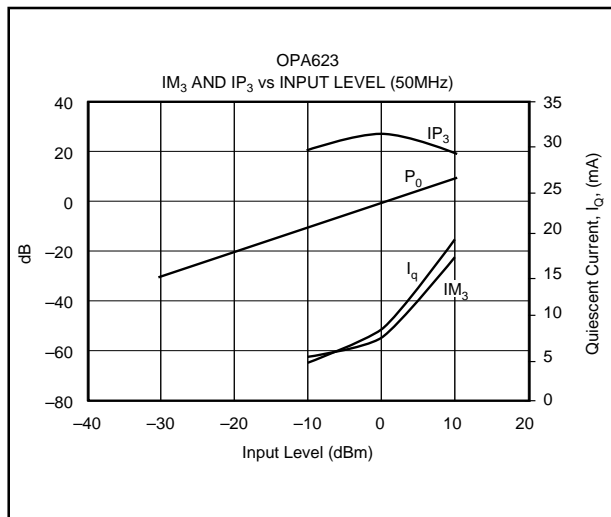

FIGURE 10. IM₃ and IP₃ vs Input Level (50MHz).

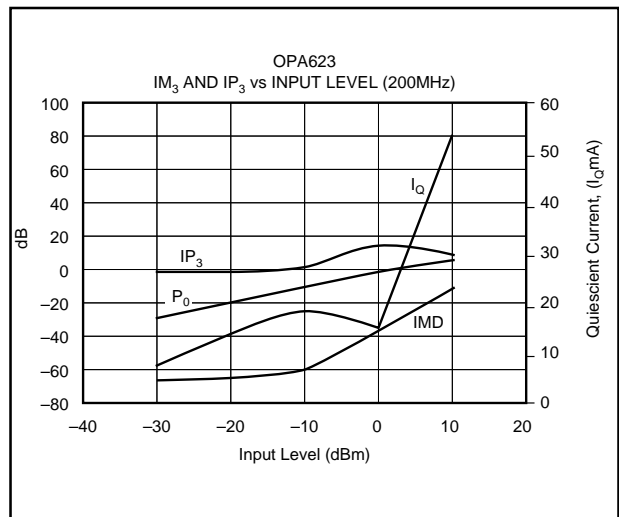

FIGURE 12. IM₃ and IP₃ vs Input Level (200MHz).

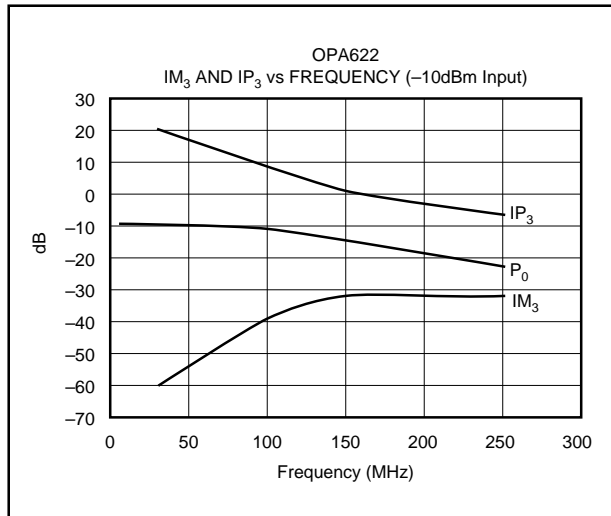

FIGURE 14. IM_3 and IP_3 vs Frequency (-10dBm Input).

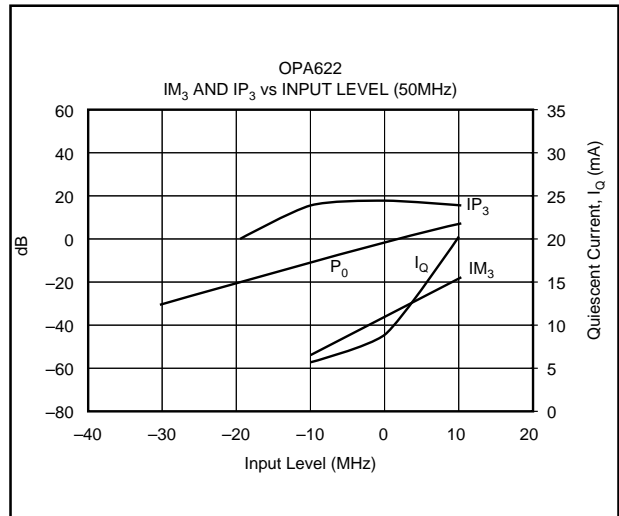

FIGURE 17. IM_3 and IP_3 vs Input Level (50MHz).

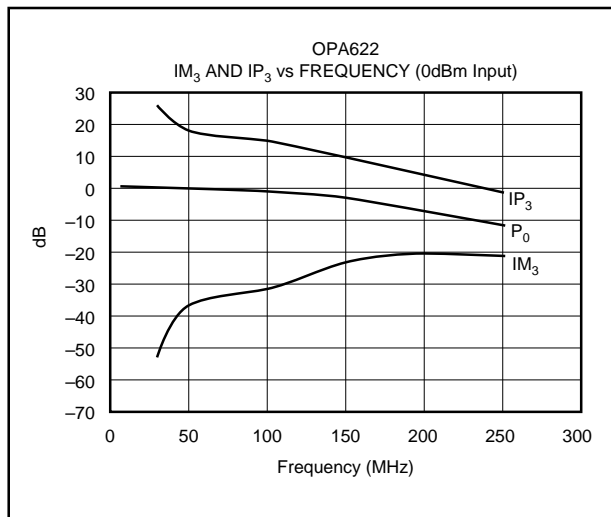

FIGURE 15. IM_3 and IP_3 vs Frequency (0dBm Input).

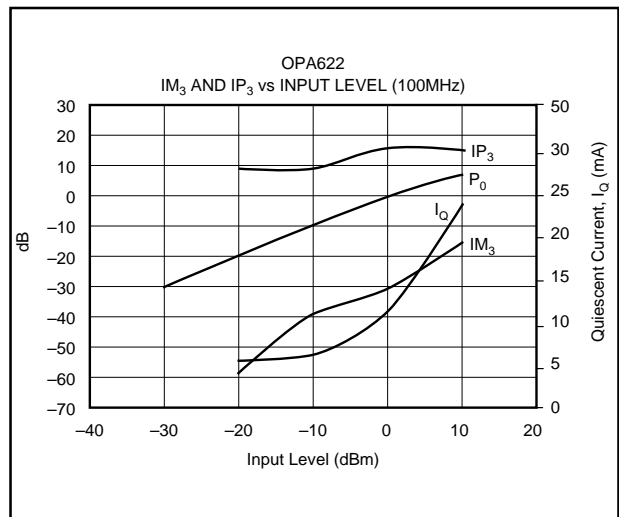

FIGURE 18. IM_3 and IP_3 vs Input Level (100MHz).

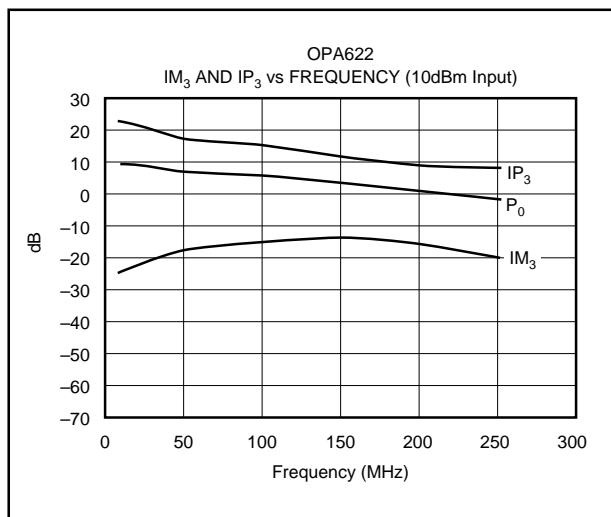

FIGURE 16. IM_3 and IP_3 vs Input Level (50MHz).

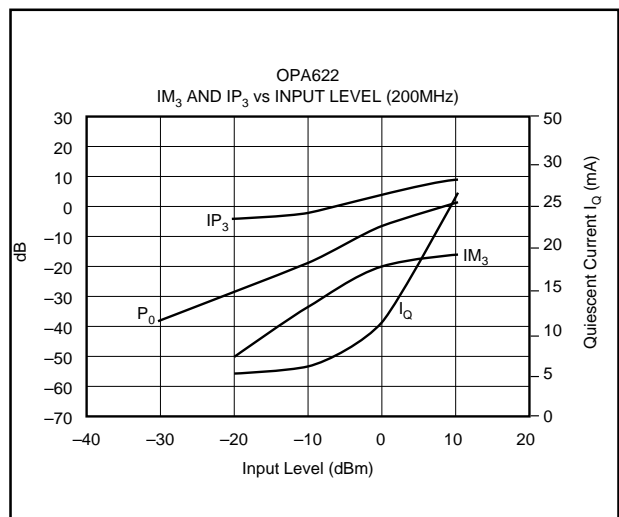

FIGURE 19. IM_3 and IP_3 vs Input Level (200MHz).