

OPA132
OPA2132
OPA4132

High Speed FET-INPUT OPERATIONAL AMPLIFIERS

FEATURES

- FET INPUT: $I_B = 50\text{pA max}$
- WIDE BANDWIDTH: 8MHz
- HIGH SLEW RATE: $20\text{V}/\mu\text{s}$
- LOW NOISE: $8\text{nV}/\sqrt{\text{Hz}}$ (1kHz)
- LOW DISTORTION: 0.00008%
- HIGH OPEN-LOOP GAIN: 130dB (600Ω load)
- WIDE SUPPLY RANGE: ± 2.5 to $\pm 18\text{V}$
- LOW OFFSET VOLTAGE: $500\mu\text{V max}$
- SINGLE, DUAL, AND QUAD VERSIONS

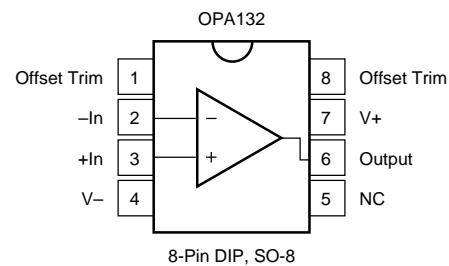

DESCRIPTION

The OPA132 series of FET-input op amps provides high-speed and excellent dc performance. The combination of high slew rate and wide bandwidth provide fast settling time. Single, dual, and quad versions have identical specifications for maximum design flexibility. High performance grades are available in the single and dual versions. All are ideal for general-purpose, audio, data acquisition and communications applications, especially where high source impedance is encountered.

OPA132 op amps are easy to use and free from phase inversion and overload problems often found in common FET-input op amps. Input cascode circuitry provides excellent common-mode rejection and maintains low input bias current over its wide input voltage range. OPA132 series op amps are stable in unity gain and provide excellent dynamic behavior over a wide range of load conditions, including high load capacitance. Dual and quad versions feature completely independent circuitry for lowest crosstalk and freedom from interaction, even when overdriven or overloaded.

Single and dual versions are available in 8-pin DIP and SO-8 surface-mount packages. Quad is available in 14-pin DIP and SO-14 surface-mount packages. All are specified for -40°C to $+85^\circ\text{C}$ operation.

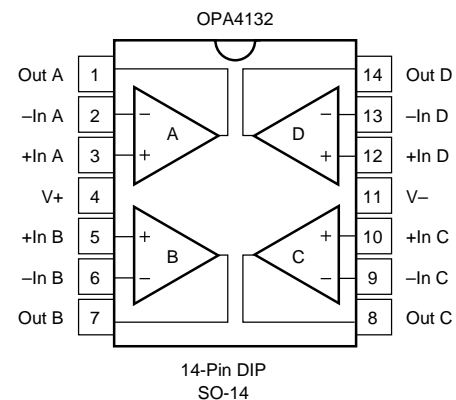
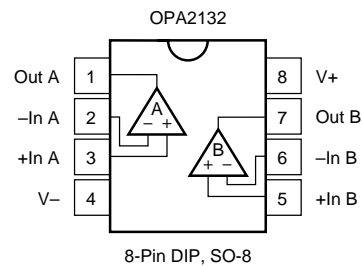

SPECIFICATIONS

At $T_A = +25^\circ\text{C}$, $V_S = \pm 15\text{V}$, unless otherwise noted.

PARAMETER	CONDITION	OPA132P, U OPA2132P, U			OPA132PA, UA OPA2132PA, UA OPA4132PA, UA			UNITS
		MIN	TYP	MAX	MIN	TYP	MAX	
OFFSET VOLTAGE Input Offset Voltage vs Temperature ⁽¹⁾ vs Power Supply Channel Separation (dual and quad)	Operating Temperature Range $V_S = \pm 2.5\text{V to } \pm 18\text{V}$ $R_L = 2\text{k}\Omega$		± 0.25 ± 2 5 0.2	± 0.5 ± 10 15		± 0.5 * * *	± 2 * * 30	mV $\mu\text{V}/^\circ\text{C}$ $\mu\text{V/V}$ $\mu\text{V/V}$
INPUT BIAS CURRENT Input Bias Current ⁽²⁾ vs Temperature Input Offset Current ⁽²⁾	$V_{CM} = 0\text{V}$ $V_{CM} = 0\text{V}$		+5 See Typical Curve ± 2	± 50 ± 50		* * *	* * *	pA pA
NOISE Input Voltage Noise Noise Density, $f = 10\text{Hz}$ $f = 100\text{Hz}$ $f = 1\text{kHz}$ $f = 10\text{kHz}$ Current Noise Density, $f = 1\text{kHz}$			23 10 8 8 3			* * * * *		$\text{nV}/\sqrt{\text{Hz}}$ $\text{nV}/\sqrt{\text{Hz}}$ $\text{nV}/\sqrt{\text{Hz}}$ $\text{nV}/\sqrt{\text{Hz}}$ $\text{fA}/\sqrt{\text{Hz}}$
INPUT VOLTAGE RANGE Common-Mode Voltage Range Common-Mode Rejection	$V_{CM} = -12.5\text{V to } +12.5\text{V}$	(V-) +2.5 96	± 13 100	(V+) -2.5	* 86	* 94	* *	V dB
INPUT IMPEDANCE Differential Common-Mode	$V_{CM} = -12.5\text{V to } +12.5\text{V}$		$10^{13} \parallel 2$ $10^{13} \parallel 6$			* *		$\Omega \parallel \text{pF}$ $\Omega \parallel \text{pF}$
OPEN-LOOP GAIN Open-Loop Voltage Gain	$R_L = 10\text{k}\Omega$, $V_O = -14.5\text{V to } +13.8\text{V}$ $R_L = 2\text{k}\Omega$, $V_O = -13.8\text{V to } +13.5\text{V}$ $R_L = 600\Omega$, $V_O = -12.8\text{V to } +12.5\text{V}$	110 110 110	120 126 130		104 104 104	* 120 120		dB dB dB
FREQUENCY RESPONSE Gain-Bandwidth Product Slew Rate Settling Time: 0.1% 0.01% Overload Recovery Time Total Harmonic Distortion + Noise	$G = -1$, 10V Step, $C_L = 100\text{pF}$ $G = -1$, 10V Step, $C_L = 100\text{pF}$ $G = \pm 1$ 1kHz, $G = 1$, $V_O = 3.5\text{Vrms}$ $R_L = 2\text{k}\Omega$ $R_L = 600\Omega$		8 ± 20 0.7 1 0.5 0.00008 0.00009			* * * * * * *		MHz V/ μs μs μs μs % %
OUTPUT Voltage Output, Positive Negative Positive Negative Positive Negative Short-Circuit Current Capacitive Load Drive (Stable Operation)	$R_L = 10\text{k}\Omega$ $R_L = 2\text{k}\Omega$ $R_L = 600\Omega$	(V+) -1.2 (V-) +0.5 (V+) -1.5 (V-) +1.2 (V+) -2.5 (V-) +2.2	(V+) -0.9 (V-) +0.3 (V+) -1.2 (V-) +0.9 (V+) -2.0 (V-) +1.9		* * * * * *	* * * * * *		V V V V V V mA
POWER SUPPLY Specified Operating Voltage Operating Voltage Range Quiescent Current (per amplifier)	$I_O = 0$	± 2.5	± 15 ± 4	± 18 ± 4.8	* *	* *	* *	V V mA
TEMPERATURE RANGE Operating Range Storage Thermal Resistance, θ_{JA} 8-Pin DIP SO-8 Surface-Mount 14-Pin DIP SO-14 Surface-Mount		-40 -40		+85 +125	* *		* *	$^\circ\text{C}$ $^\circ\text{C}$ $^\circ\text{C/W}$ $^\circ\text{C/W}$ $^\circ\text{C/W}$ $^\circ\text{C/W}$

*Specifications same as OPA132P, OPA132U.

NOTES: (1) Guaranteed by wafer test. (2) High-speed test at $T_J = 25^\circ\text{C}$.

The information provided herein is believed to be reliable; however, BURR-BROWN assumes no responsibility for inaccuracies or omissions. BURR-BROWN assumes no responsibility for the use of this information, and all use of such information shall be entirely at the user's own risk. Prices and specifications are subject to change without notice. No patent rights or licenses to any of the circuits described herein are implied or granted to any third party. BURR-BROWN does not authorize or warrant any BURR-BROWN product for use in life support devices and/or systems.



ABSOLUTE MAXIMUM RATINGS

Supply Voltage, V+ to V-	36V
Input Voltage	(V-) -0.7V to (V+) +0.7V
Output Short-Circuit ⁽¹⁾	Continuous
Operating Temperature	-40°C to +125°C
Storage Temperature	-40°C to +125°C
Junction Temperature	150°C
Lead Temperature (soldering, 10s)	300°C

NOTE: (1) Short-circuit to ground, one amplifier per package.

PACKAGE INFORMATION

MODEL	PACKAGE	PACKAGE DRAWING NUMBER ⁽¹⁾
Single		
OPA132PA	8-Pin Plastic DIP	006
OPA132P	8-Pin Plastic DIP	006
OPA132UA	SO-8 Surface-Mount	182
OPA132U	SO-8 Surface-Mount	182
Dual		
OPA2132PA	8-Pin Plastic DIP	006
OPA2132P	8-Pin Plastic DIP	006
OPA2132UA	SO-8 Surface-Mount	182
OPA2132U	SO-8 Surface-Mount	182
Quad		
OPA4132PA	14-Pin Plastic DIP	010
OPA4132UA	SO-14 Surface-Mount	235

NOTE: (1) For detailed drawing and dimension table, please see end of data sheet, or Appendix D of Burr-Brown IC Data Book.

ORDERING INFORMATION

MODEL	PACKAGE	TEMPERATURE RANGE
Single		
OPA132PA	8-Pin Plastic DIP	-40°C to +85°C
OPA132P	8-Pin Plastic DIP	-40°C to +85°C
OPA132UA	SO-8 Surface-Mount	-40°C to +85°C
OPA132U	SO-8 Surface-Mount	-40°C to +85°C
Dual		
OPA2132PA	8-Pin Plastic DIP	-40°C to +85°C
OPA2132P	8-Pin Plastic DIP	-40°C to +85°C
OPA2132UA	SO-8 Surface-Mount	-40°C to +85°C
OPA2132U	SO-8 Surface-Mount	-40°C to +85°C
Quad		
OPA4132PA	14-Pin Plastic DIP	-40°C to +85°C
OPA4132UA	SO-14 Surface-Mount	-40°C to +85°C



ELECTROSTATIC DISCHARGE SENSITIVITY

This integrated circuit can be damaged by ESD. Burr-Brown recommends that all integrated circuits be handled with appropriate precautions. Failure to observe proper handling and installation procedures can cause damage.

ESD damage can range from subtle performance degradation to complete device failure. Precision integrated circuits may be more susceptible to damage because very small parametric changes could cause the device not to meet its published specifications.

TYPICAL PERFORMANCE CURVES

At $T_A = +25^\circ\text{C}$, $V_S = \pm 15\text{V}$, $R_L = 2\text{k}\Omega$, unless otherwise noted.

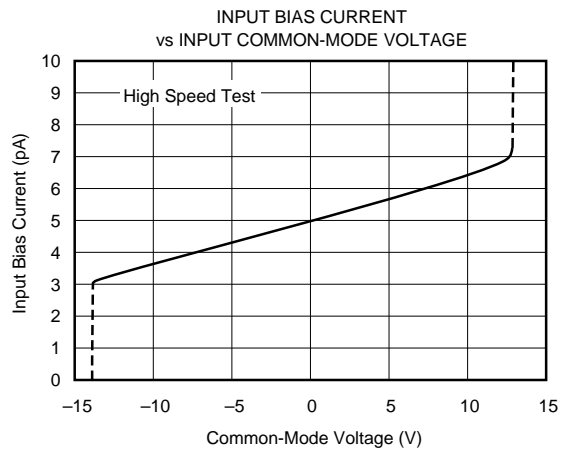
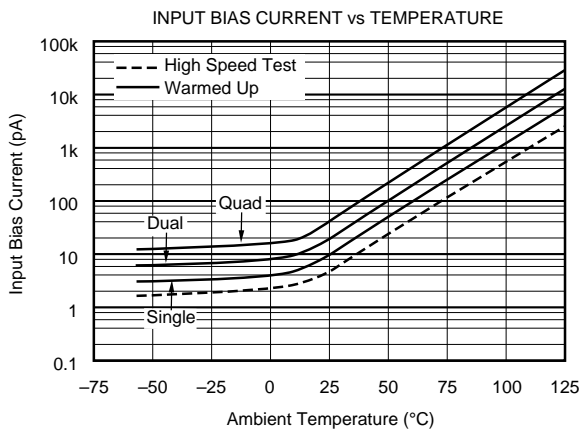
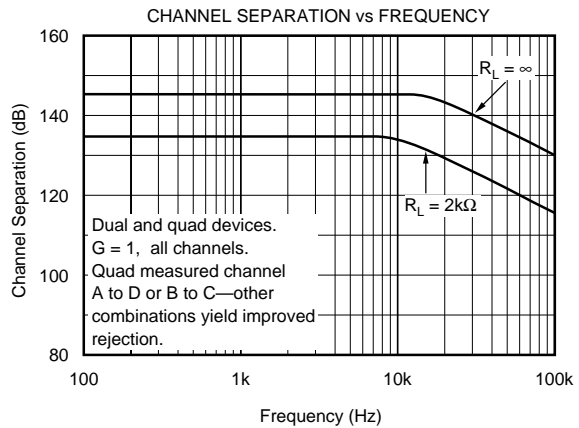
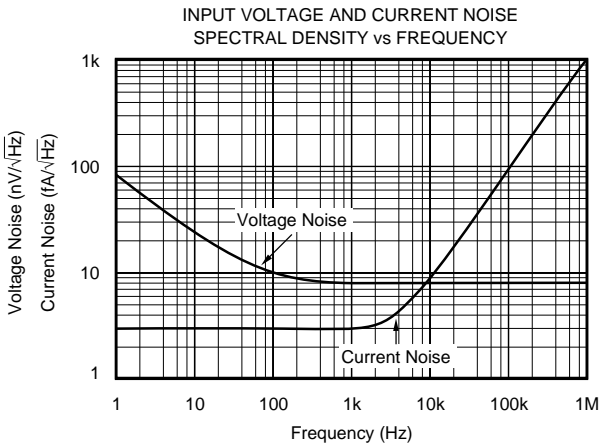
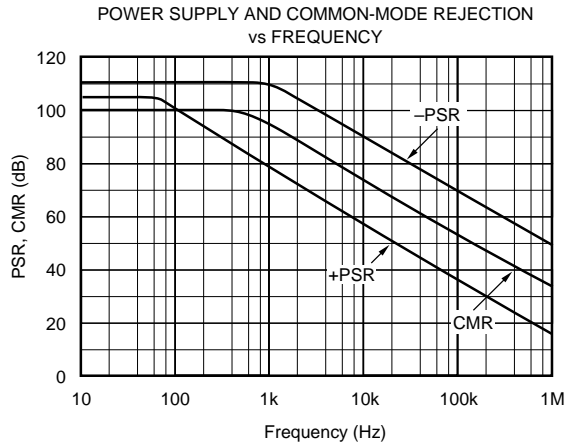
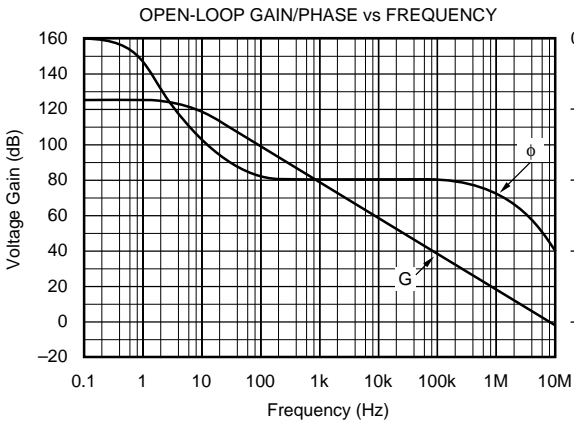

TYPICAL PERFORMANCE CURVES (CONT)

At $T_A = +25^\circ\text{C}$, $V_S = \pm 15\text{V}$, $R_L = 2\text{k}\Omega$, unless otherwise noted.

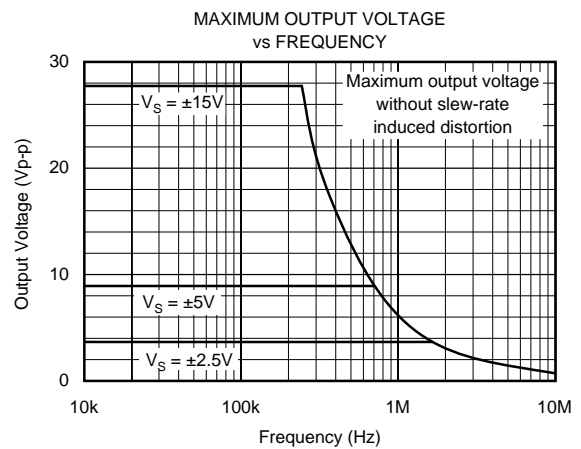
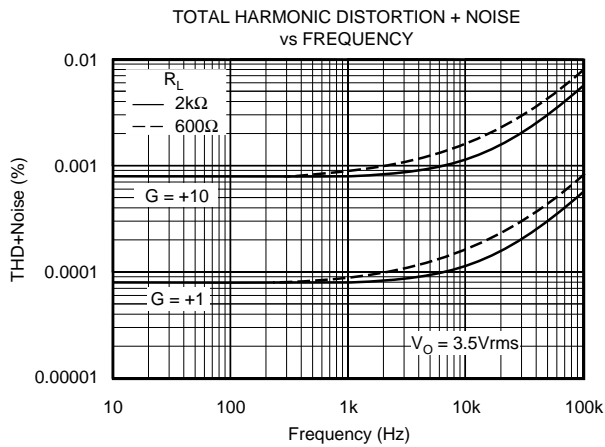
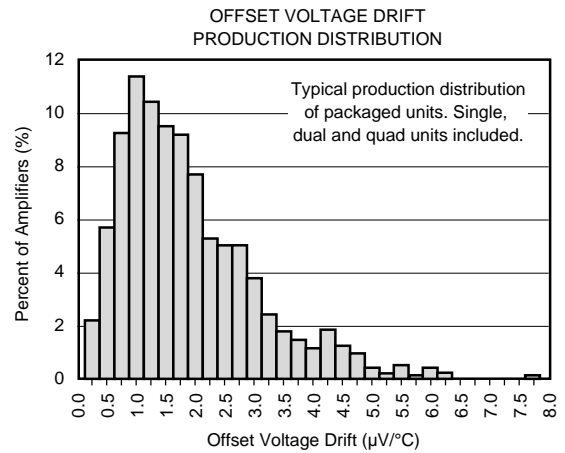
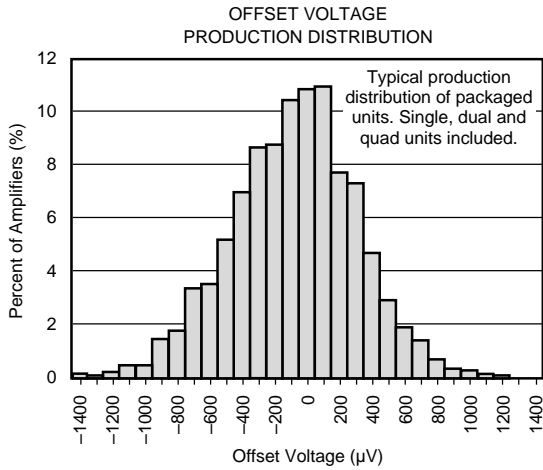
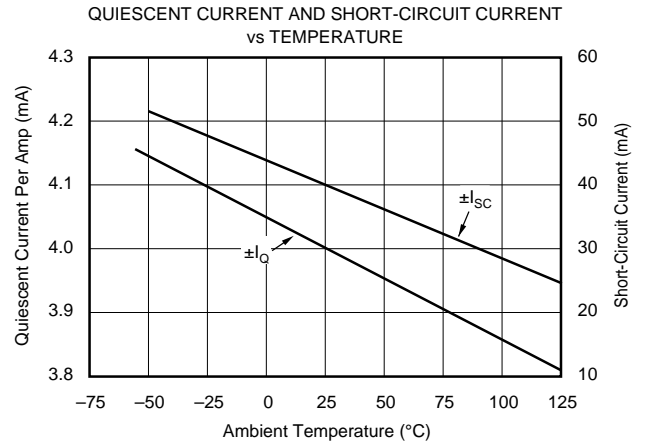
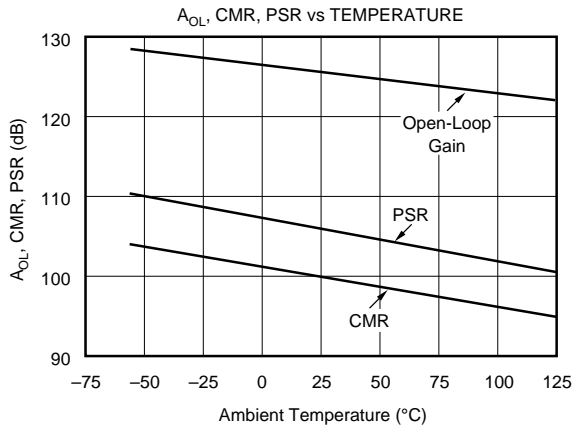

TYPICAL PERFORMANCE CURVES (CONT)

At $T_A = +25^\circ\text{C}$, $V_S = \pm 15\text{V}$, $R_L = 2\text{k}\Omega$, unless otherwise noted.

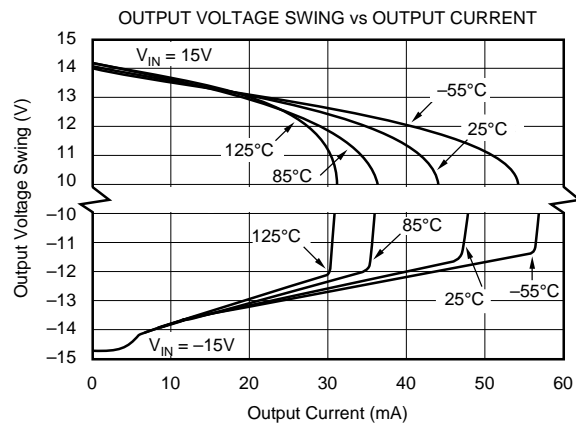
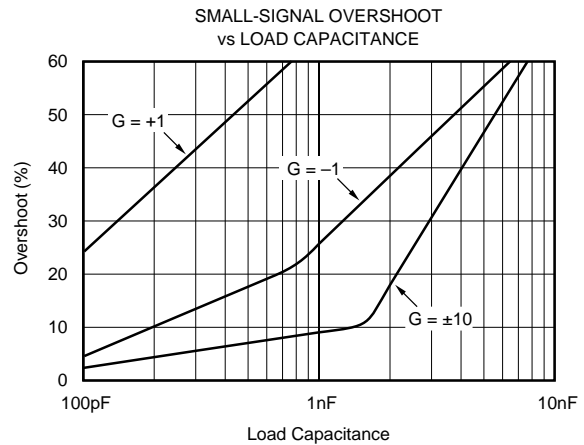
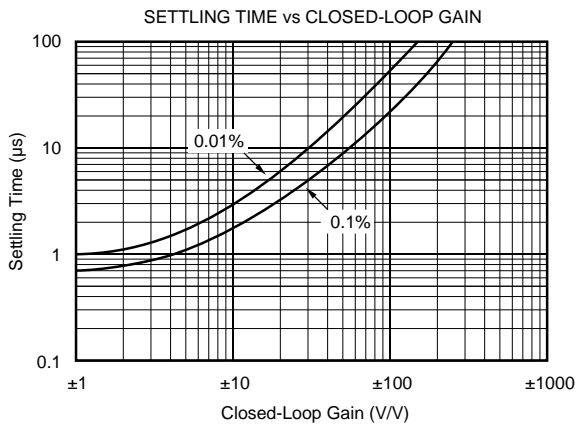
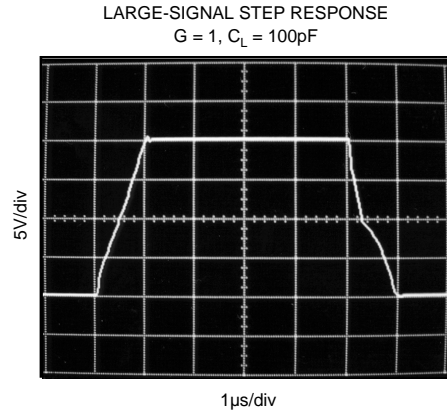
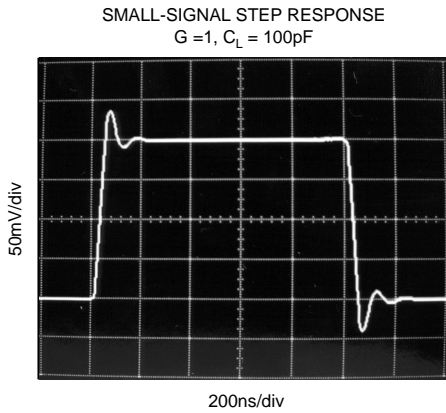

APPLICATIONS INFORMATION

OPA132 series op amps are unity-gain stable and suitable for a wide range of general-purpose applications. Power supply pins should be bypassed with 10nF ceramic capacitors or larger.

OPA132 op amps are free from unexpected output phase-reversal common with FET op amps. Many FET-input op amps exhibit phase-reversal of the output when the input common-mode voltage range is exceeded. This can occur in voltage-follower circuits, causing serious problems in control loop applications. OPA132 series op amps are free from this undesirable behavior. All circuitry is completely independent in dual and quad versions, assuring normal behavior when one amplifier in a package is overdriven or short-circuited.

OPERATING VOLTAGE

OPA132 series op amps operate with power supplies from $\pm 2.5V$ to $\pm 18V$ with excellent performance. Although specifications are production tested with $\pm 15V$ supplies, most behavior remains unchanged throughout the full operating voltage range. Parameters which vary significantly with operating voltage are shown in the typical performance curves.

OFFSET VOLTAGE TRIM

Offset voltage of OPA132 series amplifiers is laser trimmed and usually requires no user adjustment. The OPA132 (single op amp version) provides offset voltage trim connections on pins 1 and 8. Offset voltage can be adjusted by connecting a potentiometer as shown in Figure 1. This adjustment should be used only to null the offset of the op amp, not to adjust system offset or offset produced by the signal source. Nulling offset could degrade the offset voltage drift behavior of the op amp. While it is not possible to predict the exact change in drift, the effect is usually small.

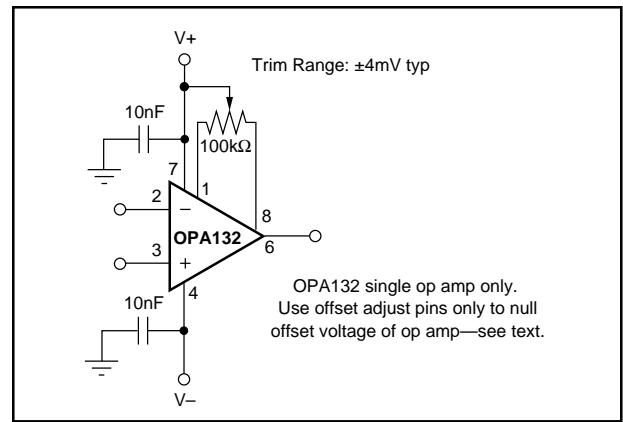

FIGURE 1. OPA132 Offset Voltage Trim Circuit.

INPUT BIAS CURRENT

The FET-inputs of the OPA132 series provide very low input bias current and cause negligible errors in most applications. For applications where low input bias current is crucial, junction temperature rise should be minimized. The input bias current of FET-input op amps increases with temperature as shown in the typical performance curve “Input Bias Current vs Temperature.”

The OPA132 series may be operated at reduced power supply voltage to minimize power dissipation and temperature rise. Using $\pm 3V$ supplies reduces power dissipation to one-fifth that at $\pm 15V$.

The dual and quad versions have higher total power dissipation than the single, leading to higher junction temperature. Thus, a warmed-up quad will have higher input bias current than a warmed-up single. Furthermore, an SOIC will generally have higher junction temperature than a DIP at the same ambient temperature because of a larger θ_{JA} . Refer to the specifications table.

Circuit board layout can also help minimize junction temperature rise. Temperature rise can be minimized by soldering the devices to the circuit board rather than using a socket. Wide copper traces will also help dissipate the heat by acting as an additional heat sink.

Input stage cascode circuitry assures that the input bias current remains virtually unchanged throughout the full input common-mode range of the OPA132 series. See the typical performance curve “Input Bias Current vs Common-Mode Voltage.”